

LINK:
CONTENT & A-Z



The Ultimate
Driving Machine®



OWNER'S MANUAL

BMW 3 SERIES SEDAN.



WELCOME TO BMW.

Owner's Manual.

Thank you for choosing a BMW.

The more familiar you are with your vehicle, the better control you will have on the road. We therefore strongly suggest:

Read this Owner's Manual before starting off in your new BMW. Also use the Integrated Owner's Manual in your vehicle. It contains important notes on vehicle operation that will help you make full use of the technical features available in your BMW. The manual also contains information designed to enhance operating reliability and traffic safety, and to contribute to maintaining the value of your BMW.

At the time of production at the plant, the printed Owner's Manual is the most current resource. After a vehicle software update – such as, a Remote Software Upgrade – the Integrated Owner's Manual for the vehicle will contain the latest information.

You can find supplementary information in the additional brochures in the vehicle literature.

We wish you a safe and enjoyable ride.

TABLE OF CONTENTS

After a vehicle software update – such as, a Remote Software Upgrade – the Integrated Owner's Manual for the vehicle will contain the latest information.

! NOTES

| | |
|----------------------------|----|
| Information | 6 |
| Owner's Manual media | 14 |

⚡ QUICK REFERENCE

| | |
|----------------------|----|
| Entering | 16 |
| Set-up and use | 20 |
| On the road | 24 |

↓ CONTROLS

| | |
|---|-----|
| Dashboard | 32 |
| Sensors of the vehicle | 37 |
| Operating state of the vehicle | 41 |
| iDrive | 44 |
| BMW Remote Software Upgrade | 59 |
| General settings | 63 |
| Personal settings | 68 |
| Connections | 73 |
| Opening and closing | 82 |
| Seats, mirrors and steering wheel | 109 |
| Transporting children safely | 124 |
| Driving | 130 |
| Displays | 148 |
| Lights | 171 |
| Safety | 179 |
| Driving stability control systems | 212 |
| Driver assistance systems | 216 |
| Driving comfort | 265 |
| Climate control | 266 |

| | |
|----------------------------|-----|
| Interior equipment | 282 |
| Storage compartments | 292 |
| Cargo area | 296 |

DRIVING TIPS

| | |
|---------------------------------------|-----|
| Things to remember when driving | 302 |
| Saving fuel | 307 |

MOBILITY

| | |
|----------------------------|-----|
| Refueling | 314 |
| Wheels and tires | 316 |
| Engine compartment | 347 |
| Operating materials | 350 |
| Maintenance | 357 |
| Replacing components | 359 |
| Breakdown Assistance | 364 |
| Vehicle Care | 371 |

REFERENCE

| | |
|------------------------------|-----|
| Technical data | 376 |
| Appendix | 379 |
| Everything from A to Z | 380 |

© 2021 Bayerische Motoren Werke

Aktiengesellschaft

Munich, Germany

Reprinting, including excerpts, only with the written consent of BMW AG, Munich.

US English ID7 VI/21, -

Printed on environmentally friendly paper, bleached without chlorine, suitable for recycling.

Information

Using this Owner's Manual

Orientation

The fastest way to find information on a particular topic is by using the index.

An initial overview of the vehicle is provided in the first chapter.

Validity of the Owner's Manual

Production of the vehicle

At the time of production at the plant, the printed Owner's Manual is the most current resource. Due to updates after the editorial deadline, differences may exist between the printed Owner's Manual and the Integrated Owner's Manual in the vehicle.

Notes on updates can be found in the appendix of the printed Owner's Manual for the vehicle.

After a software update in the vehicle

After a vehicle software update, such as via Remote Software Upgrade, the Integrated Owner's Manual for the vehicle will contain the latest information.

Owner's Manual for Navigation, Entertainment, Communication

The Owner's Manual for Navigation, Entertainment, and Communication can be obtained as a printed book from the service center.

The topics are also discussed in the Integrated Owner's Manual in the vehicle.

Additional sources of information

Service center

A service center will be glad to answer questions at any time.

Internet

Vehicle information and general information on BMW, for instance, on technology, are available on the Internet: www.bmwusa.com.

Integrated Owner's Manual in the vehicle

The Integrated Owner's Manual specifically describes features and functions found in the vehicle. The Integrated Owner's Manual can be displayed on the Control Display.

BMW Driver's Guide app



The BMW Driver's Guide app specifically describes features and functions found in the vehicle. The app can be displayed on smartphones and tablets.

BMW Driver's Guide Web

Driver's Guide Web shows the most suitable information for the selected vehicle. If possible, only equipment and functions that are actually installed in the vehicle will be explained. Driver's Guide Web can be displayed in any current browser.

Symbols and displays

Symbols in the Owner's Manual

| Icon | Meaning |
|--|---|
|  | Precautions that must be followed in order to avoid the possibility of injury to yourself and to others as well as serious damage to the vehicle. |
|  | Measures that can be taken to help protect the environment. |
| "..." | Texts in vehicle used to select individual functions. |
| >...< | Verbal instructions to use with the voice activation system. |
| >...<< | Responses generated by the voice activation system. |

Action steps

Action steps to be carried out are presented as a numbered list. The steps must be carried out in the defined order.

1. First action step.
2. Second action step.

Enumerations

Enumerations without mandatory order or alternative possibilities are presented as a list with bullet points.

- First possibility.
- Second possibility.

Icons on vehicle components

 This symbol on a vehicle component indicates that further information on the component is available in the Owner's Manual.

Vehicle equipment and options

This Owner's Manual describes all models and all standard, country-specific and optional equipment that is offered in the model series. Therefore, this Owner's Manual also describes and illustrates features and functions that are not available in a vehicle, for example because of the selected optional equipment or the country-specific version.

This also applies to safety-related functions and systems.

When using these functions and systems, the applicable laws and regulations must be observed.

For any options and equipment not described in this Owner's Manual, refer to the Supplementary Owner's Manuals.

Your BMW service center is happy to answer any questions that you may have about the features and options applicable to your vehicle.

Status of the Owner's Manual

Basic information

The manufacturer of your vehicle pursues a policy of constant development that is conceived to ensure that our vehicles continue to embody the highest quality and safety standards. In rare cases, therefore, the features described in this Owner's Manual may differ from those in your vehicle.

Validity of the Owner's Manual

Production of the vehicle

At the time of production at the plant, the printed Owner's Manual is the most current resource. Due to updates after the editorial deadline, differences may exist between the printed Owner's

Manual and the Integrated Owner's Manual in the vehicle.

Notes on updates can be found in the appendix of the printed Owner's Manual for the vehicle.

After a software update in the vehicle

After a vehicle software update, such as via Remote Software Upgrade, the Integrated Owner's Manual for the vehicle will contain the latest information.

For Your Own Safety

Intended use

Heed the following when using the vehicle:

- ▷ Owner's Manual.
- ▷ Information on the vehicle. Do not remove stickers.
- ▷ Technical vehicle data.
- ▷ The traffic, speed, and safety laws where the vehicle is driven.
- ▷ Vehicle documents and statutory documents.

Warranty

Your vehicle is technically configured for the operating conditions and registration requirements applying in the country of first delivery, also known as homologation. If your vehicle is to be operated in a different country it might be necessary to adapt your vehicle to potentially differing operating conditions and registration requirements. Noncompliance with homologation requirements in a certain country may affect warranty coverage. Please consult the New Vehicle Limited Warranty Booklet for further information on warranty matters.

Maintenance and repairs

Advanced technology, for instance the use of modern materials and high-performance elec-

tronics, requires suitable maintenance and repair work.

The manufacturer of the vehicle recommends that you entrust corresponding procedures to a BMW center. If you choose to use another service facility, BMW recommends use of a facility that performs work, e.g., maintenance and repair, according to BMW specifications with properly trained personnel, referred to in the Owner's Manual as "another qualified service center or repair shop".

If work is performed improperly, for instance maintenance and repair, there is a risk of subsequent damage and related safety risks.

Improperly performed work on the vehicle paintwork can lead to a failure or fault of components, e.g., the radar sensors, and thereby result in a safety risk.

Parts and accessories

BMW recommends the use of parts and accessory products approved by BMW.

Approved parts and accessories, and advice on their use and installation are available from a BMW center.

BMW parts and accessories have been tested by BMW for their safety and suitability in BMW vehicles.

BMW warrants genuine BMW parts and accessories.

BMW does not evaluate whether each individual product from another manufacturer can be used with BMW vehicles without presenting a safety hazard, even if a country-specific official approval was issued. BMW does not evaluate whether these products are suitable for BMW vehicles under all usage conditions.

California Proposition 65 Warning

For vehicles sold in California, the law requires vehicle manufacturers to provide the following warning:

Warning

Engine exhaust and a wide variety of Automobile components and parts, including components found in the interior furnishings in a vehicle, contain or emit chemicals known to the State of California to cause cancer and birth defects and reproductive harm. In addition, certain fluids contained in vehicles and certain products of component wear contain or emit chemicals known to the State of California to cause cancer and birth defects or other reproductive harm. Battery posts, terminals and related accessories contain lead and lead compounds. Batteries also contain other chemicals known to the State of California to cause cancer. Wash your hands after handling. Used engine oil contains chemicals that have caused cancer in laboratory animals. Always protect your skin by washing thoroughly with soap and water. For more information go to www.P65Warnings.ca.gov/passenger-vehicle.

Warning

Operating, servicing and maintaining a passenger vehicle or off-highway motor vehicle can expose you to chemicals including engine exhaust, carbon monoxide, phthalates, and lead, which are known to the State of California to cause cancer and birth defects or other reproductive harm. To minimize exposure, avoid breathing exhaust, do not idle the engine except as necessary, service your vehicle in a well-ventilated area and wear gloves or wash your hands frequently when servicing your vehicle. For more information go to www.P65Warnings.ca.gov/passenger-vehicle.

Service and warranty

We recommend that you read this publication thoroughly. Your vehicle is covered by the following warranties:

- ▷ New Vehicle Limited Warranty.
- ▷ Rust Perforation Limited Warranty.
- ▷ Federal Emissions System Defect Warranty.
- ▷ Federal Emissions Performance Warranty.
- ▷ California Emission Control System Limited Warranty.

Detailed information about these warranties is listed in the New Vehicle Limited Warranty Booklet.

Your vehicle has been specifically adapted and designed to meet the particular operating conditions and homologation requirements in your country and continental region in order to deliver the full driving pleasure while the vehicle is operated under those conditions. If you wish to operate your vehicle in another country or region, you may be required to adapt your vehicle to meet different prevailing operating conditions and homologation requirements. You should also be aware of any applicable warranty limitations or exclusions for such country or region. In such case, please contact Customer Relations for further information.

Maintenance

Maintain the vehicle regularly to sustain the road safety, operational reliability and the New Vehicle Limited Warranty.

Specifications for maintenance measures:

- ▷ BMW Maintenance system.
- ▷ Maintenance Booklet, available online and accessible via a QR code in the New Vehicle Limited Warranty Booklet.
- ▷ Warranty and Service Guide Booklet for Canadian models.

If the vehicle is not maintained or is improperly maintained, this could result in serious damage to the vehicle.

A failure to maintain your vehicle or improper maintenance may affect your warranty coverage. Please consult the New Vehicle Limited Warranty Booklet for further information on warranty matters.

Refer to section on engine oil change regarding recommended service intervals for oil changes.

Data memory

General information

Electronic control devices are installed in the vehicle. Electronic control units process data they receive from vehicle sensors, self-generate or exchange with each other. Some control units are necessary for the vehicle to function safely or provide assistance during driving, for instance driver assistance systems. Furthermore, control units facilitate comfort or infotainment functions. Information about stored or exchanged data can be requested from the manufacturer of the vehicle, in a separate booklet, for example.

Personal reference

Each vehicle is marked with a unique vehicle identification number. Depending on the country, the vehicle owner can be identified with the vehicle identification number, license plate and corresponding authorities. In addition, there are other options to track data collected in the vehicle to the driver or vehicle owner, for instance, via the ConnectedDrive account that is used.

Operating data in the vehicle

Control units process data to operate the vehicle. For example, this includes:

- ▶ Status messages for the vehicle and its individual components, e.g., wheel rotational speed, wheel speed, deceleration, lateral acceleration, engaged safety belt indicator.
- ▶ Ambient conditions, e.g., temperature, rain sensor signals.

The processed data is only processed in the vehicle itself and generally volatile. The data is not stored beyond the operating period.

Electronic components, e.g. control units and vehicle keys, contain components for storing technical information.

Information about the vehicle condition, component usage, maintenance recommendations, events or faults can be stored temporarily or permanently.

This information generally documents the state of a component, a module, a system, or the surrounding area, for instance:

- ▶ Operating states of system components, for instance, fill levels, tire pressure, battery status.
- ▶ Malfunctions and faults in important system components, for instance lights and brakes.
- ▶ Responses by the vehicle to special driving situations such as airbag deployment or engagement of the driving stability control systems.
- ▶ Information on vehicle-damaging events.

The data is required to perform the control unit functions. Furthermore, it also serves to detect and correct malfunctions, and helps the vehicle manufacturer to optimize vehicle functions.

The majority of this data is stored temporarily and is only processed within the vehicle itself. In some circumstances the vehicle may store some data for an additional but limited period of time.

When servicing, for instance during repairs, service processes, warranty cases, and quality assurance measures, this technical information can be read out from the vehicle together with the vehicle identification number.

A dealer's service center or another qualified service center or repair shop can read out the information. The socket for OBD Onboard Diagnosis required by law in the vehicle is used to read out the data.

The data is collected, processed, and used by the relevant organizations in the service network. The data documents technical conditions of the vehicle, which can be used to determine vehicle maintenance status, and facilitate quality improvement.

Fault and event memories in the vehicle can be reset when a dealer's service center or another

qualified service center or repair shop performs repair or servicing work.

Data entry and data transmission into the vehicle

General information

Depending on the vehicle equipment, comfort and individual settings can be stored in the vehicle and modified or reset at any time.

For example, this includes:

- ▶ Settings for the seat and steering wheel positions.
- ▶ Chassis and climate control settings.

If necessary, data can be transferred to the entertainment and communication system of the vehicle, for instance via smartphone.

This includes the following depending on the respective equipment:

- ▶ Multimedia data such as music, films or photos for playback in an integrated multimedia system.
- ▶ Address book data for use in conjunction with an integrated hands-free system or an integrated navigation system.
- ▶ Entered navigation destinations.
- ▶ Data on the use of Internet services.

This data can be stored locally in the vehicle or is found on a device that has been connected to the vehicle, e.g., a smartphone, USB stick or MP3 player. If this data is stored in the vehicle, it can be deleted at any time.

This data is only transmitted to third parties upon personal request as part of the use of online services. The transmission depends on the selected settings for the use of the services.

Incorporation of mobile devices

Depending on the vehicle equipment, mobile devices connected to the vehicle, for instance smartphones, can be controlled via the vehicle control elements.

The sound and picture from the mobile device can be played back and displayed through the multimedia system. Certain information is transferred to the mobile device at the same time. Depending on the type of incorporation, this includes, for instance position data and other general vehicle information. This optimizes the way in which selected apps, for instance navigation or music playback, work.

There is no further interaction between the mobile device and the vehicle, such as active access to vehicle data.

How the data will be processed further is determined by the provider of the particular app being used. The extent of the possible settings depends on the respective app and the operating system of the mobile device.

Services

General information

If the vehicle has a wireless network connection, this enables data to be exchanged between the vehicle and other systems. The wireless network connection is realized via an in-vehicle transmitter and receiver unit or via personal mobile devices brought into the vehicle, for instance smartphones. This wireless network connection enables 'online functions' to be used. These include online services and apps supplied by the vehicle manufacturer or by other providers.

Services from the vehicle manufacturer

Where online services from the vehicle manufacturer are concerned, the corresponding functions are described in the appropriate place, for instance the Owner's Manual or manufacturer's website. The relevant legal information pertaining to data protection may also be found on the manufacturer's website. Personal data may be used to perform online services. Data is exchanged over a secure connection, for instance with the IT systems of the vehicle manufacturer intended for this purpose.

Any collection, processing, and use of personal data above and beyond that needed to provide the services must always be based on a legal permission, contractual arrangement or consent. It is also possible to activate or deactivate the data connection as a whole. That is, with the exception of functions and services required by law such as Assist systems.

Services from other providers

When using online services from other providers, these services are the responsibility of the relevant provider and subject to their data privacy conditions and terms of use. The vehicle manufacturer has no influence on the content exchanged during this process. Information on the way in which personal data is collected and used in relation to services from third parties, the scope of such data, and its purpose, can be obtained from the relevant service provider.

Event Data Recorder EDR

This vehicle is equipped with an event data recorder EDR. The main purpose of an EDR is to record, in certain crash or near crash-like situations, such as an air bag deployment or hitting a road obstacle, data that will assist in understanding how a vehicle's systems performed. The EDR is designed to record data related to vehicle dynamics and safety systems for a short period of time, typically 30 seconds or less.

The EDR in this vehicle is designed to record such data as:

- ▶ How various systems in your vehicle were operating.
- ▶ Whether or not the driver and passenger safety belts were fastened.
- ▶ How far, if at all, the driver was depressing the accelerator and/or brake pedal.
- ▶ How fast the vehicle was traveling.

This data can help provide a better understanding of the circumstances in which crashes and injuries occur.

EDR data is recorded by your vehicle only if a nontrivial crash situation occurs; no data is recorded by the EDR under normal driving conditions and no personal data, for instance name, gender, age, and crash location, are recorded.

However, other parties, such as law enforcement, could combine the EDR data with the type of personally identifying data routinely acquired during a crash investigation.

To read data recorded by an EDR, special equipment is required, and access to the vehicle or the EDR is needed. In addition to the vehicle manufacturer, other parties, such as law enforcement, that have the special equipment, can read the information if they have access to the vehicle or the EDR.

Vehicle identification number

General information

Depending on the national-market version, the vehicle identification number is located in different positions in the vehicle. This chapter describes all possible positions for the series.

Engine compartment



The engraved vehicle identification number can be found in the engine compartment, on the right-hand side of the vehicle.

Right nameplate



The vehicle identification number can be found on the nameplate, on the right-hand side of the vehicle.

Left nameplate



The vehicle identification number can be found on the nameplate, on the left-hand side of the vehicle.

Windshield



The vehicle identification number can also be found behind the windshield.

iDrive

It is also possible to display the vehicle identification number via iDrive.

Additional information:

Displaying the vehicle identification number and software part number, refer to page 74.

Reporting safety defects

For US customers

The following only applies to vehicles owned and operated in the US.

If you believe that your vehicle has a defect which could cause a crash or could cause injury or death, you should immediately inform the National Highway Traffic Safety Administration NHTSA, in addition to notifying BMW of North America, LLC, P.O. Box 1227, Westwood, New Jersey 07675-1227, Telephone 1-800-831-1117.

If NHTSA receives similar complaints, it may open an investigation, and if it finds that a safety defect exists in a group of vehicles, it may order a recall and remedy campaign.

However, NHTSA cannot become involved in individual problems between you, your dealer, or BMW of North America, LLC.

To contact NHTSA, you may call the Vehicle Safety Hotline toll-free at 1-888-327-4236 (TTY: 1-800-424-9153); go to <http://www.safercar.gov>; or write to: Administrator, NHTSA, 1200 New Jersey Avenue, SE., Washington, DC 20590.

You can also obtain other information about motor vehicle safety from <http://www.safercar.gov>.

For Canadian customers

Canadian customers who wish to report a safety-related defect to Transport Canada, Defect Investigations and Recalls, may call the toll-free hotline 1-800-333-0510. You can also obtain other information about motor vehicle safety from <http://www.tc.gc.ca/roadsafety>.

Owner's Manual media

Vehicle features and options

This chapter describes all standard, country-specific and optional features offered with the series. It also describes features and functions that are not necessarily available in your vehicle, e.g., due to the selected options or country versions. This also applies to safety-related functions and systems. When using these functions and systems, the applicable laws and regulations must be observed.

General information

Media at a glance

You can use various media formats to call up the content in the Owner's Manual. The following Owner's Manual media formats are available:

- ▷ Printed Owner's Manual.
- ▷ Integrated Owner's Manual in the vehicle.

Validity of the Owner's Manual

Production of the vehicle

At the time of production at the plant, the printed Owner's Manual is the most current resource. Due to updates after the editorial deadline, differences may exist between the printed Owner's Manual and the Integrated Owner's Manual in the vehicle.

Notes on updates can be found in the appendix of the printed Owner's Manual for the vehicle.

After a software update in the vehicle

After a vehicle software update, such as via Remote Software Upgrade, the Integrated Owner's

Manual for the vehicle will contain the latest information.

Printed Owner's Manual

Concept

The printed Owner's Manual describes all standard, country-specific, and optional features offered with the series.

General information

The Owner's Manual for Navigation, Entertainment, and Communication can be obtained as a printed book from the service center.

Supplementary Owner's Manuals

Also follow the Supplementary Owner's Manuals, which are included in addition to the onboard literature.

Integrated Owner's Manual in the vehicle

Principle

The Integrated Owner's Manual specifically describes features and functions found in the vehicle.

The Integrated Owner's Manual can be displayed on the Control Display.

Selecting the Owner's Manual

1.  Press the button.
2. "CAR"
3. "Owner's Manual"
4. Select the desired method of accessing the contents.

Scrolling through the Owner's Manual

Turn the Controller, until the next or previous contents are displayed.

Context help

General information

The Integrated Owner's Manual can be accessed from any menu. Depending on the selected function, either the associated description or the main menu of the Integrated Owner's Manual will be displayed.

Opening via iDrive

Change directly to the Options menu from the function on the Control Display:

1.  Press the button.
2. "Help"

Opening when a Check Control message is displayed

Directly from the Check Control message on the Control Display:

1.  "Owner's Manual"

Entering

Opening and closing

Buttons on the vehicle key

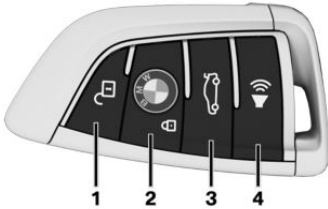

- 1 Unlocking
- 2 Locking
- 3 Opening the trunk lid
- 4 Panic mode, pathway lighting

Unlocking the vehicle

 Press the button on the vehicle key.

Depending on the settings, either only the driver's door or all vehicle access points are unlocked.

If only the driver's door is unlocked, press the button on the vehicle key again to unlock the other vehicle access points.

 Press and hold the button on the vehicle key after unlocking.

The windows and the glass sunroof are opened, as long as the button on the vehicle key is pressed.

Locking the vehicle

1. Close the driver's door.
2.  Press the button on the vehicle key.
All vehicle access points are locked.

Buttons for the central locking system

Overview



Buttons for the central locking system.

Locking

 Press the button with the front doors closed.

The fuel filler flap remains unlocked.

Unlocking

 Press the button.

Panic mode

You can trigger the alarm system if you find yourself in a dangerous situation.

 ▶ Press the button on the vehicle key and hold for at least 3 seconds.

▶ Briefly press the button on the vehicle key three times in succession.

To switch off the alarm: press any button.

Comfort Access

Principle

The vehicle can be accessed without operating the vehicle key.

Carrying the vehicle key with you, e.g., in your pants pocket, is sufficient.

The vehicle automatically detects the vehicle key when it is in close proximity or in the car's interior.

Unlocking the vehicle

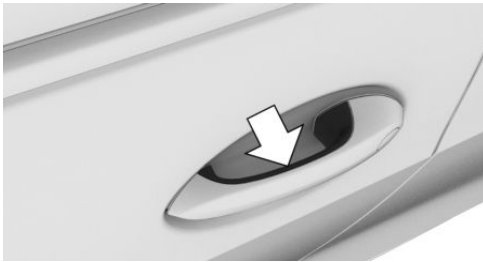

Grasp the handle of a vehicle door completely.

Locking the vehicle

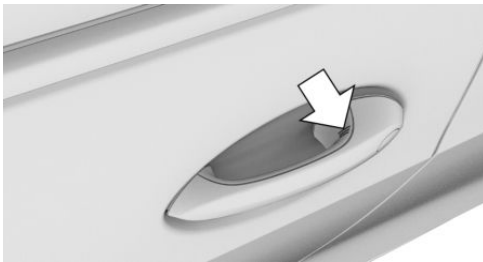

Touch the grooved surface on the handle of a closed vehicle door with your finger for approx. 1 second without grasping the door handle.

Opening and closing the trunk lid with no-touch activation

Principle

The trunk lid can be opened and closed with no-touch activation using the vehicle key you are carrying.

Performing the foot movement

1. Stand in the middle behind the vehicle at approx. one arm's length away from the rear of the vehicle.
2. Wave a foot under the vehicle in the driving direction and immediately pull it back. With this movement, the leg must pass through the ranges of both sensors.



Trunk lid

Opening

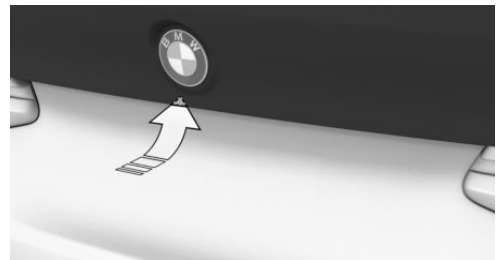

- ▷ Unlock the vehicle and then press the button on the outer side of the trunk lid.
- ▷  Press and hold the button on the vehicle key for approx. 1 second.

Depending on the setting, the doors may also be unlocked.

Without automatic tailgate operation: closing

Close the trunk lid manually.

With automatic tailgate operation: closing



Press the button on the inside of the trunk lid.

Displays, control elements

In the vicinity of the steering wheel

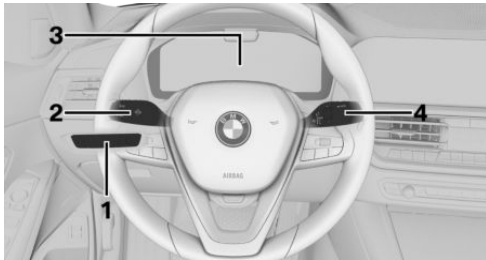

- 1 Light switch element
- 2 Turn signal indicator, high beams
- 3 Instrument cluster
- 4 Wipers

Indicator/warning lights

The indicator/warning lights can light up in a variety of combinations and colors.

Several of the lights are checked for proper functioning and light up temporarily when drive-ready state is turned on.

Driver's door



- 1 Power windows
- 2 Central locking system
- 3 Seats, comfort features
- 4 Exterior mirrors
- 5 Opening/closing trunk lid

Switch console

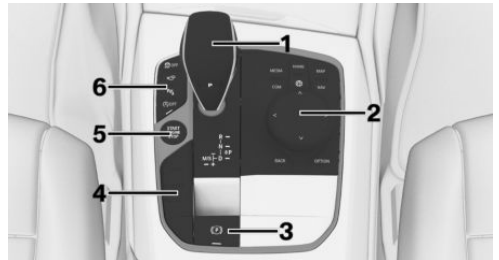





- 1 Selector lever/gearshift lever
- 2 Controller
- 3 Parking brake, Automatic Hold
- 4 Driving Dynamics Control
- 5 Start/Stop button
- 6 Assistance systems

iDrive

Principle

iDrive is the operating concept of the infotainment system and includes a large number of functions.

Buttons on the Controller

| Button | Function |
|--|--|
|  | Go to the main menu. |
|  | Go to Apps menu. |
|  | Go to the Media/Radio menu. |
|  | Go to the Communication menu. |
|  | Go to navigation map. |
|  | Go to destination input menu for navigation. |
|  | Go to the previous display. |
|  | Go to the Options menu. |

Voice control

Activating the voice control system

 Press the button on the steering wheel.

Say the command.

Ending voice control

 Press the button on the steering wheel or >Cancel.

Set-up and use

Seats, mirrors and steering wheel

Manually adjustable seats

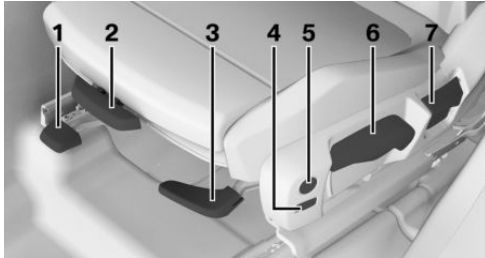

- 1 Longitudinal direction
- 2 Thigh support
- 3 Seat tilt
- 4 Backrest width
- 5 Lumbar support
- 6 Height
- 7 Backrest tilt

Electrically adjustable seats

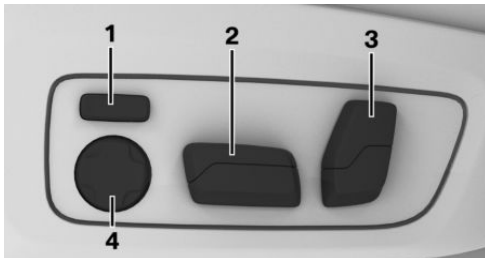

- 1 Backrest width
- 2 Forward/backward, height, seat tilt
- 3 Backrest tilt, head restraint
- 4 Lumbar support

Adjusting the head restraint

Adjusting the height: manual head restraints

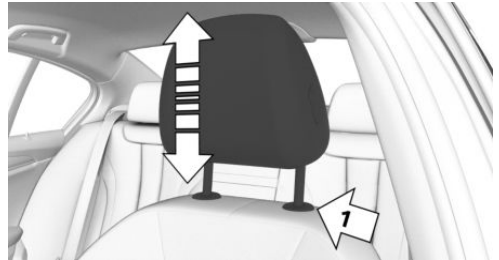

- ▷ To lower: press the button, arrow 1, and push the head restraint down.
- ▷ To raise: push the head restraint up.

After setting the height, make sure that the head restraint engages correctly.

Adjusting the height: electrical head restraints

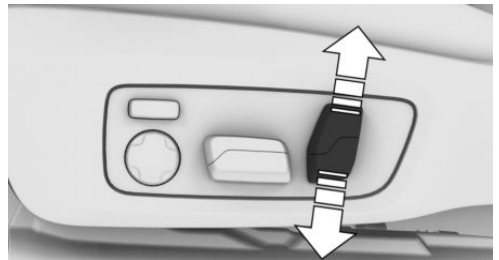

Press switch up or down.

Adjusting distance

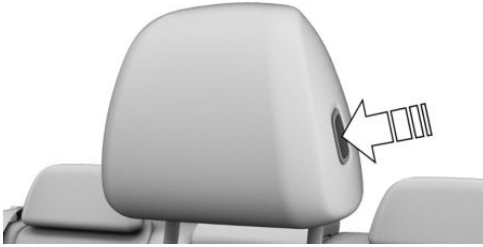

- ▷ Back: press the button and push the head restraint toward the rear.
- ▷ Forward: pull the head restraint toward the front.

After setting the distance, make sure that the head restraint engages correctly.

Adjusting the distance: M Sport seat

The distance to the back of the head is adjusted via the backrest tilt.

Adjusting the exterior mirrors

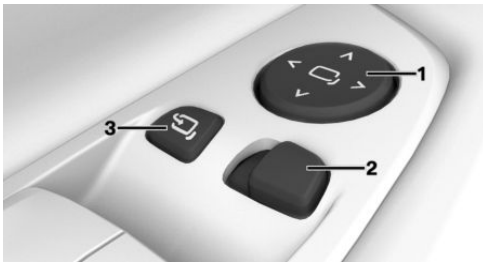

- 1 Adjusting
- 2 Selecting a mirror, Automatic Curb Monitor
- 3 Folding in and out

Adjusting the steering wheel

Manual steering wheel adjustment

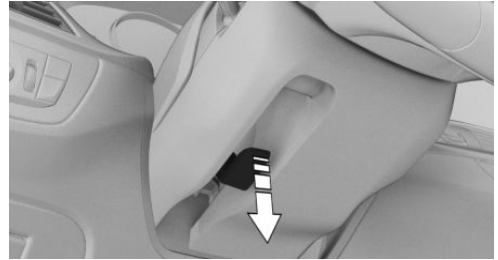

1. Fold the lever down.
2. Move the steering wheel to the preferred height and angle to suit your seat position.
3. Fold the lever back up.

Memory function

Principle

The following settings can be stored and, if necessary, retrieved using the memory function:

- ▷ Seat position.
- ▷ Exterior mirror position.
- ▷ Height of the Head-up Display.

Storing

1. Set the desired position.
2. **SET** Press the button. The writing on the button lights up.
3. Press the desired button 1 or 2 at the door while the writing is lit. A signal sounds.

Calling up settings









Press the desired button 1 or 2.

Infotainment

Radio



Buttons and functions

Depending on the country and equipment version, the radio has the following buttons.

| Button | Function |
|--|--|
|  | Press: turns sound output on/off. Turn: adjusts the volume. |
|  | Change the entertainment source. |
|  | Press once: changes the station/track. / Press and hold: fast forward/rewind the track. |
|  | |
|  | Programmable memory buttons. |
|  | |
|  | Changeover of waveband/satellite radio. |
|  | Menu Apps. |

Navigation destination input

Entering a destination via the search

-  Press the button on the Controller.
-  "Where to?"
- Enter at least two letters or characters.
Select point of interest categories from the points of interest menu as needed.

The search term may be completed automatically in orange lettering.

Move the Controller up to accept the suggested search term.

- OK** Select the icon, if needed.
A list of the results is displayed.
- If necessary, "Filter"
- "Show results"
- Select the desired entry.
- If necessary, "Start guidance"

Connecting a mobile phone

General information

After the mobile phone is connected once to the vehicle, the mobile phone can be operated using iDrive and the steering wheel buttons.

Connecting the mobile phone via Bluetooth

- "COM"
- "Mobile devices"
- Tilt the Controller to the right.
- "New device"
- "Phone calls and audio"

The vehicle's Bluetooth name is displayed on the Control Display.



- Compare the control number displayed on the Control Display with the control number on the display of the mobile device, and confirm that the two match.
- A Bluetooth connection is established.

The mobile device is connected to the vehicle and displayed in the device list.

Using the telephone

Accepting a call

Depending on the equipment, incoming calls can be answered in several ways.

- ▷ Via iDrive:
 -  "Accept"
- ▷  / 

Press the corresponding button on the steering wheel.
- ▷ Via the selection list in the instrument cluster:

Use the thumbwheel on the steering wheel to select: "Accept"
- ▷ Via touchscreen: tap on the corresponding entry on the Control Display.

Dialing a number

1. "COM"
2. If necessary, "Telephone"
3. "Dial number:"
4. Enter the numbers.
5.  Select the icon. The connection is established via the mobile phone to which this function has been assigned.

Establish the connection via the additional telephone:

1.  Press the button.
2. "Call via"

Apple CarPlay® preparation

Principle

CarPlay allows certain functions of a compatible Apple iPhone to be used via Siri voice control and iDrive.

Functional requirements

- ▷ Compatible iPhone, iPhone 5 or later with iOS 7.1 or later.
- ▷ Corresponding mobile contract.
- ▷ If necessary, the setting for mobile data must be activated on the iPhone.

- ▷ Bluetooth, WLAN, and Siri voice control are activated on the iPhone.
- ▷ WLAN is activated on the vehicle.

Pairing the iPhone with CarPlay

1. "COM"
2. "Mobile devices"
3. "New device"
4. "Phone calls and audio"

The vehicle's Bluetooth name is displayed on the Control Display.
5. On the mobile device, search for Bluetooth devices in the vicinity and select the vehicle.

A control number is displayed.
6. Compare the control number displayed on the Control Display with the control number on the display of the mobile device, and confirm that the two match.
7. "Use Apple CarPlay"

The iPhone is connected to the vehicle and displayed in the device list.

On the road

Driving

Drive readiness

Turning on drive readiness



1. Depress the brake pedal.
2. Press the Start/Stop button.

Turning off drive-ready state

Steptronic transmission:

1. Engage selector lever position P with the vehicle stopped.
2. Press the Start/Stop button.
The engine is switched off.
3. Set the parking brake.

Auto Start/Stop function

The Auto Start/Stop function switches the engine off automatically while stationary to save fuel. The engine starts automatically under the following preconditions:

Steptronic transmission:

- ▷ By releasing the brake pedal.
- ▷ When Automatic Hold is activated: step on the accelerator pedal.

Parking brake

Setting



Pull the switch.

The LED on the switch and the indicator light in the instrument cluster are illuminated.

Releasing



With drive-ready state switched on:

Steptronic transmission: press the switch while the brake is pressed or selector lever position P is set.

The LED and indicator light turn off.

The parking brake is released.

Steptronic transmission: parking

The parking brake is automatically set if the vehicle is being held by Automatic Hold and the drive-ready state is switched off or the vehicle is exited.

Steptronic transmission

Engaging selector lever position D, N, R

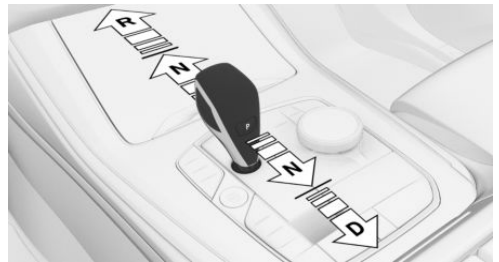

- ▷ Gear position D.
- ▷ Neutral N.
- ▷ R is reverse.

With the driver's safety belt fastened, briefly push the selector lever in the desired direction, past a resistance point, if needed. The selector lever returns to the center position in each case.

To prevent the vehicle from creeping after you select a gear position or reverse, maintain pressure on the brake pedal until you are ready to start.

A selector lever lock prevents the inadvertent shifting to selector lever position R or the inadvertent shifting from selector lever position P. Engage selector lever position R only when the vehicle is stationary.

Releasing the selector lever lock

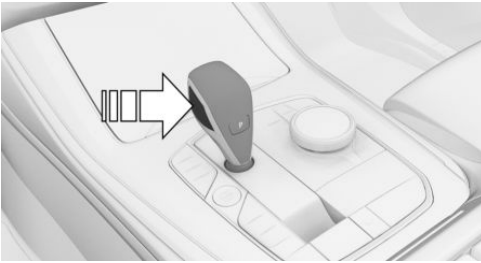

Press the button.

Engaging P

Engage selector lever position P only when the vehicle is stationary.



Press button P.

Steptronic transmission, Sport program and manual mode

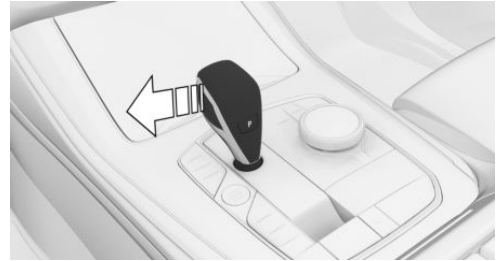

Activate the Sport program/manual mode:

Press the selector lever to the left from selector lever position D.

Manual mode:

- ▶ To shift down: press the selector lever forward.
- ▶ To shift up: pull the selector lever rearwards.

End the sport program/manual mode:

Press the selector lever to the right.

Turn signal, high beams, headlight flasher

Turn signal

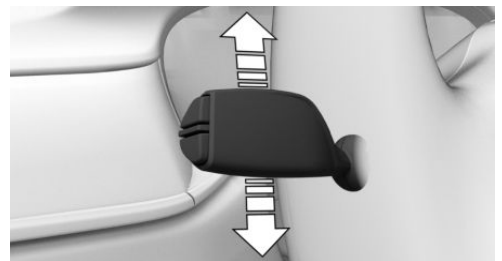

- ▶ Blinking: press the lever past the resistance point.
- ▶ Triple turn signal activation: lightly tap the lever up or down.
- ▶ Brief blinking: press the lever to the resistance point and hold it there for as long as you want the turn signal to blink.

High beams, headlight flasher

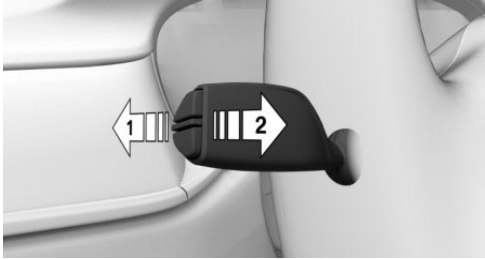

Press the lever forward or pull it backward.

- ▷ High beams on, arrow 1.
The high beams light up when the low beams are switched on.
- ▷ High beams off/headlight flasher, arrow 2.

Lights and lighting

Light functions

| Icon | Function |
|------|---|
| | Front fog lights. |
| | Lights off. Daytime driving lights. |
| | Parking lights. |
| | Automatic headlight control. Adaptive light functions. |
| | Low beams. |
| | Instrument lighting. |

| Icon | Function |
|------|-------------------------------|
| | Right roadside parking light. |
| | Left roadside parking light. |

Window wiper system

Turn on window wiper system

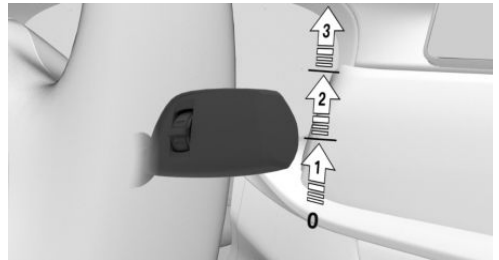

Press the lever up until the desired position is reached.

- ▷ Resting position of the wipers: position 0.
- ▷ Rain sensor: position 1.
- ▷ Normal wiper speed: position 2.
- ▷ Fast wiper speed: position 3.

Turn off the window wiper system and flick wipe

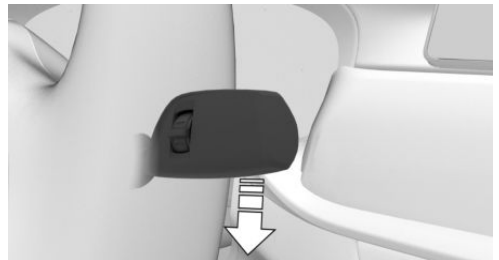

Press the lever down.

- ▶ Turn off: press the lever down until it reaches the 0 position.
- ▶ Flick wipe: press the lever down from the 0 position.

Activate/deactivate rain sensor

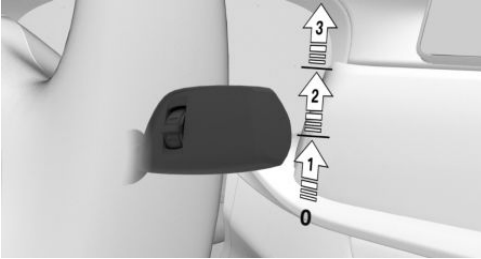

Activate: press the lever up once from its 0 position, arrow 1.

Deactivate: press the lever back into the 0 position.

Adjusting the rain sensor sensitivity

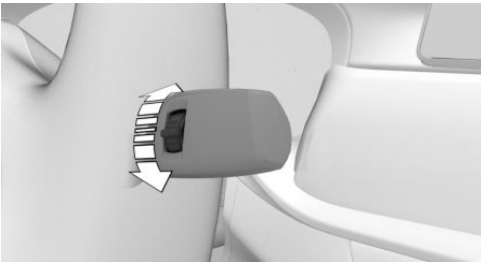

Turn the thumbwheel on the wiper lever.

Cleaning the windshield













Pull the lever.

Climate control

Automatic climate control

| Button | Function |
|--------|---------------------------|
| | Temperature. |
| | Air recirculation mode. |
| | Maximum cooling. |
| | AUTO program. |
| | Air distribution, manual. |
| | Switching off. |
| | Defrost function. |
| | Rear window defroster. |
| | Seat heating. |
| | Air conditioning. |
| | Air flow, manual. |

Automatic climate control with enhanced features

| Button | Function |
|--|--|
|  | Temperature. |
|  | Air recirculation mode. |
|  | Maximum cooling. |
|  | AUTO program. |
|  | Air flow, manual. Switching off. Intensity AUTO program. |
|  | Air distribution, manual. |
|  | Defrost function. |
|  | Rear window defroster. |
|  | Seat heating. |
|  | Air conditioning. Opening the Climate menu. For example, for the following settings: upper body temperature adjustment, pre-ventilation. |

Intermediate stop

Refueling

Fuel cap

1. To open the fuel filler flap, press on the rear edge, arrow. The fuel filler flap opens.



2. Turn the fuel cap counterclockwise.
3. Place the fuel cap in the bracket attached to the fuel filler flap.

Gasoline

For the best fuel efficiency, the gasoline should be sulfur-free or very low in sulfur content.

Fuels that are marked on the gas pump as containing metal must not be used.

Wheels and tires

Tire pressure specifications

The tire inflation pressure specifications can be found in the tire inflation pressure table in the printed Owner's Manual.

After correcting the tire pressure

With runflat tires:

Reinitialize the Flat Tire Monitor.

With Tire Pressure Monitor:

The corrected tire inflation pressures are applied automatically. Make sure that the correct tire settings have been made.

With tires that cannot be found in the tire pressure values on the Control Display, reset the Tire Pressure Monitor TPM.

Checking the tire pressure

Regularly check the tire inflation pressure and correct it as needed:

- At least twice a month.
- Before embarking on an extended trip.

Cleaning the wheels

The friction during hard braking may produce brake dust and make the rims dirty. Brake dust can be removed by cleaning the rims. BMW recommends using vehicle care and cleaning products from BMW.

Electronic oil measurement

Functional requirements

A current measured value is available after approx. 30 minutes of normal driving.

Displaying the engine oil level

1. "CAR"
2. "Vehicle status"
3.  "Engine oil level"

Different messages appear on the Control Display depending on the engine oil level. Pay attention to these messages.

Adding engine oil

General information

Safely park the vehicle and switch off drive-ready state before adding engine oil.

Adding engine oil



Only add engine oil when the message is displayed in the instrument cluster.

Observe the quantity to be added in the message.

Take care not to add too much engine oil.

Observe recommended engine oil types.

Providing assistance

Hazard warning flashers



The button is located in the center console.

Breakdown Assistance

BMW Roadside Assistance

1. "APPS"
2. "Installed apps"
3. "BMW Assist"
4. If necessary, "BMW Roadside Assistance"

A voice connection is established.

ConnectedDrive

Concierge service

The BMW Assist Concierge service offers information on events, filling stations or hotels, and provides phone numbers and addresses. Many hotels can be booked directly by the BMW Concierge service. The Concierge service is part of the optional BMW Assist Response Center.

1. "COM"
2. "BMW Assist"
3. If necessary, select the entry for the Concierge Service.

A voice connection to the Concierge service is established.

Teleservices

Teleservices are services that help to maintain vehicle mobility.

Teleservices can comprise the following services:

- ▷ BMW Roadside Assistance.
- ▷ BMW Accident Assistance.
- ▷ Teleservice Call.
- ▷ Teleservice Report.
- ▷ Teleservice Battery Guard.
- ▷ Your dealer's service center.

Dashboard

Vehicle features and options

This chapter describes all standard, country-specific and optional features offered with the series. It also describes features and functions that are

not necessarily available in your vehicle, e.g., due to the selected options or country versions. This also applies to safety-related functions and systems. When using these functions and systems, the applicable laws and regulations must be observed.

In the vicinity of the steering wheel

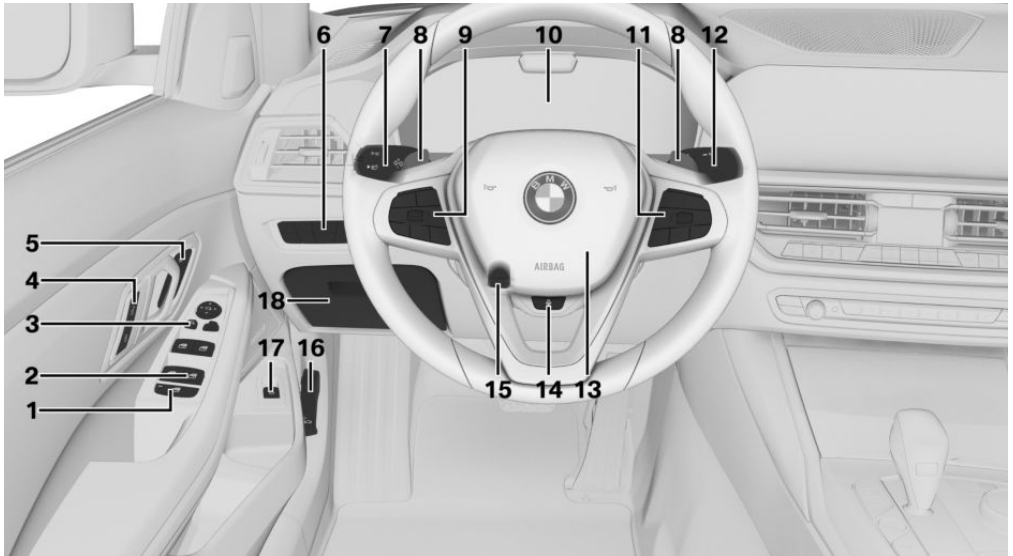

1  Safety switch 106

2  Power windows 105

3 Exterior mirror adjustment button 118

4 Central locking system 93

 Unlocking

 Locking

5 Seating comfort features

 Memory function 121

6 Lights



Front fog lights 176



Light switch 171



Lights off

Daytime driving lights 173



Parking lights 172



Automatic headlight control 171

Adaptive light functions 174

Automatic High Beam Assistant 174



Low beams 172



Instrument lighting 177



Right roadside parking light 172



Left roadside parking light 172

7 Steering column stalk, left



Turn signal 138



High beams, headlight flasher 139



Automatic High Beam Assistant 174



Instrument cluster with enhanced features:

Widgets 150

Instrument cluster without enhanced features:

Widgets 151

Trip data 166

8 Shift paddles 142

9 Steering wheel buttons, left



Manual Speed Limiter 216



Depending on the equipment:
Cruise control on/off 218



Depending on the equipment:
Active Cruise Control on/off 220



With steering and traffic jam assistant 230:

Cruise control, distance control and lane guidance on/off



Cruise control: to store the speed
Speed Limit Assistant: accept suggested speed 228



Pausing cruise control



Continuing cruise control



Active Cruise Control: increase distance



Active Cruise Control: reduce distance

Cruise control rocker switch

10 Instrument cluster 148

11 Steering wheel buttons, right



Selection lists 165



Volume, see Owner's Manual for Navigation, Entertainment and Communication 6



Voice activation system 52



Changing the station/track, see Owner's Manual for Navigation, Entertainment, Communication [6](#)



Telephone, see Owner's Manual for Navigation, Entertainment and Communication [6](#)

Thumbwheel for selection lists [165](#)

12 Steering column stalk, right



Wipers [139](#)



Rain sensor [140](#)



Cleaning the windshield [141](#)

13



Horn, entire surface

14



Steering wheel heating [120](#)

15 Adjusting the steering wheel [120](#)

16



Unlocking the hood [348](#)

17









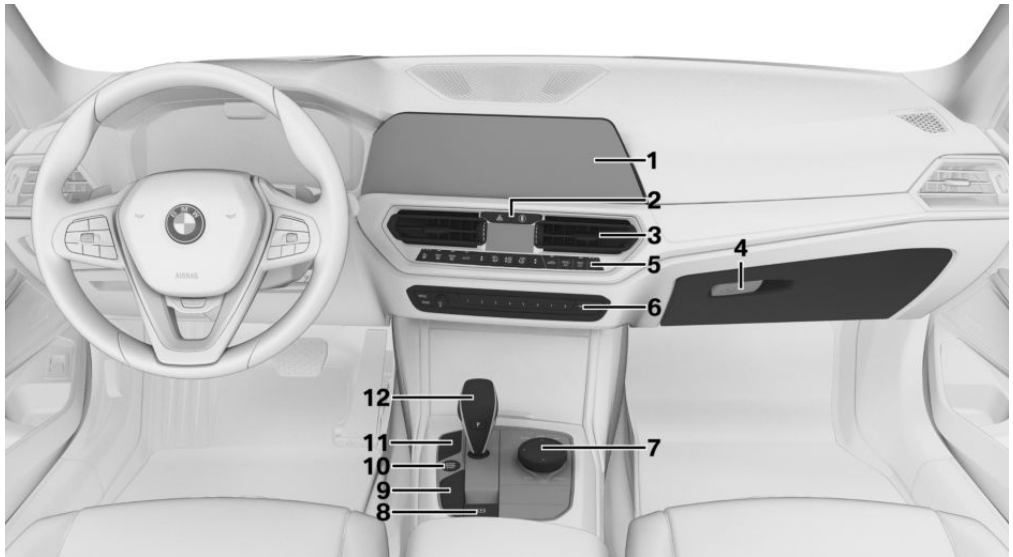





Opening and closing the trunk lid [98](#)

18 Glove compartment [293](#)

In the vicinity of the center console





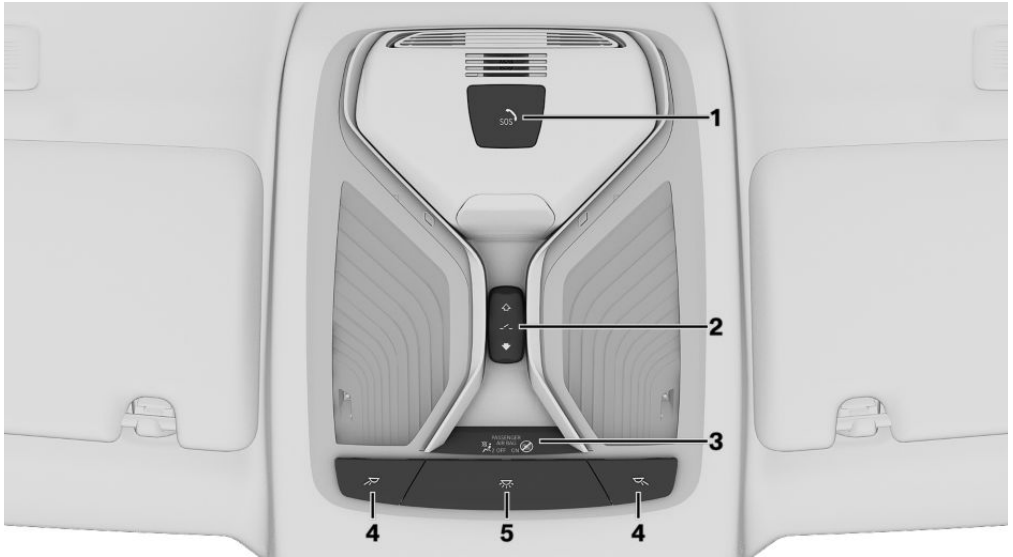

- | | |
|---|---|
| <p>1 Control Display 48</p> | <p>9  Driving Dynamics Control 133 SPORT driving mode</p> |
| <p>2  Hazard warning system 364</p> | <p> COMFORT driving mode</p> |
| <p> Intelligent Safety 183</p> | <p> ECO PRO driving mode</p> |
| <p>3 Ventilation 275</p> | <p> ADAPTIVE driving mode</p> |
| <p>4 Glove compartment 292</p> | <p>10  Turning drive readiness state on/off 130</p> |
| <p>5 Automatic climate control 266 Automatic climate control with enhanced features 270</p> | <p>11  Auto Start/Stop function 130</p> |
| <p>6 Radio/multimedia, see Owner's Manual for Navigation, Entertainment, and Communication 6</p> | <p> Parking assistance systems 239</p> |
| <p>7 Controller with buttons 48</p> | <p> Panorama View 259</p> |
| <p>8  Parking brake 135</p> | <p> DSC Dynamic Stability Control 212</p> |
| <p> Automatic Hold 136</p> | |

12 Steptronic transmission: selector lever [142](#)

In the vicinity of the headliner



- 1  Emergency Call, SOS [366](#)
- 2  Operating the electric glass sun-roof [106](#)
- 3  Indicator light, front passenger air-bag [182](#)

- 4  Reading lights [177](#)
- 5  Interior lights [177](#)

Sensors of the vehicle

Vehicle features and options

This chapter describes all standard, country-specific and optional features offered with the series. It also describes features and functions that are not necessarily available in your vehicle, e.g., due to the selected options or country versions. This also applies to safety-related functions and systems. When using these functions and systems, the applicable laws and regulations must be observed.

Overview

Depending on the equipment, the following cameras and sensors are installed in the vehicle:

- ▶ Front camera.
- ▶ Cameras behind the windshield.
- ▶ Top view cameras.
- ▶ Rearview camera.
- ▶ Front radar sensor.
- ▶ Radar sensors, side, front.
- ▶ Radar sensors, side, rear.
- ▶ Ultrasound sensors in the front/rear bumpers.
- ▶ Ultrasonic sensors, side.

Keep the vehicle cameras and sensors, as well as surrounding areas, clean and unobstructed.

Cameras

Front camera



Front camera

Cameras behind the windshield

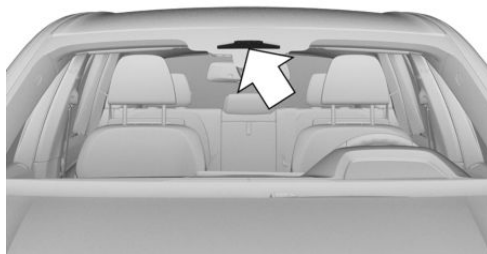

The cameras are located in the area of the interior mirror.

Top view cameras

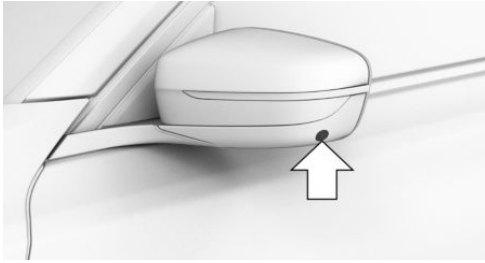

One camera is located at the bottom of each exterior mirror housing.

Rearview camera

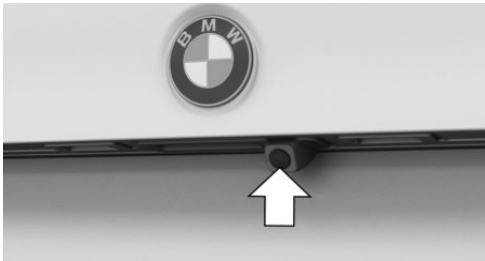

The camera is located in the handle of the trunk lid.

System limits of the cameras

The cameras may not be fully functional and may provide incorrect information in the following situations:

- ▷ In heavy fog, wet conditions, or snowfall.
- ▷ On steep hills, in steep depressions or in tight curves.
- ▷ When the camera field of view is covered, for instance by a fogged up windshield or labels.
- ▷ If the camera lens is dirty or damaged.
- ▷ With exterior mirrors folded in.
- ▷ When driving toward bright lights or strong reflections, e.g., because of a setting sun.
- ▷ When it is dark outside.

- ▷ Camera behind the windshield: if the camera has overheated and been temporarily switched off due to excessively high temperatures.
- ▷ Camera behind the windshield: during calibration of the camera immediately after vehicle delivery.

If applicable, a Check Control message will be displayed when the system limits are reached.

Radar sensors

Front radar sensor

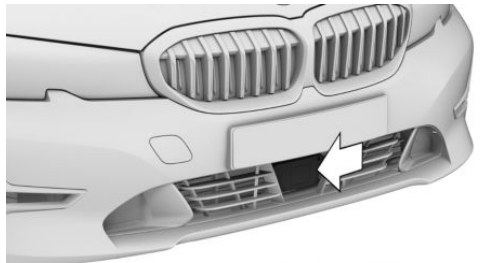

The radar sensor is located in the front bumper.

Radar sensors, side, front



The radar sensors are located in the bumper.

Radar sensors, side, rear



The radar sensors are located in the bumper.

System limits of the radar sensors

The radar sensors may not be fully functional or may not be available in the following situations:

- ▶ If sensors are dirty, such as due to icing.
- ▶ If sensors are covered, such as by labels, films or a number plate baseplate.
- ▶ If the sensor is not aligned correctly, for instance due to parking damage.
- ▶ If the radiation range of the sensors is covered, e.g., by protruding cargo.
- ▶ When the field of view of the sensors is covered, e.g., by garage walls, hedges, snow hills, vehicles or trailers.
- ▶ After improper paint work on the vehicle in the area of the sensors.
- ▶ On steep hilltops or in sharp dips in the road.

If applicable, a Check Control message will be displayed when the system limits are reached.

Ultrasound sensors

Ultrasound sensors in the front/rear bumpers



The ultrasound sensors of the Park Distance Control PDC are located in the bumpers.

Ultrasonic sensors, side

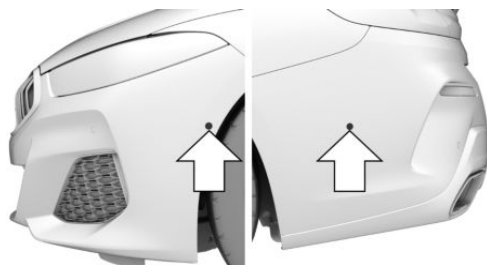

The ultrasound sensors of the Automatic Parking Assistant are located on the side of the vehicle.

System limits of the ultrasonic sensors

The detection of objects with ultrasonic measurements can run into physical limits, e.g., in the following situations:

- ▶ In case of dirty sensors.
- ▶ In case of covered sensors, such as due to labels.
- ▶ If the sensor is not aligned correctly, for instance due to parking damage.
- ▶ After improper paint work on the vehicle in the area of the sensors.
- ▶ For small children and animals.
- ▶ For persons with certain clothing, for instance jacket.
- ▶ In case of external interference of the ultrasound, for instance from passing vehicles, loud machines or other ultrasonic sources.

- ▷ Under certain weather conditions, e.g., high relative atmospheric humidity, wet conditions, snowfall, cold, extreme heat, or strong wind.
- ▷ With tow bars and trailer couplings of other vehicles.
- ▷ With thin or wedge-shaped objects.
- ▷ With moving objects.
- ▷ With elevated, protruding objects such as ledges.
- ▷ With objects with corners, edges, and smooth surfaces.
- ▷ With objects with a fine surface structure such as fences.
- ▷ For objects with porous surfaces.
- ▷ With small and low objects, for instance boxes.
- ▷ With soft obstacles or obstacles covered in foam material.
- ▷ With plants and bushes.
- ▷ In automatic car washes.
- ▷ On uneven surfaces, such as speed bumps.
- ▷ Due to heavy exhaust.
- ▷ Cargo that extends beyond the perimeter of the vehicle is not taken into account by the ultrasonic sensors.

If applicable, a Check Control message will be displayed when the system limits are reached.

Operating state of the vehicle

Vehicle features and options

This chapter describes all standard, country-specific and optional features offered with the series. It also describes features and functions that are not necessarily available in your vehicle, e.g., due to the selected options or country versions. This also applies to safety-related functions and systems. When using these functions and systems, the applicable laws and regulations must be observed.

General information

Depending on the situation, the vehicle is in one of the three states:

- ▷ Idle state.
- ▷ Standby state.
- ▷ Drive-ready state.

Idle state

Principle

When the vehicle is in idle state, it is switched off.

General information

The vehicle is in idle state prior to opening from the outside and after exiting and locking.

Safety information

Warning

An unsecured vehicle can begin to move and possibly roll away. There is a risk of accident. Before exiting, secure the vehicle against rolling.

In order to ensure that the vehicle is secured against rolling away, follow the following:

- ▷ Set the parking brake.
- ▷ On uphill grades or on a downhill slope, turn the front wheels in the direction of the curb.
- ▷ On uphill grades or on a downhill slope, also secure the vehicle, for instance with a wheel chock.

Warning

Unattended children or animals in the vehicle can cause the vehicle to move and endanger themselves and traffic, for instance due to the following actions:

- ▷ Pressing the Start/Stop button.
- ▷ Releasing the parking brake.
- ▷ Opening and closing the doors or windows.
- ▷ Engaging selector lever position N.
- ▷ Using vehicle equipment.

There is a risk of accidents or injuries. Do not leave children or animals unattended in the vehicle. Take the vehicle key with you when exiting and lock the vehicle.

Automatic idle state

For instance, the idle state is automatically established under the following conditions:

- ▶ After several minutes, if no operation takes place on the vehicle.
- ▶ If the charge state of the vehicle battery is low.
- ▶ Depending on the setting via iDrive: when one or both front doors are opened after driving when exiting the vehicle.

In some situations, the idle state is not set automatically, for instance during a phone call or when the low beams are switched on.

Establishing idle state when opening the front doors

After a trip, the sleep mode can be established by opening the front doors. For this purpose, the driver and front passenger must exit the vehicle.

1. "CAR"
2. "Settings"
3. "Doors/ vehicle access"
4. "Turn off vehicle after opening door"

Manual idle state

To establish idle state in the vehicle after completion of trip:



Press and hold the button on the radio until the OFF indicator on the instrument cluster goes out.

Standby state

Principle

When standby state is switched on, most functions can be used while the vehicle is stationary. Desired settings can be adjusted.

General information

The vehicle is in the standby state after the front doors are opened from the outside.

Display in the instrument cluster



OFF is displayed in the instrument cluster. The drivetrain is switched off and standby state switched on.

Drive readiness

Principle

Turning on drive-ready state corresponds to starting the engine.

General information

Some functions, such as DSC Dynamic Stability Control, can only be used with drive-ready state switched on.

Safety information

DANGER

If the exhaust pipe is blocked or ventilation is insufficient, harmful exhaust gases can enter into the vehicle. The exhaust gases contain pollutants which are colorless and odorless. In enclosed areas, exhaust gases can also accumulate outside of the vehicle. There is danger to life. Keep the exhaust pipe free and ensure sufficient ventilation.

Warning

An unsecured vehicle can begin to move and possibly roll away. There is a risk of accident. Before exiting, secure the vehicle against rolling.

In order to ensure that the vehicle is secured against rolling away, follow the following:

- ▷ Set the parking brake.
- ▷ On uphill grades or on a downhill slope, turn the front wheels in the direction of the curb.
- ▷ On uphill grades or on a downhill slope, also secure the vehicle, for instance with a wheel chock.

NOTICE

Repeated attempts to start the vehicle or repeated starting of the vehicle in rapid succession can cause the starter to overheat. This also results in unburned or inadequately burned fuel, and can cause the catalytic converter to overheat. There is a risk of damage to property, among other potential damage. Avoid repeated starting of the vehicle, particularly repeated starting in rapid succession.

Additional information:

Instrument cluster with enhanced features:

Power gauge, refer to page 160.

Display in the instrument cluster

The activated drive readiness is indicated in the instrument cluster, depending on the equipment, by the display of information required for driving or the READY display.

Turning off drive-ready state

Steptronic transmission

1. Engage selector lever position P with the vehicle stopped.
2. Press the Start/Stop button.
The engine is switched off. The vehicle switches into standby state.
3. Set the parking brake.

Turning on drive readiness

Principle



Drive-ready state is switched on via the Start/Stop button.

Steptronic transmission

1. Depress the brake pedal.
2. Press the Start/Stop button.

The ignition is activated automatically for a brief time and is stopped as soon as the engine starts.

Most of the indicator/warning lights in the instrument cluster light up for a varied length of time.

Gasoline engine

Depending on the motorization, the full drive power may not be available for approximately 30 seconds after starting the engine. In this case, the vehicle will not accelerate as usual.

iDrive

Vehicle features and options

This chapter describes all standard, country-specific and optional features offered with the series. It also describes features and functions that are not necessarily available in your vehicle, e.g., due to the selected options or country versions. This also applies to safety-related functions and systems. When using these functions and systems, the applicable laws and regulations must be observed.

Operating concept

Principle

iDrive is the operating concept of the infotainment system and includes a large number of functions.

General information

These functions can be operated as follows:

- ▶ Via the Controller.
- ▶ Via the touchscreen.
- ▶ Via the BMW Intelligent Personal Assistant.
- ▶ Depending on the equipment: with the gesture control.

Safety information

Warning

Operating the integrated information systems and communication devices while driving can distract from traffic. It is possible to lose control of the vehicle. There is a risk of accident. Only use the systems or devices when the traffic situation allows. As warranted, stop and use the

systems and devices while the vehicle is stationary.

Input and display

Main menu

General information

The main menu is divided into two areas. The left area contains menu items that can be used to call up all the iDrive functions. The right area contains widgets that provide quick access to certain functions.

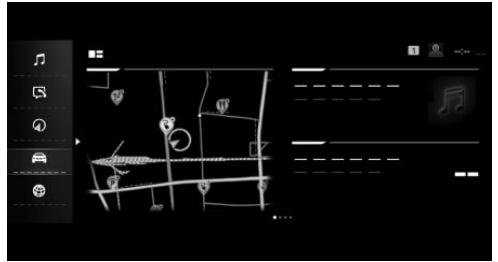

Media/Radio

 All functions of the entertainment system, e.g., radio stations or connection with external devices.

Communication

 Phone and message functions, e-mail and calendar, and also the connection and management of mobile devices, such as smartphones.

Navigation

 Access to the navigation system, destination input and traffic bulletins. Configurable map views and other functions, such as points of interest and areas to be avoided.

My Car

 Information about vehicle status and trips. Access to the Integrated Owner's Manual and also administration of driver profiles and range of adjustments for vehicle and iDrive.

Apps

 Management of apps, access to apps and vehicle functions. Additional apps and vehicle functions can be purchased from the BMW Store.







Widgets

 Widgets provide quick access to frequently used functions. The configured widgets display dynamic contents such as the navigation map, and serve as interfaces at the same time.

Letters and numbers

Letters and numbers can be selected when making the destination input, for example.

Letters and numbers can be entered using the Controller, the touchpad, touchscreen or voice control. The keyboard's display changes automatically.

| Icon | Function |
|--|--|
|  | Change between capital and lower-case letters. |
|  | Enter a blank space. |
|  | Switching between languages. |
|  | Use voice control. |
|  | Confirm entry. |
|  | Slide the input area to the left or right. |

Entry comparison

When entering names and addresses, the choice is narrowed down with every letter and number and added automatically as needed.

Entries are continuously compared with data stored in the vehicle.

- ▶ Only those letters and numbers are offered during entry for which data is available.
- ▶ Destination search: place names can be entered in all languages that are available in iDrive.

Activating/deactivating the functions

Several menu items are preceded by a checkbox. The checkbox indicates whether the function is activated or deactivated. Selecting the menu item activates or deactivates the function.



- Function is activated.
- Function is deactivated.

Status information







General information

The status field can be found in the upper area of the Control Display. Status information is displayed in the form of symbols.

Radio symbols

| Icon | Meaning |
|---|-------------------------------------|
|  | HD Radio station is being received. |
|  | Satellite radio is switched on. |

Telephone symbols

| Icon | Meaning |
|---|---|
|  | Incoming or outgoing call. |
|  | Missed call. |
|  | Signal strength of mobile phone network. |
|  | Network search. |
|  | Mobile phone network is not available. |
|  | The critical charge state of the mobile phone has been reached. |

| Icon | Meaning |
|------|----------------------------|
| | Roaming is active. |
| | Locating is active. |
| | SMS text message received. |
| | Message received. |
| | Reminder. |
| | Sending not possible. |

Entertainment symbols

| Icon | Meaning |
|------|------------------|
| | Bluetooth audio. |
| | USB device. |
| | Connected Music. |
| | WLAN. |
| | Apple CarPlay. |
| | Android Auto. |

Other symbols

| Icon | Meaning |
|------|---|
| | Check Control message. |
| | Sound output active. |
| | Sound output deactivated. |
| | Voice activation system active. |
| | Request for the current vehicle position. |
| | Checking the current vehicle position. |
| | Driver profile. |
| | Notifications. |
| | Service notifications. |
| | Information. |

| Icon | Meaning |
|------|------------------------------|
| | Stop. |
| | Data protection. |
| | Destination guidance active. |
| | Passengers on board. |
| | Do not disturb. |

Programmable memory buttons

General information

The iDrive functions can be stored on the programmable memory buttons and called up directly, for instance radio stations, navigation destinations, phone numbers and menu entries.

Overview



1...8 Programmable memory buttons

Storing a function

A function can be stored on a programmable memory button. A button with a stored function can be overwritten with another function.

1. Select function via iDrive, for instance radio station.
2. **1...8** Press and hold the desired button until the displayed bar on the Control Display has loaded completely.

Executing a function

1... 8 Press the button.

The function will work immediately. This means, for instance that the number is dialed when a phone number is selected.

Displaying the key assignment

Touch buttons with finger. Do not wear gloves or use objects.

The assignment of the buttons is displayed in the upper area of the Control Display.

Deleting all button assignments

All button assignments can be deleted.

1. Press and hold buttons 1 and 8 at the same time.
2. "OK"

Control Display and Controller

Principle

The iDrive functions are displayed on the Control Display. The Control Display can be operated using the Controller, touchpad, and touchscreen.

Overview

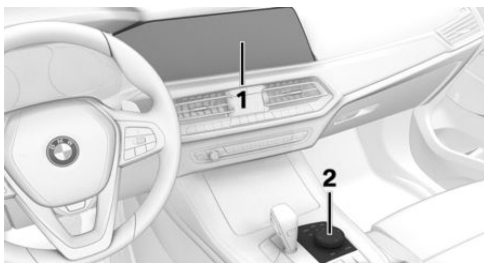

- 1 Control Display with touchscreen
- 2 Controller with buttons and touchpad

Control Display

Safety information

! NOTICE

Objects in the area in the front of the Control Display can shift and damage the Control Display. There is a risk of damage to property, among other potential damage. Do not place objects in the area in front of the Control Display.

Switching on/off automatically

The Control Display is turned on automatically when the vehicle is unlocked or as soon as the control display is needed for operation.

In certain situations, the Control Display is switched off automatically, for instance if no operation is performed on the vehicle for several minutes.

Switching on/off manually

The Control Display can also be switched off manually.

1. Tip the Controller up.
2. "Screen off"

Press the Controller or any button on the Controller to switch it back on again.

System limits

In the case of very high temperatures on the Control Display, for instance due to intense solar radiation, the brightness may be reduced down to complete deactivation. Once the temperature is reduced, for instance through shade or air conditioning, the normal functions are restored.

Controller

General information

The buttons can be used to open the menus directly. The Controller can be used to select menu items and enter the settings.

Some iDrive functions can be operated using the touchpad on the Controller.

Operation

- ▶ Turn to switch between menu items, for example.

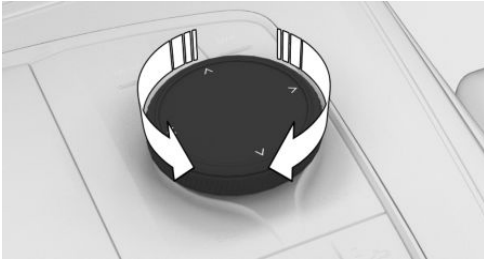

- ▶ Press to select a menu item, for example.

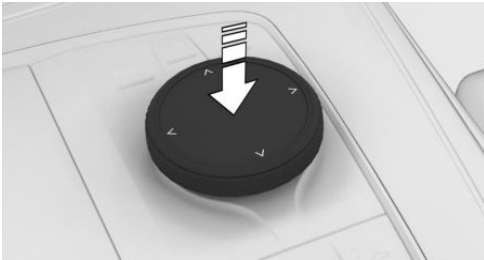

- ▶ Tilt in four directions to switch between displays, for example.

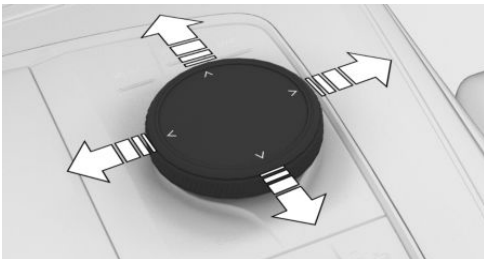

Buttons on the Controller

| Button | Function |
|---|--|
|  | Go to the main menu. |
|  | Go to Apps menu. |
|  | Go to the Media/Radio menu. |
|  | Go to the Communication menu. |
|  | Go to navigation map. |
|  | Go to destination input menu for navigation. |
|  | Go to the previous display. |
|  | Go to the Options menu. |

Operating via the Controller

Opening the main menu

-  Press the button.

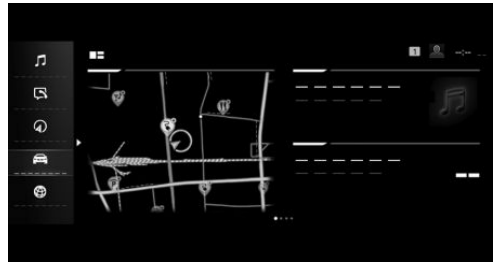

The main menu is displayed.

Selecting a menu

Selecting menu items

1. Turn the Controller until the desired menu item is highlighted.
2. Press the Controller.

Select a widget

1. Move the Controller in the main menu to the right.
2. Turn the Controller until the desired widget is selected.
3. Press the Controller.

It is also possible to select widgets in the instrument cluster.

Adjusting the menu

Adjusting widgets

The widgets can be adjusted in the main menu. It is possible to create multiple pages with widgets and switch between pages. The adjustments can only be performed when the vehicle is stationary.

1. Select the desired page in the main menu. Only the currently selected page can be adjusted.
2. Tip the Controller up.
3. "Adjust main menu"
4. Select the desired adjustment:
 - ▷ **+** Symbol and select desired widget: add new widget.
The requested widget will be inserted in the relevant position. A maximum of four widgets can be displayed per page.
 - ▷ **X** Select icon: delete selected widget.
 - ▷ Add new page: "Add page".
 - ▷ Delete selected page: "Delete page".
 - ▷ Adjust the content of the widget: select widget.
5. "Done"

Adjusting contents

Depending on the equipment, the contents of menus "MEDIA", "COM" and "NAV" can be adjusted, for instance to remove the entries of functions that are not used from the menu.

1. Select the menu.
2. "Personalize menu"
3. Select the desired setting.

Changing between displays

After a menu item is selected, for instance "Settings", a new display appears.

- ▷ Tilt the Controller to the left.

The current display closes and the previous display is shown.

- ▷  Press the button.

The previous display re-opens.

- ▷ Tilt the Controller to the right.
The new display opens.

An arrow indicates that additional displays can be opened.

Going to the Options menu

- ▷  Press the button.

The "Options" menu is displayed.

The menu consists of various areas, for instance:



- ▷ "MEDIA": control options for the selected main menu.
- ▷ "Help": help for the selected menu.
- ▷ "Control display off": system settings.

Entering letters and numbers

Input

1. Turn the Controller: select letter or number.
2. **OK** : confirm entry.

Deleting

| Icon | Function |
|---|--|
|  | Press the Controller: delete letter or number. |
|  | Hold the Controller down: delete all letters or numbers. |

Using alphabetical lists

For alphabetical lists with more than 30 entries, the letters for which an entry exists can be displayed in a text box.

1. Turn the Controller to the left or right quickly.
2. Select the first letter of the desired entry.
The first entry of the selected letter is displayed in the list.

Operation via touchpad

General information

Some iDrive functions can be operated using the touchpad on the Controller.

Selecting functions

1. "CAR"
2. "Settings"
3. "General settings"
4. "Touchpad"
5. Select the desired setting.

Entering letters and numbers

- ▷ Enter characters as they are displayed on the Control Display.
- ▷ Always enter associated characters, such as accents or periods so that the letter can be clearly recognized.
- ▷ The set language determines what input is possible. Where necessary, enter special characters via the Controller.

Entering special characters

| Input | Operation |
|----------------------|---|
| Delete a character. | Swipe to the left on the touchpad. |
| Enter a blank space. | Swipe to the right in the center of the touchpad. |
| Enter a hyphen. | Swipe to the right in the upper area of the touchpad. |
| Enter an underscore. | Swipe to the right in the lower area of the touchpad. |

Using the map

The map in the navigation system can be moved via the touchpad.

| Function | Operation |
|---------------------|--|
| Move map. | Swipe in the appropriate direction. |
| Enlarge/shrink map. | Drag in or out on the touchpad with fingers. |
| Display menu. | Tap once. |

Using alphabetical lists

Alphabetical lists with more than 30 entries permit a direct jump to letters for which an entry exists.

Enter the first letter on the touchpad.

The first entry of the entered letter is displayed in the list.

Operation via touchscreen

General information

The Control Display is equipped with a touchscreen.

You can tap on menu items and widgets. Touch the touchscreen with your fingers. Do not use any objects.

Opening the main menu

Tap on the icon.

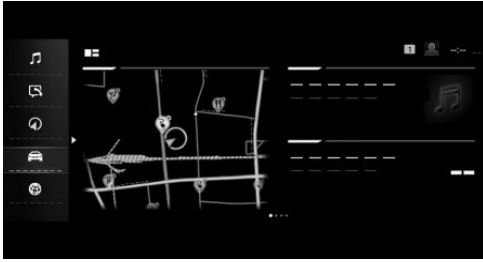

The main menu is displayed.

Adjusting widgets

The widgets can be adjusted in the main menu. It is possible to create multiple pages with widgets and switch between pages. The adjustments can only be performed when the vehicle is stationary.

1. Select the desired page in the main menu. Only the currently selected page can be adjusted.
2. Tap the icon in the main menu.
3. Select the desired adjustment:
 - ▶ **+** Tap icon and select desired widget: add new widget.
The requested widget will be inserted in the relevant position. A maximum of four widgets can be displayed per page.
 - ▶ **X** Tap icon: delete selected widget.
 - ▶ Add new page: tap "Add page".
 - ▶ Delete selected page: tap "Delete page".
 - ▶ Adjust content of the widget: tap center of widget.
4. Tap "Done".

Showing/hiding the display bar

In the upper area of the Control Display, it is possible to show or hide a display bar with additional functions.

- ▶ To show the display bar, pull down the display bar at the top edge of the screen.
- ▶ To hide the display bar, pull up the display bar at the top edge of the screen.

Changing between displays

After a menu item is selected, a new display opens.

An arrow indicates that additional displays can be opened.

- ▶ Swipe to the left.
- ▶ Tap arrow.

The new display opens.

Entering letters and numbers

Input

1. Depending on the equipment version, tap the  icon on the touchscreen or a keyboard is displayed on the Control Display when the touchscreen is approached.
2. Enter desired letters and numbers.

Deleting

| Icon | Function |
|---|---|
|  | Tapping the icon: deletes the letter or number. |
|  | Tapping and holding the icon all letters: deletes all letters or numbers. |

Using the map

The navigation map can be moved using the touchscreen.

| Function | Operation |
|---------------------|-------------------------------------|
| Move map. | Swipe in the appropriate direction. |
| Enlarge/shrink map. | Drag in or out with the fingers. |
| Display menu. | Tap once. |

Using alphabetical lists

For alphabetical lists with more than 30 entries, the letters for which an entry exists can be displayed in a text box.

1. Tap the letter in front of the list.
A letter box is displayed.
2. Tap the first letter of the desired entry.

BMW Intelligent Personal Assistant

Principle

The BMW Intelligent Personal Assistant is a personal assistant that enables natural voice operation of various vehicle functions. The Personal Assistant simplifies the operation of the vehicle with the automation of processes and habits.

General information

- ▶ BMW Intelligent Personal Assistant is available depending on the national-market version.
- ▶ The system includes special microphones on the driver side and the front passenger side.
- ▶ Say commands at a normal volume. Speaking directly into the microphone does not improve the speech recognition.
- ▶ Say the commands and numbers fluently as well as with normal volume, emphasis, and speed.
- ▶ ›...‹ identifies commands that can be spoken.

Functional requirements

- ▶ A language that is supported by the Personal Assistant must be set via iDrive.

Setting the system language, refer to page 64.

- ▶ Always say commands in the configured system language.

Enter the following settings to access the full range of functions:

- ▶ "Online speech processing" is activated.
- ▶ All settings under "BMW ConnectedDrive" activated.
- ▶ Activation word is activated.
- ▶ The Driver profile is activated.
- ▶ "Synchronize driver profile" under "Personalization" is activated.
- ▶ Relevant ConnectedDrive Services purchased from the ConnectedDrive Store.

Activating the voice control system

General information

There are various methods for activating the voice control feature:

- ▶  Press the button on the steering wheel.
The microphone on the driver's side is active.
- ▶ Say the wake word ›Hello BMW‹ or a personal wake word.
The microphones on the driver's or front passenger's side are active with the following voice control, depending on where the activation word was spoken.

Then say the command. The activation word and the command can be spoken without pause in one sentence. No other commands may be available. In this case, operate the function via iDrive.

Button on the steering wheel

1.  Press the button on the steering wheel briefly.
2. Say the command.

Wake word

General information

Speaking the wake word ›Hello BMW‹ or the personal wake word will start the system.

Preset wake word

The preset wake word ›Hello BMW‹ can be activated and deactivated.

1. "CAR"
2. "Settings"
3. "General settings"
4. If necessary, "Personal assistant"
5. "Voice control"
6. "Wake word"
7. "Wake word"

Personal wake word

In addition to a preset activation word ›Hello BMW‹, a personal activation word can be set up in the active driver profile. The personal activation word can also be changed or deleted.

The activation word should consist of multiple syllables to ensure good recognition. An addition, such as ›Hello‹ is not necessary.

1. "CAR"
2. "Settings"
3. "General settings"
4. If necessary, "Personal assistant"
5. "Voice control"
6. "Wake word"
7. "Personal wake word"
8. "Set wake word"
9. Select the desired setting.

Activation word from third-party providers

Depending on the national-market version, some third-party providers provide digital voice assistants, e.g., Siri, Amazon Alexa or Google Assistant.

Supported voice assistants can be used with a connected smartphone in the vehicle. In addition to the preset or personal activation word, the activation word from connected third-party providers can be used.

1. "CAR"
2. "Settings"
3. "General settings"
4. If necessary, "Personal assistant"
5. "Voice control"
6. "Third-party providers"
7. Select the desired setting.

Ending voice control

- ▷  Press the button on the steering wheel again.
- ▷ ›Cancel‹
- ▷ Tilt the Controller to the right or left.
- ▷ Press the Controller.

Possible commands

General information

Most contents on the Control Display can be spoken as commands, e.g. menu items or list entries. Say list entries as shown.

Instructions can be issued or questions can be asked where the Personal Assistant provides support.

Function examples

Vehicle status and vehicle information

- ▷ ›Is my tire pressure still OK?‹
- ▷ ›Show me the sport displays.‹
- ▷ ›Open Owner's Manual.‹

Navigation

- ▷ ›Drive me to 300 Chestnut Ridge Road, Woodcliff Lake in New Jersey.‹
- ▷ ›Take me home.‹
- ▷ ›Are there any traffic messages?‹

Communication

For example, when a mobile phone is connected, calls can be started or SMS can be sent.

- ▷ ›Call John Doe on cell phone.‹
- ▷ ›Dial the number 1 8 0 0 8 3 1 1 1 1 7.‹
- ▷ ›New text message to John Doe: I'll be right there.‹

Entertainment

- ▷ ›What song is this?‹
- ▷ ›Play Blue Suede Shoes by Elvis Presley.‹
- ▷ ›Next title.‹

Climate control

- ▷ ›Turn off the air conditioning.‹
- ▷ ›Activate fresh air.‹
- ▷ ›I'm cold.‹

Windows and light

- ▷ ›Open the windows automatically.‹
- ▷ ›Delete activation point for automatic power window.‹
- ▷ ›Ambient lighting.‹

Owner's Manual via voice operation

You can ask simple questions about vehicle functions and the operation of the vehicle.

The voice control system and the feedback it provides does not replace the printed or Integrated Owner's Manual. The speech recognition and quality of the feedback may vary.

›How can the passenger airbag be deactivated‹
The Personal Assistant returns feedback. When stationary, the section of the integrated Owner's Manual is displayed on the Control Display.

Menu items

The commands of the menu items are spoken just as they are selected via the Controller.

1. Activating the voice control system.
2. ›MEDIA‹
3. ›Presets‹

The stored stations are displayed on the Control Display.

Help for voice control

- ▷ ›Voice commands‹: to have the available spoken commands announced.
- ▷ ›General information on voice control‹: have information on the operating principle of the voice control announced.
- ▷ ›Help‹: have help for the current menu read out loud.

Settings

Setting the voice control

You can set the system to use standard dialog or a short version.

The short version of the voice control plays back short messages in abbreviated form.

1. "CAR"
2. "Settings"
3. "General settings"
4. If necessary, "Personal assistant"
5. "Voice control"

6. "Response length"
7. Select the desired setting.

Speaking during voice output

It is possible to answer during inquiries of the voice activation system. The function can be deactivated if inquiries are often undesirably interrupted, for instance due to background noise or conversations in the vehicle.

1. "CAR"
2. "Settings"
3. "General settings"
4. If necessary, "Personal assistant"
5. "Voice control"
6. "Speaking during voice output"

Online speech processing

Online voice processing improves the quality of the speech recognition and search results for points of interest. To use the functions, data is transmitted to a service provider via an encrypted connection and stored locally there.

1. "CAR"
2. "Settings"
3. "General settings"
4. If necessary, "Personal assistant"
5. "Voice control"
6. "Online speech processing"

Adjusting the volume



Turn the volume button during the voice guidance until the desired volume is set.

The volume remains constant even if the volume of other audio sources is changed.

Using the voice activation of the smartphone

Depending on the device, a smartphone connected to the vehicle can be used via voice control.

The device must be connected via Apple CarPlay or Android Auto.

1.  Press and hold the button on the steering wheel for approx. 3 seconds.
The voice activation of the smartphone is activated.
2.  Release the button.
If activation is successful, a confirmation appears on the Control Display.

Automating routines

General information

The Personal Assistant can automate routines, for instance the automatic activation of the seat heating from a specific outside temperature. Rules are created for this purpose, which can be activated and deactivated at any time.

Activate/deactivate

1. "APPS"
2. "Installed apps"
3. "Personal assistant"
4. "Automate habits"
5. Select the desired setting.

Caring Car

Principle

Different vehicle functions in the car's interior are harmonized for the driver in a short-term program.

General information

By selecting a program, the interior lighting, climate control and music selection will be adjusted. A program takes 3 minutes.

Activate/deactivate

1. "CAR"
2. "Caring Car"
3. Select the desired program.

The program can be stopped prematurely:

"End program"

Adjusting a program

1. "CAR"
2. "Caring Car"
3. Select the desired program.
4. "Music settings"
5. Select the desired setting.

System limits

- ▷ The Personal Assistant provides information about vehicle functions that may not be installed in the vehicle.
This also applies to safety-related functions and systems.
- ▷ Certain noises can be detected and may lead to problems. Keep the doors, windows, and glass sunroof closed.
- ▷ Noises from the front passenger or the occupants can impair the system. Avoid making other noise in the vehicle while speaking.
- ▷ Major language dialects can cause problems with the speech recognition feature.
- ▷ A poor data connection influences the response time of the Personal Assistant and the Search.

BMW Gesture Control

Principle

Several iDrive functions can be operated by hand motion using BMW Gesture Control.

Overview

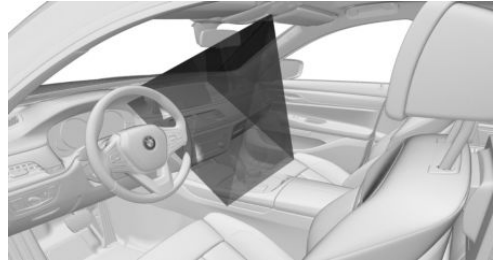

The camera in the headliner detects gestures that are carried out in the area of the center console at the height of the Control Display.

Activate/deactivate

1. "CAR"
2. "Settings"
3. "General settings"
4. "Gesture control"
5. "Gesture control"





Settings

1. "CAR"
2. "Settings"
3. "General settings"
4. "Gesture control"
5. Select the desired setting.

Carrying out gestures

- ▷ Perform gestures underneath the interior mirror and next to the steering wheel.
- ▷ Execute gestures clearly.
- ▷ The gestures can also be executed from the front-passenger side.

Possible gestures

| Gesture | Operation | Function |
|--|---|--|
|  | Move index finger forward and backward in the direction of the screen. | Accept call. Select a highlighted entry in a list during voice control. Confirm pop-up. |
|  | Move hand across the width of the Control Display in the direction of the front-passenger side. | Reject call. Close pop-up. End voice control. |
|  | Slowly move hand clockwise in a circular pattern with the index finger stretched out forward. Gesture is detected after one circular motion. | Increase the volume. |
|  | Slowly move forearm counterclockwise in a circular pattern with the index finger stretched out forward. Gesture is detected after one circular motion. | Reduce the volume. |
|  | Pinch with thumb and index finger and move hand horizontally to the right or left. | Surround View: turn camera view. This gesture can only be executed while the vehicle is stationary. |
|  | Move stretched out index and middle finger forward. | Individually assignable gesture. |
|  | Move fist with thumb extended to the left back and forth. | Reverse Skip function. The previous title is played. |

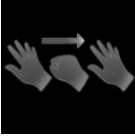
| Gesture | Operation | Function |
|--|---|---|
|  | Move fist with thumb extended to right left back and forth. | Forward Skip function. The next title is played. |
|  | Stretch out five fingers, form a fist and stretch five fingers out again. | Individually assignable gesture. |

Assigning gesture individually

General information

Two gestures can be assigned individually and can be configured for certain functions, such as:

- ▷ Destination guidance to home address.
- ▷ Mute/Playback
- ▷ Control Display on/off

Select function

1. "CAR"
2. "Settings"
3. "General settings"
4. "Gesture control"
5. "Function assignment gesture 1" or "Function assignment gesture 2"
6. Select the desired setting.

System limits

Gesture recognition by the camera in the headliner can be disturbed by the following circumstances:

- ▷ The camera lens is covered.
- ▷ Objects are located on the interior mirror.
- ▷ The camera lens is dirty, clean camera lens.

Sensors and camera lenses, refer to page 374.

BMW Remote Software Upgrade

Vehicle features and options

This chapter describes all standard, country-specific and optional features offered with the series. It also describes features and functions that are not necessarily available in your vehicle, e.g., due to the selected options or country versions. This also applies to safety-related functions and systems. When using these functions and systems, the applicable laws and regulations must be observed.

BMW Remote Software Upgrade

Principle

Remote Software Upgrade can be used to update the entire software of the vehicle. This makes new functions, functional enhancements or quality improvements available.

General information

BMW recommends performing the Remote Software Upgrade as soon as it becomes available.

Safety information

Warning

Unattended children or animals in the vehicle can cause the vehicle to move and endanger themselves and traffic, for instance due to the following actions:

- ▷ Pressing the Start/Stop button.
- ▷ Releasing the parking brake.

- ▷ Opening and closing the doors or windows.
- ▷ Engaging selector lever position N.
- ▷ Using vehicle equipment.

There is a risk of accidents or injuries. Do not leave children or animals unattended in the vehicle. Take the vehicle key with you when exiting and lock the vehicle.

Functional requirement

- ▷ Active ConnectedDrive contract.
- ▷ The integrated SIM card in the vehicle has been activated.
- ▷ Cellular network reception.
- ▷ A consent for the transmission of the corresponding data was given in the Data Protection menu.

Search for an upgrade

Standby must be turned on to search for a software upgrade.

Automatic search

The vehicle regularly searches for updates in the background.

Manual search

1. "CAR"
2. "Settings"
3. "General settings"
4. "Remote Software Upgrade"
5. "Search for upgrades"
6. Follow the instructions on the Control Display.

Download of an upgrade

Automatic download

The available data for Remote Software Upgrade is automatically loaded into the vehicle. The download does not require an approval.

Via BMW app

If an upgrade is available, information about the new software version is displayed in the BMW app.

The data for the upgrade can then be downloaded to a mobile device, for instance via an existing WLAN connection.

The data can then be transmitted from the mobile device to the vehicle.

This transmission method accelerates the download of the data, for instance in areas with limited mobile network availability.

1. Download the upgrade in the BMW app to the smartphone.
2. Follow the instructions in the BMW app.
3. Establish connection to the vehicle.
 - ▷ iOS: connect Bluetooth audio and WLAN.
 - ▷ Android: connect WLAN.

The data transfer of the upgrade from the mobile device to the vehicle occurs in the background only while driving.

4. Follow the instructions on the Control Display.

Additional information:

Connecting mobile devices to the vehicle, refer to page 73.

Information about the version

General information

The information about the version contains a description of the updates that are included in the Remote Software Upgrade. During the download and after the installation has been completed

successfully, the information about the version can be displayed on the Control Display.

This information is also available in the ConnectedDrive customer portal.

Displaying information

Display in the vehicle:

1. "CAR"
2. "Settings"
3. "General settings"
4. "Remote Software Upgrade"
5. "Info about version"

Display in the ConnectedDrive customer portal: www.bmw-connecteddrive.com.

Installing the upgrade

General information

- ▷ The installation of the upgrade may result in a deletion of software changes such as performance increases that have not been installed by the manufacturer of the vehicle.
- ▷ The installation may take approx. 20 minutes.
- ▷ The installation cannot be terminated.
- ▷ The vehicle cannot be used during the installation.
- ▷ The vehicle can be exited during the installation.
- ▷ The installation does not occur until the consent was given.

Prerequisites for the installation

- ▷ The battery is sufficiently charged.
- ▷ The outside temperature is above 14 °F/-10 °C.
- ▷ Vehicle is parked in a horizontal position.
- ▷ Hazard warning system is switched off.
- ▷ Selector lever position P is engaged.

- ▷ Engine is turned off and sufficiently cooled down.
- ▷ Automatic engine start for pre-conditioning is not activated via iDrive.

If applicable, follow the notes for further prerequisites on the control display.

If the prerequisites are not met, such as a sufficient vehicle battery charge state, the upgrade will not be offered for installation.

Pay attention to an offer for installation, for instance after extended driving.

Preparing the vehicle

- ▷ Park the vehicle safely away from the public road.
- ▷ Cellular network reception must be ensured so that a fault message can be sent, for instance if the installation is terminated.
- ▷ Close the windows.
- ▷ Close the glass sunroof.
- ▷ Close the trunk lid.
- ▷ Remove energy consuming devices, such as a mobile phone.
- ▷ The vehicle key must be located in the vehicle for the consent for installation.
- ▷ Switch off the exterior lighting.
- ▷ Remove connected devices from the OBD socket.

Starting installation

The upgrade can be installed when all prerequisites have been met.

1. "CAR"
2. "Settings"
3. "General settings"
4. "Remote Software Upgrade"
5. "Start upgrade now"

Follow the instructions on the Control Display.

Functional limitations

During the upgrade, the majority of functions is temporarily unavailable, for instance:

- ▷ Hazard warning system.
- ▷ Central locking system and, if necessary, Comfort Access.
- ▷ Parking lights.
- ▷ Horn.
- ▷ Alarm system.
- ▷ Emergency call.
- ▷ Power windows.
- ▷ Operation of the tailgate.
- ▷ Glass sunroof.
- ▷ Checking the fuel filler flap lock.

The driver's door can be locked and unlocked from the outside using the integrated key.

After successful upgrade

The vehicle can be used again immediately.

Booked services, such as RTTI or Remote Services, will be reactivated automatically during the next trip.

After an extended stationary period, charge the vehicle battery with an extended drive.

Malfunction

In the event of a malfunction, follow the instructions on the control display or in the BMW app.

If the malfunction cannot be remedied, contact a dealer's service center or another qualified service center or repair shop.

Validity of the Owner's Manual

Production of the vehicle

At the time of production at the plant, the printed Owner's Manual is the most current resource.

After a software update in the vehicle

After a vehicle software update, such as via Remote Software Upgrade, the Integrated Owner's Manual for the vehicle will contain the latest information.

General settings

Vehicle features and options

This chapter describes all standard, country-specific and optional features offered with the series. It also describes features and functions that are not necessarily available in your vehicle, e.g., due to the selected options or country versions. This also applies to safety-related functions and systems. When using these functions and systems, the applicable laws and regulations must be observed.

Time

Setting the time zone

1. "CAR"
2. "Settings"
3. "General settings"
4. "Date and time"
5. "Time zone:"
6. Select the desired setting.

Setting the time

1. "CAR"
2. "Settings"
3. "General settings"
4. "Date and time"
5. "Time:"
6. Turn the Controller until the desired hours are displayed.
7. Press the Controller.
8. Turn the Controller until the desired minutes are displayed.
9. "OK"

Setting the time format

1. "CAR"
2. "Settings"
3. "General settings"
4. "Date and time"
5. "Time format:"
6. Select the desired setting.

Automatic time setting

Depending on your vehicle's optional features, the time, date and, if needed, the time zone are updated automatically.

1. "CAR"
2. "Settings"
3. "General settings"
4. "Date and time"
5. "Automatic time setting"

Date

Setting the date

1. "CAR"
2. "Settings"
3. "General settings"
4. "Date and time"
5. "Date:"
6. Turn the Controller until the desired day is displayed.
7. Press the Controller.
8. Make the settings for the month and year.
9. "OK"

Setting the date format

1. "CAR"
2. "Settings"
3. "General settings"
4. "Date and time"
5. "Date format:"
6. Select the desired setting.

Language

Setting the system language

1. "CAR"
2. "Settings"
3. "General settings"
4. "Language"
5. Select the desired setting.

Setting the units of measurement

Depending on the country version, you can set the units of measurement for some values, for instance consumption, distances, and temperature.

1. "CAR"
2. "Settings"
3. "General settings"
4. "Units"
5. Select the desired menu item.
6. Select the desired setting.

Driver Attention Camera

Principle

A camera that monitors driver activity is located in the instrument cluster. The camera evaluates the head position and eye opening and uses the

data to analyze the attention of the driver. This system supports various vehicle assistance systems, e.g.:

- ▷ Fatigue alert.
- ▷ Steering and traffic jam assistant with Extended Traffic Jam Assistant.

Activating/deactivating

1. "CAR"
2. "Settings"
3. "General settings"
4. "Driver Attention Camera"
5. Select the desired setting.

System limits

The Driver Attention Camera may not be fully functional in the following situations:

- ▷ When the Driver Attention Camera is covered by the steering wheel rim.
- ▷ When the driver is wearing infrared impermeable sunglasses.

Trip data settings

Principle

The intervals in which the trip data will be reset can be configured.

Resetting trip data

1. "CAR"
2. "Settings"
3. "General settings"
4. "Reset trip data"
5. Select the desired setting.

Speed warning

Principle

The speed warning can be used to set a speed limit. A warning will be issued when this speed limit is exceeded.

General information

The warning is repeated if the vehicle speed exceeds the set speed limit again, after it has dropped below it by 3 mph/5 km/h.

Adjusting

1. "CAR"
2. "Settings"
3. "General settings"
4. "Speed warning"
5. "Warning at:"
6. Turn the Controller until the desired speed is displayed.
7. Press the Controller.

Activate/deactivate

1. "CAR"
2. "Settings"
3. "General settings"
4. "Speed warning"
5. "Speed warning"

Accept current speed as the speed warning

1. "CAR"
2. "Settings"
3. "General settings"
4. "Speed warning"
5. "Select current speed"

Activating/deactivating pop-ups

For some functions, pop-ups are displayed automatically on the Control Display. Some of these pop-ups can be activated or deactivated.

1. "CAR"
2. "Settings"
3. "General settings"
4. "Pop-ups"
5. Select the desired setting.

Control Display

Brightness

1. "CAR"
2. "Settings"
3. "Displays"
4. "Control display"
5. "Brightness at night"
6. Press the Controller.
7. Turn the Controller until the desired brightness is set.
8. Press the Controller.

Depending on the light conditions, the brightness settings may not be clearly visible.

Reset vehicle data

All individual settings can be reset to the factory settings when the drive-ready state is switched off.

1. "CAR"
2. "Settings"
3. "General settings"
4. "Reset vehicle data"
5. "Reset vehicle data"

When the stored settings in a driver profile are synchronized with the ConnectedDrive account, these settings will remain in the ConnectedDrive account.

Notifications

Principle

The menu centrally displays all notifications arriving in the vehicle in form of a list.

General information

The following notifications can be displayed:

- ▷ Traffic messages.
- ▷ Check Control messages.
- ▷ Messages on service notifications.
- ▷ Communication messages, for example e-mails, SMS text messages or reminders.
- ▷ Messages, for instance from the BMW app.
- ▷ Messages from the manufacturer of the vehicle, for instance technical information or important customer information.

The number of notifications is additionally displayed in the status field.

Go to notifications

1. Tip the Controller up.
2. "Notifications"
3. Select desired notification.

Delete notifications

All notifications, except Check Control messages or messages from the vehicle manufacturer, can be deleted from the list.

Check Control messages or messages from the vehicle manufacturer are displayed as long as they are relevant.

1. Tip the Controller up.
2. "Notifications"

3. Select desired notifications.
4.  Press the button.
5. Select the desired setting.

Settings



It is possible to set which notifications are permitted and which notifications will be displayed at the start of the trip and at the completion of the trip.

1. Tip the Controller up.
2. "Notifications"
3. Tilt the Controller to the right.
4. "Settings"
5. Select the desired setting.

Display, notifications

General information

The BMW Intelligent Personal Assistants allows the configuration of the range of messages that will be displayed. Depending on the situation, the desired condition can be activated.

| Condition | Description |
|----------------------|---|
| "Do not disturb" | Incoming calls and non-critical notifications are not displayed.  Icon is shown in the status information with the number of messages. |
| "Passenger on board" | Private contents, such as messages, will not be displayed directly.  Icon is shown in the status information with the number of messages. |

Activate/deactivate

1. Tip the Controller up.
2. "Notifications"
3. Tilt the Controller to the right.

4. "Notification display"
5. Select the desired setting.

Personal settings

Vehicle features and options

This chapter describes all standard, country-specific and optional features offered with the series. It also describes features and functions that are not necessarily available in your vehicle, e.g., due to the selected options or country versions. This also applies to safety-related functions and systems. When using these functions and systems, the applicable laws and regulations must be observed.

Data protection

Data transmission

Principle

The vehicle offers different services, whose use requires a data transfer to BMW or a service provider. The data transmission can be deactivated for some services.

General information

When the data transmission is deactivated, the respective service cannot be used.

Only make these settings while stationary.

Settings

The data transfer can be configured in different stages or individually for separate services.

1. "CAR"
2. "Settings"
3. "General settings"
4. "Data privacy"
5. Select the desired setting.

Deleting personal data in the vehicle

Principle

Depending on the usage, the vehicle stores personal data, such as stored radio stations. This personal data can be permanently deleted using iDrive.

General information

Depending on the equipment, the following data is deleted:

- ▷ Driver profile settings.
- ▷ Stored radio stations.
- ▷ Stored programmable memory buttons.
- ▷ Travel and trip computer information.
- ▷ Navigation, for instance stored destinations.
- ▷ Phone book.
- ▷ Online data, for instance Favorites, cookies.
- ▷ Office data, for instance voice memos.
- ▷ Login accounts.
- ▷ Linking vehicle and ConnectedDrive account.

Altogether, the deletion of the data can take up to 15 minutes.

Functional requirement

Data can only be deleted while stationary.

Deleting data

The personal data in the vehicle will be deleted when the vehicle is reset to the factory settings.

Additional information:

Reset vehicle data, refer to page [65](#).

Driver profiles

Principle

Driver profiles can be created to store personal vehicle settings. If the vehicle is used by multiple drivers, each driver can create his personal driver profile. When a driver profile is selected, the vehicle will automatically apply the stored settings in the driver profile.

General information

Three personal driver profiles can be created.

In addition, a guest profile is available that can be selected by any driver. The guest profile is active when a personal driver profile has not been selected.

Changes to the vehicle settings are automatically stored in the active driver profile or in the guest profile.

The vehicle can already adjust to the driver when it is unlocked. For this purpose, the recognition via a vehicle key or a digital key must be assigned to a driver profile.

ConnectedDrive countries: The settings stored in the driver's profile can be synchronized with the personal BMW ConnectedDrive account. It is thereby possible to use these settings in other BMW vehicles as well.

Functional requirements

When a driver profile is created, switched or deleted, the vehicle must move at a maximum of walking speed.

Welcome screen

After the Control Display is switched on, the Welcome screen will be displayed.

The following actions can be carried out on the Welcome screen:

- ▷ Switching the driver profile.
- ▷ Starting the set-up assistant.

This option is offered in new vehicle for a limited period of time.

As soon as the engine is started or any button is pressed, the Welcome screen will be hidden.

Setup assistant

The setup assistant is offered in new vehicles for a limited period of time on the Welcome screen to configure the most important settings for the vehicle.

"Getting started" Select to start the set-up assistant.

The set-up assistant can be started via iDrive at any time.

1. "CAR"
2. "Settings"
3. "General settings"
4. "Getting started"

The driver is guided step by step through the following functions:

- ▷ Setting the system language.
- ▷ ConnectedDrive countries:
 - If the set-up assistant was opened in the guest profile: create driver profile.
- ▷ Pairing mobile devices with the vehicle.
- ▷ If the set-up assistant was opened from an already defined driver profile: set up personal assistant.
- ▷ Depending on whether the set-up assistant was opened from an already defined driver profile or a guest profile: set up services or confirm the explanation for the transmission of vehicle related data.
- ▷ Set up other methods for use.

The selected settings are stored in the active driver's profile.

Guest profile

The guest profile can be activated by any driver. Vehicle settings that are entered when the guest profile is active will be stored in the guest profile.

In the following cases the guest profile is automatically active:

- ▷ A driver profile has not been created yet.
- ▷ No driver profile has been assigned to the vehicle key that was used to unlock the vehicle.
- ▷ No driver profile has been assigned to the digital key that was used to unlock the vehicle.

The following limitations apply:

- ▷ The guest profile cannot be renamed.
- ▷ It is not possible to assign the recognition to the guest profile.
- ▷ It is not possible to assign a PIN to the guest profile.
- ▷ ConnectedDrive countries: It is not possible to synchronize with a ConnectedDrive account.

The guest profile is selected on the Welcome screen or via iDrive:

1. "CAR"
 2. "Driver profiles"
- As an alternative for Steps 1 and 2, the profile image can be tapped in the top status bar.
3. "Guest"
 4. "OK"

Creating a driver profile

1. "CAR"
2. "Driver profiles"
3. Tilt the Controller to the right.

As an alternative for Steps 1 to 3, the profile image can be tapped in the top status bar.

4. "Add driver profile"

Non-ConnectedDrive countries: A name must be entered for the driver profile.

ConnectedDrive countries: An existing ConnectedDrive account must be assigned to a driver profile. The following options are available for this purpose:

- ▷ "Via My BMW app"

Scanning the displayed QR code will accept the access data for the ConnectedDrive account from the BMW app.

- ▷ "Log in"

The access data must be entered via iDrive.

- ▷ "New registration"

Scan the displayed QR code and follow the instructions on the smartphone.

Selecting recognition

1. "CAR"
2. "Driver profiles"
3. Tilt the Controller to the right.

As an alternative for Steps 1 to 3, the profile image can be tapped in the top status bar.

4. "Driver recognition"
5. Select the desired setting:

- ▷ "with vehicle key"

The vehicle key that is recognized in the car's interior is assigned to the driver profile. If multiple vehicle keys are detected, the unintended vehicle keys must be removed from the car's interior.

- ▷ "With Digital Key"

The digital key that is recognized in the car's interior is assigned to the driver profile. If multiple digital keys are detected, the unintended digital keys must be removed from the car's interior.

6. "Activate linkage"

As soon as the vehicle detects the vehicle key or the digital key, the corresponding driver profile will be activated. If the vehicle key or the smartphone with the digital key is not carried with you or not recognized, the driver profile can only be selected on the Welcome screen when a PIN has been set up.

Setting up a PIN

A driver profile with recognition cannot be activated without vehicle key and without digital key.

In this case, a PIN can be set up to activate the driver profile.

Countries in which ConnectedDrive is not available: If a PIN was not set up or the PIN is not known, the driver profile cannot be activated.

Countries in which ConnectedDrive is available: If a PIN was not set up or the PIN is not known, the driver's profile can be activated with the access data of the corresponding ConnectedDrive account.

1. "CAR"
2. "Driver profiles"
3. Tilt the Controller to the right.
As an alternative for Steps 1 to 3, the profile image can be tapped in the top status bar.
4. "Driver recognition"
5. "using PIN"

Changing/canceling the recognition function

When another vehicle key or another digital key is assigned to a driver profile, the current assignment must be canceled first.

1. "CAR"
2. "Driver profiles"
3. Tilt the Controller to the right.
As an alternative for Steps 1 to 3, the profile image can be tapped in the top status bar.
4. "Driver recognition"
5. Select the desired setting:
 - ▶ "with vehicle key"
 - ▶ "With Digital Key"
6. "Activate linkage"

When the vehicle and vehicle key will be handed over, such as for maintenance, carry out the following steps first:

- ▶ Setting up PIN.
- ▶ Canceling recognition using the vehicle key.
- ▶ Switching to the guest profile.

The handed over vehicle key can then no longer be used to access the personal driver profile.

Selecting a driver profile

Depending on the recognition setting, the driver profile will be selected automatically.

If the guest profile is active, the driver profile will be selected on the Welcome screen or via iDrive. A PIN may have to be entered.

1. "CAR"
2. "Driver profiles"
As an alternative for Steps 1 and 2, the profile image can be tapped in the top status bar.
3. Select driver profile.
4. "OK"

All settings stored in the selected driver profile are automatically applied.

Switching synchronization with the ConnectedDrive account on/off

The settings stored in the driver's profile are synchronized with the personal ConnectedDrive account. This means that it is possible to use the personal settings in other BMW vehicles with ConnectedDrive access as well, if this function is supported.

The synchronization with the ConnectedDrive account is enabled when a driver profile is created or via iDrive:

1. "CAR"
2. "Driver profiles"
3. Tilt the Controller to the right.
As an alternative for Steps 1 to 3, the profile image can be tapped in the top status bar.
4. "Settings"
5. "Synchronize driver profile"
6. "Synchronize driver profile"

Renaming a driver profile

Non-ConnectedDrive countries:

1. "CAR"
2. "Driver profiles"
As an alternative for Steps 1 and 2, the profile image can be tapped in the top status bar.
3. Select driver profile.
4. "Settings"
5. Enter a profile name.
6. **OK** Select the icon.

ConnectedDrive countries:

The name of the driver profile is transferred from the ConnectedDrive account. Changes for the profile name must be made in the ConnectedDrive account.

Selecting a profile picture

1. "CAR"
2. "Driver profiles"
As an alternative for Steps 1 to 3, the profile image can be tapped in the top status bar.
3. Tilt the Controller to the right.
As an alternative for Steps 1 to 3, the profile image can be tapped in the top status bar.
4. "Avatar"
5. Select the desired profile picture.

ConnectedDrive countries:

The profile image is transferred from the ConnectedDrive customer portal or the BMW app.

Deleting the driver profile

1. "CAR"
2. "Driver profiles"
As an alternative for Steps 1 to 3, the profile image can be tapped in the top status bar.
3. Tilt the Controller to the right.
As an alternative for Steps 1 to 3, the profile image can be tapped in the top status bar.
4. "Settings"
5. "Remove driver profile"
6. Select the desired driver profile.
7. "Delete now"

ConnectedDrive countries: If the driver profile was synchronized with a ConnectedDrive account, the stored data in the ConnectedDrive account will be retained.

System limits

A clear detection of the desired vehicle key may not be possible in the following cases, e.g.:

- ▶ The driver unlocks the vehicle via Comfort Access.
- ▶ The driver changes, but the vehicle is not locked and unlocked.
- ▶ When multiple vehicle keys are located in the outer area on the driver's side of the vehicle.

ConnectedDrive countries:

A driver profile can only be created and synchronized with the ConnectedDrive account when the vehicle has cellular network reception.

The use of personal settings that are stored in the ConnectedDrive account in other vehicles is subject to technical limitations. For example, settings may be stored for a system that is not available, or available in a non-compatible version, in other vehicles.

Connections

Vehicle features and options

This chapter describes all standard, country-specific and optional features offered with the series. It also describes features and functions that are

not necessarily available in your vehicle, e.g., due to the selected options or country versions. This also applies to safety-related functions and systems. When using these functions and systems, the applicable laws and regulations must be observed.







Connecting mobile devices to the vehicle



Principle

Various connection types are available for using mobile devices in the vehicle. The connection type to select depends on the mobile device and the desired function.

General information

The following overview shows possible functions and the suitable connection types for them. The scope of functions depends on the mobile device.

| Function | Connection type | Symbol in the device list |
|---|------------------|---|
| Making calls via the hands-free system. Using phone functions via iDrive or touchscreen. Other functions, e.g. Contacts or SMS. | Bluetooth. |  |
| Playing music from the smartphone or the audio player. | Bluetooth audio. |  |
| WLAN in the vehicle: Using apps in the vehicle. | WLAN. |  |
| Wi-Fi hotspot: Using the vehicle Internet access. | WLAN. |  |
| Screen Mirroring: Showing the smartphone display on the Control Display. | WLAN. |  |
| USB port: Playing music or videos from a USB device. | USB. |  |

| Function | Connection type | Symbol in the device list |
|--|---------------------|---|
| Apple CarPlay: Using apps via iDrive and via voice operation. | Bluetooth and WLAN. |  |
| Android Auto: Using apps via iDrive and via voice operation. | Bluetooth and WLAN. |  |

The following connection types require one-time pairing with the vehicle:

- ▷ Bluetooth.
- ▷ WLAN.

Paired devices are automatically recognized later on and connected to the vehicle.

Safety information

Warning

Operating the integrated information systems and communication devices while driving can distract from traffic. It is possible to lose control of the vehicle. There is a risk of accident. Only use the systems or devices when the traffic situation allows. As warranted, stop and use the systems and devices while the vehicle is stationary.

Compatible devices

General information

Information on mobile devices compatible with the vehicle can be found at www.bmwusa.com/bluetooth.

Malfunctions may occur with devices not listed or deviating software versions.

Displaying the vehicle identification number and software part number

When looking for compatible devices, you may have to state the vehicle identification number and the software part number. These numbers can be displayed in the vehicle.

1. "COM"
2. "Mobile devices"
3. Tilt the Controller to the right.
4. "Settings"
5. "Bluetooth® info"
6. "System information"

Managing mobile devices

General information

- ▷ After one-time pairing, the devices are automatically recognized and reconnected when standby state is switched on.
- ▷ After stored content on the SIM card or the mobile phone, such as contacts, has been detected, the data is transmitted to the vehicle and can be used via iDrive.
- ▷ For some devices, certain settings are necessary, for instance authorization; see the operating instructions of the device.

Displaying the device list







All devices paired with or connected to the vehicle are displayed in the device list.

A maximum of four devices can be connected to the vehicle via Bluetooth, and a maximum of ten devices can be connected to the vehicle via WLAN. A maximum of 20 devices will be detected.

1. "COM"
2. "Mobile devices"

An icon to the right of the device name indicates, for which function the device is used.

When the icon is displayed in white, this function is actively connected to the vehicle. The icon is displayed in gray when the function of the device is inactive.

| Icon | Meaning |
|--|-------------------------------------|
|  | Telephone. |
|  | Bluetooth audio. |
|  | WLAN in the vehicle, Wi-Fi hotspot. |
|  | Apps. |
|  | Screen Mirroring. |
|  | Apple CarPlay. |
|  | Android Auto. |

Configuring the device

Functions can be activated or deactivated for paired and connected devices.

The scope of functions depends on the mobile device.

Follow the information on the Control Display.

1. "COM"
2. "Mobile devices"
3. Select the desired device.
4. Select the desired setting:
 - ▶ "Connect device"

The functions that were assigned to the device before disconnecting are assigned to the device when it is reconnected. The

functions may be deactivated on a device already connected.

- ▶ "Disconnect device"
 - The device remains paired and can be connected again.
- ▶ "Delete device"
 - The device is disconnected and removed from the device list.
- ▶ "Connection mode"
 - Select a connection mode, for instance Apple CarPlay.
- ▶ "Telephone"
 - Set telephone.
- ▶ "Bluetooth® audio"
 - Playback of music files on external devices such as audio devices or mobile phones via Bluetooth®.
- ▶ "Apps"
 - With the installed BMW app, apps from the smartphone can be displayed in the vehicle.
- ▶ "Wi-Fi®"
 - Connects the device with the WLAN in the vehicle.

Priority of the phones

When multiple mobile phones are connected to the vehicle, you can specify the priority of the mobile phones for reconnection.

1. "COM"
2. "Mobile devices"
3. Tilt the Controller to the right.
4. "Settings"
5. "Priorities for telephones"
6. Select the desired device.
7. Select the desired priority by sliding.

Bluetooth connection

Functional requirements

- ▷ Compatible device with Bluetooth interface.
Compatible devices, refer to page 74.
- ▷ The vehicle key is in the vehicle.
- ▷ The device is ready for operation.
- ▷ Bluetooth is switched on in the vehicle and on the device.
- ▷ The pairing readiness is displayed on the Control Display.
- ▷ Bluetooth presettings, such as visibility, may be required on the device; refer to the operating instructions of the device.

Activate Bluetooth

1. "COM"
2. "Mobile devices"
3. Tilt the Controller to the right.
4. "Settings"
5. "Bluetooth®"
6. Select setting.

Connecting the device

1. "COM"
2. "Mobile devices"
3. Tilt the Controller to the right.
4. "New device"
5. "Phone calls and audio"
The vehicle's Bluetooth name is displayed on the Control Display.
6. Compare the control number displayed on the Control Display with the control number on the display of the mobile device, and confirm that the two match.
7. A Bluetooth connection is established.

The mobile device is connected to the vehicle and displayed in the device list.

Frequently Asked Questions

All requirements are met and all required steps were completed in the specified order. Despite that, the mobile device does not function as expected.

In this case, the following explanations can help:

Why could the mobile phone not be paired or connected?

- ▷ There are too many Bluetooth devices connected to the mobile phone or vehicle.

In the vehicle, delete Bluetooth connections with other devices.

Delete the Bluetooth connection from the device list on the mobile phone and start a new device search.

Too many Bluetooth devices with the same function are paired.

- ▷ The mobile phone is in power-save mode or has only a limited remaining battery life.

Charge the mobile phone and deactivate the power-save mode where required.

Why does the mobile phone no longer react?

- ▷ The applications on the mobile phone do not function anymore.

Switch the mobile phone off and on again.

- ▷ Too high or too low ambient temperature for mobile phone operation.

Do not subject the mobile phone to extreme ambient temperatures.

Why can telephone functions not be used via iDrive?

- ▷ Phone functions are not configured for the mobile phone.

Connect the mobile phone with the telephone function.

Why are no or not all telephone book entries displayed or why are they incomplete?

- ▷ Transmission of the telephone book entries is not yet complete.
- ▷ It is possible that only the telephone book entries of the mobile phone or the SIM card are transmitted.
- ▷ It may not be possible to display telephone book entries with special characters.
- ▷ It may not be possible to transmit contacts from social networks.
- ▷ The number of phone book entries to be transmitted is too high.
- ▷ Data volume of the contact too large, for instance due to stored information such as memos.
Reduce the data volume of the contact.
- ▷ A mobile phone can only be connected as audio source or as telephone.
Configure the mobile phone and connect it with the telephone function.
- ▷ Contact was created in the contact list of the phone after the last synchronization.
Synchronize contacts again: "Reload contacts"

How can the telephone connection quality be improved?

- ▷ Adjust the strength of the Bluetooth signal on the mobile phone, depending on the mobile phone.
- ▷ Insert the mobile phone into the wireless charging tray.
- ▷ Adjust the volume of the microphone separately in the sound settings.

If all points in this list have been checked and the required function is still not available, contact Customer Relations, a dealer's service center or another qualified service center or repair shop.

WLAN connection

General information

For certain applications, such as apps, the data exchange between smartphone and vehicle occurs via WLAN.

Functional requirements

- ▷ Standby state is switched on.
- ▷ Compatible device with activated WLAN interface.

Activate WLAN in the vehicle

1. "COM"
2. "Mobile devices"
3. Tilt the Controller to the right.
4. "Settings"
5. "Wi-Fi@"

Wi-Fi hotspot

Principle

Compatible devices with WLAN interface can use the Internet connection of the vehicle via the Wi-Fi hotspot.

General information

Up to ten devices can be connected to the Wi-Fi hotspot simultaneously.

Functional requirements

- ▷ Compatible device with activated WLAN interface.
Compatible devices, refer to page 74.
- ▷ WLAN is activated on the vehicle.
- ▷ Internet use is activated for the vehicle.
- ▷ Registration and data contract with a service provider where required.
- ▷ Standby state is switched on.

Connecting a device to the Internet via the Wi-Fi hotspot

Using the Internet for the first time via the Wi-Fi hotspot requires registration and possibly a data volume purchase from a service provider.

Depending on the country version, data volume can be purchased via the connected mobile device or from the ConnectedDrive Store.

1. "COM"
2. "Mobile devices"
3. Tilt the Controller to the right.
4. "New device"
5. "Internet, apps"
Hotspot name and hotspot code are displayed on the Control Display.
6. Activate Internet usage via WLAN if necessary.
"Open settings"
7. Activate Internet usage.
"Internet connection"
8. Tilt the Controller to the left.
9. Search for WLAN networks on the mobile device. Select network name on the device.
10. Enter hotspot code on the device and connect.

The device is displayed in the device list.

Additionally, a QR code will be displayed on the Control Display. Alternatively, this QR code can be used to pair the mobile device with the hotspot.

All devices connected via the hotspot use this data volume.

Deactivating Internet usage via the Wi-Fi hotspot

Internet usage may be deactivated if the data volume is used up, for instance.

1. "COM"
2. "Mobile devices"

3. Tilt the Controller to the right.
4. "Settings"
5. "Internet connection"
6. Select the desired setting.

Screen Mirroring

General information

Screen Mirroring enables mirroring (outputting) of the smartphone display on the Control Display.

Functional requirements

- ▶ Compatible smartphone with Screen Mirroring interface.
Compatible devices, refer to page 74.
- ▶ Screen Mirroring is activated on the smartphone.
- ▶ WLAN is activated on the vehicle.

Pairing a smartphone with Screen Mirroring

1. "COM"
2. "Mobile devices"
3. Tilt the Controller to the right.
4. "New device"
5. "Screen Mirroring"
The WLAN name of the vehicle is displayed on the Control Display.
6. Search for WLAN devices in the surrounding area of the smartphone.
The WLAN name of the vehicle appears on the device display. Select the WLAN name of the vehicle.
7. Confirm the connection via iDrive.

The device is connected and displayed in the device list.

Apple CarPlay® preparation

Principle

CarPlay allows certain functions of a compatible Apple iPhone to be used via Siri voice control and iDrive.

Functional requirements

- ▶ Compatible iPhone, iPhone 5 or later with iOS 7.1 or later.
Compatible devices, refer to page 74.
- ▶ Corresponding mobile contract.
- ▶ Bluetooth, WLAN, and Siri voice control are activated on the iPhone.
- ▶ If necessary, the setting for mobile data must be activated on the iPhone.
- ▶ Booking the ConnectedDrive service: smartphone integration.
- ▶ WLAN and Bluetooth are enabled in the vehicle.

Pairing the iPhone with CarPlay

1. "COM"
2. "Mobile devices"
3. Tilt the Controller to the right.
4. "New device"
5. "Phone calls and audio"
The vehicle's Bluetooth name is displayed on the Control Display.
6. On the mobile device, search for Bluetooth devices in the vicinity and select the vehicle.
A control number is displayed.
7. Compare the control number displayed on the Control Display with the control number on the display of the mobile device, and confirm that the two match.
8. "Use Apple CarPlay"

The iPhone is connected to the vehicle and displayed in the device list.

Operation

For more information, refer to the Integrated Owner's Manual or the Owner's Manual for Navigation, Entertainment, Communication.

Frequently Asked Questions

All requirements are met and all required steps were completed in the specified order. Despite that, the mobile device does not function as expected.

In this case, the following explanations can help:

The iPhone has already been paired with Apple CarPlay. When a new connection is set up, CarPlay can no longer be selected.

- ▶ Delete the iPhone concerned from the device list.
- ▶ On the iPhone, delete the vehicle concerned from the list of stored connections under Bluetooth and under WLAN.
- ▶ Pair the iPhone as a new device.

If the steps listed have been carried out and the required function is still not available: contact Customer Relations, a dealer's service center or another qualified service center or repair shop.

Android Auto® preparation

Principle

Android Auto allows the operation of certain functions of a compatible smartphone via voice control and iDrive.

General information

The range of services offered depends on the country.

Functional requirements

- ▶ Compatible Android smartphone: Samsung or Google smartphone with Android 10 or an

Android smartphone with Android 11, regardless of the manufacturer.

- ▷ Compatible devices, refer to page 74.
- ▷ Corresponding mobile contract.
- ▷ Bluetooth and WLAN are enabled on the smartphone.
- ▷ The smartphone must support a 5 Ghz WiFi connection.
- ▷ If necessary, the setting for mobile data must be activated on the smartphone.
- ▷ WLAN and Bluetooth are enabled in the vehicle.

Pairing a smartphone with Android Auto

1. "COM"
2. "Mobile devices"
3. Tilt the Controller to the right.
4. "New device"
5. "Phone calls and audio"

The vehicle's Bluetooth name is displayed on the Control Display.
6. On the mobile device, search for Bluetooth devices in the vicinity and select the vehicle.

A control number is displayed.
7. Compare the control number displayed on the Control Display with the control number on the display of the mobile device, and confirm that the two match.
8. "Use Android Auto"
9. If necessary, finish the setup on the mobile device.

The smartphone is connected to the vehicle and displayed in the device list.

Operation

For more information, refer to the Integrated Owner's Manual or the Owner's Manual for Navigation, Entertainment, Communication.

Frequently Asked Questions

All requirements are met and all required steps were completed in the specified order. Despite that, the mobile device does not function as expected.

In this case, the following explanations can help:

The smartphone has already been paired with Android Auto. When a new connection is set up, Android Auto can no longer be selected.

- ▷ Delete the smartphone concerned from the device list.
- ▷ On the smartphone, delete the vehicle concerned from the list of stored connections under Bluetooth and under WLAN.
- ▷ Pair the smartphone as a new device.

If the steps listed have been carried out and the required function is still not available: contact Customer Relations, a dealer's service center or another qualified service center or repair shop.

USB connection

General information

The following mobile devices can be connected to the USB port:

- ▷ Mobile phones.
- ▷ Audio devices such as MP3 players.
- ▷ USB storage devices.

Common file systems are supported. FAT32 and exFAT are the recommended formats.

A connected USB device will be supplied with charge current via the USB port if the device supports this. Follow the maximum charge current of the USB port.

The following uses are possible on USB ports with data transmission:

- ▷ Playing music files.
- ▷ Playing videos.

Follow the following when connecting:

- ▶ Do not use force when plugging the connector into the USB port.
- ▶ Use a flexible adapter cable.
- ▶ Protect the USB device against mechanical damage.
- ▶ Due to the large number of USB devices available on the market, it cannot be guaranteed that every device is operable on the vehicle.
- ▶ Do not expose USB devices to extreme environmental conditions, such as very high temperatures; refer to the operating instructions of the device.
- ▶ Due to the many different compression techniques, proper playback of the media stored on the USB device cannot be guaranteed in all cases.
- ▶ To ensure proper transmission of the stored data, do not charge a USB device via the on-board socket, when it is connected to the USB port.
- ▶ Depending on how the USB device is being used, settings may be required on the USB storage device, refer to the operating instructions of the device.

Additional information:
USB port, refer to page [288](#).

Not compatible USB devices:

- ▶ USB hard drives.
- ▶ USB hubs.
- ▶ USB memory card readers with multiple slots.
- ▶ HFS-formatted USB devices.
- ▶ Devices such as fans or lamps.

Functional requirement

Compatible device with USB port.

Additional information:

Compatible devices, refer to page [74](#).

Connecting the device

Connect the USB device using a suitable adapter cable to a USB port.

The USB device is displayed in the device list.

Opening and closing

Vehicle features and options

This chapter describes all standard, country-specific and optional features offered with the series. It also describes features and functions that are not necessarily available in your vehicle, e.g., due to the selected options or country versions. This also applies to safety-related functions and systems. When using these functions and systems, the applicable laws and regulations must be observed.

Vehicle key

General information

The vehicle is supplied with two vehicle keys with integrated key.

Each vehicle key contains a replaceable battery.

Depending on the equipment and country version, various settings can be configured for the button functions.

A driver profile with personal settings can be assigned to a vehicle key.

To provide information on maintenance recommendations, the service data is stored in the vehicle key.

To prevent possible locking in of the vehicle key, take the vehicle key with you when exiting the vehicle.

Safety information

Warning

The vehicle key has a button cell battery. Batteries or button cells can be swallowed and lead to serious or fatal injuries within two hours, for example, due to internal burns or chemical

burns. There is an injury hazard or danger to life. Keep the vehicle key and batteries out of reach for children. Immediately seek medical help if there is any suspicion that a battery or button cell has been swallowed or is located in any part of the body.

Warning

People or animals in the vehicle can lock the doors from the inside and lock themselves in. In this case, the vehicle cannot be opened from the outside. There is a risk of injury. Take the vehicle key with you so that the vehicle can be opened from the outside.

Warning

For some country versions, unlocking from the inside is only possible with special knowledge.

Persons who spend a lengthy time in the vehicle while being exposed to extreme temperatures are at risk of injury or death. Do not lock the vehicle from the outside when there are people in it.

Warning

Unattended children or animals in the vehicle can cause the vehicle to move and endanger themselves and traffic, for instance due to the following actions:

- ▷ Pressing the Start/Stop button.
- ▷ Releasing the parking brake.
- ▷ Opening and closing the doors or windows.
- ▷ Engaging selector lever position N.
- ▷ Using vehicle equipment.

There is a risk of accidents or injuries. Do not leave children or animals unattended in the vehicle. Take the vehicle key with you when exiting and lock the vehicle.

Overview

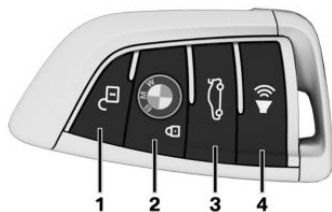

- 1 Unlocking
- 2 Locking
Stationary climate control through Remote Engine Start [279](#)
- 3 Opening the trunk lid
- 4 Panic mode, pathway lighting

Unlocking

General information

The behavior of the vehicle during unlocking using the vehicle key depends on the following settings:

- ▶ If only the driver's door and the fuel filler flap or all access to the vehicle will be unlocked when the button is pressed for the first time.
- ▶ If the unlocking of the vehicle is confirmed with a light signal or a sound signal.
- ▶ If the welcome light is switched on when the vehicle is being unlocked.
Welcome lights, refer to page [173](#).

Unlocking the vehicle



Press the button on the vehicle key.

If, due to the settings, only the driver's door and fuel filler flap were unlocked, press the button on the vehicle key again to unlock the other vehicle access points.

In addition, the following functions are executed:

- ▶ If a driver profile was assigned to the vehicle key, this driver profile will be activated and the settings that are stored in it will be applied.
- ▶ The interior lights are switched on, unless they were manually switched off.
- ▶ Folded in exterior mirrors are folded out.
If the exterior mirrors were folded in via the button in the car's interior, they will not be folded out when unlocking.
- ▶ With alarm system: The alarm system will be switched off.

After opening one of the front doors, the vehicle is ready for operation.

The light functions may depend on the ambient brightness.

Convenient opening



Press and hold the button on the vehicle key after unlocking.

The windows and the glass sunroof with sun protection are opened, as long as the button on the vehicle key is pressed.

Locking

General information

The behavior of the vehicle during locking using the vehicle key depends on the following settings:

- ▶ If the locking of the vehicle is confirmed with a light signal or a sound signal.
- ▶ If the exterior mirrors are automatically folded in when the vehicle is locked. The exterior mirrors are not folded in when the hazard warning flashers are switched on.
- ▶ If pathway lighting is activated during locking.

Locking the vehicle

1. Close the driver's door.
2.  Press the button on the vehicle key.

The following functions are executed:

- ▷ All doors, the trunk lid, and the fuel filler flap are locked.
- ▷ With alarm system: The alarm system will be switched on.

If the drive-ready state is still switched on when you lock the vehicle, the vehicle horn honks twice. In this case, the drive-ready state must be switched off by means of the Start/Stop button.

With Comfort Access: convenient closing

Safety information

Warning

With convenient closing, body parts can be jammed. There is a risk of injury. Make sure that the area of movement of the doors is clear during convenient closing.

Closing

 Press and hold the button on the vehicle key in the area close to the vehicle after locking.

The windows and the glass sunroof with sun protection are closed, as long as the button on the vehicle key is pressed.

The exterior mirrors are folded in unless they were folded in during locking. The exterior mirrors are not folded in when the hazard warning flashers are switched on.

Switching on the interior and exterior lighting

 Press the button on the vehicle key with the vehicle locked.

The function is not available for the first 10 seconds after locking.

- ▷ The interior lights are switched on, unless they were manually switched off.
Interior lights, refer to page 177.
- ▷ Depending on the settings, parts of the exterior lighting will be switched on.

The light functions may depend on the ambient brightness.

Trunk lid

General information

To avoid locking the vehicle key in the vehicle, do not place the vehicle key in the cargo area.

Depending on the vehicle equipment and country version, it is possible to specify whether the trunk lid can be unlocked with the vehicle key and how the vehicle doors will respond to this.

With automatic transmission: selector lever position P must be engaged to open the trunk lid with the vehicle key.

Safety information

Warning

Body parts can be jammed when operating the trunk lid. There is a risk of injury. Make sure that the area of movement of the trunk lid is clear during opening and closing.

⚠ NOTICE

During opening, the trunk lid pivots back and up. There is a risk of damage to property, among other potential damage. Make sure that the area of movement of the trunk lid is clear during opening and closing.

Opening

Press and hold the button on the vehicle key for approx. 1 second.

Switching pathway lighting on

Press and hold the button on the vehicle key for approx. 1 second.

It is possible to adjust the duration of the pathway lighting feature.

Additional information:

Pathway lighting, refer to page 173.

Replacing the battery**⚠ NOTICE**

Improper batteries in the vehicle key can damage the vehicle key. There is a risk of damage to property, among other potential damage. Always replace the discharged battery with a battery with the same voltage, the same size and the same specification.

1. Remove the integrated key from the vehicle key.
Integrated key, refer to page 91.
2. Place the integrated key underneath the battery compartment cover, arrow 1, and lift the

cover with a lever movement of the integrated key, arrow 2.

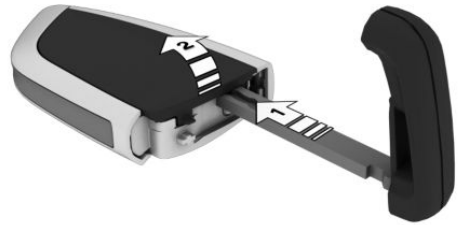

3. Push battery in arrow direction using a pointed object and lift it out.

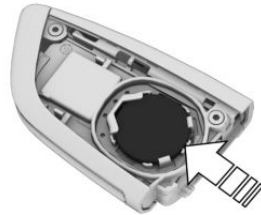

4. Insert a type CR 2032 3V battery with the positive side facing up.
5. Press the cover closed.
6. Push the integrated key into the vehicle key until the integrated key engages.



Have old batteries disposed of by a dealer's service center or another qualified service center or repair shop or take them to a collection point.

Additional vehicle keys

Additional vehicle keys are available from a service center or another qualified service center or repair shop.

Loss of vehicle keys

A lost vehicle key can be disabled and replaced by a dealer's service center or another qualified service center or repair shop.

If the lost vehicle key has an assigned driver profile, the connection to this vehicle key must be deleted. A new vehicle key can then be assigned to the driver profile.

Malfuction

General information

A Check Control message is displayed.

Vehicle key detection by the vehicle may malfunction under the following circumstances:

- ▶ The battery of the vehicle key is discharged.
- ▶ Fault of the radio link from transmission towers or other equipment with high transmitting power.
- ▶ Shielding of the vehicle key due to metal objects.
Do not transport the vehicle key together with metal objects.
- ▶ Fault of the radio link from mobile phones or other electronic devices in direct proximity to the vehicle key.
Do not carry the vehicle key in close proximity to other electronic devices.
- ▶ Fault of radio transmission by a charging process of mobile devices, for instance charging of a mobile phone.
- ▶ The vehicle key is located in direct proximity of the tray for wireless charging tray.
Place the vehicle key in a different location.

In the case of interference, the vehicle can also be unlocked and locked from the outside with the integrated key.

Additional information:

Integrated key, refer to page 91.

Switching the drive-ready state on via emergency detection of the vehicle key

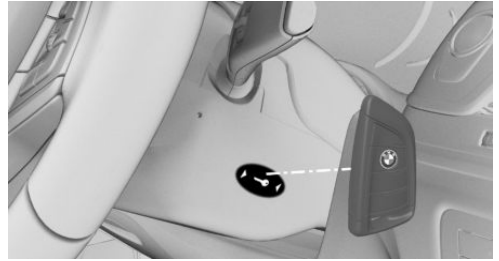

It is not possible to switch on the drive-ready state if the vehicle key has not been detected.

Proceed as follows in this case:

1. Hold the rear of the vehicle key against the marked area on the steering column. Pay attention to the display in the instrument cluster.
2. If the vehicle key is detected:
Turn on drive-ready state within 10 seconds.

If the vehicle key is not recognized, slightly change the position of the vehicle key and repeat the procedure.

Frequently Asked Questions

What precautions can be taken to be able to open a vehicle with an accidentally locked in vehicle key?

- ▶ The options provided by the Remote Services of the BMW app include the ability to lock and unlock a vehicle.
This requires an active BMW ConnectedDrive contract and the BMW app must be installed on a smartphone.
- ▶ Unlocking the vehicle can be requested via the BMW ConnectedDrive Call Center.
An active BMW ConnectedDrive contract is required.

Key Card

Principle

The Key Card allows the vehicle to be unlocked and locked, as well as started.

General information

The Key Card is available with Comfort Access and Steptronic transmission. Depending on the national-market version, the Key Card may not be available.

A digital key that has already been paired with the vehicle is installed on the Key Card. The digital key must be activated via iDrive.

Before leaving the vehicle, deactivate the Key Card or take the Key Card with you because the active Key Card can be used to start the vehicle. Always take the vehicle key with you to a service appointment.

Safety information

Warning

People or animals in the vehicle can lock the doors from the inside and lock themselves in. In this case, the vehicle cannot be opened from the outside. There is a risk of injury. Take the vehicle key with you so that the vehicle can be opened from the outside.

Warning

For some country versions, unlocking from the inside is only possible with special knowledge.

Persons who spend a lengthy time in the vehicle while being exposed to extreme temperatures are at risk of injury or death. Do not lock the vehicle from the outside when there are people in it.

Warning

Unattended children or animals in the vehicle can cause the vehicle to move and endanger themselves and traffic, for instance due to the following actions:

- ▷ Pressing the Start/Stop button.
- ▷ Releasing the parking brake.
- ▷ Opening and closing the doors or windows.
- ▷ Engaging selector lever position N.
- ▷ Using vehicle equipment.

There is a risk of accidents or injuries. Do not leave children or animals unattended in the vehicle. Take the vehicle key with you when exiting and lock the vehicle.

Connection to the vehicle

The communication between the vehicle and the Key Card uses near field communication, NFC.

Activating/deactivating Key Card in the vehicle

General information

The Key Card must be located in the smart-phone tray and a vehicle key must be located in the vehicle to activate the Key Card.

A vehicle key must be located in the vehicle to deactivate the Key Card.

When BMW Digital Key is activated for the vehicle, a digital key can be used instead of the vehicle key.

A deactivated Key Card remains in the list of paired digital keys.

Activate Key Card

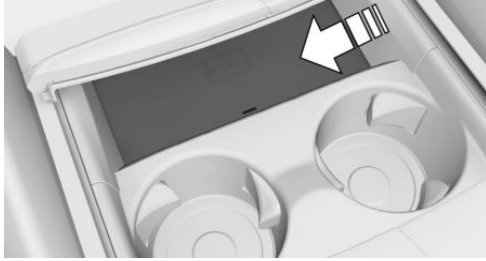

1. Open the cover of the smartphone tray.
2. Place Key Card centered into the smartphone tray.
3. Follow the instructions on the Control Display to activate the Key Card.

Deactivate Key Card

1. "CAR"
2. "Settings"
3. "Doors/ vehicle access"
4. "Digital Key"
5. Select Key Card.
6. "Key active"

A deactivated Key Card remains in the list of paired digital keys.

Unlocking and locking the vehicle

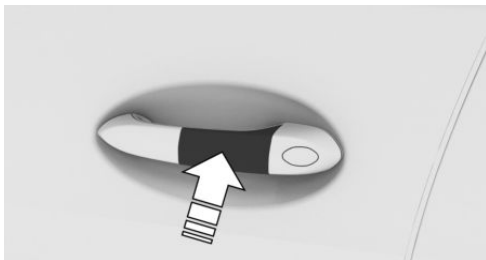

Hold activated Key Card directly and centered on the external door handle of the driver's door.

If the Key Card is not detected, slightly change the position of the Key Card and repeat the procedure.

Starting the engine

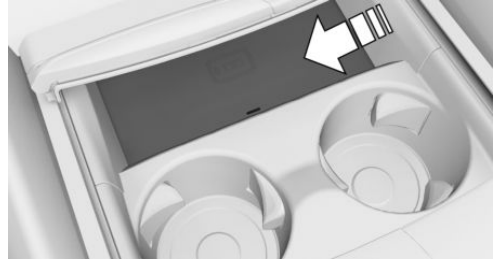

1. Open the cover of the smartphone tray.
2. Place activated Key Card centered into the smartphone tray.
3. Press the Start/Stop button to start the engine.

With wireless charging tray: After starting the engine, take the Key Card out of the tray to make tray available for charging compatible smartphones.

Malfunction

The detection of the Key Card by the vehicle may be disrupted by objects between the sensors and the Key Card, for instance a wallet.

BMW Digital Key

Principle

BMW Digital Key allows the vehicle to be unlocked and locked, as well as started, with a compatible smartphone.

General information

The availability of the BMW Digital Key depends on the equipment and national-market version.

BMW Digital Key can be used with a compatible smartphone or other compatible mobile terminals, such as a Smartwatch.

To unlock and start a vehicle with a compatible smartphone, this function must be offered by the smartphone manufacturer. The BMW app provides a check to determine if the smartphone and the vehicle are compatible.

A driver profile with individual settings can be assigned to a digital key.

Additional information:

Driver profiles, refer to page 69.

When using a smartphone as a digital key, always carry a vehicle key or the activated Key Card with you. This ensures access to the vehicle, even in the event of a smartphone failure. It is also useful to carry the vehicle key or the Key Card with you if the vehicle has to be handed over to another person. You can then hand over the vehicle key or the Key Card, instead of your smartphone. Always take the vehicle key with you to a service appointment.

Safety information

Warning

People or animals in the vehicle can lock the doors from the inside and lock themselves in. In this case, the vehicle cannot be opened from the outside. There is a risk of injury. Take the vehicle key with you so that the vehicle can be opened from the outside.

Warning

For some country versions, unlocking from the inside is only possible with special knowledge. Persons who spend a lengthy time in the vehicle while being exposed to extreme temperatures are at risk of injury or death. Do not lock the vehicle from the outside when there are people in it.

Warning

Unattended children or animals in the vehicle can cause the vehicle to move and endanger themselves and traffic, for instance due to the following actions:

- ▷ Pressing the Start/Stop button.
- ▷ Releasing the parking brake.
- ▷ Opening and closing the doors or windows.
- ▷ Engaging selector lever position N.
- ▷ Using vehicle equipment.

There is a risk of accidents or injuries. Do not leave children or animals unattended in the vehicle. Take the vehicle key with you when exiting and lock the vehicle.

Connection to the vehicle

The communication between the vehicle and the smartphone uses near field communication, NFC.

Functional requirements

- ▷ The smartphone is compatible with BMW Digital Key
- ▷ The vehicle is linked with the Connected-Drive account of the vehicle owner.
- ▷ The rechargeable battery of the smartphone has a sufficient charge. The necessary minimum charge of the rechargeable battery depends on the smartphone.

Enable the digital remote control key

Vehicle owner's smartphone is enabled as a digital remote control key in the vehicle. The vehicle owner must prove his authorization for the vehicle for this purpose.

The proof of authorization can be started via the BMW app or via the activation code in the corresponding smartphone function, for instance the

Wallet app. Both vehicle keys must be located in the vehicle to be enabled.

Follow the instructions in the Digital Key menu in the BMW app or on the Control Display.

The valid service period of the digital key may be limited. The expiration date of the validity can be checked in the BMW app.

After a digital key has expired, it can still be used to move the vehicle until the vehicle is used with a different vehicle key or digital key.

Sharing digital keys

General information

Digital key allows the sharing of digital keys with other people. This option is available via the smartphone that is enabled as digital remote control key.

Forwarding authorization

To share the digital key, select the corresponding function on the smartphone, for instance in the Wallet app.

As soon as a digital key is shared with another person, the person will receive an invitation. When the invitation is accepted, the digital key on the recipient's smartphone will be activated.

Limiting the range of functions

Certain functions of the digital key can be limited before handing it over. For example, if the digital key is handed over to a novice driver, the switch-off of driving stability control system can be excluded. For more information, refer to the ConnectedDrive portal and the BMW app.

Authentication

Depending on the recipient's smartphone model, an authentication may be required for security and safety reasons.

An authorized vehicle key, the digital remote control key or another method may be used for

authentication. Follow the corresponding instructions on the smartphone or the Control Display.

Deleting a shared key

General information

Shared keys can be deleted via the smartphone with the digital remote control key, the smartphone with a shared key or via iDrive.

The deletion via the smartphone with the digital remote control key will not be performed until the vehicle is used with a key other than the key to be deleted.

The deletion via the smartphone with a shared key or via iDrive is executed immediately.

Deleted digital keys will be removed from the list of enabled digital keys.

Deleted digital keys cannot be restored.

Deletion via iDrive

To be able to delete a digital key via iDrive, an authorized vehicle key must be located in the vehicle or the remote control key must be located in the smartphone tray.

1. "CAR"
2. "Settings"
3. "Doors/ vehicle access"
4. "Digital Key"
5. If necessary, select the digital key.
6. "Delete key"

Reset the function

To reset the BMW Digital Key function, an authorized vehicle key must be located in the vehicle.

When resetting the BMW Digital Key function, all digital keys including the digital remote control key will be deleted.

After the reset, the vehicle can no longer be unlocked, locked or started with a digital key.

The digital remote control key must be enabled again to be able to use BMW Digital Key again.

1. "CAR"
2. "Settings"
3. "Doors/ vehicle access"
4. "Digital Key"
5. "Reset function"

Unlocking and locking the vehicle

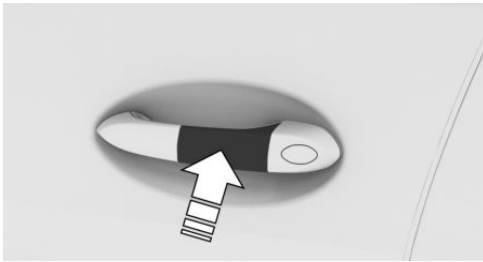

Hold the near field communication antenna of the smartphone directly and centered on the external door handle of the driver's door.

The position of the near field communication antenna depends on the smartphone model.

When locking the vehicle with the smartphone, make sure that all doors including the trunk lid are closed.

Starting the engine



1. Open the cover of the smartphone tray.
2. Place smartphone centered into the smartphone tray.

Ensure that the display is facing up.

3. Close the cover of the smartphone tray.
4. Press the Start/Stop button to start the engine.

Sale of the smartphone

Delete all digital keys on the smartphone prior to selling the smartphone. This ensures that that the smartphone can no longer be used for the vehicle.

Sale of the vehicle

Prior to selling a vehicle, reset the Digital Key function or remove the vehicle from the ConnectedDrive account of the current vehicle owner.

When the vehicle is removed from the ConnectedDrive account, all digital keys for the vehicle will be deleted.

Malfunction

Digital key recognition by the vehicle may malfunction under the following circumstances:

- ▶ The smartphone is shielded from the sensors in the vehicle by a smartphone cover that is not suitable.
- ▶ Objects such as a chip card or the Key Card are located between the smartphone and the smartphone cover.

Integrated key

General information

The driver's door can be locked and unlocked without the vehicle key using the integrated key.

Depending on the national-market version, the integrated key also fits the glove compartment.

Safety information

Warning

For some country versions, unlocking from the inside is only possible with special knowledge.

Persons who spend a lengthy time in the vehicle while being exposed to extreme temperatures are at risk of injury or death. Do not lock the vehicle from the outside when there are people in it.

NOTICE

The door lock is permanently joined with the door. The door handle can be moved. When pulling the door handle with the integrated key inserted, paint or the integrated key can be damaged. There is a risk of damage to property, among other potential damage. Remove the integrated key before pulling the external door handle.

Removing

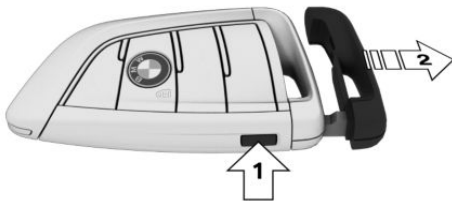

Press the button, arrow 1, and pull out the integrated key, arrow 2.

Locking/unlocking via the door lock

1. Pull and hold the door handle outward with one hand.

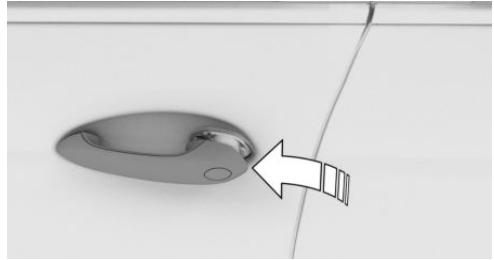

2. Guide one finger of your other hand from the back under the cover and push the cover out. Use the thumb for counter support to prevent the cover from falling out of the door handle.

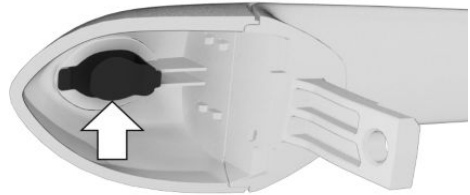

3. Remove the cover.
4. Unlock or lock the door lock using the integrated key.

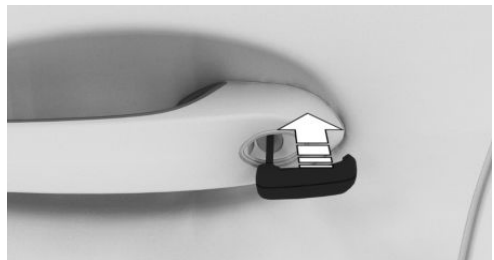

The other doors must be unlocked or locked from the inside.

Alarm system

The activated alarm system is triggered when the door is opened, if the vehicle has been unlocked via the door lock.

The alarm system is not switched on if the vehicle is locked with the integrated key.

Buttons for the central locking system

General information

In the event of a severe accident, the vehicle is automatically unlocked. The hazard warning system and interior lights come on.

Overview



Buttons for the central locking system.

Locking

 Press the button with the front doors closed.

- ▷ The fuel filler flap remains unlocked.
- ▷ The vehicle is not secured against theft when locking.

Unlocking

 Press the button.

Opening

- ▷  Press the button to unlock all the doors.

Pull the door opener above the armrest.

- ▷ Front doors: pull the door handle on the door to open the door. The other doors remain locked.
- ▷ Back doors: pull twice on the door handle on the door to be opened; the first time unlocks the door, the second time opens it. The other doors remain locked.

Comfort Access

Principle

The vehicle can be accessed without operating the vehicle key.

Carrying the vehicle key with you, e.g., in your pants pocket, is sufficient.

The vehicle automatically detects the vehicle key when it is in close proximity or in the car's interior.

General information

Comfort Access supports the following functions:

- ▷ Unlocking and locking the vehicle from the door handle.
- ▷ Convenient closing.
- ▷ Touchless unlocking and locking of the vehicle.
- ▷ Steptronic transmission: unlocking and locking the vehicle using the BMW Digital Key.
- ▷ Opening trunk lid.
- ▷ Opening and closing the trunk lid with no-touch activation.

Functional requirements

- ▷ To lock the vehicle, the vehicle key must be outside of the vehicle near the doors.
- ▷ The next unlocking and locking cycle is not possible until after approx. 2 seconds.

Unlocking

General information

The behavior of the vehicle during unlocking via the Comfort Access depends on the following settings:

- ▷ If the unlocking of the vehicle is confirmed with a light signal or a sound signal.
- ▷ If the welcome light is switched on when the vehicle is being unlocked.

Unlocking the vehicle

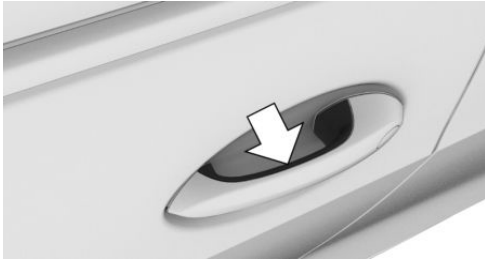

Grasp the handle of a vehicle door completely.

In addition, the following functions are executed:

- ▷ If a driver profile was assigned to the vehicle key, this driver profile will be activated and the settings that are stored in it will be applied.
- ▷ The interior lights are switched on, unless they were manually switched off.
- ▷ Folded in exterior mirrors are folded out.
If the exterior mirrors were folded in via the button in the car's interior, they will not be folded out when unlocking.
- ▷ With alarm system: The alarm system will be switched off.

Locking

General information

The behavior of the vehicle during locking via the Comfort Access depends on the following settings:

- ▷ If the locking of the vehicle is confirmed with a light signal or a sound signal.
- ▷ If the exterior mirrors are automatically folded in when the vehicle is locked. The exterior mirrors are not folded in when the hazard warning flashers are switched on.
- ▷ If pathway lighting is activated during locking.

Locking the vehicle

Close the driver's door.

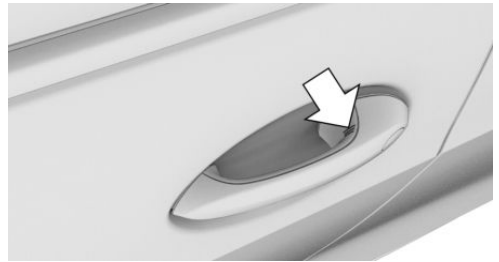

Touch the grooved surface on the handle of a closed vehicle door with your finger for approx. 1 second without grasping the door handle.

The following functions are executed:

- ▷ All doors, the trunk lid, and the fuel filler flap are locked.
- ▷ With alarm system: The alarm system will be switched on.

Convenient closing

Safety information

Warning

With convenient closing, body parts can be jammed. There is a risk of injury. Make sure that the area of movement of the doors is clear during convenient closing.

Closing

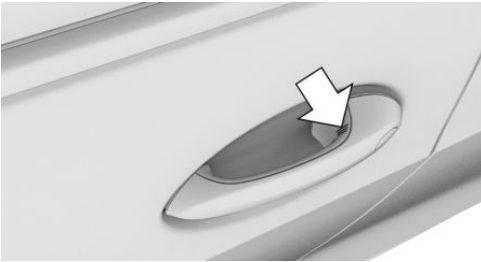

Touch the grooved surface on the handle of a closed vehicle door with your finger and hold it there without grasping the door handle.

In addition to locking, the windows and glass sunroof with sun protection will be closed.

The exterior mirrors are folded in unless they were folded in during locking. The exterior mirrors are not folded in when the hazard warning flashers are switched on.

Opening the trunk lid

General information

If you open the trunk lid via Comfort Access, locked doors will not be unlocked.

To avoid locking the vehicle key in the vehicle, do not place the vehicle key in the cargo area.

Safety information

Warning

Body parts can be jammed when operating the trunk lid. There is a risk of injury. Make sure that the area of movement of the trunk lid is clear during opening and closing.

NOTICE

During opening, the trunk lid pivots back and up. There is a risk of damage to property, among other potential damage. Make sure that the area of movement of the trunk lid is clear during opening and closing.

Opening

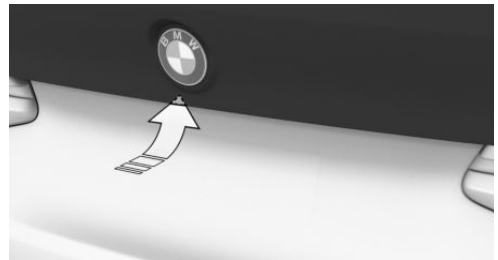

Press the button on the outer side of the trunk lid.

Opening and closing the trunk lid with no-touch activation

Principle

The trunk lid can be opened with no-touch activation using the vehicle key you are carrying. With automatic tailgate operation, it can also be closed with no-touch activation. Two sensors detect a forward-directed foot motion in the central rear area and the trunk lid is opened or closed.

General information

To avoid locking the vehicle key in the vehicle, do not place the vehicle key in the cargo area.

With automatic transmission: selector lever position P must be engaged for touchless opening of the trunk lid.

If the vehicle key is in the sensor area, the trunk lid may open or close inadvertently if you unintentionally move your foot or if a foot movement is detected.

The sensor has an approximate range of 5 ft/1.50 m extending from the rear of the vehicle.

If you open the trunk lid with no-touch activation, locked doors will not be unlocked.

Contactless opening and closing of the trunk lid must be activated in the settings.

Safety information

Warning

During no-touch activation, vehicle parts may be touched, such as the hot exhaust gas system. There is a risk of injury. When moving your foot, make sure you have a firm stance and do not touch the vehicle.

Warning

Body parts can be jammed when operating the trunk lid. There is a risk of injury. Make sure that the area of movement of the trunk lid is clear during opening and closing.

NOTICE

During opening, the trunk lid pivots back and up. There is a risk of damage to property, among other potential damage. Make sure that the area of movement of the trunk lid is clear during opening and closing.

Settings

Contactless opening and closing of the tailgate can be switched on or off.

1. "CAR"
2. "Settings"
3. "Doors/ vehicle access"
4. "Tailgate"

Performing the foot movement

1. Stand in the middle behind the vehicle at approx. one arm's length away from the rear end.
2. Wave a foot under the vehicle in the driving direction and immediately pull it back. With this movement, the leg must pass through the ranges of both sensors.



Opening

Perform the foot movement described earlier.

Before the trunk lid opens, the hazard warning system flashes.

With automatic tailgate: Moving your foot again will stop the opening motion, and moving it one more time after that will close the trunk lid.

Closing

The trunk lid can only be closed with no-touch activation if automatic tailgate operation is active.

Perform the foot movement described earlier.

The hazard warning system flashes and an acoustic signal sounds.

Moving your foot again will stop the closing motion, and moving it one more time after that will re-open the trunk lid.

System limits

The detection of the foot movement may be limited due to the following external conditions:

- ▷ Ice, snow or slush on the rear of the vehicle.
- ▷ Dirt or road salt on the rear of the vehicle.

Movement in the range of the sensors may cause unintended opening or closing of the cargo area, for instance due to water running down when cleaning the vehicle or with heavy rainfall. To prevent such unintended opening or closing of the cargo area in such cases, keep the vehicle key at a sufficient distance from the rear of the vehicle.

Touchless unlocking and locking of the vehicle

Principle

The vehicle will be unlocked when the driver approaches the locked vehicle with the vehicle key. When the driver walks away from the unlocked vehicle with the vehicle key, the vehicle will be locked.

General information

The vehicle will be unlocked when an authorized vehicle key is detected in the unlocking zone.

The unlocking zone is located within a radius of approx. 3 ft/1 m around the door handles.

The vehicle will be locked when the vehicle key leaves the locking zone.

The locking zone is located within a radius of approx. 7 ft/2 m around the door handles.

If the vehicle key is located in the unlocking zone for an extended period of time without movement, the vehicle will be locked automatically.

If a passenger is detected in the front passenger seat during locking and the safety belt of the

front passenger is engaged in the safety belt buckle during locking:

- ▷ The vehicle will be locked but not secured against theft.
- ▷ The fuel filler flap remains unlocked.

The behavior of the vehicle during touchless unlocking/locking depends on the following settings:

- ▷ If the automatic unlocking is active.
- ▷ If the automatic locking is active.
- ▷ If only the driver's door and the fuel filler flap or all access to the vehicle will be unlocked.

Only driver's door and fuel filler flap: the driver's door and fuel filler flap will only be unlocked when the driver approaches the vehicle on the driver's side.

All vehicle entry points: the vehicle will be unlocked regardless of the side on which the driver approaches the vehicle.

- ▷ If the unlocking and locking of the vehicle is confirmed with a light signal or a sound signal.
- ▷ If the welcome light is switched on when the vehicle is being unlocked.
- ▷ If pathway lighting is activated during locking.
- ▷ If the exterior mirrors are automatically folded out and in when the vehicle is unlocked and locked.

Functional requirements

- ▷ The drive-ready state must be turned off.
- ▷ Unlocking: when entering the unlocking zone, the doors and trunk lid must be closed.
- ▷ Locking: when leaving the locking zone, the doors and trunk lid must be closed.
- ▷ For touchless locking of the vehicle, no second vehicle key can be located in a radius of six meters around the vehicle.
- ▷ If the vehicle has been in the idle state for several days, touchless unlocking/locking is not possible until after the vehicle has been driven.

Malfunction

Vehicle key detection by the vehicle may malfunction under the following circumstances:

- ▷ The battery of the vehicle key is discharged.
For replacing the battery, refer to page 85.
- ▷ Fault of the radio link from transmission towers or other equipment with high transmitting power.
- ▷ Shielding of the vehicle key due to metal objects.
Do not transport the vehicle key together with metal objects.
- ▷ Fault of the radio link from mobile phones or other electronic devices in direct proximity to the vehicle key.
Do not carry the vehicle key in close proximity to other electronic devices.

Wet or snowy conditions may disrupt the locking request detection on the door handles.

In the case of a malfunction, unlock and lock the vehicle using the buttons of the vehicle key or use the integrated key.

Additional information:

Integrated key, refer to page 91.

Trunk lid

General information

To avoid locking the vehicle key in the vehicle, do not place the vehicle key in the cargo area.

Depending on the vehicle equipment and country version, it is possible to specify whether the trunk lid can be unlocked with the vehicle key and how the vehicle doors will respond to this.

With automatic transmission: selector lever position P must be engaged to open the trunk lid with the vehicle key.

It may not be possible to open the trunk lid when the vehicle is in valet parking mode.

Additional information:

Valet parking mode, refer to page 100.

Safety information

Warning

Body parts can be jammed when operating the trunk lid. There is a risk of injury. Make sure that the area of movement of the trunk lid is clear during opening and closing.

NOTICE

During opening, the trunk lid pivots back and up. There is a risk of damage to property, among other potential damage. Make sure that the area of movement of the trunk lid is clear during opening and closing.

Without automatic tailgate operation: opening and closing

Opening from the outside

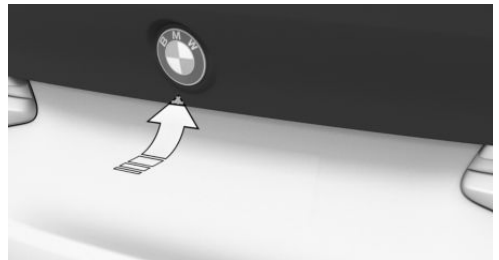

- ▷ Unlock the vehicle and then press the button on the outer side of the trunk lid.
- ▷ With Comfort Access: carry the vehicle key with you and press the button on the outer side of the trunk lid.
- ▷  Press and hold the button on the vehicle key for approx. 1 second.

When unlocking with the vehicle key, the doors may also be unlocked.

Open from inside

 Press or pull the button in the storage compartment of the driver's door.

Closing





Grasp the recess grips and pull the trunk lid down.

With automatic tailgate operation: opening and closing

Opening

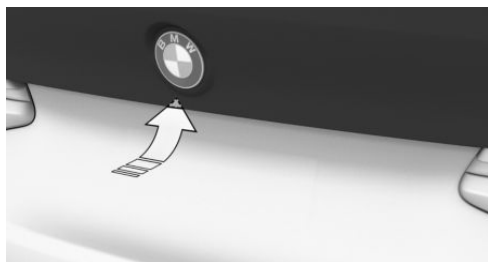
From the outside



- ▶ Unlock the vehicle and then press the button on the outer side of the trunk lid.
- ▶ With Comfort Access: carry the vehicle key with you and press the button on the outer side of the trunk lid.
- ▶  Press and hold the button on the vehicle key for approx. 1 second.

Depending on the setting, the doors may also be unlocked.

From the inside

 Press the button in the storage compartment of the driver's door.

Interruption of the opening procedure

The opening operation is interrupted:

- ▶ When the vehicle starts moving.
- ▶ By pressing the button on the outer side of the trunk lid. Pressing again closes the trunk lid.
- ▶ By pressing the button on the inside of the trunk lid. Pressing again closes the trunk lid.
- ▶ By pressing the button on the vehicle key. Pressing again continues the opening motion.
- ▶ By pressing or pulling the button in the driver's door. Pressing again continues the opening motion.

Closing

From the outside

- ▶  Press the button on the inside of the trunk lid.

With Comfort Access:

- ▶  Press the button on the inside of the trunk lid.

The vehicle will be locked after closing the trunk lid. The driver's door must be closed for this purpose and the vehicle key must be outside of the vehicle in the area of the trunk lid.

From the inside

 Pull and hold the button in the storage compartment of the driver's door.

The vehicle key must be located inside the vehicle for this function.

An acoustic signal sounds before the trunk lid is closed.

Interruption of the closing procedure

The closing procedure is interrupted in the following situations:

- ▷ If the vehicle starts off with a jerky movement.
- ▷ By pressing the button on the outer side of the trunk lid. Pressing again re-opens the trunk lid.
- ▷ By pressing the button on the inside of the trunk lid. Pressing again re-opens the trunk lid.
- ▷ By releasing the button in the driver's door. Pulling again and holding continues the closing motion.

Malfunction

In the event of an electrical malfunction, operate the unlocked trunk lid manually with a slow and smooth motion.

Trunk emergency unlocking



Pull the handle inside the cargo area.

The trunk lid unlocks.

Valet parking mode

Principle

In the valet parking mode, the Control Display is disabled. The operation via iDrive is no longer possible.

E.g., this mode can be used when the vehicle is handed over for valet parking.

General information

In the valet parking mode, it is not possible to change vehicle settings via iDrive. Personal profiles cannot be changed. Personal data cannot be displayed.

Additionally, the following actions are carried out:

- ▷ The volume of the audio system is limited.
- ▷ The integrated Universal Remote Control is deactivated.
- ▷ DSC cannot be switched off.
- ▷ Depending on the vehicle, the trunk lid can be locked and disconnected from the central locking system.

Functional requirements

- ▷ At least one driver profile has been created.
- ▷ A driver profile or the guest profile is active.
- ▷ At least one driver profile has an assigned ConnectedDrive account.

Accessing the menu for the valet parking mode

Via the switch-off screen

After switching off drive-ready state the switch-off screen will be displayed. Select the entry for the valet parking mode on the switch-off screen.

Via the display bar at the upper edge of the Control Display

1. Tip the Controller up.
2. "Valet parking mode"

Via the vehicle settings

1. "CAR"
2. "Settings"
3. "General settings"
4. "Valet parking mode"

Activating the valet parking mode

General information

Before activating the valet parking mode, a PIN must be set up to be able to deactivate the valet parking mode at a future time.

The procedure for entering the PIN varies depending on the active driver profile.

Driver profile with PIN

A PIN has been stored for the active driver profile.

It is not necessary to enter another PIN.

1. "Lock tailgate as well"

The trunk lid will be locked and disconnected from the central locking system.

2. "Activate now"

Driver profile without PIN

A PIN must be assigned to the driver profile.

1. "PIN"

2. Enter PIN.

3. "Lock tailgate as well"

4. "Activate linkage"

5. "Activate now"

Guest profile

The guest profile is the active driver profile.

A PIN must be entered.

1. "PIN"

2. Enter PIN.

3. "Lock tailgate as well"

The trunk lid will be locked and disconnected from the central locking system.

4. "Activate now"

This PIN can be used once to deactivate the valet parking mode for the active guest profile.

Deactivating valet parking mode

General information

The lock screen of the valet parking mode is displayed on the Control Display.

The deactivation of the valet parking mode depends on which driver profile is selected on the lock screen.

Driver profile with PIN

Regardless of which driver activated the valet parking mode, a driver can deactivate the valet parking mode by entering his/her PIN.

1. Select driver profile.

2. Enter the assigned PIN for the driver profile.

If you forgot the PIN, the valet parking mode must be deactivated by entering the assigned ConnectedDrive access data.

Driver profile without PIN

The valet parking mode was activated by another person. To deactivate the valet parking mode, a driver without a PIN has to enter the access data for his ConnectedDrive account.

1. Select driver profile.

2. Enter the ConnectedDrive access data assigned to the driver profile.

Guest profile

In the guest profile, the valet parking mode can only be deactivated if the valet parking mode was activated in the guest profile.

1. Select guest profile.

2. Enter the PIN that was specified during activation.

If the PIN has been forgotten, the valet parking mode must be deactivated via a personal driver profile.

Settings

General information

Depending on the vehicle equipment and country version, various settings for opening and closing are possible.

These settings are stored for the driver profile currently used.

Unlocking and locking

Doors

1. "CAR"
2. "Settings"
3. "Key button settings"
4.  Select the icon.
5. Select the desired setting:
 - ▷ "Driver's door only"

Only the driver's door and the fuel filler flap are unlocked. Pressing again unlocks the entire vehicle.
 - ▷ "All doors"

The entire vehicle is unlocked.

Confirmation signals from the vehicle

1. "CAR"
2. "Settings"
3. "Doors/ vehicle access"
4. Deactivate or activate the desired confirmation signals:
 - ▷ "Flash when locking/unlocking"

Unlocking is signaled by blinking twice, locking by blinking once.
 - ▷ With alarm system:

"Sound when locking/unlocking"

Unlocking is confirmed with two sound signals, locking is confirmed with one sound signal.

Folding mirrors in automatically

1. "CAR"
2. "Settings"
3. "Doors/ vehicle access"
4. "Fold mirrors in when locked"

Automatic unlocking

1. "CAR"
2. "Settings"
3. "Doors/ vehicle access"
4. Select the desired setting:
5. ▷ "Unlock doors when in Park"
 - ▷ "Unlock at end of trip"

After drive-ready state is switched off by pressing the Start/Stop button, the locked vehicle is automatically unlocked.

Automatic locking

1. "CAR"
2. "Settings"
3. "Doors/ vehicle access"
4. "Lock in a few minutes"

The vehicle locks automatically after a while if no door is opened after unlocking.

Trunk lid

Trunk lid and doors

You can set up if only the trunk lid will be unlocked or if the doors will also be unlocked when the trunk lid is unlocked

Depending on the vehicle equipment and country version, this setting may not be offered.

1. "CAR"
2. "Settings"
3. "Key button settings"
4.  Select the icon.

The text next to the icon indicates the current setting.

5. Select the desired setting:
 - ▷ "Tailgate"

Depending on the equipment, the trunk lid will be unlocked or opened.
 - ▷ "Tailgate and door(s)"

Depending on the equipment, the trunk lid will be unlocked or opened and the doors are unlocked.
 - ▷ "Tailgate opens only when vehicle is unlocked."

The vehicle must be unlocked before the trunk lid can be used with the vehicle key.
 - ▷ "Lock tailgate button"

The operation of the trunk lid via the vehicle key is disabled.

Comfort Access

Touchless locking and unlocking

Contactless locking and unlocking can be switched on or off.

1. "CAR"
2. "Settings"
3. "Doors/ vehicle access"
4. "Comfort access"

Establishing idle state after opening the front doors

1. "CAR"
2. "Settings"
3. "Doors/ vehicle access"
4. "Turn off vehicle after opening door"

Idle state, refer to page 41.

Alarm system

General information

When the vehicle is locked, the vehicle alarm system reacts to the following changes:

- ▷ Opening a door, the hood or the trunk lid.
- ▷ Movements in the car's interior.
- ▷ Changes in the vehicle tilt, for instance, during attempts at stealing a wheel or when towing the vehicle.
- ▷ Disconnected battery voltage.
- ▷ Improper use of the socket for OBD Onboard Diagnosis.
- ▷ Locking the vehicle while a device is connected to the socket for the OBD Onboard-Diagnosis.

The alarm system signals these changes visually and acoustically:

- ▷ Acoustic alarm:

Depending on local regulations, the acoustic alarm may be suppressed.
- ▷ Visual alarm:

By flashing of the hazard warning system and headlights, where required.

Do not modify the system to ensure function of the alarm system.

Turning on/off

The alarm system is switched on or off as soon as the vehicle is locked with the vehicle key or unlocked or locked via Comfort Access.

Opening the doors with the alarm system switched on

The alarm system is triggered when a door is opened if the door was unlocked using the integrated key in the door lock.

Opening the trunk lid with the alarm system switched on

The trunk lid can be opened even when the alarm system is switched on.

After the trunk lid is closed, it is locked and monitored again provided the doors are locked. The hazard warning system flashes once.

Panic mode

You can trigger the alarm system if you find yourself in a dangerous situation.



▶ Press the button on the vehicle key and hold for at least 3 seconds.

▶ Briefly press the button on the vehicle key three times in succession.

To switch off the alarm: press any button.

Indicator light on the interior mirror



▶ The indicator light flashes briefly every 2 seconds:

The alarm system is switched on.

▶ Indicator light flashes for approx. 10 seconds, then it flashes briefly every 2 seconds:

Interior motion sensor and tilt alarm sensor are not active, as doors, hood, or trunk lid are not correctly closed. Correctly closed access points are secured.

When the still open access points are closed, the interior motion sensor and tilt alarm sensor will be switched on.

▶ The indicator light goes out after unlocking:

The vehicle has not been tampered with.

▶ The indicator light flashes after unlocking until drive-ready state is switched on, but no longer than approx. 5 minutes:

An alarm has been triggered.

Tilt alarm sensor

The tilt of the vehicle is monitored.

The alarm system responds in situations such as attempts to steal a wheel or when the vehicle is towed.

Interior motion sensor

The windows and the glass sunroof must be closed for the system to function properly.

Avoiding unintentional alarms

General information

The tilt alarm sensor and interior motion sensor can trigger an alarm, although no unauthorized action occurred.

Possible situations for an unwanted alarm:

- ▶ In automatic car washes.
- ▶ In duplex garages.
- ▶ During transport on trains carrying vehicles, at sea or on a trailer.
- ▶ With animals in the vehicle.
- ▶ When the vehicle is locked after start of fueling.

The tilt alarm sensor and the interior motion sensor can be switched off in such situations.

Switching off the tilt alarm sensor and interior motion sensor



Press the button on the vehicle key within 10 seconds as soon as the vehicle is locked.

The indicator light lights up for approx. 2 seconds and then continues to flash.

The tilt alarm sensor and interior motion sensor are switched off until the vehicle is locked again.

Ending the alarm

- ▷ Unlock the vehicle with the vehicle key.
- ▷ Unlock the vehicle with the integrated key and activate the drive-ready state via emergency detection of the vehicle key.
Malfunction, refer to page 86.
- ▷ With Comfort Access: when carrying the vehicle key, grasp the driver's door or front passenger door handle completely.

Power windows

General information

The windows can be opened with the vehicle key from the outside as well as closed with Comfort Access.

With Comfort Access: The windows can be closed from the outside via Comfort Access.

When a window is often opened in the same position, this task can be performed by the BMW Intelligent Personal Assistant. For instance when the same parking garage is frequently used.

Additional information:

- ▷ Vehicle key, refer to page 82.
- ▷ BMW Intelligent Personal Assistant, refer to page 52.

Safety information

Warning

When operating the windows, body parts and objects can be jammed. There is a risk of injury or risk of damage to property. Make sure that the area of movement of the windows is clear during opening and closing.

Overview



 Power windows

 Safety switch



Functional requirements

The windows can be operated under the following conditions.



- ▷ Standby state is switched on.
- ▷ Drive readiness is switched on.

The vehicle key must be in the car's interior.

Opening

- ▷  Press the switch to the resistance point.
The window opens while the switch is being held.
- ▷  Press the switch beyond the resistance point.
The window opens automatically. Pressing the switch again stops the motion.

Closing

- ▷  Pull the switch to the resistance point.
The window closes while the switch is being held.
- ▷  Pull the switch beyond the resistance point.
The window closes automatically if the door is closed. Pulling again stops the motion.

Jam protection system

Principle

The jam protection prevents objects or body parts becoming jammed between the door frame and window while a window is being closed.

General information

If resistance or a blockage is detected while a window is being closed, the closing action is interrupted.



Safety information

Warning

Accessories on the windows such as antennas can impact jam protection. There is a risk of injury. Do not install accessories in the area of movement of the windows.

Closing without the jam protection system

In case of danger from the outside or if ice might prevent normal closing, proceed as follows:

-  Pull the switch past the resistance point and hold it there.
The window closes with limited jam protection. If the closing force exceeds a specific threshold, closing is interrupted.
-  Pull the switch past the resistance point again within approx. 4 seconds and hold it there.
The window closes without jam protection.

Safety switch

Principle

The safety switch can be used to prevent children, for instance from opening and closing the rear windows using the switches in the rear.

If an accident of a certain severity occurs, the safety function is switched off automatically.

Turning on/off



Press the button.

The LED lights up if the safety function is switched on.

Glass sunroof

General information

The glass sunroof and the sun protection are operated using the same switch.

The glass sunroof can be opened from the outside with the vehicle key and also closed with Comfort Access.

With Comfort Access: The glass sunroof can be closed from the outside via Comfort Access.

Safety information

Warning

Body parts can be jammed when operating the glass sunroof. There is a risk of injury. Make sure that the area of movement of the glass sunroof is clear during opening and closing.

Overview





Opening/closing the glass sunroof.

Functional requirements

The glass sunroof and the sun protection can be operated under the following conditions.

- ▷ Standby state is switched on.
- ▷ Drive readiness is switched on.

The vehicle key must be in the car's interior.

Lifting/closing glass sunroof



Push switch briefly upward.

- ▷ The closed glass sunroof tilts and the sun protection opens slightly.
- ▷ The opened glass sunroof closes until it is in the tilted position. The sun protection does not move.
- ▷ The tilted glass sunroof closes.

Opening/closing the glass sunroof and sun protection separately

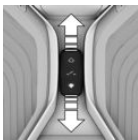

- ▷ Slide switch back to the resistance point and hold. Holding down the switch opens the sun protection. If the sun protection is already fully open, the glass sunroof opens.

- ▷ Slide switch forward to the resistance point and hold. The glass sunroof closes while the switch is being held. If the glass sunroof is already closed or in the tilted position, the sun protection closes.

- ▷ Slide the switch back past the resistance point. The sun protection opens automatically. If the sun protection is already fully open, the glass sunroof opens automatically.

Pressing the switch again stops the motion.

- ▷ Push the switch forward past the resistance point. The glass sunroof closes automatically. If the glass sunroof is already closed or in the tilted position, the sun protection closes automatically.

Pressing the switch again stops the motion.

Opening/closing the glass sunroof and sun protection together

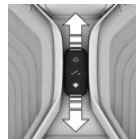

- ▷ Briefly press out the switch twice in succession toward the rear past the resistance point.

The glass sunroof and sun protection are opening together.

Pressing the switch again stops the motion.

- ▷ Briefly press out the switch twice in succession toward the front past the resistance point.

The glass sunroof and sun protection are closing together.

Pressing the switch again stops the motion.

Comfort position

In some models, the wind noises in the car's interior are lowest when the glass sunroof is not fully open. In these models, the automatic function initially only opens the glass sunroof up to this comfort position.

Pressing the switch again opens the glass sunroof fully.

Jam protection system

Concept

The jam protection prevents objects or body parts from becoming jammed between the roof and glass sunroof while the glass sunroof is closing.

General information

If a resistance or blockage is detected while the glass sunroof is closing, the closing operation is interrupted once the roof reaches the half-open position, or it is stopped when closing from the tilted position.

Closing from the open position without jam protection

In case of danger from the outside or if icing might prevent normal closing, proceed as follows:

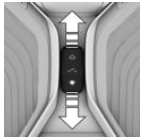

1. Close all doors.
2. Push the switch forward past the resistance point and hold.
The glass sunroof closes with limited jam protection. If the closing force exceeds a specific threshold, closing is interrupted.
3. Push the switch forward again past the resistance point and hold until the glass sunroof closes without jam protection. Make sure that the closing path is clear.

Closing from the lifted position without jam protection

In case of danger from the outside or if icing might prevent normal closing, proceed as follows:

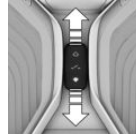

1. Close all doors.
2. Push the switch forward past the resistance point and hold.

Initializing after a power interruption

General information

After a power interruption during the opening or closing process, the glass sunroof can only be operated to a limited extent. Initializing the system can help in this case.

The system can be initialized under the following conditions:

- ▶ The vehicle is parked in a horizontal position.
- ▶ The vehicle will not be moved until the initialization is completed.
- ▶ The drive-ready state is established.
- ▶ The outside temperature is above 41 °F/5 °C.

During initialization, the glass sunroof closes without jam protection.

Make sure that the closing path is clear.

Initializing the system

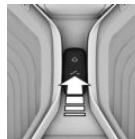

Press the switch up and hold it until the initialization is complete:

Initialization begins within 15 seconds.

- ▶ If the glass sunroof is closed, it opens then closes again.
- ▶ If the glass sunroof is open, it first closes, then opens and closes again.

Initialization is complete once the glass sunroof and sun protection have opened then closed again.

Seats, mirrors and steering wheel

Vehicle features and options

This chapter describes all standard, country-specific and optional features offered with the series. It also describes features and functions that are not necessarily available in your vehicle, e.g., due to the selected options or country versions. This also applies to safety-related functions and systems. When using these functions and systems, the applicable laws and regulations must be observed.

Sitting safely

An ideal seat position that meets the needs of the occupants can make a vital contribution to relaxed, fatigue-free driving.

In the event of an accident, the correct seat position plays an important role. Follow the information in the following chapters.

Additional information:

- ▶ Seats, refer to page [109](#).
- ▶ Safety belts, refer to page [112](#).
- ▶ Head restraints, refer to page [115](#).
- ▶ Airbags, refer to page [179](#).

Seats

Safety information

Warning

Seat setting while driving can lead to unexpected movements of the seat. Vehicle control could be lost. There is a risk of accident. Only adjust the seat on the driver's side when the vehicle is stationary.

Warning

With a backrest inclined too far to the rear, the protective effect of the safety belt can no longer be ensured. There is a risk of sliding under the safety belt in an accident. There is a risk of injury or danger to life. Adjust the seat prior to starting the trip. Adjust the backrest so that it is in the most upright position as possible and do not adjust again while driving.

Warning

There is a risk of jamming when moving the seats. There is a risk of injury or risk of damage to property. Make sure that the area of movement of the seat is clear prior to any adjustment.

Manually adjustable seats

Overview

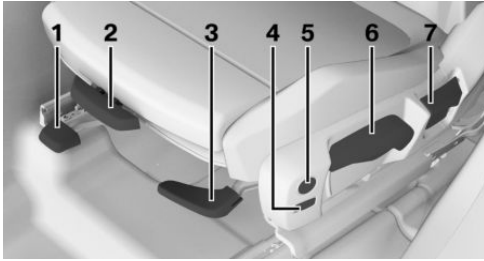

- 1 Longitudinal direction
- 2 Thigh support
- 3 Seat tilt
- 4 Backrest width
- 5 Lumbar support
- 6 Height
- 7 Backrest tilt

Longitudinal direction

Warning

Unexpected movements of the seat while driving may occur if the seat is unlocked. Vehicle control could be lost. There is a risk of accident. After adjusting, move the seat forward or back slightly, making sure the seat engages properly.



Pull the lever and slide the seat in the desired direction.

Seat tilt

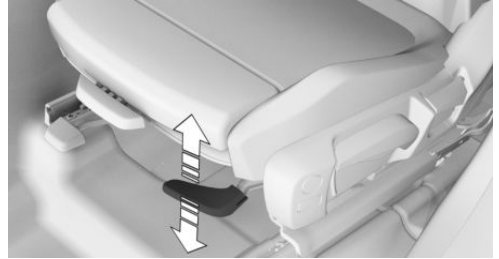

Pull the lever up or press it down as often as needed until the seat has reached the desired tilt.

Height

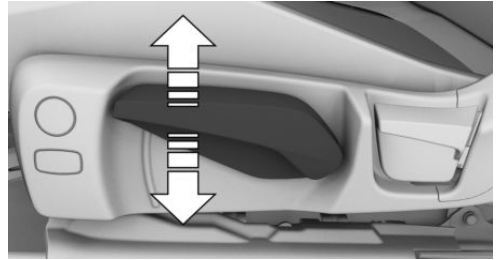

Pull the lever up or press it down as often as needed until the seat has reached the desired height.

Backrest tilt

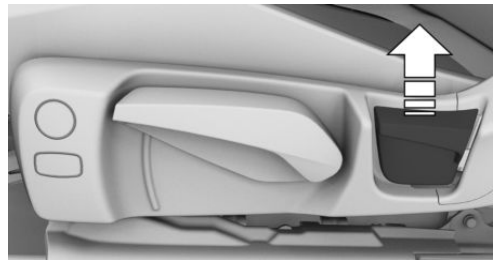

Pull the lever and apply your weight to the backrest or lift it off, as necessary.

Electrically adjustable seats

General information

The seat setting for the driver's seat is stored for the driver profile currently used. When a driver profile is selected, the stored position is called up automatically.

The current seat position can be stored using the memory function.

Overview

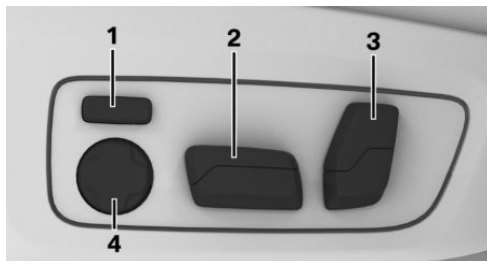

- 1 Backrest width
- 2 Forward/backward, height, seat tilt
- 3 Backrest tilt, head restraint
- 4 Lumbar support

Longitudinal direction

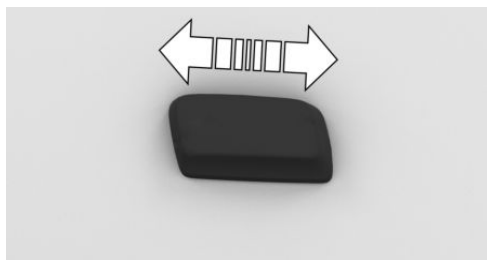

Press switch forward or backward.

Height

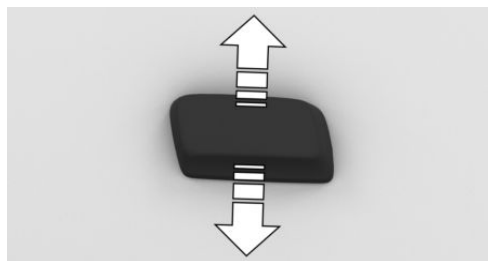

Press switch up or down.

Seat tilt

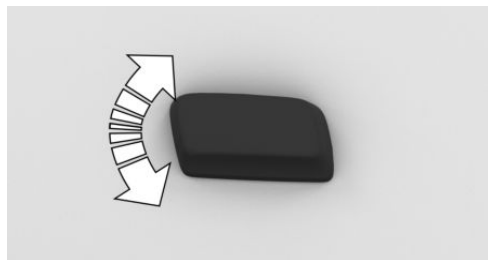

Tilt switch up or down.

Backrest tilt

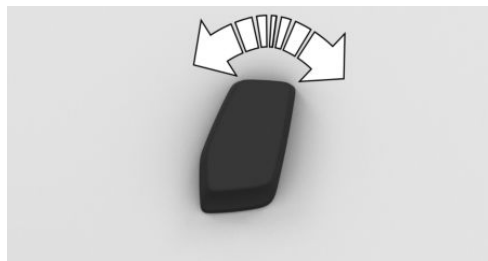

Tilt switch forward or backward.

Thigh support

Sport seat

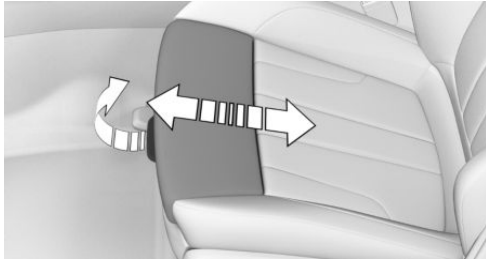

Pull the lever at the front of the seat and push the thigh support forward or back.

Lumbar support

Principle

The curvature of the seat backrest can be adjusted in a way that it supports the lumbar region of the spine. The lower back and the spine are supported for upright sitting position.

Adjusting



- ▷ Press the front/rear section of the button:
The curvature is increased/decreased.
- ▷ Press the upper/lower section of the button:
The curvature is shifted up/down.

Functional limitations

It may not be possible to adjust the lumbar support at very high and very low temperatures.

Backrest width

Principle

Adjusting the backrest width may improve lateral support when taking corners.

General information

The backrest width is changed by adjusting the side sections of the backrest.

Adjusting



- ▷ Press the front section of the button:
The backrest width decreases.
- ▷ Press the rear section of the button:
The backrest width increases.

Functional limitations

It may not be possible to adjust the backrest width at very high and very low temperatures.

Safety belts

General information

The vehicle is fitted with five safety belts to ensure occupant safety. However, they can only unfold their protective effect when adjusted correctly.

Always make sure that safety belts are being worn by the occupants before driving off. The airbags supplement the safety belts as an additional safety device. The airbags do not replace safety belts.

All belt fastening points are designed to achieve the best possible protective effect of the safety belts with proper use of the safety belts and correct seat setting. Notes on sitting safely, refer to page 109.

The two outer safety belt buckles of the rear seats are intended for the persons sitting on the left and right.

The center safety belt buckle of the rear seats is intended for the person sitting in the middle.

Safety information

Warning

Use of a safety belt to buckle more than one person will potentially defeat the ability of the safety belt to serve its protective function. There is a risk of injury or danger to life. Do not allow more than one person to wear a single safety belt. Infants and children are not allowed on an occupant's lap, but must be transported and secured in designated child restraint systems.

Warning

The protective effect of safety gear, including safety belts, can be limited or lost when safety belts are fastened incorrectly. An incorrectly fastened safety belt can cause additional injuries, for instance in the event of an accident, braking or evasive maneuvers. There is a risk of injury or danger to life. Make sure that all occupants are wearing safety belts correctly.

Warning

With a rear backrest that is not locked, the protective effect of the middle safety belt is not guaranteed. There is a risk of injury or danger to life. If you are using the middle safety belt, lock the wider rear seat backrest.

Warning

The protective effect of safety gear, including safety belts, may not be fully functional or fail in the following situations:

- ▷ The safety belts or safety belt buckles are damaged, soiled, or changed in any other way.
- ▷ Seat belt tensioners or belt retractors were modified.

Safety belts can be imperceptibly damaged in the event of an accident. There is a risk of injury or danger to life. Do not modify safety belts, safety belt buckles, seat belt tensioners, belt retractors or belt anchors and keep them clean. Have the safety belts checked after an accident at the dealer's service center or another qualified service center or repair shop.

Correct use of safety belts

- ▷ Wear the safety belt twist-free and tight to your body over your lap and shoulders.
- ▷ Wear the safety belt deep on your hips over your lap. The safety belt may not press on your stomach.
- ▷ Do not rub the safety belt against sharp edges, or guide it or jam it in across hard or fragile objects.
- ▷ Avoid thick clothing.
- ▷ Re-tighten the safety belt frequently upward around your upper body.

Buckling the safety belt

1. Guide the safety belt slowly over shoulder and hip to put it on.
2. Insert the tongue plate into the safety belt buckle. The safety belt buckle must engage audibly.

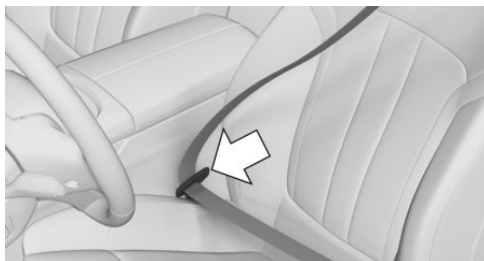

When the safety belt is fastened, the driver's and front passenger's belt straps are automatically tightened once after driving away.

Unbuckling the safety belt

1. Hold the safety belt firmly.
2. Press the red button in the safety belt buckle.
3. Guide the safety belt back into its roll-up mechanism.

Middle safety belt in the rear

Buckling the safety belt

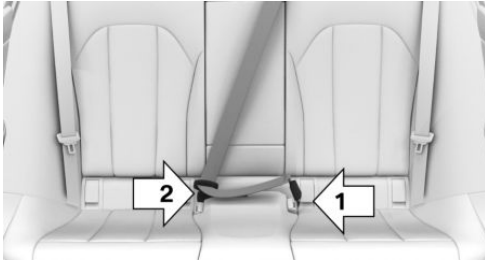

1. Pull the latch plate at the end of the belt out of the fixture on the rear shelf.
2. Insert the lower buckle tongue in the belt lock, arrow 1.
3. Insert the upper buckle tongue in the seat belt buckle, arrow 2.
The seat belt buckles must engage audibly.

Unbuckling the safety belt

1. Hold the safety belt firmly.
2. Press the red button in the belt buckle.
3. Open the belt lock, arrow 2, with the buckle tongue, arrow 1.

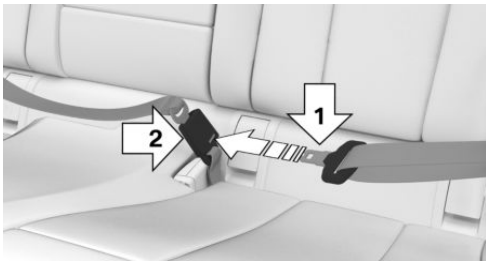

4. Guide the safety belt to the fixture on the rear shelf.

Safety belt reminder for driver's seat and front passenger seat

General information

The safety belt reminder is issued when the driver's safety belt is not buckled.

The safety belt reminder is also active when the front passenger seat belt is not buckled or objects are on the front passenger seat.

The safety belt reminder is also activated when a passenger unbuckles a safety belt during the trip.

Display in the instrument cluster



The indicator light lights up and a signal sounds. Make sure that the safety belts are positioned correctly. The safety belt reminder can also be activated if objects are placed on the front passenger seat.

Safety belt reminder for rear seats

General information





The safety belt reminder is automatically activated each time the engine starts.

The safety belt reminder is also activated when a passenger unbuckles a rear seat safety belt during the trip.

Display in the instrument cluster

The indicator light in the instrument cluster illuminates after the engine is started.

The displays may vary depending on the equipment version and country variant.

| Icon | Description |
|--|---|
|  | Green: the safety belt is buckled on the corresponding rear seat. |
|  | |
|  | Red: the safety belt is not buckled on the corresponding rear seat. |
|  | |

Safety mode

In critical driving situations, for instance during emergency braking, the front safety belts tighten automatically.

If the driving situation passes without an accident occurring, the belt tension relaxes.

If the belt tension does not loosen automatically, stop the vehicle and unbuckle the safety belt using the red button in the safety belt buckle. Fasten the safety belt before continuing on your trip.

Front head restraints

Safety information

Warning

Removal or incorrect adjustment of head restraints can cause injuries in the head and neck area. There is a risk of injury.

- ▷ Before driving, install the removed head restraints on the occupied seats.
- ▷ Adjust the head restraint so its center supports the back of the head at as close to eye level as possible.
- ▷ Adjust the distance so that the head restraint is as close as possible to the back of the head. Adjust the distance via the backrest tilt as needed.

Warning

Body parts can be jammed when moving the head restraint. There is a risk of injury. Make sure that the area of movement is clear when moving the head restraint.

Warning

Objects on the head restraint reduce the protective effect in the head and neck area. There is a risk of injury.

- ▷ Do not use seat or head restraint covers.
- ▷ Do not hang objects, for instance clothes hangers, directly on the head restraint.
- ▷ Only use accessories that have been determined to be safe for attachment to a head restraint.
- ▷ Do not use any accessories, for instance pillows, while driving.

Adjusting the height

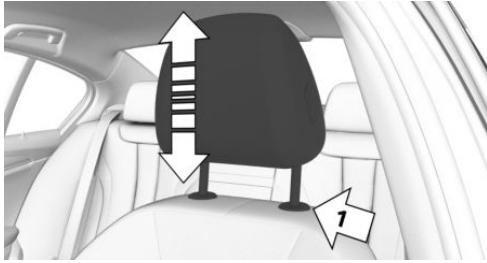

- ▶ To lower: press the button, arrow 1, and push the head restraint down.
 - ▶ To raise: push the head restraint up.
- After setting the height, make sure that the head restraint engages correctly.

Adjusting the height: M sport seat

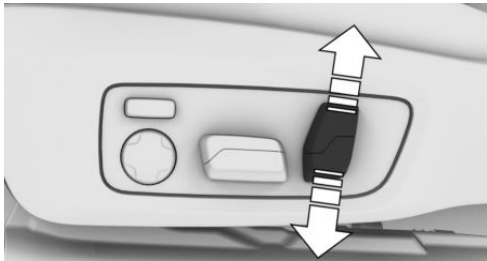

Press switch up or down.

Adjusting distance

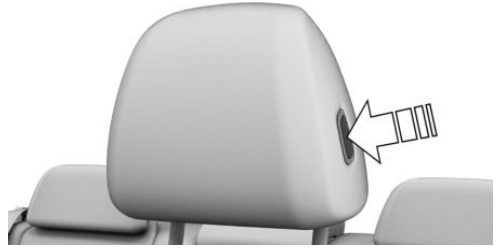

- ▶ Back: press the button and push the head restraint toward the rear.
- ▶ Forward: pull the head restraint toward the front.

After setting the distance, make sure that the head restraint engages correctly.

Adjusting the distance: M Sport seat

The distance to the back of the head is adjusted via the backrest tilt.

Adjust the distance so that the head restraint is as close as possible to the back of the head.

Removing

Only remove the head restraint if no one will be sitting in the seat in question.

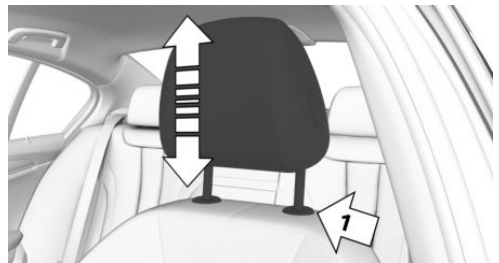

1. Raise the head restraint up against the resistance.
2. Press the button, arrow 1, and pull the head restraint out completely.

Removing: M Sport seat

The head restraints cannot be removed.

Installing

Proceed in the reverse order to install the head restraint.

Rear head restraints

Safety information

Warning

Removal or incorrect adjustment of head restraints can cause injuries in the head and neck area. There is a risk of injury.

- ▷ Before driving, install the removed head restraints on the occupied seats.
- ▷ Adjust the head restraint so its center supports the back of the head at as close to eye level as possible.
- ▷ Adjust the distance so that the head restraint is as close as possible to the back of the head. Adjust the distance via the backrest tilt as needed.

Warning

Body parts can be jammed when moving the head restraint. There is a risk of injury. Make sure that the area of movement is clear when moving the head restraint.

Warning

Objects on the head restraint reduce the protective effect in the head and neck area. There is a risk of injury.

- ▷ Do not use seat or head restraint covers.
- ▷ Do not hang objects, for instance clothes hangers, directly on the head restraint.

- ▷ Only use accessories that have been determined to be safe for attachment to a head restraint.
- ▷ Do not use any accessories, for instance pillows, while driving.

Folding down the head restraints

To improve the view to the rear, the head restraints can be folded back. Only fold the head restraint back if no one will be sitting in the corresponding seat.

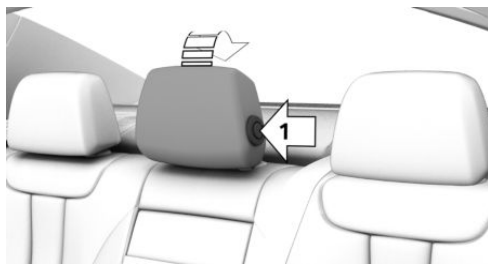

- ▷ To the rear: press the button, arrow 1, and fold the head restraint backward.
- ▷ Forward: fold the head restraint toward the front as far as it will go. Make sure that the head restraint engages correctly.

Adjusting the height



The height of the outer head restraints can be adjusted.

- ▷ To lower: press the button, arrow 1, and push the head restraint down.
- ▷ To raise: push the head restraint up.

After setting the height, make sure that the head restraint engages correctly.

Removing the outer head restraint

Only remove the head restraint if no one will be sitting in the seat in question.

1. Fold down the rear seat backrest in question.
Enlarging the cargo area, refer to page 298.
2. Raise the head restraint up against the resistance.
3. Inserting the integrated key.
Integrated key, refer to page 91.

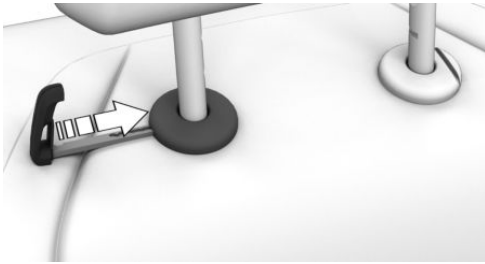

4. Press and hold the integrated key and the button at the same time, arrows 1, and pull out the head restraint completely.

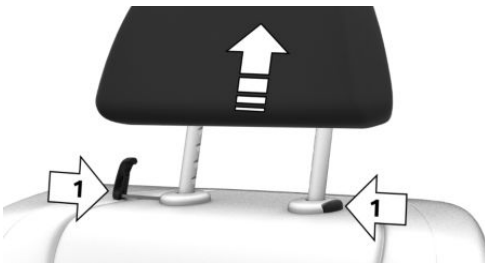

Removing the center head restraint

Only remove the head restraint if no one will be sitting in the center seat.

1. Raise the head restraint up against the resistance.
2. Press the buttons, arrow 1, and pull the head restraint out completely.

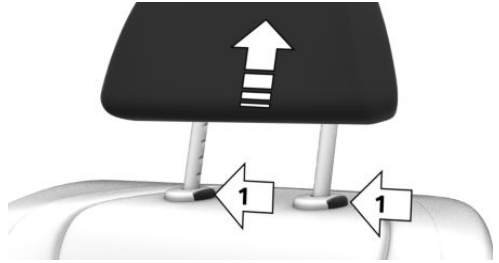
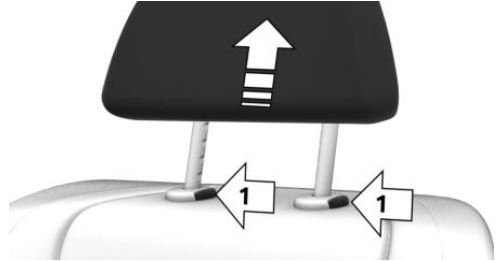

Press the buttons, arrow 1, and pull the head restraint out completely.

Installing

For mounting, insert the head restraints in the mounts and slide down until you feel the resistance.

After the installation, make sure that the head restraint engages correctly.

Exterior mirrors

General information

The mirror on the front passenger side is more curved than the driver's side mirror.

The mirror setting is stored for the driver profile currently in use. When a driver profile is selected, the stored position is called up automatically.

The current exterior mirror position can be stored using the memory function.

Safety information

Warning

Objects reflected in the mirror are closer than they appear. The distance to the road users behind could be incorrectly estimated, for instance while changing lanes. There is a risk of accident. Estimate the distance to the traffic behind by looking over your shoulder.

Overview



- 1 Adjusting
- 2 Selecting a mirror, Automatic Curb Monitor
- 3 Folding in and out

Adjusting electrically



Press the button.

The selected mirror moves along with the button movement.

Selecting a mirror



To change over to the other mirror:
Slide the switch.

Malfunction

In case of an electrical malfunction, adjust the mirror by pressing the edges of the mirror glass.

Folding in and out

NOTICE

Depending on the vehicle width, the vehicle can be damaged in car washes. There is a risk of damage to property, among other potential damage. Before washing, fold in the mirrors by hand or with the button.



Press the button.

Folding is only possible up to a speed of approx. 15 mph/20 km/h.

Folding the mirrors in and out is helpful in the following situations:

- ▷ In car washes.
- ▷ On narrow roads.

Mirrors that were folded in are folded out automatically at a speed of approx. 25 mph/40 km/h.

Automatic heating

Both exterior mirrors are automatically heated as needed and when the drive-ready state is switched on.

Automatic dimming feature

The exterior mirror on the driver's side is automatically dimmed. Photocells in the interior mirror are used to control this.

Automatic Curb Monitor

Principle

If reverse gear is engaged, the mirror glass on the front passenger side is tilted downward. This improves your view of the curb and other low-lying obstacles when parking, for instance.

Activating

1.  slide the switch to the driver's side mirror position.
2. Engage selector lever position R.

Deactivating

Slide the switch to the front passenger's side mirror position.

Interior mirror, automatic dimming feature

General information

The interior mirror is dimmed automatically.

Photocells are used for control:

- ▷ In the mirror glass.
- ▷ On the rear of the mirror.

Overview

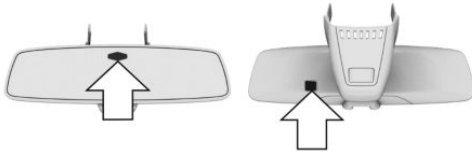

Functional requirements

- ▷ Keep the photocells clean.
- ▷ Do not cover the area between the interior mirror and the windshield.

Steering wheel

Safety information

Warning

Steering wheel adjustments while driving can lead to unexpected steering wheel movements. Vehicle control could be lost. There is a risk of accident. Adjust the steering wheel while the vehicle is stationary only.

Manual steering wheel adjustment

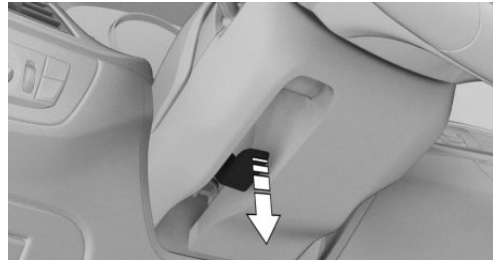

1. Fold the lever down.
2. Move the steering wheel to the preferred height and angle to suit your seat position.
3. Fold the lever back up.

Steering wheel heating

Overview



Button for steering wheel heating

Turning on/off



Press the button.

A Check Control message is displayed.

If the trip is resumed within approx. 15 minutes after an intermediate stop, the steering wheel heating turns on automatically if the function was turned on at the completion of the last trip.

Memory function

Principle

The following settings can be stored and, if necessary, retrieved using the memory function:

- ▶ Seat position.
- ▶ Exterior mirror position.
- ▶ Height of the Head-up Display.

General information

Two memory locations with different settings can be set for each driver profile.

The following settings are not stored:

- ▶ Backrest width.
- ▶ Lumbar support.

Safety information

Warning

Using the memory function while driving can lead to unexpected seat or steering wheel movements. Vehicle control could be lost. There is a risk of accident. Only retrieve the memory function when the vehicle is stationary.

Warning

There is a risk of jamming when moving the seats. There is a risk of injury or risk of damage to property. Make sure that the area of movement of the seat is clear prior to any adjustment.

Overview



The memory buttons are located on the driver's door.

Storing

1. Set the desired position.
2.  Press the button. The writing on the button lights up.
3. Press desired button 1 or 2 while the LED is lit. A signal sounds.

Calling up settings

Press the desired button 1 or 2.

The stored position is called up.

The procedure stops when a switch for setting the seat is pressed or one of the memory buttons is pressed again.

The adjustment of the seat position on the driver's side is interrupted after a short time while driving.

Seat heating

Overview

Front

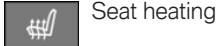
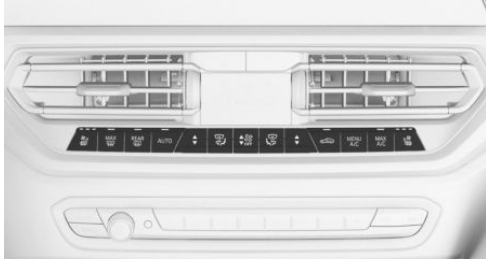

Rear

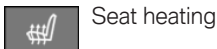

Turning on



Press the button once for each temperature level.

The maximum temperature is reached when three LEDs are lit.

If the trip is continued within approx. 15 minutes after a stop, seat heating is switched on automatically with the temperature selected last.

When ECO PRO is activated, the heating output is reduced.

Additional information:

ECO PRO, refer to page 308.

Turning off



Press and hold the button, until the LEDs turn off.

Climate control rules

Principle

Depending on the equipment, some heating and cooling functions can be automatically activated depending on the outside temperature.

General information

The outside temperature at which the functions are to be automatically activated can be set via iDrive.

Activation is performed if the outside temperature exceeds or falls below the set temperature in the first few minutes after drive-ready state has been switched on. A new alignment is carried out after the settings have been changed.

Depending on the equipment package, the following functions can be automatically activated:

- ▷ Seat heating.
- ▷ Steering wheel heating

If the trip is continued within approx. 15 minutes after a stop, the functions are activated automatically with the levels that were last selected.

Functional requirement

Drive-ready state is switched on.

Activate/deactivate

1. "CAR"
2. "Settings"
3. "Climate control"
4. If necessary, "Automate habits"
5. Select the desired function.

6. Activate the desired rule.
7. Set the level.

Transporting children safely

Vehicle features and options

This chapter describes all standard, country-specific and optional features offered with the series. It also describes features and functions that are not necessarily available in your vehicle, e.g., due to the selected options or country versions. This also applies to safety-related functions and systems. When using these functions and systems, the applicable laws and regulations must be observed.

The right place for children

Safety information

Warning

Unattended children or animals in the vehicle can cause the vehicle to move and endanger themselves and traffic, for instance due to the following actions:

- ▷ Pressing the Start/Stop button.
- ▷ Releasing the parking brake.
- ▷ Opening and closing the doors or windows.
- ▷ Engaging selector lever position N.
- ▷ Using vehicle equipment.

There is a risk of accidents or injuries. Do not leave children or animals unattended in the vehicle. Take the vehicle key with you when exiting and lock the vehicle.

Warning

A heated vehicle may result in death to persons, especially children, or animals. There is a risk of injury or danger to life. Do not leave persons, especially children, or animals unattended in the vehicle.

Warning

Exposure to intense sunlight can cause child restraint systems and their components to become very hot. Persons may sustain burn injuries when touching the hot components. There is a risk of injury. Do not expose the child restraint system to direct sunlight or cover where necessary. If necessary, let the child restraint system cool down before transporting a child. Do not leave children unattended in the vehicle.

Transport children in the rear seat

General information

Accident research shows that the safest place for children is in the rear seat.

Children younger than 13 years of age or shorter than 5 ft/150 cm should be transported in the rear seat in suitable child restraint systems designed for the age, weight and size of the child. Children 13 years of age or older must wear a safety belt as soon as a suitable child restraint system can no longer be used due to their age, weight, or size.

Safety information

Warning

The safety belt cannot be fastened correctly on children shorter than 5 ft, 150 cm without suitable additional child restraint systems. The protective effect of safety gear, including safety belts, can be limited or lost when safety belts are fastened incorrectly. An incorrectly fastened safety belt can cause additional injuries, for instance in the event of an accident, braking or evasive maneuvers. There is a risk of injury or danger to life. Secure children shorter than 5 ft, 150 cm using suitable child restraint systems.

Children on the front passenger seat

General information

Before using a child restraint system on the front passenger seat, ensure that the front, knee, and side airbags on the front passenger side are deactivated.

Additional information:

For automatic deactivation of front passenger airbags, refer to page [182](#).

Safety information

Warning

Active front passenger airbags can injure a child in a child restraint system when the airbags are activated. There is a risk of injury. Make sure that the front passenger airbags are deactivated and that the PASSENGER AIRBAG OFF indicator light lights up.

Installing child restraint systems

General information

Pay attention to the specifications and the operating and safety information of the child restraint system manufacturer when selecting, installing, and using child restraint systems.

Safety information

Warning

The protective effect of child restraint systems and their fastening systems which have been damaged or exposed to an accident can be limited or lost. A child cannot be properly restrained in the event of an accident, braking or evasive maneuvers. There is a risk of injury or danger to life.

Do not use child restraint systems which have been damaged or exposed to an accident.

If a child restraint system and its fastening system has been damaged or exposed to an accident, have these systems checked and replaced by the dealer's service center or another qualified service center or repair shop.

Warning

The stability of the child restraint system is limited or compromised with incorrect seat setting or improper installation of the child seat. There is a risk of injury or danger to life. Make sure that the child restraint system fits securely against the backrest. If possible, adjust the backrest tilt for all affected backrests and correctly adjust the seats. Make sure that seats and backrests are securely engaged or locked. If possible, adjust the height of the head restraints or remove them.

On the front passenger seat

Deactivating airbags

Warning

Active front passenger airbags can injure a child in a child restraint system when the airbags are activated. There is a risk of injury. Make sure that the front passenger airbags are deactivated and that the PASSENGER AIRBAG OFF indicator light lights up.

Before installing a child restraint system in the front passenger seat, make sure that the front, knee and side airbags on the front passenger side are deactivated.

Additional information:

For automatic deactivation of front passenger airbags, refer to page 182.

Seat position and height

After installing a child restraint system, move the front passenger seat as far back as it will go and, if possible, bring it up to the highest position. This seat position and height ensure the best possible position for the belt and offers optimal protection in the event of an accident.

If the upper attachment point of the safety belt is located in front of the belt guide of the child seat, move the front passenger seat carefully forward until the best possible belt guide position is reached.

Backrest width

Adjustable backrest width: before installing a child restraint system in the front passenger seat, open the backrest width completely. Do not change the backrest width again and do not call up a memory position.

Child seat security



The safety belts in the rear and the front passenger safety belt can be permanently locked to fasten child restraint systems.

Locking the safety belt

1. Pull out the belt strap completely.
2. Secure the child restraint system with the safety belt.
3. Allow the belt strap to be pulled in and pull it tight against the child restraint system. The safety belt is disabled.

Unlocking the safety belt

1. Unbuckle the safety belt buckle.
2. Remove the child restraint system.
3. Allow the belt strap to be pulled in completely.

LATCH child seat mountings

General information

LATCH: Lower Anchors and Tether for Children. Pay attention to the specifications and the operating and safety information from the child restraint system manufacturer when selecting, installing, and using LATCH child restraint fixing systems.

Mounts for the lower LATCH anchors

General information

The lower anchors may be used to attach the CRS to the vehicle seat up to a combined child and CRS weight of 65 lbs/30 kg when the child is restrained by the internal harnesses.

Safety information



Warning

If the LATCH child restraint fixing systems are not correctly engaged, the protective effect of the LATCH child restraint fixing system is limited. There is a risk of injury or danger to life. Make sure that the lower mountings are securely engaged and that the LATCH child restraint fixing system fits securely against the backrest.

Warning

The attachment points for child restraint systems in the vehicle are intended for attaching child restraint systems only. When other objects are mounted, the attachment points can be damaged. There is a risk of injury or risk of damage to property. Attach only child restraint systems at the corresponding attachment points.

Position

| Icon | Meaning |
|---|---|
|  | The corresponding icon shows the mounts for the lower LATCH anchors. |
|  | Seats equipped with lower mountings are marked with a pair, (2), of LATCH symbols. For vehicles equipped with a middle seat: It is not recommended to use the inner lower mountings of standard outer LATCH positions to fasten a child restraint system on the middle seat. Use the vehicle safety belt instead for the middle seat. |

Before installing LATCH child restraint fixing systems

Pull the safety belt away from the area of the child seat mountings.

Assembly of LATCH child restraint fixing systems

1. Install child restraint system, see manufacturer's information.
2. Ensure that both LATCH anchors are properly engaged.

Child restraint systems with tether strap

Safety information

Warning

If the upper retaining strap is incorrectly used for the child restraint system, the protective effect is reduced. There is a risk of injury. Make sure that the upper retaining strap does not run over sharp edges and is not twisted as it passes the upper anchor.

Warning

If the rear backrest is not locked, the protective effect of the child restraint system is limited or there is none. In certain situations, for instance braking maneuvers or in case of an accident, the rear backrest can fold forward. There is a risk of injury or danger to life. Make sure that the rear backrests are locked.

Warning

The attachment points for child restraint systems in the vehicle are intended for attaching child restraint systems only. When other objects are mounted, the attachment points can be damaged. There is a risk of injury or risk of damage to property. Attach only child restraint systems at the corresponding attachment points.

Attachment points

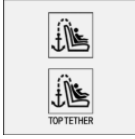
| Icon | Meaning |
|---|---|
|  | The respective icon shows the attachment point for the upper retaining strap. Seats with an upper top tether are marked with this icon. It is located on the rear seat backrest, the rear shelf or the rear seat. |

Routing the retaining strap

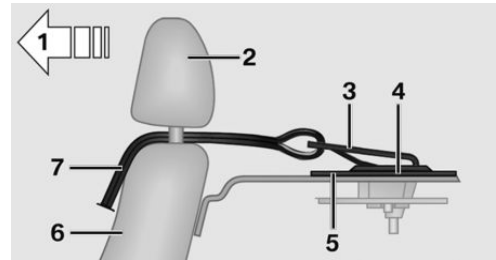

- 1 Driving direction
- 2 Head restraint
- 3 Hook for upper retaining strap
- 4 Attachment point
- 5 Rear shelf
- 6 Seat backrest
- 7 Upper retaining strap

Attaching the upper retaining strap to the attachment point

1. Open the attachment point cover.
2. Raise the head restraint.
3. Guide the upper retaining strap between the supports or along both sides of the head restraint to the attachment point.

For the middle seat, guide it over or along both sides of the head restraint to the attachment point where applicable.

4. Hook the hook of the retaining strap to the attachment point.
5. Tighten the retaining strap by pulling it down.
6. Lower and engage head restraints as needed.

This disables various functions so that they cannot be operated from the rear.

Additional information:

Safety switch, refer to page [106](#).

Locking the doors and windows in the rear



General information

In certain situations it may be advisable to secure the rear doors and windows, for instance when transporting children.

Doors



Unlock or lock the safety switch on the rear doors with the integrated key.

| Icon | Function |
|--|---------------------------------|
|  | Child safety latch is unlocked. |
|  | Child safety latch is locked. |

The door can now be opened from the outside only.

Safety switch for the rear



Press the button on the driver's door.

Driving

Vehicle features and options

This chapter describes all standard, country-specific and optional features offered with the series. It also describes features and functions that are not necessarily available in your vehicle, e.g., due to the selected options or country versions. This also applies to safety-related functions and systems. When using these functions and systems, the applicable laws and regulations must be observed.

Start/Stop button

Principle



Pressing the Start/Stop button switches drive-ready state on or off.

Steptronic transmission: the drive-ready state is switched on when you depress the brake pedal while pressing the Start/Stop button.

Pressing the Start/Stop button again switches the drive-ready state back off and standby state is switched back on.

Additional information:

- ▷ Drive-ready state, refer to page 42.
- ▷ Standby state, refer to page 42.

Driving away

1. Turn on drive readiness.
2. Apply gear position.
3. Release the parking brake.
4. Drive away.

Auto Start/Stop function

Principle

The Auto Start/Stop function helps save fuel. The system switches off the engine during a stop, for instance in traffic jam or at traffic lights. Drive-ready state remains switched on. The engine starts automatically for driving off.

Additional information:

Coasting, refer to page 311.

General information

After each engine start using the Start/Stop button, the Auto Start/Stop function is ready. The function is activated from speeds of approx. 3 mph/5 km/h.

Depending on the selected driving mode, the system is automatically activated or deactivated.

Engine stop

Functional requirements

Steptronic transmission

The engine is switched off automatically during a stop under the following conditions:

- ▷ The selector lever is in selector lever position D.
- ▷ The brake pedal remains depressed while the vehicle is stationary or the vehicle is held by Automatic Hold.
- ▷ The driver's safety belt is buckled or the driver's door is closed.

Steptronic transmission: manual engine stop

If the engine was not switched off automatically when the vehicle stopped, the engine can be switched off manually:

- ▷ Depress the brake pedal forcefully again from the current pedal position.
- ▷ Engage selector lever position P.

When all functional preconditions are fulfilled, the engine switches off.

Air conditioning system when the engine is switched off

The air flow from the air conditioning system is reduced when the engine is switched off.

Displays in the instrument cluster

General information

Instrument cluster with enhanced features:



The display in the instrument cluster indicates that the Auto Start/Stop function is ready for an automatic engine start.

Instrument cluster without enhanced features:



The display in the instrument cluster indicates that the Auto Start/Stop function is ready for an automatic engine start.



The display indicates that the conditions for an automatic engine stop have not been met.

Total time with switched-off engine

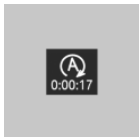

ECO PRO driving mode: depending on the vehicle equipment, the total time that the engine has been switched off using the Auto Start/Stop function is displayed

on an automatic engine stop.

The total time can be reset via the trip data.

Additional information:

ECO PRO, refer to page [308](#).

Functional limitations

The engine is not switched off automatically in the following situations:

- ▷ In case of a steep downhill grade.
- ▷ Brake not engaged strongly enough.
- ▷ The outside temperature is high and automatic climate control is running.
- ▷ The car's interior has not yet been heated or cooled to the required level.
- ▷ Where there is a risk of window condensation when the automatic climate control is switched on.
- ▷ Engine or other parts not at operating temperature.
- ▷ Engine cooling is required.
- ▷ The wheels are at a sharp angle or the steering wheel is being turned.
- ▷ Vehicle battery is heavily discharged.
- ▷ At higher elevations.
- ▷ Hood is unlocked.
- ▷ The Automatic Parking Assistant is activated.
- ▷ Stop-and-go traffic.
- ▷ Steptronic transmission: selector lever position in N or R.
- ▷ After driving in reverse.
- ▷ Use of fuel with high ethanol content.

Starting the engine

Functional requirements

Steptronic transmission

The engine starts automatically under the following preconditions:

- ▷ By releasing the brake pedal.
- ▷ When Automatic Hold is activated: step on the accelerator pedal.

Driving off

After the engine starts, accelerate as usual.

Safety mode

After the engine switches off automatically, it will not start again automatically if any one of the following conditions are met:

- ▷ The driver's safety belt is unbuckled and the driver's door is open.
- ▷ Hood was unlocked.

Some indicator lights light up for a varied length of time.

The engine can only be started via the Start/Stop button.

System limits

Even if driving off was not intended, the deactivated engine starts up automatically in the following situations:

- ▷ In case of excessive warming of the interior when air conditioning is turned on.
- ▷ In case of excessive cooling of the interior when the heating is turned on.
- ▷ In case of a risk of window condensation when the automatic climate control is turned on.
- ▷ In case of a steering operation.
- ▷ Steptronic transmission:
When changing from gear lever position D to N or R.
- ▷ Steptronic transmission:
When changing from gear lever position P to N, D, or R.
- ▷ In case of seriously discharged vehicle battery.
- ▷ When starting an oil level measurement.

Without Mild-Hybrid technology: additional functions Auto Start/Stop

Depending on the vehicle equipment and country-specific version, the vehicle features a variety of sensors for assessing the traffic situation. The Auto Start/Stop function uses this information to

adapt to various traffic situations in a proactive manner.

For instance, this applies to the following situations:

- ▷ When a situation is detected in which the stopping time is expected to be very short, the engine is not switched off automatically. A message appears on the Control Display, depending on the situation.
- ▷ When a situation is detected in which the vehicle needs to drive off immediately, the engine is started automatically.

The function may be restricted if the navigation data is invalid, outdated or not available, for example.

Activating/deactivating the system manually

Principle

The engine is not automatically switched off.

The engine is started during an automatic engine stop.

Without Mild-Hybrid technology: via button



 Press the button.

Steptronic transmission: via selector lever position

The Auto Start/Stop function is also deactivated in selector lever position M/S.

Via the Driving Dynamics Control

The Auto Start/Stop function is also deactivated in SPORT driving mode of the Driving Dynamics Control.

Without Mild-Hybrid technology: display

- ▷ LED comes on: auto Start/Stop function is deactivated.
- ▷ LED goes out: auto Start/Stop function is activated.

Switching off the vehicle during an automatic engine stop

General information

During an automatic engine stop, the vehicle can be switched off permanently, for instance when leaving it.

Steptronic transmission

1. Press the Start/Stop button.
 - ▷ Drive-ready state is switched off.
 - ▷ Standby state is switched on.
 - ▷ Selector lever position P is engaged automatically.
2. Set the parking brake.

Automatic deactivation

General information

In certain situations, the Auto Start/Stop function is deactivated automatically for safety reasons, for instance if no driver is detected.

Malfunction

The Auto Start/Stop function no longer switches off the engine automatically. A Check Control message is displayed. It is possible to continue driving. Have the system checked by a dealer's service center or another qualified service center or repair shop.

Driving Dynamics Control

Principle

The Driving Dynamics Control influences the driving dynamics properties of the vehicle.

The vehicle can be adjusted depending on the situation using various driving modes.

General information

The following systems are affected, for instance:

- ▷ Engine characteristics.
- ▷ Steptronic transmission.
- ▷ Adaptive M chassis.
- ▷ Steering.
- ▷ Display in the instrument cluster.
- ▷ Cruise control.

Overview



Displays in the instrument cluster



The selected driving mode is displayed in the instrument cluster.

Driving modes



Buttons in the vehicle

| Button | Driving mode | Configuration |
|----------|--------------|---------------|
| SPORT | SPORT | INDIVIDUAL |
| SPORT | SPORT PLUS | |
| COMFORT | COMFORT | |
| ECO PRO | ECO PRO | INDIVIDUAL |
| ADAPTIVE | ADAPTIVE | |

When drive-ready state is switched on, the COMFORT driving mode is selected automatically.

Driving modes in detail

COMFORT

Principle

The COMFORT driving mode is a balanced setting between sporty and consumption optimized driving.

Turning on



Press the button repeatedly until COMFORT is displayed in the instrument cluster.

SPORT

Principle

The SPORT driving mode is a dynamic setting for more agility with an optimized suspension.

Turning on



Press the button repeatedly until SPORT is displayed in the instrument cluster.

SPORT INDIVIDUAL

Principle

In the SPORT INDIVIDUAL driving mode, individual settings can be adjusted to support driving dynamics properties.

Configuration

- "CAR"
- "Settings"
- "Driving mode"
- "SPORT INDIVIDUAL"
- Select the desired setting.

Reset SPORT INDIVIDUAL to the standard settings:

"Reset to SPORT STANDARD".

SPORT PLUS

Principle

The SPORT PLUS driving mode is a dynamic setting for maximum agility with an adjusted drive.

Turning on



Press the button repeatedly until SPORT PLUS is displayed in the instrument cluster.

ECO PRO

Concept

In ECO PRO drive mode, consumption is optimized.

Turning on

 Press the button repeatedly until ECO PRO is displayed in the instrument cluster.

ECO PRO INDIVIDUAL

Principle

In the ECO PRO INDIVIDUAL driving mode, individual settings can be adjusted to support an economical driving style.

The engine control and comfort features, for instance the climate control output, are adjusted.

Configuration

1. "CAR"
2. "Settings"
3. "Driving mode"
4. "ECO PRO INDIVIDUAL"
5. Select the desired setting.

Reset ECO PRO INDIVIDUAL to the standard settings:

"Reset to ECO PRO STANDARD".

ADAPTIVE

Principle

The ADAPTIVE driving mode is a balanced driving mode that automatically adapts to the driving situation and driving style.

If the navigation system is active, upcoming road sections are considered.

Switching on

 Press the button. ADAPTIVE is displayed in the instrument cluster.

INDIVIDUAL configuration

General information

The last individual configuration is activated directly when the driving mode is called up again.

Activating configuration of the drive mode

Press the button for the desired drive mode several times.

Parking brake

Principle

The parking brake is used to prevent the vehicle from rolling when it is parked.

Safety information

Warning

An unsecured vehicle can begin to move and possibly roll away. There is a risk of accident. Before exiting, secure the vehicle against rolling.

In order to ensure that the vehicle is secured against rolling away, follow the following:

- ▷ Set the parking brake.
- ▷ On uphill grades or on a downhill slope, turn the front wheels in the direction of the curb.
- ▷ On uphill grades or on a downhill slope, also secure the vehicle, for instance with a wheel chock.

Warning

Unattended children or animals in the vehicle can cause the vehicle to move and endanger themselves and traffic, for instance due to the following actions:

- ▷ Pressing the Start/Stop button.
- ▷ Releasing the parking brake.
- ▷ Opening and closing the doors or windows.
- ▷ Engaging selector lever position N.
- ▷ Using vehicle equipment.

There is a risk of accidents or injuries. Do not leave children or animals unattended in the vehicle. Take the vehicle key with you when exiting and lock the vehicle.

Overview



 Parking brake

Setting

With a stationary vehicle

 Pull the switch.
The LED lights up.

 The indicator light in the instrument cluster illuminates red. The parking brake is set.

While driving

General information

To use as emergency brake while driving.

 Pull the switch and hold it. The vehicle brakes hard while the switch is being pulled.

 The indicator light in the instrument cluster illuminates red, a signal sounds, and the brake lights illuminate.

A Check Control message is displayed.

The parking brake is engaged when the vehicle is stationary.

With Emergency Stop Assistant

 Pull the switch briefly to activate the emergency stop function.

Additional information:

Emergency Stop Assistant, refer to page [206](#).

Releasing

Releasing manually

1. Turn on drive readiness.
2.  Steptronic transmission: press the switch while the brake is pressed or selector lever position P is set.
The LED and indicator light turn off.
The parking brake is released.

Automatic release

The parking brake is released automatically when you drive away.

The LED and indicator light turn off.

Steptronic transmission: Automatic Hold

Principle

Automatic Hold assists the driver by automatically setting and releasing the brake, such as when moving in stop-and-go traffic.

The vehicle is automatically held in place when it is stationary.

On uphill grades the system prevents the vehicle from rolling back when driving off.

General information

Under the following conditions, the parking brake is automatically engaged:

- ▷ Drive-ready state is switched off.
- ▷ The driver's door is opened while the vehicle is stationary.
- ▷ The moving vehicle is brought to a standstill using the parking brake.

Safety information

Warning

An unsecured vehicle can begin to move and possibly roll away. There is a risk of accident. Before exiting, secure the vehicle against rolling.

In order to ensure that the vehicle is secured against rolling away, follow the following:

- ▷ Set the parking brake.
- ▷ On uphill grades or on a downhill slope, turn the front wheels in the direction of the curb.
- ▷ On uphill grades or on a downhill slope, also secure the vehicle, for instance with a wheel chock.

Warning

Unattended children or animals in the vehicle can cause the vehicle to move and endanger themselves and traffic, for instance due to the following actions:

- ▷ Pressing the Start/Stop button.
- ▷ Releasing the parking brake.
- ▷ Opening and closing the doors or windows.

- ▷ Engaging selector lever position N.
- ▷ Using vehicle equipment.

There is a risk of accidents or injuries. Do not leave children or animals unattended in the vehicle. Take the vehicle key with you when exiting and lock the vehicle.

NOTICE

If the vehicle is stationary, Automatic Hold engages the parking brake and prevents the vehicle from rolling in a car wash. There is a risk of damage to property, among other potential damage. Deactivate Automatic Hold prior to entering the car wash.

Overview



 Automatic Hold

Establishing operational readiness of Automatic Hold

1. Turn on drive readiness.
2.  Press the button.

The LED lights up.

 The indicator light lights up green.
Automatic Hold is functional.

After every vehicle restart, the last selected setting is active.

Automatic Hold holding the vehicle

Operational readiness is established and the driver's door is closed.



After the brake is applied, the vehicle is kept from rolling as soon as the indicator light illuminates green.

Driving off

Press the accelerator pedal to drive off.

The brake is released automatically and the indicator light of the parking brake is no longer illuminated.

Activating the parking brake automatically

The parking brake is automatically set if drive-ready state is switched off while the vehicle is being held by Automatic Hold or if the vehicle is exited.



The indicator light changes from green to red.

The parking brake is not set automatically, if the drive-ready state is switched off, while the vehicle is coasting to a halt. Automatic Hold is deactivated.

Switching operational readiness off



Press the button.

The LED goes out.



The indicator light goes out.

Automatic Hold is switched off.

If the vehicle is being held by Automatic Hold, press additionally on the brake pedal, when switching off.

Malfunction

If the parking brake fails or in case of a fault, secure the vehicle against rolling before exiting.

A Check Control message is displayed.

Secure the vehicle against rolling away, for instance with a wheel chock, after exiting the vehicle.

After a power interruption

To reestablish parking brake functionality after a power interruption:

1. Turn on standby state.
2.  Pull the switch while stepping on the brake pedal or selector lever position P is set and then push.

This process may take a few seconds. Some mechanical sounds associated with this process are normal.



The indicator light is no longer illuminated as soon as the parking brake is ready for operation again.

Turn signal

Turn signal in exterior mirror

When driving and during operation of the turn signals or hazard warning system, do not fold in the exterior mirrors, so that the signal lights on the exterior mirror are easy to see.

Blinking

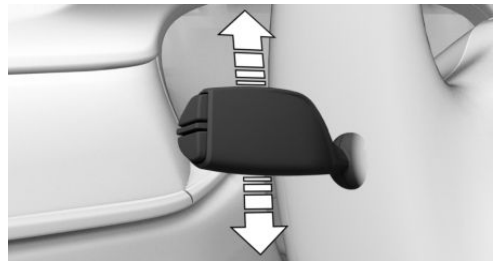

Press the lever past the resistance point.

Triple turn signal activation

Lightly tap the lever up or down.

The triple turn signal duration can be adjusted.

1. "CAR"
2. "Settings"
3. "Exterior lighting"
4. "One-touch turn signal"
5. Select the desired setting.

Brief blinking

Press the lever to the resistance point and hold it there for as long as you want the turn signal to flash.

High beams, headlight flasher

Press the lever forward or pull it backward.

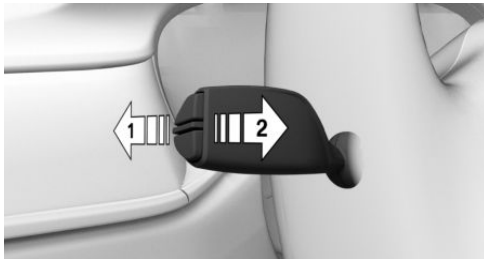

- ▷ High beams on, arrow 1.
The high beams light up when the low beams are switched on.
- ▷ High beams off/headlight flasher, arrow 2.

Window wiper system

General information

Do not use the wipers if the windshield is dry, as this may damage the wiper blades or cause them to become worn more quickly.

Safety information

⚠ Warning

If the wipers start moving in the folded away state, body parts can be jammed or damage may occur to parts of the vehicle. There is a risk of injury or risk of damage to property. Make sure that the vehicle is switched off when the wipers are in the folded away state and the wipers are folded in when switching on.

⚠ NOTICE

If the wipers are frozen to the windshield, the wiper blades can be torn off and the wiper motor can overheat when switching on. There is a risk of damage to property, among other potential damage. Defrost the windshield prior to switching the wipers on.

Turn on window wiper system

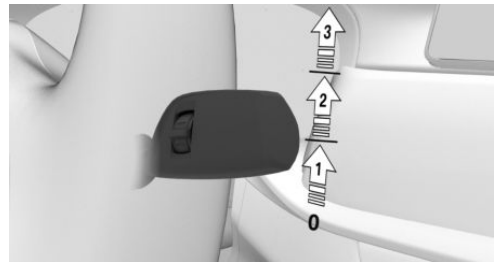

Press the lever up until the desired position is reached.

- ▷ Resting position of the wipers, position 0.
- ▷ Rain sensor, position 1.
- ▷ Normal wiper speed, position 2.
- ▷ Fast wiper speed, position 3.

When the journey is interrupted with the window wiper system turned on: when the journey continues, the wipers resume at their previous speed.

Turn off the window wiper system and flick wipe

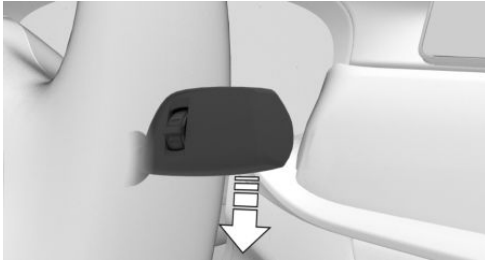

Press the lever down.

- ▶ Turn off: press the lever down until it reaches the 0 position.
- ▶ Flick wipe: press the lever down from the 0 position.
The lever automatically returns to its 0 position when released.

Rain sensor

Principle

The rain sensor automatically controls the time between wipes depending on the intensity of the rainfall.

General information

The sensor is located on the windshield, directly in front of the interior mirror.

Safety information

NOTICE

If the rain sensor is activated, the wipers can accidentally start moving in vehicle washes. There is a risk of damage to property, among other potential damage. Deactivate the rain sensor in vehicle washes.

Activate rain sensor

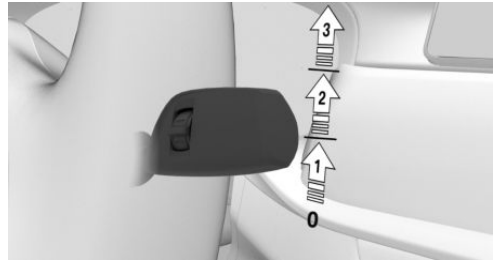

Press the lever up once from its 0 position, arrow 1.

Wiping operation is started.

The LED in the wiper lever is illuminated.

In frosty conditions, wiping operation may not start.

Deactivate rain sensor

Press the lever back into the 0 position.

Adjusting the rain sensor sensitivity

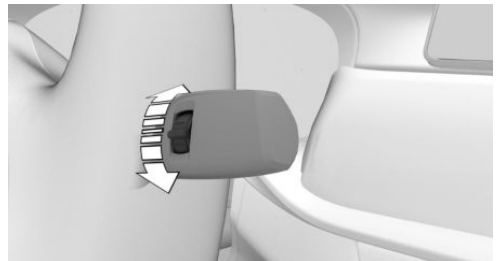

Turn the thumbwheel to adjust the sensitivity of the rain sensor.

Upward: high rain sensor sensitivity.

Downward: low rain sensor sensitivity.

Windshield washer system

Safety information

Warning

The washer fluid can freeze onto the window at low temperatures and obstruct the view. There is a risk of accident. Only use the washer systems, if the washer fluid cannot freeze. Use washer fluid with antifreeze, if needed.

NOTICE

When the washer fluid reservoir is empty, the wash pump cannot work as intended. There is a risk of damage to property, among other potential damage. Do not use the washer system when the washer fluid reservoir is empty.

Cleaning the windshield



Pull the lever.

The washer fluid is sprayed onto the windshield directly in front of the wiper blade when the wiper moves upward.

Fold-away position of the wipers

Principle

In the fold-out position, the wipers can be folded out from the windshield, which is important, for instance, when changing the wiper blades or for folding away under frosty conditions.

Safety information

Warning

If the wipers start moving in the folded away state, body parts can be jammed or damage may occur to parts of the vehicle. There is a risk of injury or risk of damage to property. Make sure that the vehicle is switched off when the wipers are in the folded away state and the wipers are folded in when switching on.

NOTICE

If the wipers are frozen to the windshield, the wiper blades can be torn off and the wiper motor can overheat when switching on. There is a risk of damage to property, among other potential damage. Defrost the windshield prior to switching the wipers on.

Folding out the wipers

1. Turn on standby state.
2. Press and hold the wiper lever down, until the wipers stop in a close to vertical position.

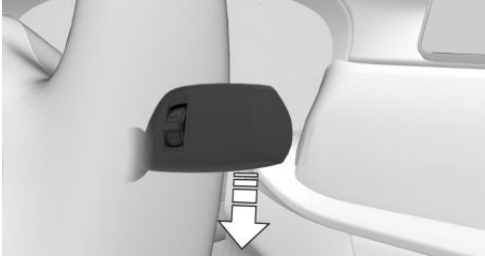

3. Fold the wipers all the way out from the wind-shield.



Folding down the wipers

1. Fold the wipers back down onto the wind-shield.
2. Switch on standby state and press and hold the wiper lever down again.
Wipers return to their resting position and are ready again for operation.

Steptronic transmission

Principle

The Steptronic transmission combines the functions of an automatic transmission with the possibility of manual shifting, if needed.

Safety information

Warning

An unsecured vehicle can begin to move and possibly roll away. There is a risk of accident. Before exiting, secure the vehicle against rolling, for instance with the parking brake.

Selector lever positions

Gear position D

Selector lever position for normal driving. All gears for forward travel are activated automatically.

R is reverse

Engage selector lever position R only when the vehicle is stationary.

Neutral N

The vehicle may be pushed or roll without power, for instance in vehicle washes in selector lever position N.

Parking position P

General information

Selector lever position, for instance for parking the vehicle. The transmission blocks the individual wheels in selector lever position P.

Engage selector lever position P only when the vehicle is stationary.

P is engaged automatically

Selector lever position P is engaged automatically in situations such as the following:

- After the drive-ready state is switched off and selector lever position R, D or M/S is engaged.
- After the standby state has been turned off when selector lever position N is engaged.
- If the driver's safety belt is unbuckled, the driver's door is opened, and the brake pedal is not pressed while the vehicle is stationary and selector lever position D, M/S or R is engaged.

Before exiting the vehicle, make sure that selector lever position P is set. Otherwise, the vehicle may begin to move. Also set parking brake.

Additional information:

Parking brake, refer to page 135.

Engaging selector lever positions

General information

To prevent the vehicle from creeping after you select a gear position, maintain pressure on the brake pedal until you are ready to start.

Functional requirements

Only when the drive-ready state is switched on and the brake pedal is depressed is it possible to change from selector lever position P to another selector lever position.

The selection lever position P cannot be changed until all technical requirements are met.

Engaging selector lever position D, N, R

A selector lever lock prevents the following faulty operation:

- Unintentional shifting into selector lever position R.
- Unintentional shifting from selector lever position P into another selector lever position.

1. Fasten driver's safety belt.
2. Press and hold the button to release the selector lever lock.

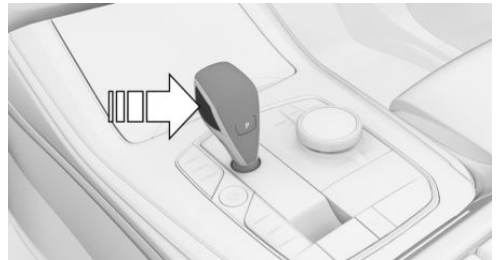

3. Push the selector lever in the desired direction, past a resistance point, if needed. The selector lever automatically returns to the center position when released.

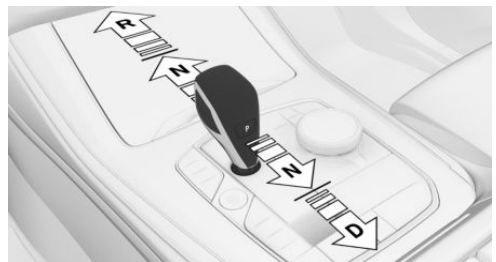

Engaging selector lever position P



Press button P.

Rolling or pushing the vehicle

General information

In some situations, the vehicle is to roll without its own power for a short distance, for instance in a car wash, or be pushed.

Engaging selector lever position N

NOTICE

Selector lever position P is automatically engaged when standby state is switched off. There is a risk of damage to property, among other potential damage. Do not switch standby state off in car washes.

1. Switch on drive-ready state while pressing on the brake pedal.
2. If necessary, release the parking brake.
3. If necessary, switch off Automatic Hold. Automatic Hold, refer to page 136.
4. Depress the brake pedal.
5. Touch the selector lever lock and engage selector lever position N.
6. Switch off drive-ready state.

In this way, standby state remains switched on, and a Check Control message is displayed.

The vehicle can roll.

Selector lever position P is engaged automatically after approximately 35 minutes.

If there is a malfunction, you may not be able to change the selector lever position.

Electronically unlock the transmission lock, if needed.

Kickdown

Kickdown is used to achieve maximum driving performance.

Step on the accelerator pedal beyond the resistance point at the full throttle position.

Sport program M/S

Principle

The shifting points and shifting times in the Sport program are designed for sportier handling. The transmission, for instance shifts up later and the shifting times are shorter.

Activating the Sport program

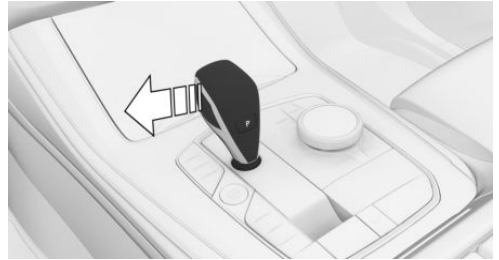

Press the selector lever to the left from selector lever position D.

The engaged gear is displayed in the instrument cluster, for instance S1.

The sport program of the transmission is activated.

Ending the Sport program

Press the selector lever to the right.

D is displayed in the instrument cluster.

Manual mode M/S

Principle

Manual gear-shifting is possible in manual mode.

Activating manual mode

1. Press the selector lever to the left from selector lever position D, arrow 1.

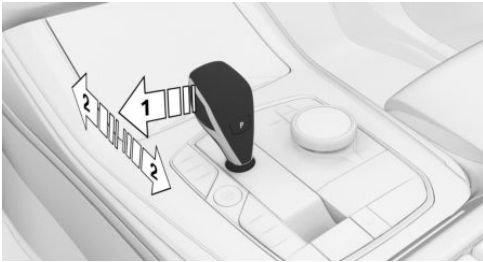

2. Press the selector lever forward or pull it backward, arrows 2.

Manual mode becomes active and the gear is changed.

The engaged gear is displayed in the instrument cluster, for instance M1.

Shifting

- ▷ To shift down: press the selector lever forward.
- ▷ To shift up: pull the selector lever rearwards.

The transmission continues shifting automatically in certain situations, for instance when RPM limits are reached.

Steptronic Sport transmission: prevent automatic upshifting in M/S manual mode

Depending on the motorization: if driving mode SPORT is selected, the Steptronic Sport transmission does not automatically upshift in M/S manual mode once the maximum speed is reached.

In addition, there is no downshifting for kick-down.

Additional information:

SPORT, refer to page [134](#).

Ending the manual mode

Press the selector lever to the right.

D is displayed in the instrument cluster.

Shift paddles

Principle

The shift paddles on the steering wheel allow you to shift gears quickly while keeping both hands on the steering wheel.

General information

Shifting

The vehicle only shifts at suitable RPM and road speeds.

Short-term manual mode

In selector lever position D, actuating a shift paddle switches into manual mode temporarily.

After conservative driving in manual mode without acceleration or shifting via the shift paddles for a certain amount of time, the transmission switches back to automatic mode.

It is possible to switch into automatic mode:

- ▷ Keep the right shift paddle pulled until D is displayed in the instrument cluster.
- ▷ In addition to the pulled right shift paddle, pull the left shift paddle.

Continuous manual mode

In selector lever position S, actuating a shift paddle switches into manual mode permanently.

With the transmission version it is possible to switch into automatic mode:

- ▷ Keep the right shift paddle pulled until S is displayed in the instrument cluster.
- ▷ In addition to the pulled right shift paddle, pull the left shift paddle.

Steptronic Sport transmission

With the appropriate transmission version, the lowest possible gear can be selected by simultaneously activating kickdown and operating the

left shift paddles. This is not possible in short-term manual mode.

Shifting



- ▷ Shifting up: pull the right shift paddle.
- ▷ Shifting down: pull left shift paddle.
- ▷ Downshifting to the lowest possible gear: keep the left shift paddle pulled.

The selected gear is briefly displayed in the instrument cluster, followed by the current gear.

Displays in the instrument cluster

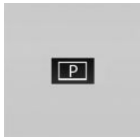

The selector lever position is displayed, for example P.

Electronic unlocking of the transmission lock

General information

Electronically unlock the transmission lock to maneuver vehicle from a hazardous area.

Before unlocking the transmission lock, set the parking brake to prevent the vehicle from rolling away.

In vehicles with Mild-Hybrid technology and corresponding vehicle battery, the action steps for unlocking the transmission vary.

Additional information:

Vehicle battery, refer to page [360](#).

Without Mild-Hybrid technology: engage selector lever position N

Unlocking is possible, if the starter can crank the engine.

1. Press and hold down brake pedal.
2. Press the Start/Stop button. The starter must audibly start. Hold the Start/Stop button pressed.
3. With your free hand, press the button on the selector lever, arrow 1, and press the selector lever into selector lever position N and hold, arrow N, until selector lever position N is displayed in the instrument cluster.

A Check Control message is displayed.



4. Release Start/Stop button and selector lever.
5. Release brake, as soon as the starter stops.
6. Maneuver the vehicle from the hazardous area and secure it against rolling away.

Additional information:

Tow-starting/towing, refer to page [368](#).

With Mild-Hybrid technology: engage selector lever position N

1. Press and hold down brake pedal.
2. Press and hold the Start/Stop button.
3. With your free hand, press the button on the selector lever, arrow 1, and press the selector lever into selector lever position N and hold, arrow N, until selector lever position N is displayed in the instrument cluster.

A Check Control message is displayed.



4. Release Start/Stop button and selector lever.
5. Release the brake.
6. Maneuver the vehicle from the danger area and secure it against moving on its own.

Additional information:

Tow-starting/towing, refer to page [368](#).

Launch Control

Principle

Launch Control enables optimum acceleration on roads with good traction under dry surrounding conditions.

General information

The use of Launch Control causes premature component wear since this function represents a very heavy load for the vehicle.

Do not use Launch Control during the break-in.

Do not steer the steering wheel when driving off with Launch Control.

Additional information:

Breaking-in period, refer to page [302](#).

Functional requirement

Launch Control is available when the engine is at operating temperature. The engine is at operating temperature after an uninterrupted trip of at least 6 miles/10 km.

Start with launch control

1. Turn on drive readiness.

2.  Press the button.

TRACTION is displayed in the instrument cluster and the indicator light for DSC OFF lights up.

3. Engage selector lever position S.
4. With the left foot, forcefully press down on the brake.
5. Press and hold down the accelerator pedal beyond the resistance point at the full throttle position, kickdown.

A destination flag is displayed in the instrument cluster.

6. The starting engine speed adjusts. Wait briefly until the engine speed is constant. Keep the accelerator pedal in this position.
7. Release the brake within 3 seconds after the destination flag illuminates.

The vehicle accelerates.

Upshifting occurs automatically as long as the destination flag is displayed and the accelerator pedal is not released.

Repeated use during a trip

After Launch Control has been used, the transmission must cool down for approx. 5 minutes before Launch Control can be used again.

Launch Control adjusts to the surrounding conditions, when used again.

After using Launch Control

To increase driving stability, activate DSC Dynamic Stability Control again as soon as possible.

System limits

An experienced driver may be able to achieve better acceleration values in DSC OFF mode.

Displays

Vehicle features and options

This chapter describes all standard, country-specific and optional features offered with the series. It also describes features and functions that are not necessarily available in your vehicle, e.g., due to the selected options or country versions. This also applies to safety-related functions and systems. When using these functions and systems, the applicable laws and regulations must be observed.

Instrument cluster

General information

Depending on the vehicle equipment, it may be possible to deactivate the display change in the instrument cluster via iDrive.

Some of the displays in the instrument cluster may differ from the illustrations in the Owner's Manual.

Instrument cluster with enhanced features: Overview

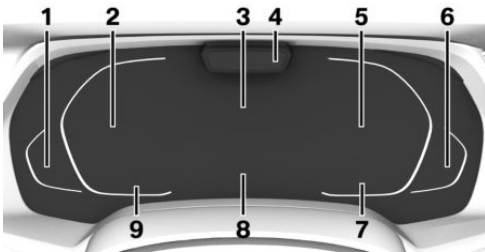

- 1 Fuel gauge [159](#)
Range [162](#)
- 2 Speedometer
- 3 Central display area [149](#)

Navigation display

- 4 Depending on the equipment: Driver Attention Camera
- 5 Tachometer [159](#)
Selection lists [165](#)
Widgets [150](#)
Trip odometer, see Trip data [166](#)
ECO PRO displays [308](#)
Power gauge [160](#)
Status, Driving Dynamics Control [133](#)
Transmission display [142](#)
- 6 Engine temperature [161](#)
- 7 Outside temperature [162](#)
- 8 Check Control [153](#)
- 9 Speed Limit Assistant [228](#)
Speed Limit Info [164](#)
Time [63](#)

Instrument cluster without enhanced features: Overview

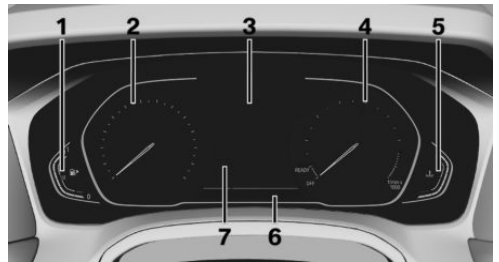

- 1 Fuel gauge [159](#)
- 2 Speedometer
- 3 Check Control [153](#)
Widgets [151](#)
Service notifications [163](#)
Navigation display

- Shift lights 160
- Range 162
- 4 Tachometer 159
 - Power gauge 160
- 5 Engine temperature 161
- 6 Outside temperature 162
 - Transmission display
 - Status, Driving Dynamics Control 133
 - Time 63
- 7 Speed Limit Info 164

Central display area

Depending on the equipment and configuration, the following is displayed in the central display area of the instrument cluster:

- ▶ Navigation displays such as the map view or, if destination guidance is active, a route preview with route guidance information.
- ▶ Displays showing service notifications.
- ▶ Assisted Driving View. Information about the assist systems is displayed in an animated surrounding area of the vehicle.

Some displays in the central display area can be configured individually.

The displays may vary depending on the equipment version and country variant.

Driving mode view

Principle

Depending on the equipment, if the driving mode view is activated, the displays in the instrument cluster will adapt to the respective driving mode when a program is changed via the Driving Dynamics Control.

Activate/deactivate

1. "CAR"
2. "Settings"

3. "Displays"
4. "Driving mode view"

Settings

Individual displays in the instrument cluster can be configured individually.

1. "CAR"
2. "Settings"
3. "Displays"
4. "Instrument panel"
5. Select the desired setting.

Assisted Driving View

Principle

Depending on the equipment, information about the driver assistance systems is displayed in an animated surrounding area of the vehicle when driver assistance is active.

General information

Depending on the settings, Assisted Driving View can be displayed permanently or temporarily with active driving assistance in the instrument cluster.

Safety information

Warning

The system cannot serve as a substitute for the driver's personal judgment in assessing visibility and traffic situation. There is a risk of accident. Adjust driving style to traffic conditions. Watch traffic closely and actively intervene where appropriate.

Settings

Permanent display

1. "CAR"
2. "Settings"
3. "Displays"
4. "Instrument panel"
5. "Central display area"
6. "Assisted Driving View"

Temporary display

1. "CAR"
2. "Settings"
3. "Displays"
4. "Instrument panel"
5. "Display Assisted Driving View when Driver Assistance is active"

Display

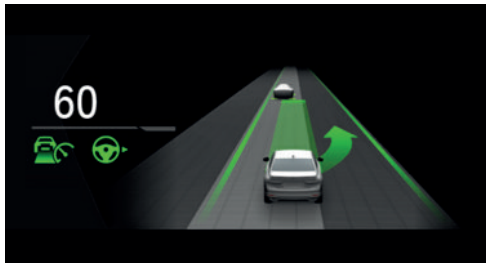

Example: the indicator/warning lights for the Active Cruise Control with Stop & Go function ACC and the Lane Change Assistant indicate a lane change to the next lane. At the same time, the lane change to the next lane is shown with animation in the Assisted Driving View.

System limits

The system's detection capability is limited. The system may indicate something wrong.

Only objects that are detected by the system are taken into account.

Additional information:

- ▷ Cameras, refer to page 37.
- ▷ Radar sensors, refer to page 38.

Instrument cluster with extended features: Widgets

Principle

Displays for specific functions can be displayed in the instrument cluster.

The following displays can be selected:

- ▷ Current entertainment source, e.g., radio.
- ▷ Torque and power.
- ▷ G-Meter.
- ▷ Trip data.
- ▷ Efficiency display.

Selecting

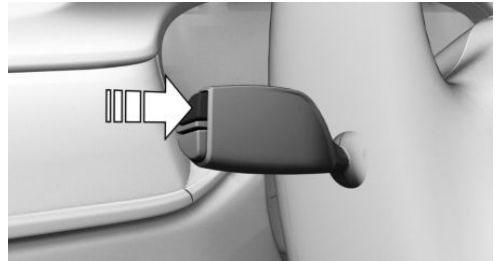

Continue to press the button on the turn signal lever until the desired widget is selected.

Display



G-meter

The G-meter indicates the forces that are applied in longitudinal and transverse direction on the vehicle occupants while driving.

Efficiency display

Principle

Information about driving style and consumption can be displayed in the form of a consumption display as a widget in the instrument cluster, for example.

General information

Depending on the activated driving mode, different information will be displayed:

| Driving mode | Display |
|--------------|---|
| COMFORT | Average consumption. |
| SPORT | Current consumption. Energy recovery. |
| ECO PRO | ECO PRO bonus range. Distance traveled in Coasting mode. Current consumption. |

Average fuel consumption

The average consumption indicates the fuel consumption when driving a specific route.

Current consumption

The current consumption displays the current consumption of fuel. Check whether you are currently driving in an efficient and environmentally-friendly manner.

Energy recovery

During energy recovery, the kinetic energy of the vehicle is converted into electric energy in coasting overrun mode. The vehicle battery is partially charged and fuel consumption can be reduced.

ECO PRO bonus range

In the ECO PRO driving mode, the yielded extension of the range as a result of fuel-efficient driving is displayed as ECO PRO bonus range.

Instrument cluster without enhanced features: Widgets

Principle

Displays for specific functions can be displayed in the instrument cluster.

- ▷ Distance traveled.
- ▷ Consumption display.
- ▷ Current fuel consumption and average fuel consumption.
- ▷ Digital speed.
- ▷ Navigation data.

When destination guidance is activated in the navigation system.

- ▷ Driver assistance systems.
- ▷ Compass display for the driving direction.
- ▷ Current entertainment source, e.g., radio.

Selecting

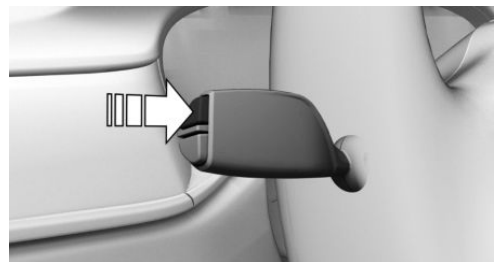

Continue to press the button on the turn signal lever until the desired widget is selected.

Configuring widgets

Some widgets can be configured individually.

1. "CAR"
2. "Settings"
3. "Displays"
4. "Instrument panel"
5. "Configure widgets"
6. Select the desired setting.

Information in detail

Distance traveled

The widget for the distance traveled shows the total distance and traveled distance depending on the setting for the display of the trip data.

Consumption display

Principle

During energy recovery, the kinetic energy of the vehicle is converted into electric energy in coasting overrun mode. The vehicle battery is partially charged and fuel consumption can be reduced.

The current consumption displays the current consumption of fuel. Check whether you are currently driving in an efficient and environmentally-friendly manner.

General information

Energy recovery and current consumption can be displayed as bar displays.

Display

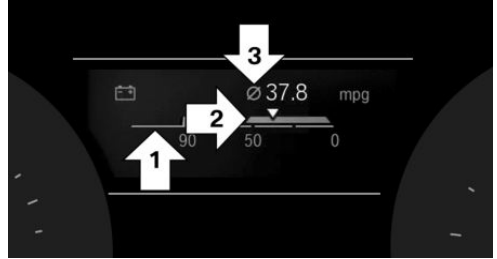

- ▷ Energy recovery, arrow 1.
- ▷ Current consumption, arrow 2.
- ▷ Average consumption, arrow 3.

Current fuel consumption and average fuel consumption

The widget shows the current fuel consumption and average fuel consumption depending on the setting for the display of the trip data.

Navigation data

General information

The estimated time of arrival and the distance remaining to the destination are displayed if a destination is entered in the navigation system before the trip is started.

Display

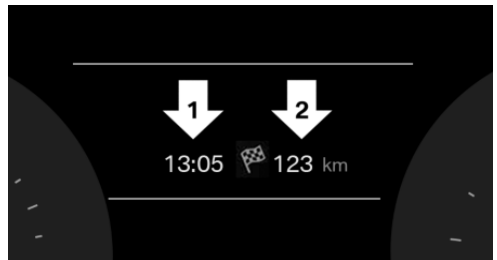

- ▷ Time of arrival, arrow 1.
- ▷ Distance to destination, arrow 2.

Compass

General information

The compass shows the current driving direction.

Display

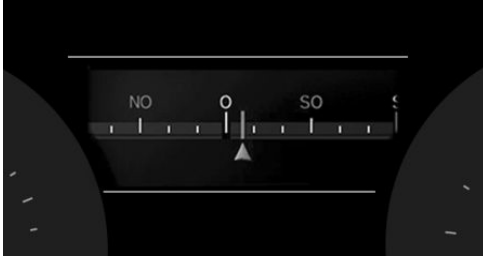

Check Control

Principle

The Check Control system monitors functions in the vehicle and notifies you of faults in the monitored systems.

General information

A Check Control message is displayed as a combination of indicator or warning lights and text messages in the instrument cluster and, if applicable, in the Head-up Display.

In addition, an acoustic signal may sound and a text message may appear on the Control Display.

Hiding Check Control messages

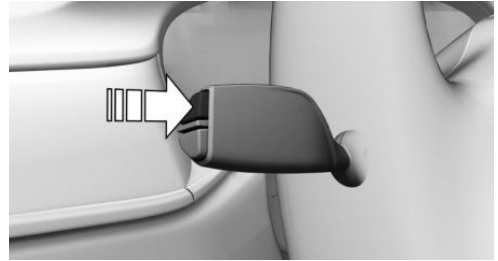

Press the button on the turn signal lever.

Continuous display

Some Check Control messages are displayed continuously and are not cleared until the fault is eliminated. If several faults occur at once, the messages are displayed consecutively.

The messages can be hidden for approx. 8 seconds. After this time, they are displayed again automatically.

Temporary display

Some Check Control messages are hidden automatically after approx. 20 seconds. The Check Control messages are stored and can be displayed again later.

Displaying stored Check Control messages

1. "CAR"
2. "Vehicle status"
3.  "Check Control messages"
4. Select the text message.

Display

Check Control



At least one Check Control message is displayed or stored.

Text messages

Text messages in combination with an icon in the instrument cluster explain a Check Control message and the meaning of the indicator/warning lights.

Supplementary text messages

Additional information, such as the reason for a fault or the required action, can be called up via Check Control.

With urgent messages the added text will be automatically displayed on the Control Display.

Depending on the Check Control message, further help can be selected.

1. "CAR"
2. "Vehicle status"
3.  "Check Control messages"
4. Select the desired text message.
5. Select the desired setting.

Messages after trip completion

Certain messages displayed while driving are displayed again after drive-ready state is switched off.

Indicator/warning lights

Principle

Indicator/warning lights in the instrument cluster display the status of some functions in the vehicle and indicate when a fault is present in the monitored systems.

General information

The indicator/warning lights can light up in a variety of combinations and colors.

Several of the lights are checked for proper functioning and light up temporarily when drive-ready state is switched on.

Red lights

Safety belt reminder



Indicator light flashes or is illuminated: safety belt on the driver or passenger side is not buckled. The safety belt reminder can also be activated if objects are placed on the front passenger seat.

Make sure that the safety belts are positioned correctly.

Safety belt reminder for rear seats



The safety belt is not buckled on the corresponding rear seat.



The displays may vary depending on the equipment version and country variant.

Airbag system



Airbag system and seat belt tensioner may not be working.

Have the vehicle checked immediately by a dealer's service center or another qualified service center or repair shop.

Parking brake



The parking brake is set.

Additional information:

For releasing the parking brake, refer to page 136.

Brake system



Brake system impaired. Continue to drive moderately.



Have the vehicle checked immediately by a dealer's service center or another qualified service center or repair shop.

Approach control warning with light braking function



The indicator light is illuminated: pre-warning. Brake and increase distance.

Indicator light flashes and an acoustic signal sounds: acute warning. Brake and make an evasive maneuver, if necessary.

Additional information:

Approach control warning with light braking function, refer to page [184](#).

Intersection collision warning



The indicator light is illuminated: risk of collision with crossing vehicle.



Indicator light is illuminated: risk of collision with vehicle without detectable driving direction or prewarning for vehicles that cross own driving direction.

Intervene yourself, for instance by braking.

Indicator light flashes and an acoustic signal sounds: acute warning when vehicles cross own driving direction.

Brake and make an evasive maneuver, if necessary.

Additional information:

Intersection collision warning, refer to page [189](#).

Pedestrian Warning with City Collision Mitigation



Indicator light flashes and an acoustic signal sounds: imminent collision with a detected person or a cyclist.

Intervene immediately by braking or make an evasive maneuver.

Additional information:

Pedestrian Warning with City Collision Mitigation, refer to page [193](#).

Active Cruise Control with Stop&Go function



Indicator light flashes and an acoustic signal sounds: braking and evading.

Additional information:

Active Cruise Control with Stop&Go function, refer to page [220](#).

Steering Assistant



Indicator light flashes and an acoustic signal sounds: the system will be switched off.

Additional information:

Steering and Lane Control Assistant, refer to page [230](#).

Drive power



Reduced drive power due to an overheated drivetrain.

Additional information:

Power gauge, refer to page [160](#).

Yellow lights

Steering Assistant



The indicator light lights up and an acoustic signal may sound: a system interruption is imminent.

The indicator warning light flashes: lane marking driven over.

Additional information:

Steering and Lane Control Assistant, refer to page [230](#).

Antilock Braking System ABS





The Brake Assistant function may not activate. Avoid abrupt braking. Take the longer braking distance into account.

Have the system immediately checked by a dealer's service center or another qualified service center or repair shop.

DSC Dynamic Stability Control



The indicator light flashes: DSC controls the drive and braking forces. The vehicle is stabilized. Reduce speed and modify your driving style to the driving circumstances.

The indicator light lights up: DSC has malfunctioned.

Have the system immediately checked by a dealer's service center or another qualified service center or repair shop.

Additional information:

DSC Dynamic Stability Control, refer to page [212](#).

DSC Dynamic Stability Control is deactivated or DTC Dynamic Traction Control is activated



DSC is deactivated or DTC is activated.

Additional information:

- ▶ DSC Dynamic Stability Control, refer to page [212](#).
- ▶ DTC Dynamic Traction Control, refer to page [214](#).

Flat Tire Monitor FTM



The FTM signals a tire pressure loss in a tire.

Reduce your speed and stop cautiously.

Avoid sudden braking and steering maneuvers.

Additional information:

Run-flat tires, refer to page [338](#).

Tire pressure monitor



The indicator light illuminates: the Tire Pressure Monitor reports a low tire pressure or a flat tire. Follow the information in the Check Control message.

The indicator light flashes and is then illuminated continuously: flat tires or tire pressure losses cannot be detected.

- ▶ Fault caused by systems or devices with the same radio frequency: after leaving the area of the interference, the system automatically becomes active again.
- ▶ In the case of tires with special approval: the tire pressure monitor was unable to complete the reset. Reset the system again.
- ▶ A wheel without wheel electronics is mounted: have it checked by a dealer's service center or another qualified service center or repair shop as needed.
- ▶ Malfunction: have the system checked by a dealer's service center or another qualified service center or repair shop.

Additional information:

Tire pressure monitor, refer to page [331](#).

Steering system



Steering system may not be working.

Have the system checked by a dealer's service center or another qualified service center or repair shop.

Emissions



▶ The warning light lights up: Emissions are deteriorating. Have the vehicle checked as soon as possible.

- ▶ The warning light flashes under certain circumstances:

This indicates that there is excessive misfiring in the engine.

Reduce the vehicle speed and have the system checked immediately; otherwise, serious

engine misfiring within a brief period can seriously damage emission control components, in particular the catalytic converter.

Additional information:

Socket for OBD Onboard Diagnosis, refer to page [358](#).

Green lights

Safety belt reminder for rear seats



The safety belt is buckled on the corresponding rear seat.



The displays may vary depending on the equipment version and country variant.

Turn signal



Turn signal switched on.

Unusually rapid blinking of the indicator light indicates that a turn signal bulb has failed.

Additional information:

Turn signal, refer to page [138](#).

Parking lights



Parking lights are switched on.

Additional information:

Parking lights/low beams, refer to page [172](#).

Low beams



Low beams are switched on.

Additional information:

Parking lights/low beams, refer to page [172](#).

Lane departure warning



The indicator light lights up: the system is activated. Warnings can be issued.

Additional information:

Lane departure warning, refer to page [195](#).

Front fog lights



Front fog lights are switched on.

Additional information:

Front fog lights, refer to page [176](#).

Automatic High Beam Assistant



Automatic High Beam Assistant is switched on.

High beams are switched on and off automatically depending on the traffic situation.

Additional information:

Automatic High Beam Assistant, refer to page [174](#).

Automatic Hold



Automatic Hold is activated. The vehicle is automatically held in place when it is stationary.

Additional information:

Automatic Hold, refer to page [136](#).

Manual Speed Limiter



The indicator light lights up: the system is switched on.

The indicator light flashes: the set speed limit has been exceeded.

Additional information:

Manual Speed Limiter, refer to page [216](#).

Cruise control



Indicator light is illuminated: the system is active.

Additional information:

Cruise control, refer to page [218](#).

Active Cruise Control with Stop&Go function



The indicator light lights up: the system is switched on.

Additional information:



Active Cruise Control with Stop&Go function, refer to page [220](#).

Speed Limit Assistant



Depending on the equipment, indicator light illuminates together with the icon for a cruise control system: Speed Limit Assistant is active and detected speed limits can be applied manually for the displayed system.



Indicator light illuminates: the detected speed limit can be applied with the SET button. As soon as the speed limit has been applied, a green checkmark is displayed.

Additional information:

Speed Limit Assistant, refer to page [228](#).

Steering Assistant



Indicator light lights up: the system supports the driver in keeping the vehicle within the lane.

Additional information:

Steering and Lane Control Assistant, refer to page [230](#).

Lane change assistant



Gray line for lane marking on the appropriate side: system detected a lane change request. Lane change not currently possible.



Arrow symbol for lane change green: the system carries out a lane change.



Arrow symbol for lane change gray: lane change not possible; functional requirements not met.

Additional information:

Lane change assistant, refer to page [236](#).

Extended Traffic Jam Assistant



Indicator light is illuminated: the system is active.

Additional information:

Assisted Driving Plus, refer to page [234](#).

Blue lights

High beams



High beams are switched on.

Additional information:

High beams, refer to page [139](#).

Drive power



Reduced drive power due to a cold drivetrain.

Additional information:

Power gauge, refer to page [160](#).

Gray lights

Active Cruise Control with Stop&Go function



Indicator light is illuminated: the system is interrupted.

Indicator light flashes: the conditions are not adequate for the system to work or the system has been deactivated.

Additional information:

Active Cruise Control with Stop&Go function, refer to page [220](#).

Steering Assistant



Indicator light is illuminated: the system is ready.

Additional information:

Steering and Lane Control Assistant, refer to page [230](#).

Extended Traffic Jam Assistant



Indicator light is illuminated: the system is interrupted.

Additional information:

Assisted Driving Plus, refer to page [234](#).

White lights

Extended Traffic Jam Assistant



Indicator light is illuminated: the system is ready.

Additional information:

Assisted Driving Plus, refer to page [234](#).

Fuel gauge

Principle

The current fill level of the fuel tank is displayed.

General information

Vehicle inclination may cause the display to vary.

Additional information:

Refueling, refer to page [314](#).

Display

Instrument cluster with enhanced features:

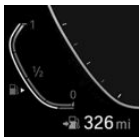

An arrow next to the fuel pump symbol indicates the vehicle side on which the fuel filler flap is located.

The current range is displayed as numerical value.

Instrument cluster without enhanced features:



An arrow next to the fuel pump symbol indicates the vehicle side on which the fuel filler flap is located.

Indicator light in the instrument cluster



The yellow indicator light illuminates, once the fuel reserve is reached.

Tachometer

General information

Always avoid RPM in the red warning field. In this range, the fuel supply is reduced to protect the engine.

Instrument cluster with enhanced features: Activating/deactivating

1. "CAR"
2. "Settings"
3. "Displays"
4. "Instrument panel"
5. "Engine display"
6. "Tachometer"

When the setting for the driving mode view is activated, the activated tachometer is only shown in the COMFORT or SPORT driving mode.

Instrument cluster with extended features: Power gauge

Principle

The display indicates the drive power available as a percentage of its total power.

Activate/deactivate

1. "CAR"
2. "Settings"
3. "Displays"
4. "Instrument panel"
5. "Engine display"
6. "Power meter"

When the setting for the driving mode view is activated, the activated power gauge is only shown in the COMFORT driving mode.

Display

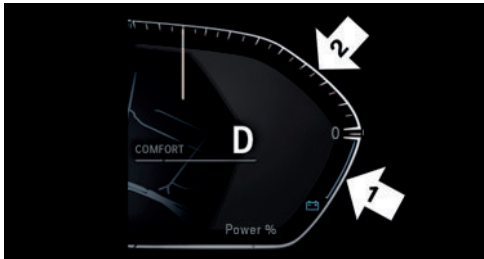



Pointer in the area of arrow 1: display of the energy recovered by coasting or when decelerating, CHARGE.

Pointer in the area of arrow 2: output in percent, POWER.

Drive power

The available drive power may be reduced due to certain factors, for instance a cold engine. Depending on the available drive power, the range for POWER is adjusted automatically.

If needed, icons in the power gauge indicate a reduction of the drive power.

| Example symbol | Description |
|---|--|
|  | Reduced drive power due to a cold drivetrain. |
|  | Reduced drive power due to an overheated drivetrain. |

Shift lights

Principle

The Shift lights in the instrument cluster indicate the maximum shift point at which the best possible acceleration can be achieved.

General information

Depending on the equipment and national-market version, the Shift lights are active in the M manual mode of the Steptronic Sport transmission and with manual transmission.

Functional requirement

- ▷ Depending on the equipment, either driving program SPORT or SPORT PLUS is activated.
- ▷ Head-up display is switched off or the display of the Shift lights in the Head-up display is deactivated.

Turning on/turning off

Steptronic Sport transmission:

1. If applicable, select SPORT or SPORT PLUS driving mode.
Press Driving Dynamics Control.
2. Activate the M manual mode of the transmission.

Display



Full Black Panel Display.

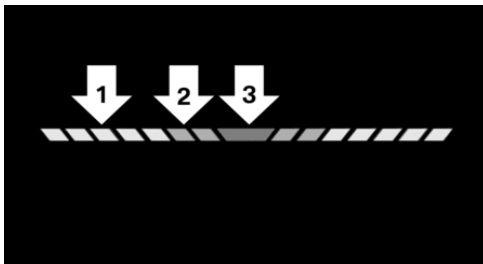

Instrument cluster without enhanced features.

Information about the driving style

- ▶ Current engine speed is displayed in the tachometer.
- ▶ Arrow 1: successive yellow illuminated fields indicate an increase in the speed.
- ▶ Arrow 2: successive orange illuminated fields indicate the upcoming shift moment.
- ▶ Arrow 3: the field lights up red. Do not wait any further to shift.

When the maximum speed is reached, the entire display flashes red and the fuel supply is interrupted in order to protect the engine.

Standby state and drive-ready state

Instrument cluster with enhanced features:



The lettering OFF in the instrument cluster indicates that drive-ready state is switched off and standby state is switched on.



The letters READY in the instrument cluster indicate that the drive readiness is turned on and the Auto Start/Stop function is ready to start the engine automatically.

Instrument cluster without enhanced features:

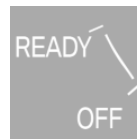

The letters OFF in the tachometer indicate that drive-ready state is switched off and standby state is switched on.

The letters READY in the instrument cluster indicate that the drive readiness is turned on and the Auto Start/Stop function is ready to start the engine automatically.

Additional information:

Operating state of the vehicle, refer to page 41.

Engine oil temperature

Display

Instrument cluster with enhanced features:



- ▶ Cold engine: the pointer is at the low temperature end. Drive at moderate RPM and vehicle speeds.
- ▶ Normal operating temperature: the pointer is in the middle or in the lower half of the temperature display.

- ▶ Hot engine: the pointer is at the high end of the temperature range. In addition, a Check Control message is displayed.

Instrument cluster without enhanced features:



- ▶ Cold engine: the LEDs of the indicator show a low temperature value. Drive at moderate RPM and vehicle speeds.
- ▶ Normal operating temperature: the LEDs of the indicator show an average temperature value.
- ▶ Hot engine: the LEDs of the indicator show a high temperature value. In addition, a Check Control message is displayed.

Additional information:

Coolant level, refer to page 355.

Indicator light in the instrument cluster



A red indicator light is displayed.

Outside temperature

General information

If the indicator drops to $+37\text{ °F}/+3\text{ °C}$ or lower, a signal sounds.

A Check Control message is displayed.

There is an increased risk of ice on roads.

Safety information

Warning

Even at temperatures above $+37\text{ °F}/+3\text{ °C}$ there can be a risk of icy roads, for instance on bridges or shady sections of the road. There is a risk of accident. Modify your driving style to the weather conditions at low temperatures.

Range

Principle

The range indicates the distance that can still be covered with the current full tank of fuel.

General information

The estimated range available with the remaining fuel is permanently displayed in the instrument cluster.

With a low remaining range, a Check Control message is briefly displayed. With a sporty driving style, for instance fast cornering, the engine function is not always ensured.

The Check Control message appears continuously below a range of approx. 30 miles/50 km.

Safety information

NOTICE

With a driving distance of less than 30 miles/50 km the engine may no longer have sufficient fuel. Engine functions are not ensured anymore. There is a risk of damage to property, among other potential damage. Refuel promptly.

Display

Instrument cluster with enhanced features:



The current range is displayed as numerical value next to the fuel gauge.

Instrument cluster without enhanced features:

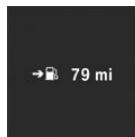

The current range is displayed as numerical value between speedometer and tachometer.

Service notifications

Principle

The function displays the service notifications and the corresponding maintenance scopes.

General information

After switching on drive-ready state, the instrument cluster briefly displays available driving distance or time to the next scheduled maintenance.

A service advisor can read out the current service notifications from your vehicle key.



Display

Detailed information on service notifications

More information on the type of service required may be displayed on the Control Display.

1. "CAR"
2. "Vehicle status"
3.  "Required services"
Maintenance work and legally mandated inspections are displayed.
4. Select an entry to call up detailed information.

Symbols

| Sym-bols | Description |
|--|---|
|  | No service is currently required. |
|  | The time for recommended maintenance or a legally mandated inspection is approaching. |
|  | Service interval is exceeded. |

Entering appointment dates

Enter the dates for the mandatory vehicle inspections.

Make sure that the vehicle's date and time are set correctly.

1. "CAR"
2. "Vehicle status"
3.  "Required services"
4. "Vehicle inspection"
5. "Date:"
6. Select the desired setting.

Gear shift indicator

Principle

The gear shift indicator recommends the most efficient gear for the current driving situation.



General information

Depending on the vehicle equipment and country version, the gear shift indicator is active in the M manual mode of the Steptronic transmission and with manual transmission.

Steptronic transmission: displaying

Suggestions to shift up or down are displayed in the instrument cluster.

On vehicles without a gear shift indicator, the engaged gear is displayed.

| Example | Description |
|---|----------------------------|
|  | Efficient gear is set. |
|  | Shift into efficient gear. |

Speed Limit Info

Speed Limit Info

Principle

Speed Limit Info shows the currently valid speed limit in the instrument cluster and, if necessary, the Head-up Display.

General information

The camera in the area of the interior mirror detects traffic signs at the edge of the road as well as overhead sign posts.

Traffic signs with extra symbols are considered and compared with the vehicle's onboard data. The traffic sign will then be either displayed or ignored depending on the situation in the instrument cluster and the Head-up Display.

With the navigation system, the system takes into account the information stored in the navigation data and also displays speed limits present on routes without signs.

Without a navigation system, the system is subject to limitations imposed by technology. Traffic signs with speed limitations are detected and displayed only. Speed limitations due to entering or exiting towns, highway signs, etc. are not displayed. Speed limits with extra text characters are always displayed.

Safety information

Warning

The system cannot serve as a substitute for the driver's personal judgment in assessing visibility and traffic situation. There is a risk of accident. Adjust driving style to traffic conditions. Watch traffic closely and actively intervene where appropriate.

Overview

Sensors

The system is controlled by the following sensors:

- ▷ Cameras behind the windshield.

Additional information:

Sensors of the vehicle, refer to page [37](#).

Displaying Speed Limit Info

General information

Depending on the vehicle equipment, Speed Limit Info is displayed permanently in the instrument cluster or via iDrive.

Activating

1. "CAR"
2. "Settings"
3. "Driver Assistance"
4. If necessary, "Driving"
5. "Speed Limit Assistance"
6. "Speed limits"
7. "Show current limit"

Display

Speed Limit Info



Current speed limit.

Without a navigation system the traffic signals are grayed out after curves or longer stretches of roadway.





Depending on the equipment, Speed Limit Info not available.

If the detected speed limit has been exceeded, the indicator light will flash.

Settings

1. "CAR"
2. "Settings"
3. "Driver Assistance"
4. If necessary, "Driving"
5. "Speed Limit Assistance"
6. Select the desired setting:
 - ▷ "Warn when speeding": activate/deactivate the flashing of the Speed Limit Info display in the instrument cluster and, where applicable, the Head-up Display when the currently valid speed limit is exceeded. The warning that is issued when a speed limit is exceeded may depend on the Speed Limit Assistant settings.
 - ▷ "Excess speed display": the speed limit that is detected by the Speed Limit Info is displayed with a marking in the speedometer in the instrument cluster.

System limits

System limits of the sensors

Additional information:

- ▷ Cameras, refer to page 37.

Functional limitations

The system may not be fully functional and may provide incorrect information in the following situations:

- ▷ When traffic signs are fully or partially concealed by objects, stickers or paint.
- ▷ When driving very close to the vehicle in front of you.

- ▷ In the case of navigation data that is invalid, outdated or not available.
- ▷ In areas not covered by the navigation system.
- ▷ When roads differ from the navigation, such as due to changes in road layout.
- ▷ In case of electronic traffic signs.
- ▷ When passing buses or trucks with traffic signs applied to them.
- ▷ When the traffic signs do not correspond to the standard.
- ▷ When traffic signs that are valid for a parallel road are detected.
- ▷ In the presence of country-specific road signs or road layouts.

Selection lists

Concept

Lists can be displayed and, if necessary, used for certain functions in the instrument cluster or the Head-up Display.

- ▷ Entertainment source.
- ▷ Current audio source.
- ▷ List of most recent telephone calls.

If necessary, the corresponding menu will open on the Control Display.



Display



Depending on the equipment version, the list in the instrument cluster may differ from the illustration.

Displaying and using the list

The lists can be displayed and operated using the buttons on the steering wheel.

| Button | Function |
|---|--|
|  | Change the entertainment source. Pressing the button again will close the currently displayed list. |
|  | Show list of most recent telephone calls. |
|  | Turn the thumbwheel to select the desired setting. Press the thumbwheel to confirm the setting. The list of the current entertainment source can be displayed in the instrument cluster again by turning the thumbwheel. |

Trip data

Principle

Values for the trip, such as the average consumption or trip kilometers, are displayed.

General information

The trip data can be displayed on the Control Display and in the instrument cluster.

The values can be displayed and reset depending on various intervals, such as after refueling.

Display on the Control Display

Overview

The following information is displayed depending on the equipment and the set interval and driving mode:

- ▶ Configured interval for displaying trip data.
- ▶ Average fuel consumption depending on the configured interval.
- ▶ Average speed.
- ▶ Total time for shut off engine through the Auto Start/Stop function.
- ▶ Distance traveled in Coasting mode.
- ▶ Consumption history in form of a chart.

Displays

1. "CAR"
2. "Driving information"
3. "Trip data"

Consumption history

The average consumption is shown in the consumption history in form of a chart based on the distance traveled and the driving mode.

Display in the instrument cluster

Depending on the equipment, information about the route can be displayed as widget in the instrument cluster.

The following information is displayed:

- ▶ Total kilometers.
- ▶ Configured interval for displaying trip data.

- ▶ Distance traveled depending on the configured interval.
- ▶ Average speed.

Selecting and setting widgets in the instrument cluster.

Additional information:

Instrument cluster with enhanced features:

Widgets, refer to page 150.

Instrument cluster without enhanced features:

Widgets, refer to page 151.

Adjusting the display of the trip data

The intervals for the display of the trip data in the instrument cluster and on the Control Display are adjustable.

1. "CAR"
2. "Driving information"
3. "Trip data"
4. "Data since"
5. Select the desired setting:
 - ▶ "Start of trip ()": the values are automatically reset approx. four hours after the vehicle has come to a standstill.
 - ▶ "Refueling ()": the values are automatically reset after refueling with a larger quantity of fuel.
 - ▶ "Factory":  Average consumption since delivery from the factory.
The values since the time of the factory delivery are displayed.
 - ▶ "Individual ()": the values since the last manual reset are displayed. The values can be reset at any time.

Resetting average values manually

The following interval can be reset manually at any time: "Individual ()".

With the button on the turn signal lever:

1. Continue to press the button on the turn signal lever until the widget for the trip data is selected.

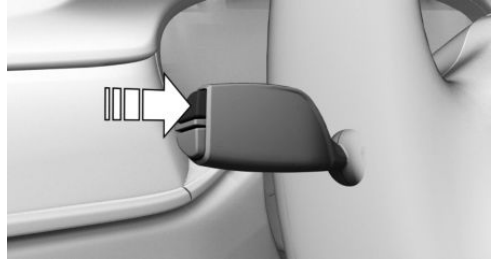

2. Press and hold the button on the turn signal lever.

Via iDrive:

1. "CAR"
2. "Driving information"
3. "Trip data"
4. "Data since"
5. "Reset individual"

The average values and counters are reset. Once the average values and counters have been reset, the following interval is automatically set: "Individual ()".

Sport displays

Concept

The Sport displays especially support a sporty driving style.

Display on the Control Display

Overview

The following information is displayed:

- ▶ Boost pressure.
- ▶ Engine oil temperature.
- ▶ G-Meter.

- ▷ Torque.
- ▷ Power.

Displays

1. "CAR"
2. "Driving information"
3. "Sport displays"

Instrument cluster with enhanced features: Display in the instrument cluster

The Sport displays can be displayed in form of widgets in the instrument cluster.

The following widgets can be selected:

- ▷ Widget for torque and power.
- ▷ Widget for G meter.

Additional information:

Widgets, refer to page [150](#).

Vehicle status



General information



The status can be displayed and actions performed for several systems.

Going to the vehicle status

1. "CAR"
2. "Vehicle status"

Information at a glance

| Symbols | Description |
|---|---|
|  | "Flat Tire Monitor": status of the run-flat tires, refer to page 338 . |
|  | "Tire Pressure Monitor": status of the Tire Pressure Monitor, refer to page 331 . |

| Symbols | Description |
|---|---|
|  | "Engine oil level": electronic oil measurement, refer to page 352 . |
|  | "Check Control messages": displaying stored Check Control messages, refer to page 153 . |
|  | "Required services": displaying service notifications, refer to page 163 . |

Head-up Display

Principle

The Head-up display projects important information in the driver's field of view, for instance the speed.

The driver can get information without averting his or her eyes from the road.

General information

Follow the information on cleaning the Head-up Display.

Overview



Turning on/off

1. "CAR"
2. "Settings"
3. "Displays"

4. "Head-up display"
5. "Head-up display"

Display

Overview

The following information is displayed on the Head-up Display:

- ▷ Vehicle speed.
- ▷ Navigation instructions.
- ▷ Check Control messages.
- ▷ Selection list in the instrument cluster.
- ▷ Driver assistance systems.
- ▷ Sport displays.

Some of this information is only displayed briefly as needed.

Selecting displays in the Head-up Display

1. "CAR"
2. "Settings"
3. "Displays"
4. "Head-up display"
5. Select the desired setting.

Setting the brightness

The brightness is automatically adjusted to the ambient brightness.

The base setting can be adjusted manually.

1. "CAR"
2. "Settings"
3. "Displays"
4. "Head-up display"
5. "Brightness"
6. Turn the Controller until the desired brightness is set.
7. Press the Controller.

When the low beams are switched on, the brightness of the Head-up Display can be adjusted using the instrument lighting.

Adjusting the height

1. "CAR"
2. "Settings"
3. "Displays"
4. "Head-up display"
5. "Height"
6. Turn the Controller until the desired height is reached.
7. Press the Controller.

The height of the Head-up Display can also be stored using the memory function.

Setting the rotation

The Head-up Display view can be rotated.

1. "CAR"
2. "Settings"
3. "Displays"
4. "Head-up display"
5. "Rotation"
6. Turn the Controller until the desired setting is selected.
7. Press the Controller.

Additional settings

1. "CAR"
2. "Settings"
3. "Displays"
4. "Head-up display"
5. Select the desired setting:
 - ▷ "Speed Limit Assistance": access the settings for the speed assistant.
 - ▷ "Display infotainment lists in": set up if the selection lists are displayed in the instrument cluster or the Head-up Display.

- ▷ "Sport displays": display tachometer and shift Lights in the Head-up Display.
 - ▷ "Off": the Sport displays are not displayed in the Head-up Display.
 - ▷ "In SPORT mode": the Sport displays are only displayed in SPORT driving mode.
 - ▷ "Always": the Sport displays are continuously displayed in the Head-up Display.
- ▷ "Reduced height": if not all of the information is in the driver's field of vision, the information can be displayed in the lower section of the Head-up Display.

Visibility of the display

The visibility of the displays in the Head-up Display is influenced by the following factors:

- ▷ Seat position.
- ▷ Objects on the cover of the Head-up Display.
- ▷ Sunglasses with certain polarization filters.
- ▷ Wet road.
- ▷ Unfavorable light conditions.

If the image is distorted, have the base settings checked by a dealer's service center or another qualified service center or repair shop.

Special windshield

The windshield is part of the system.

The shape of the windshield makes it possible to display a precise image.

A film in the windshield prevents double images from being generated.

For this reason, it is strongly suggested to have the special windshield replaced by a dealer's service center or another qualified service center or repair shop, if necessary.

Lights

Vehicle features and options



This chapter describes all standard, country-specific and optional features offered with the series. It also describes features and functions that are not necessarily available in your vehicle, e.g., due to the selected options or country versions. This also applies to safety-related functions and systems. When using these functions and systems, the applicable laws and regulations must be observed.





Lights and lighting

Switches in the vehicle



The light switch element is located next to the steering wheel.

| Icon | Function |
|--|--|
|  | Front fog lights. |
|  | Lights off. Daytime driving lights. |
|  | Parking lights. |

| Icon | Function |
|---|---|
|  | Automatic headlight control. Adaptive light functions. |
|  | Low beams. |
|  | Instrument lighting. |
|  | Right roadside parking light. |
|  | Left roadside parking light. |

Automatic headlight control

Principle

The low beams are switched on and off automatically depending on the ambient brightness, for example in tunnels, in twilight or if there is precipitation.

General information

A blue sky with the sun low on the horizon can cause the lights to be turned on.

If the low beams are switched on manually, the automatic headlight control is deactivated.

Activating

 Press the button on the light switch element.

The LED in the button lights up.



The indicator light in the instrument cluster is illuminated when the low beams are switched on.

System limits

The automatic headlight control cannot replace your personal judgment of lighting conditions.

For example, the sensors are unable to detect fog or hazy weather. In these situations, turn the lights on manually.

Parking lights, low beams and roadside parking lights

General information

If the driver's door is opened when the drive-ready state is switched off, the exterior lighting is automatically switched off after a period of time.

Parking lights

General information

The parking lights can only be switched on in the low speed range.

Switching on



Press the button on the light switch element.



The indicator light in the instrument cluster lights up.

The vehicle is illuminated on all sides.

Do not use the parking lights for extended periods; otherwise, they might drain the battery and it would then be impossible to switch on drive-ready state.

Turning off



Press the button on the light switch element or switch on the drive-ready state.

After the drive-ready state is switched on, the automatic headlight control will be activated.

Low beams

Switching on



Press the button on the light switch element.

The low beams illuminate when drive-ready state is switched on.



The indicator light in the instrument cluster lights up.

Press the button again to switch on the low beams when the standby state is switched on.

Turning off



Depending on the country variant, the low beams can be switched off in the low speed range.



Press the button on the light switch element.

Roadside parking lights

When the vehicle is parked, a one-sided roadside parking light can be switched on.

| Button | Function |
|---|----------------------------------|
|  | Right roadside parking light on. |
|  | Left roadside parking light off. |

Switching off the roadside parking light:



Press the button on the light switch element or switch on the drive-ready state.

Welcome lights

Principle

The exterior lighting is switched on automatically when approaching or unlocking the vehicle.

General information

Depending on the equipment, the exterior lighting of the vehicle can be set individually.

Activating/deactivating welcome light

1. "CAR"
2. "Settings"
3. "Exterior lighting"
4. Depending on the equipment, select the following setting:
 - ▷ "Welcome and goodbye"

When unlocking the vehicle, individual light functions are switched on for a limited time.
 - ▷ "Door handle lights"

Door handles and the ground in front of the doors are illuminated for a limited time.
 - ▷ "Welcome Light Carpet"

The area next to the vehicle is illuminated for a limited time.

LED light carpet

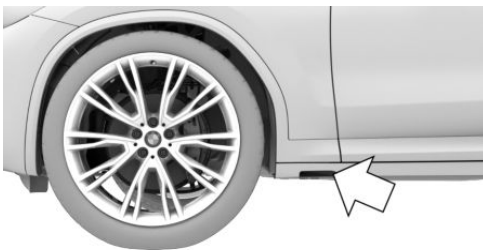

The light source is located in the position indicated.

Keep the light source clean and unobstructed.

Pathway lighting

Principle

For the illumination of the vehicle's surroundings after exiting the vehicle, the exterior lighting can be switched on for a defined period of time.

Switching pathway lighting on

After switching off the drive-ready state, briefly push the turn signal lever forward.

Setting the duration

1. "CAR"
2. "Settings"
3. "Exterior lighting"
4. "Pathway lighting"
5. Select the desired setting.
6. "OK"

Daytime driving lights

General information

The daytime driving lights light up when drive-ready state is switched on.

Activate/deactivate daytime driving lights

In some countries, daytime driving lights are mandatory, so it may not be possible to deactivate the daytime driving lights in front.

1. "CAR"
2. "Settings"
3. "Exterior lighting"
4. Depending on country specifications:
 - "Daytime driving lights" or "Daytime driving lights, rear"

Adaptive light functions

Principle

Adaptive light functions enable dynamic illumination of the road.

General information

The adaptive light functions may consist of one system or multiple systems, depending on the equipment version:

- ▷ Adaptive Light Control.
- ▷ Cornering light.

Activating



Press the button on the light switch element.

The LED in the button lights up.

The adaptive light functions are active when the drive-ready state is switched on.

Adaptive Light Control

General information

Depending on the steering angle and other parameters, the light from the headlight follows the course of the road.

To avoid blinding oncoming traffic, the Adaptive Light Control does not swivel to the opposite lane when the vehicle is at a standstill.

Cornering light

Principle

In tight curves, for instance on mountainous roads or when turning, an additional, cornering light is switched on that lights up the inside of the curve when the vehicle is moving below a certain speed.

General information

The cornering light is automatically switched on depending on the steering angle or, where applicable, the use of turn signals.

When driving in reverse, the cornering lights may be automatically switched on regardless of the steering angle.

Adaptive headlight range control

The adaptive headlight range control feature balances out acceleration and braking processes as well as the vehicle load conditions in order to avoid blinding oncoming traffic.

Automatic High Beam Assistant

Principle

The Automatic High Beam Assistant detects other road users early on and automatically switches the high beams on or off depending on the traffic situation.

General information

The Automatic High Beam Assistant ensures that the high beams are switched on, whenever the traffic situation allows. In the low speed range, the high beams are not switched on by the system.

The system responds to light from oncoming traffic and traffic driving ahead of you, and to ambient lighting, for instance in towns and cities.

The high beams can be switched on and off manually at any time.

Activate Automatic High Beam Assistant

1. **AUTO** Press the button on the light switch element.
The LED in the button lights up.
2. Press the button on the turn signal lever.

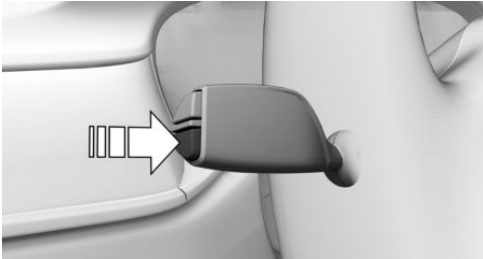

The indicator light in the instrument cluster is illuminated when the low beams are switched on.

The headlights are automatically switched between low beams and high beams.



The blue indicator light in the instrument cluster lights up when the system switches on the high beams.

Driving interruption with activated Automatic High Beam Assistant: the Automatic High Beam Assistant remains activated when driving continues.

The Automatic High Beam Assistant is deactivated when manually switching the high beams on and off.

To reactivate the Automatic High Beam Assistant, press the button on the turn signal lever.

Deactivate Automatic High Beam Assistant

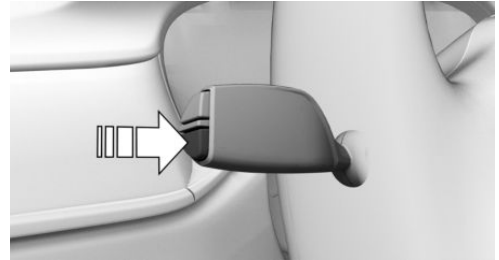

Press the button on the turn signal lever.

Sensitivity of the Automatic High Beam Assistant

General information

The sensitivity of the Automatic High Beam Assistant can be adjusted.

Safety information

Warning

If adjustments have been made or the sensitivity has been modified, oncoming traffic may be momentarily blinded. There is a risk of accident. If adjustments have been made and the sensitivity has been modified, make sure that oncoming traffic is not momentarily blinded. Switch off the high beams manually if required.

Functional requirements

- ▶ Setting at standstill only.
- ▶ Drive readiness is switched on.
- ▶ Light is turned off.

Increase sensitivity

Push the turn signal lever to the front for approximately 10 seconds.

A Check Control message is displayed. The system responds more sensitively.

Resetting the sensitivity

Push the turn signal lever to the front again for approx. 10 seconds or switch off the drive-ready state.

The sensitivity of the Automatic High Beam Assistant is reset to the factory settings.

System limits

The Automatic High Beam Assistant cannot replace the driver's personal judgment of when to use the high beams. In situation that require this, therefore dimming manually.

The system is not fully functional in the following situations, and driver intervention may be necessary:

- ▷ In very unfavorable weather conditions, such as fog or heavy precipitation.
- ▷ When detecting poorly-lit road users such as pedestrians, cyclists, horseback riders and wagons; when driving close to train or ship traffic; or at animal crossings.
- ▷ In tight curves, on hilltops or in depressions, in crossing traffic or half-observed oncoming traffic on highways.
- ▷ In poorly-lit towns and cities or in the presence of highly reflective signs.
- ▷ When the windshield in front of the interior mirror is fogged up, dirty or covered with stickers, etc.

Laser high beams

Principle

The headlight range of the high beams is increased and provides better illumination of the road.

General information

When the high beams are switched-on, starting with a speed of approx. 37 mph/60 km/h, the laser high beams in the headlight are automatically switched on in addition to the LED high beams.

Depending on the country variant, further information can be obtained from the laser label on the headlight.

Safety information



The label is in the headlight and is visible from the outside.

Fog lights

Front fog lights

Principle

The front fog lights work alongside the low beams to illuminate a wider area of the roadway.

Functional requirement

- ▷ Low beams are switched on.

Front fog light on/off

 Press the button.

 The green indicator light in the instrument cluster lights up if the front fog lights are switched on.

If the automatic headlight control is activated, the low beams will come on automatically when you switch on the front fog lights.

When the high beams or headlight flasher are activated, the front fog lights are not switched on.

Instrument lighting

Functional requirement

The parking lights or low beams must be switched on to set the brightness.

Setting the brightness



Adjust the brightness with the thumbwheel.

Interior lighting

General information

Depending on the equipment version, interior lights, footwell lights, entry lights, ambient lighting, and speaker lighting are automatically controlled.

Overview

Buttons in the vehicle



Interior lights



Reading lights

Turning interior lights on/off



Press the button.

To switch off permanently: press the button and hold for approx. 3 seconds.

The interior lights in the rear of the vehicle can be switched on and off independently. The button is located in the rear headliner.

Turning reading lights on/off



Press the button.

Depending on the vehicle equipment, the reading lights are located next to the interior lights in the front and rear.

Ambient light

General information

Depending on the equipment version, lighting can be adjusted for some lights in the car's interior.

Activating/deactivating ambient light

1. "CAR"
2. "Settings"
3. "Interior lighting"
4. "Ambient lighting"

Turning ambient light on/off

The ambient light is switched on when the vehicle is unlocked, and switched off when the vehicle is locked.

If the ambient light was deactivated via iDrive, it will not be switched on when the vehicle is unlocked.

Selecting the color

1. "CAR"
2. "Settings"
3. "Interior lighting"

4. "Color"
5. Select the desired setting.

Setting the brightness

1. "CAR"
2. "Settings"
3. "Interior lighting"
4. "Brightness"
5. Select the desired setting.

Dynamic light

Individual actions, for example incoming calls or opened doors, are indicated by light effects.

1. "CAR"
2. "Settings"
3. "Interior lighting"
4. "Dynamic light"
5. Select the desired setting.

Dimmed while driving

Some lights of the interior lighting are dimmed when the vehicle is driven in the dark.

1. "CAR"
2. "Settings"
3. "Interior lighting"
4. "Dimmed for night driving"

Safety

Vehicle features and options

This chapter describes all standard, country-specific and optional features offered with the series. It also describes features and functions that are

not necessarily available in your vehicle, e.g., due to the selected options or country versions. This also applies to safety-related functions and systems. When using these functions and systems, the applicable laws and regulations must be observed.

Airbags

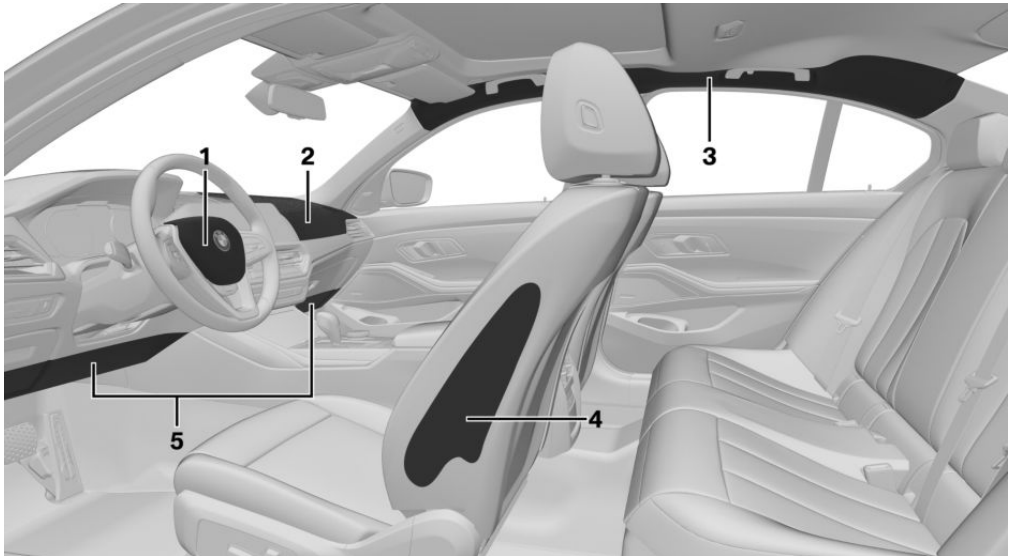

- 1 Front airbag, driver
- 2 Front airbag, front passenger
- 3 Head airbag
- 4 Side airbag
- 5 Knee airbag

Front airbags

Front airbags help protect the driver and the front passenger by responding to frontal impacts in which safety belts alone would not provide adequate protection.

Side airbag

In the event of a side collision, the side airbag protects the side of the body in the chest and lap area.

Head airbag

In the event of a side collision, the head airbag protects the head.

Ejection Mitigation

The head airbag system is designed as an ejection mitigation countermeasure to reduce the likelihood of ejections of vehicle occupants through side windows during rollovers or side collision events.

Knee airbag

Depending on the national-market version:

The knee airbag protects the legs in the event of a frontal impact.

Protective effect

General information

Airbags are not triggered in every impact situation, e.g., in less severe accidents.

Information on optimum protective effect of the airbags

Warning

If the seat position is incorrect or the deployment area of the airbags is impaired, the airbag system cannot provide protection as intended and may cause additional injuries due to triggering. There is a risk of injury or danger to life. Follow the information on achieving the optimum protective effect of the airbag system.

- ▷ Keep a distance from the airbags.
- ▷ Always grasp the steering wheel on the steering wheel rim. Hold your hands at the 3 o'clock and 9 o'clock positions, to keep the risk of injury to your hands or arms as low as possible when the airbag is triggered.
- ▷ Adjust seat and steering wheel so that hands can be crossed over the steering wheel. Select the settings so that the shoulder rests

against the backrest when crossing the hands and the upper body is as far back as possible while still maintaining a comfortable grip on the steering wheel.

- ▷ Make sure that the front passenger is sitting correctly, i.e., keeps his or her feet and legs in the floor area and does not support them on the dashboard.
- ▷ Make sure that occupants keep their heads away from the side airbag.
- ▷ There should be no additional persons, animals or objects between an airbag and a person.
- ▷ Dashboard and windshield on the front passenger side must stay clear - do not attach adhesive film or coverings and do not attach brackets or cables, for instance for navigation devices or mobile phones.
- ▷ Do not bond the airbag cover panels with adhesive, do not cover them or modify them in any way.
- ▷ Do not use the cover of the front airbag on the front passenger side as a storage area.
- ▷ Do not attach slip covers, seat cushions or other objects to the front passenger seat that are not specifically suited for seats with integrated side airbags.
- ▷ Do not hang pieces of clothing, such as jackets, over the backrests.
- ▷ Never modify either the individual components or the wiring in the airbag system. This also applies to steering wheel covers, the dashboard, and the seats.
- ▷ Do not disassemble the airbag system.

Even when you follow all instructions very closely, injury from contact with the airbags cannot be fully ruled out in certain situations.

The ignition and inflation noise may lead to short-term and, in most cases, temporary hearing impairment in sensitive occupants.

Vehicle modifications for a person with disabilities may affect the air bag system; contact BMW Customer Relations for further information.

Warnings and information on the airbags are also found on the sun visors.

Operational readiness of the airbag system

Safety information

Warning

Individual components can be hot after triggering of the airbag system. There is a risk of injury. Do not touch individual components.

Warning

Improperly executed work can lead to failure, malfunction or unintentional triggering of the airbag system. In the case of a malfunction, the airbag system might not trigger as intended despite the accident severity. There is a risk of injury or danger to life. Have the airbag system checked, repaired, disassembled and scrapped by a dealer's service center or another qualified service center or repair shop.

Display in the instrument cluster



When drive-ready state is turned on, the warning light in the instrument cluster lights up briefly and thereby indicates the operational readiness of the entire airbag system and the seat belt tensioners.

Malfunction



- ▶ Warning light does not come on when drive-ready state is turned on.
- ▶ The warning light lights up continuously.

Have the system checked.

Strength of the driver's and front passenger airbag

General information

The power that triggers the driver's/front passenger airbags depends on the position of the driver's/front passenger seat.

To maintain the accuracy of this function over the long term, calibrate the front seats as soon as a respective message appears on the Control Display.

Calibrating the front seats

Warning

There is a risk of jamming when moving the seats. There is a risk of injury or risk of damage to property. Make sure that the area of movement of the seat is clear prior to any adjustment.

A corresponding message appears on the Control Display.

1. Press the switch and move the respective seat all the way forward, until it stops.
2. Press the switch forward again. The seat still moves forward slightly.
3. Readjust the seat to the desired position.

The calibration procedure is completed when the message on the Control Display disappears.

If the message continues to be displayed, repeat the calibration.

If the message does not disappear after a repeat calibration, have the system checked as soon as possible.

Automatic deactivation of the front passenger airbags

Principle

The system reads if the front passenger seat is occupied by measuring the human body's resistance.

Front, knee, and side airbag on the front passenger's side are activated or deactivated.

General information

Before transporting a child on the front passenger seat, refer to the safety information and instructions for children on the front passenger seat, see Children.

Safety information

Warning

To ensure the front passenger airbag function, the system must be able to detect whether a person is sitting in the front passenger seat. The entire seat cushion area must be used for this purpose. There is a risk of injury or danger to life. Make sure that the front passenger keeps his or her feet in the floor area.

Fault of the automatic deactivation system

When transporting older children and adults, the front passenger airbags may be deactivated in certain seat positions. In this case, the indicator light for the front passenger airbags lights up.

In this case, change the seat position so that the front passenger airbags are activated and the indicator light goes out.

If it is not possible to activate the airbags, have the person sit in the rear.

To enable accurate recognition of the occupied seat cushion:

- ▷ Do not attach covers, cushions, ball mats or other items to the front passenger seat unless they are specifically determined to be safe for use on the front passenger seat.
- ▷ Do not place any electronic devices on the front passenger seat if a child restraint system is to be installed on it.
- ▷ Do not place objects under the seat that can press against the seat from below.
- ▷ No moisture in or on the seat.

Indicator light for the front passenger airbags

The indicator light for the front-seat passenger airbag in the headliner indicates the operating state of the front-seat passenger airbag.

The light indicates whether the airbags are either activated or deactivated.

After drive-ready state is switched on, the light shortly lights up and then indicates whether the airbags are either activated or deactivated.

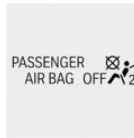

- ▷ The indicator light lights up when a child is properly seated in a child restraint system or when the seat is empty. The airbags on the front passenger side are not activated.
- ▷ The indicator light does not light up when, for instance a correctly seated person of sufficient size is detected on the seat. The airbags on the front passenger side are activated.

Detected child restraint systems

The system generally detects children seated in a child restraint system, particularly in child restraint systems required by NHTSA at the point in time when the vehicle was manufactured. After installing a child restraint system, make sure that the indicator light for the front passenger airbags lights up. This indicates that the child re-

straint system has been detected and the front passenger airbags are not activated.

Intelligent Safety

Principle

Intelligent Safety enables central operation of the driver assistance systems.

General information

Depending on how the vehicle is equipped, Intelligent Safety consists of one or more systems that can help prevent an imminent collision.

- ▶ Approach control warning with light braking function.
- ▶ Evasion Assistant.
- ▶ Intersection collision warning.
- ▶ Daytime Pedestrian Collision Mitigation.
- ▶ Lane departure warning.
- ▶ Active Blind Spot Detection.
- ▶ Side collision mitigation.

Safety information

Warning

The system cannot serve as a substitute for the driver's personal judgment in assessing visibility and traffic situation. There is a risk of accident. Adjust driving style to traffic conditions. Watch traffic closely and actively intervene where appropriate.

Warning

Indicators and warnings cannot serve as a substitute for the driver's personal judgment. Due to its limits, the system may not issue warnings or reactions, or these may be issued late or in a manner that is not consistent with their normal use. There is a risk of accident. Adjust driving

style to traffic conditions. Watch traffic closely and actively intervene where appropriate.

Warning

Due to system limits, individual functions can malfunction during tow-starting/towing with the Intelligent Safety systems activated. There is a risk of accident. Switch all Intelligent Safety systems off prior to tow-starting/towing.

Overview

Button in the vehicle





 Intelligent Safety

Turning on/off

Some Intelligent Safety systems are automatically active after every departure. Some Intelligent Safety systems activate according to the last setting.

Button Status

-  Button lights up green: all Intelligent Safety systems are switched on.
-  Button lights up orange: some Intelligent Safety systems are switched off or currently unavailable.
-  Button does not light up: all Intelligent Safety systems are switched off.



Press the button.

The menu for the Intelligent Safety system is displayed.

If all Intelligent Safety systems were switched off, all systems are now switched on.

"Configure INDIVIDUAL": depending on the equipment version, the Intelligent Safety systems can be individually configured. The individual settings are activated and stored. As soon as a setting is changed on the menu, all settings of the menu are activated.



Press the button repeatedly. The following settings are switched between:

"ALL ON": all Intelligent Safety systems are switched on. Basic settings are activated for the sub-functions, for instance setting for warning time.

"INDIVIDUAL": the Intelligent Safety systems are switched on according to the individual settings.

Some Intelligent Safety systems cannot be individually switched off.



Press and hold this button.

All Intelligent Safety systems are switched off.

Approach control warning with light braking function

Principle

The Forward Collision Warning warns of a possible risk of collision and may brake independently. In the event of an accident, the system may reduce impact speed.

General information

Sensors detect the traffic situation.

The system issues a two-phase warning of a possible risk of collision with vehicles at speeds

above approx. 3 mph/5 km/h. The timing of warnings may vary with the current driving situation.

When the vehicle is driven so that it is intentionally approaching another vehicle, the Forward Collision Warning and brake intervention are delayed in order to avoid false system reactions.

Depending on the vehicle equipment, the Driver Attention Camera in the instrument cluster captures the driver's field of vision. Additionally, the system checks for visual impairments. Field of vision and visibility also affect the timing of the warnings.

Safety information

Warning

The system cannot serve as a substitute for the driver's personal judgment in assessing visibility and traffic situation. There is a risk of accident. Adjust driving style to traffic conditions. Watch traffic closely and actively intervene where appropriate.

Warning

Indicators and warnings cannot serve as a substitute for the driver's personal judgment. Due to its limits, the system may not issue warnings or reactions, or these may be issued late or in a manner that is not consistent with their normal use. There is a risk of accident. Adjust driving style to traffic conditions. Watch traffic closely and actively intervene where appropriate.

Warning

Due to system limits, individual functions can malfunction during tow-starting/towing with the Intelligent Safety systems activated. There is a risk of accident. Switch all Intelligent Safety systems off prior to tow-starting/towing.

Overview

Button in the vehicle



 Intelligent Safety

Sensors

The system is controlled by the following sensors:

- ▷ Cameras behind the windshield.
- ▷ With radar sensor: front radar sensor.

Additional information:

Sensors of the vehicle, refer to page [37](#).

Turning on/off

Turning on automatically

The system is automatically active when the vehicle is turned on.

Switching on manually

 Press the button.

The menu for the Intelligent Safety system is displayed.

If all Intelligent Safety systems were switched off, all systems are now switched on.

"Configure INDIVIDUAL": depending on the equipment version, the Intelligent Safety systems can be individually configured. The individual settings are activated and stored. As soon as a setting is changed on the menu, all settings of the menu are activated.

 Press the button repeatedly.

The following settings are switched between:

"ALL ON": all Intelligent Safety systems are switched on. Basic settings are activated for the subfunctions.

"INDIVIDUAL": the Intelligent Safety systems are switched on according to the individual settings. Some Intelligent Safety systems cannot be individually switched off.

Manual switching off

 Press and hold this button.

All Intelligent Safety systems are switched off.

Button Status

 Button lights up green: all Intelligent Safety systems are switched on.

 Button lights up orange: some Intelligent Safety systems are switched off or currently unavailable.

 Button does not light up: all Intelligent Safety systems are switched off.

Setting the warning time

1. "CAR"
2. "Settings"
3. "Driver Assistance"
4. "Safety and Warnings"
5. "Forward Collision Mitigation"
6. Select the desired setting:
 - ▷ "Early"
 - ▷ "Medium"
 - ▷ "Late": only acute warnings are displayed.

Warning with braking function

Display

A warning symbol appears in the instrument cluster and in the Head-up Display, where available, if a collision with a detected vehicle is imminent.

| Icon | Measure |
|--|---|
|  | Icon lights up red: prewarning. Brake and increase distance. |
|  | Symbol flashes red and an acoustic signal sounds: acute warning. Brake and make an evasive maneuver, if necessary. |



Icon lights up red: prewarning.
Brake and increase distance.



Symbol flashes red and an acoustic signal sounds: acute warning.
Brake and make an evasive maneuver, if necessary.

Prewarning

This warning is provided, for instance when there is impending danger of a collision or the distance to the vehicle ahead is too small.

If a prewarning is provided, respond by braking as warranted.

Acute warning with braking function

An acute warning is displayed in case of the imminent danger of a collision when the vehicle approaches another object at a high differential speed.

Intervene in the case of an acute warning. Depending on the driving situation and the equipment version, the acute warning may be accompanied by a brief activation of the braking system.

With the warning time setting "Late" the brief activation of the braking system is omitted.

If an acute warning is provided, the system may also provide assistance, such as through automatic brake intervention, when there is risk of collision.

Acute warnings may be provided even when there has been no prior warning.

Brake intervention

The warning prompts the driver to intervene. If a warning is active, the maximum braking force is used when the brake is applied. The brake pedal must be applied sufficiently quickly and forcefully.

The system may also assist in braking if there is a risk of collision.

When the vehicle is traveling at a low speed, the vehicle may come to a complete stop.

City brake function: the brake intervention occurs to up to approx. 50 mph/80 km/h.

With radar sensor: the brake intervention occurs to up to approx. 155 mph/250 km/h.

At speeds above approx. 130 mph/210 km/h, the brake intervention occurs as a brief braking pressure. No automatic delay occurs.

The brake intervention can be interrupted by stepping on the accelerator pedal or by actively moving the steering wheel.

The system's ability to detect objects may be limited in some circumstances. Refer to the information in this Owner's Manual regarding the limitations of the system and actively intervene as warranted.

System limits

Safety information

Warning

The system is designed to operate in certain conditions and circumstances. Due to conditions or other factors, the system may not respond. There may be a risk of accident or risk of damage to property. Actively intervene as warranted. Refer to the information in this Owner's Manual regarding the scope of the system's operation and limitations.

Detection range

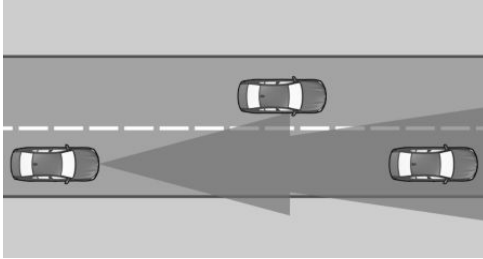

The system's detection capability is limited.

Only objects that are detected by the system are taken into account.

Thus, a system reaction might not come or might come late.

The following situations may not be detected, for instance:

- ▷ Slow moving vehicles when you approach them at high speed.
- ▷ Vehicles that suddenly swerve in front of you, or strongly decelerating vehicles.
- ▷ Vehicles with an unusual rear view.
- ▷ Two-wheeled vehicles ahead of you.

Upper speed limit

If the vehicle speed exceeds approx. 155 mph/250 km/h, the system is deactivated temporarily. When the vehicle slows down to below this speed, the system is reactivated.

System limits of the sensors

Additional information:

- ▷ Cameras, refer to page 37.
- ▷ Radar sensors, refer to page 38.

Functional limitations

The system may be limited in the following situations:

- ▷ In tight curves.
- ▷ If the driving stability control systems are limited or deactivated, for instance DSC OFF.
- ▷ Up to 10 seconds after the start of the engine via the Start/Stop button.

Warning sensitivity

The more sensitive the warning settings are, for example the warning time, the more warnings are displayed. Therefore, there may also be an excess of premature or unjustified warnings and reactions.

Evasion Assistant

Principle

The Evasion Assistant supports the driver in making evasive maneuvers in certain situations, such as when obstacles or persons suddenly appear.

General information

The system issues a warning and intervenes to support the driver if a lateral evasive maneuver is possible. Sensors monitor and detect the clearance around the vehicle. If the system identifies space alongside the vehicle, it supports an evasive maneuver begun by the driver by safely providing targeted supporting steering movements.

Safety information

Warning

The system cannot serve as a substitute for the driver's personal judgment in assessing visibility and traffic situation. There is a risk of accident. Adjust driving style to traffic conditions. Watch traffic closely and actively intervene where appropriate.

Warning

Indicators and warnings cannot serve as a substitute for the driver's personal judgment. Due to its limits, the system may not issue warnings or reactions, or these may be issued late or in a manner that is not consistent with their normal use. There is a risk of accident. Adjust driving style to traffic conditions. Watch traffic closely and actively intervene where appropriate.

Overview**Sensors**

The system is controlled by the following sensors:

- ▷ Cameras behind the windshield.
- ▷ Front radar sensor.
- ▷ Radar sensors, side, front.
- ▷ Radar sensors, side, rear.

Additional information:

Sensors of the vehicle, refer to page 37.

Functional requirements

- ▷ Pedestrian Warning with braking function is switched on.
Pedestrian Warning with City Collision Mitigation, refer to page 193.
- ▷ Approach control warning with light braking function is switched on.
Approach control warning with light braking function, refer to page 184.
- ▷ Sensors detect sufficient clearance around the vehicle.

Turning on/off

The system is automatically active when the vehicle is turned on.

Warning with evasion support**Display in the instrument cluster**

If a collision with a detected vehicle or a detected person is imminent, a warning symbol appears on the instrument cluster and in the Head-up Display.

Icon Measure

Icon lights up red: prewarning.
Brake and increase distance.



Symbol flashes red and an acoustic signal sounds: acute warning for obstacles.
Brake and make an evasive maneuver, if necessary.



Symbol flashes red and an acoustic signal sounds: acute warning for pedestrians.
Brake and make an evasive maneuver, if necessary.

Acute warning with evasion support

An acute warning is displayed when there is an imminent danger of collision due to the vehicle approaching another object at a high speed.

Intervene in the case of an acute warning. The system is designed to provide assistance by taking evasive action when there is a risk of collision.

Acute warnings may be provided even when there has been no prior warning.

System limits**Safety information****Warning**

The system is designed to operate in certain conditions and circumstances. Due to conditions or other factors, the system may not respond. There may be a risk of accident or risk

of damage to property. Actively intervene as warranted. Refer to the information in this Owner's Manual regarding the scope of the system's operation and limitations.

- ▷ In tight curves.
- ▷ If the driving stability control systems are limited or deactivated, for instance DSC OFF.
- ▷ Up to 10 seconds after the start of the engine via the Start/Stop button.

Detection range

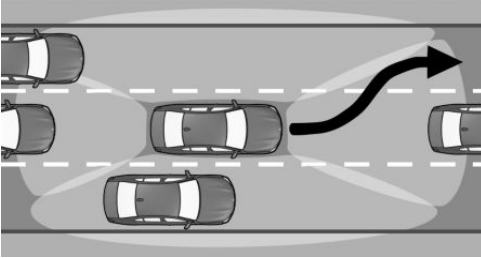

The system's detection capability is limited. Only objects that are detected by the system are taken into account.

Thus, a system reaction might not come or might come late.

The following situations may not be detected, for example:

- ▷ Slow moving vehicles when you approach them at high speed.
- ▷ Vehicles that suddenly swerve in front of you, or strongly decelerating vehicles.
- ▷ Vehicles with an unusual rear view.
- ▷ Two-wheeled vehicles ahead of you.

System limits of the sensors

Additional information:

- ▷ Cameras, refer to page 37.
- ▷ Radar sensors, refer to page 38.

Functional limitations

The system may be limited in the following situations:

Intersection collision warning

Principle

The system may prevent some accidents with cross traffic at intersections and junctions. In the event of an accident, the system may reduce impact speed.

The system sounds a warning in the city speed range before an imminent collision and activates brakes independently, if needed.

General information

Sensors detect the traffic situation.

Vehicles that cross your driving direction can be detected by the system as soon as these vehicles enter into the detection range of the system.

At intersections and junctions, a warning is issued when a danger of collision with crossing traffic is detected.

The system issues a two-phase warning of a possible risk of collision with vehicles at speeds above approx. 6 mph/10 km/h. The timing of warnings may vary with the current driving situation.

The Driver Attention Camera in the instrument cluster captures the driver's field of vision. Additionally, the system checks for visual impairments. Field of vision and visibility also affect the timing of the warnings.

Safety information

Warning

The system cannot serve as a substitute for the driver's personal judgment in assessing visibility and traffic situation. There is a risk of accident. Adjust driving style to traffic conditions. Watch traffic closely and actively intervene where appropriate.

Warning

Indicators and warnings cannot serve as a substitute for the driver's personal judgment. Due to its limits, the system may not issue warnings or reactions, or these may be issued late or in a manner that is not consistent with their normal use. There is a risk of accident. Adjust driving style to traffic conditions. Watch traffic closely and actively intervene where appropriate.

Warning

Due to system limits, individual functions can malfunction during tow-starting/towing with the Intelligent Safety systems activated. There is a risk of accident. Switch all Intelligent Safety systems off prior to tow-starting/towing.

Overview

Button in the vehicle



Intelligent Safety

Sensors

The system is controlled by the following sensors:

- ▷ Cameras behind the windshield.
- ▷ Front radar sensor.
- ▷ Radar sensors, side, front.

Additional information:

Sensors of the vehicle, refer to page [37](#).

Turning on/off

Turning on automatically

The system is automatically active when the vehicle is turned on.

Switching on manually

 Press the button.

The menu for the Intelligent Safety system is displayed.

If all Intelligent Safety systems were switched off, all systems are now switched on.

"Configure INDIVIDUAL": depending on the equipment version, the Intelligent Safety systems can be individually configured. The individual settings are activated and stored. As soon as a setting is changed on the menu, all settings of the menu are activated.

 Press the button repeatedly.

The following settings are switched between:



"ALL ON": all Intelligent Safety systems are switched on. Basic settings are activated for the subfunctions.

"INDIVIDUAL": the Intelligent Safety systems are switched on according to the individual settings.

Some Intelligent Safety systems cannot be individually switched off.

Manual switching off

 Press and hold this button.
All Intelligent Safety systems are switched off.

| Button | Status |
|--|---|
|  | Button lights up green: all Intelligent Safety systems are switched on. |
|  | Button lights up orange: some Intelligent Safety systems are switched off or currently unavailable. |
|  | Button does not light up: all Intelligent Safety systems are switched off. |

Setting the warning time



- "CAR"
- "Settings"
- "Driver Assistance"
- "Safety and Warnings"
- "Forward Collision Mitigation"
- Select the desired setting:
 - ▷ "Early"
 - ▷ "Medium"
 - ▷ "Late": only acute warnings are displayed.

Warning with braking function

Display

General information

A warning symbol appears in the instrument cluster and in the Head-up Display, where available, if a collision with a detected vehicle is imminent.

| Icon | Meaning |
|---|--|
|  | Danger of collision with vehicle crossing from the right. |
|  | Danger of collision with vehicle crossing from the left. |
|  | Danger of collision with vehicle for which the driving direction cannot be determined. |

Display with prewarning

The respective icon lights up red: prewarning for vehicles that cross your driving direction.
Intervene yourself, for instance by braking.

Display with acute warning

The respective icon flashes red and an acoustic signal sounds: acute warning when vehicles cross your driving direction.
Brake and make an evasive maneuver, if necessary.

Prewarning

For example, a prewarning is displayed when a danger of collision with a crossing vehicle is detected.

If a prewarning is provided, respond by braking as warranted.

Acute warning with braking function

An acute warning is displayed in the event of an immediate danger of collision with a crossing vehicle.

Intervene in the case of an acute warning. If an acute warning is provided, the system may provide assistance, such as through automatic brake intervention, when there is risk of collision.

Acute warnings may be provided even when there has been no prior warning.

Brake intervention

The warning prompts the driver to intervene.

The system may also assist in braking if there is a risk of collision.

The vehicle can be decelerated to a standstill.

The brake intervention can be interrupted by stepping on the accelerator pedal or by actively moving the steering wheel.

The system's ability to detect objects may be limited in some circumstances. Refer to the information in this Owner's Manual regarding the limitations of the system and actively intervene as warranted.

System limits

Safety information

Warning

The system is designed to operate in certain conditions and circumstances. Due to conditions or other factors, the system may not respond. There may be a risk of accident or risk of damage to property. Actively intervene as warranted. Refer to the information in this Owner's Manual regarding the scope of the system's operation and limitations.

Upper speed limit

The system responds to crossing vehicles when your own speed is below approx. 50 mph/80 km/h.

Detection range

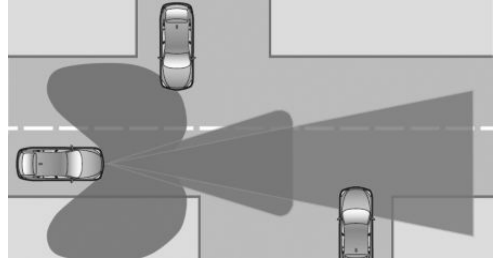

The system's detection capability is limited.

Thus, a system reaction might not come or might come late.

The following situations may not be detected, for instance:

- ▷ Crossing vehicles when they are hidden by buildings, for instance.
- ▷ Vehicles that suddenly swerve in front of you, or strongly decelerating vehicles.
- ▷ Crossing bicycles.
- ▷ Vehicles with an unusual side appearance.

System limits of the sensors

Additional information:

- ▷ Cameras, refer to page 37.
- ▷ Radar sensors, refer to page 38.

Functional limitations

The system may be limited in the following situations:

- ▷ In tight curves.
- ▷ If the driving stability control systems are limited or deactivated, for instance DSC OFF.
- ▷ Up to 10 seconds after the start of the engine via the Start/Stop button.

Warning sensitivity

The more sensitive the warning settings are, for example the warning time, the more warnings are displayed. Therefore, there may also be an ex-

cess of premature or unjustified warnings and reactions.

Pedestrian Warning with City Collision Mitigation

Principle

The Pedestrian Warning warns in the city speed range of possible risk of collision with pedestrians and bicycle riders and may brake independently. In the event of an accident, the system may reduce impact speed.

General information

Sensors detect the traffic situation.

The system issues a warning of a possible risk of collision with pedestrians and cyclists at speeds above approx. 3 mph/5 km/h.

The system reacts to pedestrians and cyclists who are within the detection range of the system.

Safety information

Warning

The system cannot serve as a substitute for the driver's personal judgment in assessing visibility and traffic situation. There is a risk of accident. Adjust driving style to traffic conditions. Watch traffic closely and actively intervene where appropriate.

Warning

Indicators and warnings cannot serve as a substitute for the driver's personal judgment. Due to its limits, the system may not issue warnings or reactions, or these may be issued late or in a manner that is not consistent with their normal use. There is a risk of accident. Adjust driving

style to traffic conditions. Watch traffic closely and actively intervene where appropriate.

Warning

Due to system limits, individual functions can malfunction during tow-starting/towing with the Intelligent Safety systems activated. There is a risk of accident. Switch all Intelligent Safety systems off prior to tow-starting/towing.

Overview

Button in the vehicle



 Intelligent Safety

Sensors

The system is controlled by the following sensors:

- ▶ Cameras behind the windshield.
- ▶ With radar sensor: front radar sensor.

Additional information:

Sensors of the vehicle, refer to page 37.

Detection range

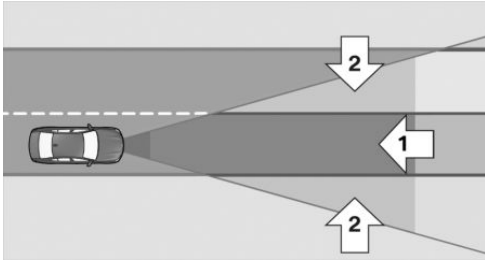

The detection range in front of the vehicle is divided into two areas:

- ▶ Central area, arrow 1, directly in front of the vehicle.
- ▶ Extended area, arrows 2, to the right and left of the central area.

A collision is imminent if pedestrians are located within the central area. A warning is issued about pedestrians who are located within the extended area only if they are moving in the direction of the central area.

Turning on/off

Turning on automatically

The system is automatically active when the vehicle is turned on.

Switching on manually

 Press the button.
The menu for the Intelligent Safety system is displayed.

If all Intelligent Safety systems were switched off, all systems are now switched on.

"Configure INDIVIDUAL": depending on the equipment version, the Intelligent Safety systems can be individually configured. The individual settings are activated and stored. As soon as a setting is changed on the menu, all settings of the menu are activated.

 Press the button repeatedly.
The following settings are switched between:

"ALL ON": all Intelligent Safety systems are switched on. Basic settings are activated for the subfunctions.

"INDIVIDUAL": the Intelligent Safety systems are switched on according to the individual settings. Some Intelligent Safety systems cannot be individually switched off.

Manual switching off

 Press and hold this button.
All Intelligent Safety systems are switched off.

Button Status

 Button lights up green: all Intelligent Safety systems are switched on.

 Button lights up orange: some Intelligent Safety systems are switched off or currently unavailable.

 Button does not light up: all Intelligent Safety systems are switched off.

Warning with braking function

Display

If a collision with a pedestrian or a cyclist is imminent, a warning symbol appears on the instrument cluster and in the Head-up Display.



The red icon is displayed and a signal sounds.



Alternatively, depending on the vehicle equipment, a red warning triangle lights up in the instrument cluster.

Intervene immediately by braking or make an evasive maneuver.

Brake intervention

The warning prompts the driver to intervene. While a warning is active, the maximum braking force is used when the brake is applied. In order to activate the Brake Assistant function, the brakes must be applied sufficiently quickly and forcefully.

If there is a risk of collision, the system may also assist with brake intervention.

When the vehicle is traveling at a low speed, the vehicle may come to a complete stop.

The brake intervention can be interrupted by stepping on the accelerator pedal or by actively moving the steering wheel.

The system's ability to detect objects may be limited in some circumstances. Refer to the information in this Owner's Manual regarding the limitations of the system and actively intervene as warranted.

System limits

Safety information

Warning

The system is designed to operate in certain conditions and circumstances. Due to conditions or other factors, the system may not respond. There may be a risk of accident or risk of damage to property. Actively intervene as warranted. Refer to the information in this Owner's Manual regarding the scope of the system's operation and limitations.

Upper speed limit

The system responds to pedestrians and cyclists when the speed of the vehicle is below approx. 50 mph/80 km/h.

Detection range

The system's detection capability is limited.

Thus, a warning might not be issued or be issued late.

The following situations may not be detected, for instance:

- ▷ Partially covered pedestrians.
- ▷ Pedestrians that are not detected as such because of the viewing angle or contour.
- ▷ Pedestrians outside of the detection range.
- ▷ Pedestrians having a body size less than 32 in/80 cm.

System limits of the sensors

Additional information:

- ▷ Cameras, refer to page 37.
- ▷ Radar sensors, refer to page 38.

Functional limitations

The system may be limited or may not be available in the following situations:

- ▷ If the driving stability control systems are deactivated, for instance DSC OFF.
- ▷ Up to 10 seconds after the start of the engine via the Start/Stop button.

Lane departure warning

Principle

The lane departure warning alerts when the vehicle is about to run off the road or exit the lane.

General information

This camera-based system warns starting at a minimum speed.

The minimum speed is country-specific and is displayed in the menu for the intelligent Safety systems.

Warnings are issued by means of a steering wheel vibration. The severity of the steering wheel vibration can be adjusted.

The system does not provide a warning if the turn signal is set in the respective direction before leaving the lane.

Depending on the equipment version, if in the speed range up to 130 mph/210 km/h a lane marking is crossed, the system may intervene with a brief active steering intervention in addition to vibrating. The system thus helps keep the vehicle in the lane.

Safety information

Warning

The system cannot serve as a substitute for the driver's personal judgment in assessing road and traffic situation. There is a risk of accident. Adjust driving style to traffic conditions. Watch traffic closely and actively intervene where appropriate. Do not jerk the steering wheel in response to a warning.

Warning

Indicators and warnings cannot serve as a substitute for the driver's personal judgment. Due to its limits, the system may not issue warnings or reactions, or these may be issued late or in a manner that is not consistent with their normal use. There is a risk of accident. Adjust driving style to traffic conditions. Watch traffic closely and actively intervene where appropriate.

Functional requirement

The camera must detect the lane markings for the lane departure warning to be active.

Overview

Button in the vehicle



 Intelligent Safety

Sensors

The system is controlled by the following sensors:

- ▶ Cameras behind the windshield.

Additional information:

Sensors of the vehicle, refer to page [37](#).

Turning on/off

Turning on automatically

The lane departure warning activates automatically after departure if the function was switched on at the completion of the last trip.

Depending on the national-market version, the system is automatically active after every driving off. The base setting is thereby activated.

Switching on manually

 Press the button.

The menu for the Intelligent Safety system is displayed.

If all Intelligent Safety systems were switched off, all systems are now switched on.

"Configure INDIVIDUAL": depending on the equipment version, the Intelligent Safety systems can be individually configured. The individual settings are activated and stored. As soon as

a setting is changed on the menu, all settings of the menu are activated.

 Press the button repeatedly.

The following settings are switched between:



"ALL ON": all Intelligent Safety systems are switched on. Basic settings are activated for the subfunctions.

"INDIVIDUAL": the Intelligent Safety systems are switched on according to the individual settings. Some Intelligent Safety systems cannot be individually switched off.

Manual switching off

 Press and hold this button.

All Intelligent Safety systems are switched off.

| Button | Status |
|---|---|
|  | Button lights up green: all Intelligent Safety systems are switched on. |
|  | Button lights up orange: some Intelligent Safety systems are switched off or currently unavailable. |
|  | Button does not light up: all Intelligent Safety systems are switched off. |

Setting the warning time

- "CAR"
- "Settings"
- "Driver Assistance"
- "Safety and Warnings"
- "Lane Departure Warning"
- Select the desired setting:
 - ▷ "Early"
 - ▷ "Medium"
 - ▷ "Reduced": some warnings are suppressed depending on the situation, for instance when purposely driving over

lane markings in curves or with dynamic passing without blinker.

- ▷ "Off": no warnings are issued.

Setting the intensity of the steering wheel vibration

- "CAR"
- "Settings"
- "Driver Assistance"
- "Steering Wheel Feedback"
- "Vibration intensity"
- Select the desired setting.

The setting is applied to all Intelligent Safety systems.

Switch steering intervention on/off

The steering intervention can be switched on and off separately for Active Blind Spot Detection and lane departure warning.

- "CAR"
- "Settings"
- "Driver Assistance"
- "Safety and Warnings"
- "Lane Departure Warning"
- "Steering intervention"

Depending on the national-market version, the steering intervention is automatically active after every driving off.

Display in the instrument cluster



The icon illuminates green: at lane marking was detected on at least one side of the vehicle and warnings can be issued.

Warning function

If you leave the lane

If you leave the lane and if a lane marking has been detected, the steering wheel vibrates in ac-

cordance with the steering wheel vibration setting.

When the turn signal is switched on in the corresponding direction before changing the lane, a warning is not issued.

Steering intervention

Depending on the equipment version: if, in the speed range up to 130 mph/210 km/h a lane marking is crossed, the system may intervene with a brief active steering intervention in addition to vibrating. The steering intervention helps keep the vehicle in the lane. The steering intervention can be noticed on the steering wheel and can be manually overridden at any time. During an active steering intervention, the display in the instrument cluster will blink.

Warning signal

Depending on the equipment version: in the event of multiple active steering interventions by the system within 3 minutes without the driver's intervention at the steering wheel, an acoustic warning will sound. A short warning signal will sound at the second steering intervention. Beginning with the third steering intervention, an continuous warning will sound.

In addition, a Check Control message is displayed.

The warning signal and Check Control message are an encouragement to pay closer attention to the lane.

End of warning

For instance, the warning will be canceled in the following situations:

- ▶ Automatically after a few seconds.
- ▶ When returning to your own lane.
- ▶ When braking hard.
- ▶ When blinking.
- ▶ The Dynamic Stability Control (DSC) adjusts.

System limits

Safety information

Warning

The system is designed to operate in certain conditions and circumstances. Due to conditions or other factors, the system may not respond. There may be a risk of accident or risk of damage to property. Actively intervene as warranted. Refer to the information in this Owner's Manual regarding the scope of the system's operation and limitations.

System limits of the sensors

Additional information:

- ▶ Cameras, refer to page 37.

Functional limitations

The system may be limited in the following situations:

- ▶ In the event of missing, worn, poorly visible, merging, diverging, or multiple lane markings such as in construction areas.
- ▶ With lane boundaries that are covered in snow, ice, dirt or water.
- ▶ In tight curves or on narrow roads.
- ▶ With lane boundaries that are covered by objects.
- ▶ When driving very close to the vehicle in front of you.
- ▶ Up to 10 seconds after the start of the engine via the Start/Stop button.

A Check Control message may be displayed when the system is not fully functional.

Active Blind Spot Detection

Principle

Active Blind Spot Detection detects vehicles in the blind spot or vehicles approaching from behind in the adjacent lane.

The light in the exterior mirror warns the driver in different steps.

General information

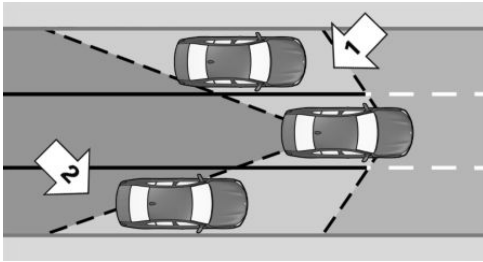

Radar sensors monitor the area behind and next to the vehicle when traveling faster than a minimum speed.

The minimum speed is country-specific and is displayed in the menu for the intelligent Safety systems.

The system indicates whether there are vehicles in the blind spot, arrow 1, or approaching from behind in the adjacent lane, arrow 2.

The light in the exterior mirror lights up dimmed.

Before you change lanes after setting the turn signal, the system issues a warning in the situations described above.

The light in the exterior mirror flashes and the steering wheel vibrates.

Vehicles with side collision mitigation: at speeds of up to 130 mph/210 km/h, the system can intervene with a brief active steering intervention and help guide the vehicle back into the lane. The steering intervention occurs when a minimum speed is reached. This minimum speed is

displayed on the Control Display in the menu for the steering intervention.

Safety information

Warning

The system cannot serve as a substitute for the driver's personal judgment in assessing visibility and traffic situation. There is a risk of accident. Adjust driving style to traffic conditions. Watch traffic closely and actively intervene where appropriate.

Warning

Indicators and warnings cannot serve as a substitute for the driver's personal judgment. Due to its limits, the system may not issue warnings or reactions, or these may be issued late or in a manner that is not consistent with their normal use. There is a risk of accident. Adjust driving style to traffic conditions. Watch traffic closely and actively intervene where appropriate.

Overview

Button in the vehicle



 Intelligent Safety

Sensors

The system is controlled by the following sensors:

- ▷ Radar sensors, side, rear.

Additional information:

Sensors of the vehicle, refer to page 37.

Turning on/off

Turning on automatically

Active Blind Spot Detection is automatically activated after departure if the function was switched on at the completion of the last trip.

Switching on manually



Press the button.

The menu for the Intelligent Safety system is displayed.

If all Intelligent Safety systems were switched off, all systems are now switched on.

"Configure INDIVIDUAL": depending on the equipment version, the Intelligent Safety systems can be individually configured. The individual settings are activated and stored. As soon as a setting is changed on the menu, all settings of the menu are activated.



Press the button repeatedly.

The following settings are switched between:

"ALL ON": all Intelligent Safety systems are switched on. Basic settings are activated for the subfunctions.

"INDIVIDUAL": the Intelligent Safety systems are switched on according to the individual settings.

Some Intelligent Safety systems cannot be individually switched off.

Manual switching off



Press and hold this button.

All Intelligent Safety systems are switched off.

| Button | Status |
|---|---|
|  | Button lights up green: all Intelligent Safety systems are switched on. |
|  | Button lights up orange: some Intelligent Safety systems are switched off or currently unavailable. |
|  | Button does not light up: all Intelligent Safety systems are switched off. |

Setting the warning time

1. "CAR"
2. "Settings"
3. "Driver Assistance"
4. "Safety and Warnings"
5. "Active Blind Spot Detection"
6. Select the desired setting.

Setting the intensity of the steering wheel vibration

1. "CAR"
2. "Settings"
3. "Driver Assistance"
4. "Steering Wheel Feedback"
5. "Vibration intensity"
6. Select the desired setting.

The setting is applied to all Intelligent Safety systems.

Vehicles with side collision mitigation: switching steering intervention on/off

The steering intervention can be switched on and off separately for Active Blind Spot Detection and lane departure warning.

1. "CAR"
2. "Settings"
3. "Driver Assistance"

4. "Safety and Warnings"
5. "Active Blind Spot Detection"
6. "Steering intervention"

Warning function

Light in the exterior mirror



Prewarning

The dimmed light in the exterior mirror indicates when there are vehicles in the blind spot or approaching from behind.

Acute warning

When the turn signal is switched on while a vehicle is in the critical zone, the steering wheel vibrates briefly and the light in the exterior mirror flashes brightly.

The warning stops when the other vehicle has left the critical area or the turn signal has been deactivated.

Vehicles with side collision mitigation

When there is no response to the vibration of the steering wheel at speeds of up to 130 mph/210 km/h and the lane marking is crossed, the system intervenes with a brief active steering intervention. The steering intervention helps return the vehicle into the lane. The steering intervention can be noticed on the steering wheel and can be manually overridden at any time.

Flashing of the light

A flashing of the light during vehicle unlocking serves as system self-test.

System limits

Safety information

Warning

The system is designed to operate in certain conditions and circumstances. Due to conditions or other factors, the system may not respond. There may be a risk of accident or risk of damage to property. Actively intervene as warranted. Refer to the information in this Owner's Manual regarding the scope of the system's operation and limitations.

Upper speed limit

If the vehicle speed exceeds approx. 155 mph/250 km/h, the system is deactivated temporarily.

If the vehicle speed falls below approx. 155 mph/250 km/h, the system once again responds according to the setting.

System limits of the sensors

Additional information:

- ▷ Radar sensors, refer to page 38.
- ▷ On vehicles with side collision warning: cameras, refer to page 37.

Functional limitations

The system may be limited in the following situations:

- ▷ When a vehicle is approaching at a speed much faster than your own.
- ▷ In tight curves or on narrow roads.
- ▷ The bumper is dirty, iced up or covered, for instance by stickers.

For vehicles with side collision mitigation, the steering intervention can be limited, for instance in the following situation:

- ▷ In the event of missing, worn, poorly visible, merging, diverging, or multiple lane markings such as in construction areas.
- ▷ With lane boundaries that are covered in snow, ice, dirt or water.
- ▷ With lane boundaries that are not white.
- ▷ With lane boundaries that are covered by objects.
- ▷ When driving very close to the vehicle in front of you.
- ▷ If the camera is impaired.
- ▷ Up to 10 seconds after the start of the engine via the Start/Stop button.

A Check Control message is displayed when the system is not fully functional.

Displaying warnings

Depending on the selected warning settings, e.g., warning time, more or fewer warnings can be displayed. However, there may also be an excess of premature warnings of critical situations.

Side collision mitigation

Principle

The side collision warning helps to avoid imminent side collisions.

General information

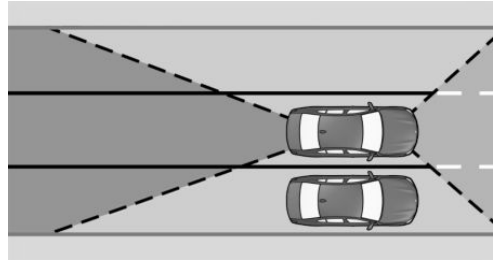

Radar sensors monitor the space next to the vehicle when traveling faster than a minimum speed of up to approx. 130 mph/210 km/h.

The minimum speed is country-specific and is displayed in the menu for the intelligent Safety systems.

The front camera determines the lane marking positions.

If, for instance, another vehicle is detected next to the vehicle and if there is a risk of collision with this vehicle, the system helps avoid the collision. For this purpose, the system issues a warning with a blinking LED in the exterior mirror and a vibrating steering wheel. If necessary, the system will carry out an active steering intervention.

Safety information

Warning

The system cannot serve as a substitute for the driver's personal judgment in assessing visibility and traffic situation. There is a risk of accident. Adjust driving style to traffic conditions. Watch traffic closely and actively intervene where appropriate.

Warning

Indicators and warnings cannot serve as a substitute for the driver's personal judgment. Due to its limits, the system may not issue warnings or reactions, or these may be issued late or in a manner that is not consistent with their normal

use. There is a risk of accident. Adjust driving style to traffic conditions. Watch traffic closely and actively intervene where appropriate.

Functional requirement

The camera must detect the lane markings for the side collision mitigation with steering intervention to be active.

Overview

Button in the vehicle



 Intelligent Safety

Sensors

The system is controlled by the following sensors:

- ▶ Cameras behind the windshield.
- ▶ Radar sensors, side, front.
- ▶ Radar sensors, side, rear.

Additional information:

Sensors of the vehicle, refer to page 37.

Turning on/off

Turning on automatically

The side collision mitigation activates automatically after departure if the function was switched on at the completion of the last trip.

Switching on manually



Press the button.

The menu for the Intelligent Safety system is displayed.

If all Intelligent Safety systems were switched off, all systems are now switched on.

"Configure INDIVIDUAL": depending on the equipment version, the Intelligent Safety systems can be individually configured. The individual settings are activated and stored. As soon as a setting is changed on the menu, all settings of the menu are activated.



Press the button repeatedly.

The following settings are switched between:

"ALL ON": all Intelligent Safety systems are switched on. Basic settings are activated for the subfunctions.

"INDIVIDUAL": the Intelligent Safety systems are switched on according to the individual settings.

Some Intelligent Safety systems cannot be individually switched off.

Manual switching off



Press and hold this button.

All Intelligent Safety systems are switched off.

Button Status



Button lights up green: all Intelligent Safety systems are switched on.



Button lights up orange: some Intelligent Safety systems are switched off or currently unavailable.



Button does not light up: all Intelligent Safety systems are switched off.

Setting the intensity of the steering wheel vibration

1. "CAR"
2. "Settings"
3. "Driver Assistance"
4. "Steering Wheel Feedback"
5. "Vibration intensity"
6. Select the desired setting.

The setting is applied to all Intelligent Safety systems.

Warning function

Light in the exterior mirror



Acute warning

If there is a risk of collision, the light in the exterior mirror flashes and the steering wheel vibrates.

A Check Control message is displayed at the same time.

If necessary, an active steering intervention takes place to prevent the collision and maintain the vehicle within its own lane.

The steering intervention can be noticed on the steering wheel and can be manually overridden at any time.

System limits

Safety information

Warning

The system is designed to operate in certain conditions and circumstances. Due to conditions or other factors, the system may not respond. There may be a risk of accident or risk of damage to property. Actively intervene as warranted. Refer to the information in this Owner's Manual regarding the scope of the system's operation and limitations.

System limits of the sensors

Additional information:

- ▶ Cameras, refer to page 37.
- ▶ Radar sensors, refer to page 38.

Functional limitations

The system may be limited in the following situations:

- ▶ When a vehicle is approaching at a speed much faster than your own.
- ▶ In tight curves or on narrow roads.
- ▶ In the event of missing, worn, poorly visible, merging, diverging, or multiple lane markings such as in construction areas.
- ▶ With lane boundaries that are covered in snow, ice, dirt or water.
- ▶ With lane boundaries that are covered by objects.
- ▶ When driving very close to the vehicle in front of you.
- ▶ Up to 10 seconds after the start of the engine via the Start/Stop button.

A Check Control message is displayed when the system is not fully functional.

Rear-end collision preparation

Principle

Depending on the equipment and national-market version, the rear-end collision preparation can react to vehicles approaching from behind.

General information

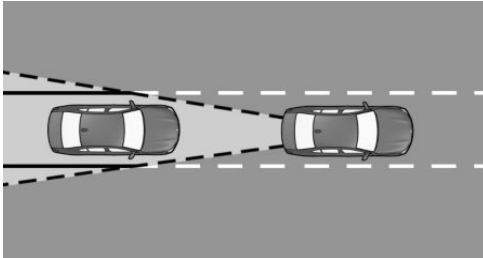

Radar sensors monitor the area behind the vehicle.

When a vehicle approaches from the rear at a certain speed, the system can react as follows:

- ▷ Where applicable, the hazard warning flashers will be switched on.
- ▷ Where applicable, the PreCrash functions are triggered.

Safety information

Warning

The system cannot serve as a substitute for the driver's personal judgment in assessing visibility and traffic situation. There is a risk of accident. Adjust driving style to traffic conditions. Watch traffic closely and actively intervene where appropriate.

Warning

Indicators and warnings cannot serve as a substitute for the driver's personal judgment. Due to its limits, the system may not issue warnings or reactions, or these may be issued late or in a manner that is not consistent with their normal use. There is a risk of accident. Adjust driving style to traffic conditions. Watch traffic closely and actively intervene where appropriate.

Overview

Sensors

The system is controlled by the following sensors:

- ▷ Radar sensors, side, rear.

Additional information:

Sensors of the vehicle, refer to page 37.

Switching on/off

The system is automatically active when the vehicle is turned on.

The system is deactivated in the following situations:

- ▷ When driving in reverse.

System limits

System limits of the sensors

Additional information:

- ▷ Radar sensors, refer to page 38.

Functional limitations

The system may not be fully functional in the following situations:

- ▷ When a vehicle is approaching at a speed much faster than your own.
- ▷ The approaching vehicle is approaching slowly.

If equipped with Equipment Stop Assistant

Principle

If the driver is no longer fit to drive, the Emergency Stop Assistant helps to safely bring the vehicle to a standstill.

General information

The emergency stop function is not triggered automatically. The emergency stop function can only be triggered manually by the occupants.

When the system is activated, the vehicle is brought to a standstill in its own lane by use of lane guidance.

Depending on the equipment version and national market version, the system includes a lane change function.

With lane change function: on motorways or motorway-like roads, the system steers the vehicle to the side of the road or shoulder where possible. On other roads or under high traffic conditions, the vehicle is brought to a standstill on the actual road.

Overview



Parking brake

Functional requirements

- ▷ The function can be activated at speeds of approx. 6 mph/10 km/h up to approx. 155 mph/250 km/h.
- ▷ With lane change function: lane changes are executed when the traffic situation allows.

Activating the emergency stop function

 Pull the switch for the parking brake briefly to activate the emergency stop function.

- ▷ With lane change function: releasing the switch may trigger an automatic lane change.
- ▷ The system will take control of the vehicle for a maximum of 2 minutes.
- ▷ The hazard warning system is switched on.
- ▷ An emergency call is triggered.

Canceling the emergency stop function

The driver can cancel the emergency stop function by actively taking control of the vehicle throughout the entire process.

For instance, the emergency stop function will be canceled in the following situations:

- ▷ When steering.
- ▷ When blinking.
- ▷ When depressing the accelerator pedal.
- ▷ When switching off the hazard warning system.
- ▷ When canceling the Emergency Request.
- ▷ When switching the selector lever position at standstill.
- ▷ When the switch of the parking brake is pressed.

At standstill







As soon as the vehicle is stationary, the system will carry out the following settings:

- ▷ The vehicle is secured against rolling away.
- ▷ The interior lights are switched on.
- ▷ The central locking system is unlocked.

Displays in the instrument cluster

| Icon | Status |
|--|---------------------------------|
|  | Emergency Stop function active. |

Without lane change function:

| Icon | Status |
|--|--|
|  | Green steering wheel symbol: When lane markings are detected, the system keeps the vehicle in the lane. |
|  | Gray steering wheel symbol: Lane guidance is briefly interrupted. |
|  | Yellow steering wheel symbol: Lane marking driven over. When lane markings are detected, the system keeps the vehicle in the lane. |
|  | Yellow steering wheel symbol: The hands are not grasping the steering wheel. The system is still active. |
|  | Red steering wheel symbol and a signal sound: The hands are not grasping the steering wheel. Interruption of lane guidance is imminent. |
|  | Red steering wheel symbol and a signal sound: Lane guidance is switched off. |

System limits

Use the system only in the event of a driver failure.

The system cannot replace the driving performance of a driver who is fit to drive.

BMW Drive Recorder

Principle

The BMW Drive Recorder stores brief video recordings of the vehicle surroundings, e.g., to document surrounding traffic.

General information

There are various ways for storing video recordings:

- ▷ Automatic storage of the recording.
The function allows the documentation of the event of an accident.
- ▷ Manual storage of the recording.
The function allows the documentation of traffic situations.

The system records up to 20 seconds before and after the activation of the storage.

Cameras of the assistance systems are used, for instance Panorama View.

Additionally, the following parameters are stored for the trip:

- ▷ Date.
- ▷ Time.
- ▷ Vehicle speed.
- ▷ Global Positioning System coordinates.

Data protection

The permissibility of recording and using video recordings is contingent upon the statutory regulations of the country in which the system is to be used. The user is responsible for the use of the system and compliance with the respective regulations.

The manufacturer of the vehicle recommends confirming there are no statutory or regulatory constraints on use of the system in your state or country prior to the initial use. In addition, the

laws with respect to use of the system should be verified in regular intervals, especially when borders are frequently crossed.

Other drivers of the vehicle must be informed about the system. In addition, information about the system is required when handing off the vehicle.

Functional requirements

- ▷ BMW Drive Recorder is activated.
- ▷ Privacy Policy accepted.
- ▷ Recording type selected.
- ▷ Recording time selected.

Activating/deactivating the BMW Drive Recorder

The BMW Drive Recorder must be activated before the first use of the recording function.

1. "Apps"
2. "Drive Recorder"
3. Accept Privacy Policy.
4. "Settings"
5. "Recording allowed"
6. Select the desired setting.

Recording functions

Automatic recording

The recording is stored automatically when the vehicle sensors detect an accident occurrence.

Manual recording

Using the button



Press and hold this button.

Via iDrive

1. "Apps"
2. "Drive Recorder"
3. "Start recording"

To stop the recording: "Cancel".

Recording can also be started by selecting the widget on the Control Display.

Recording playback and administration

Stored video recordings can be played back, exported and deleted.

For your own safety, the video recording is only displayed on the Control Display up to approx. 2 mph/3 km/h. In some national-market versions, the video recording is only displayed if the parking brake is engaged or if the selector lever is in selector lever position P.

1. "Apps"
2. "Drive Recorder"
3. "Saved recordings"
4. Select desired recording.
5. Select the desired setting.

If a camera change occurred during the recording, different segments of the video can be selected.

Settings

General information

Different settings can be made.

Recording type

1. "Apps"
2. "Drive Recorder"
3. "Settings"
4. "RECORDING TYPE"
5. Select the desired setting.

Recording time

1. "Apps"
2. "Drive Recorder"
3. "Settings"
4. Select the desired setting.

Cameras

1. "Apps"
2. "Drive Recorder"
3. "Settings"
4. "Camera selection"
5. Select desired camera.

In case of an accident, the system switches automatically to "All" cameras.

If driver assistance systems are active, their camera views are selected automatically.

System limits

In the event of serious accidents, it may not be possible to store recordings if the damage on the vehicle is too great or the power supply was interrupted.

Active Protection

Principle

Active Protection prepares occupants and the vehicle for a possible accident in critical driving or collision situations.

General information

Depending on the equipment and national-market version, Active Protection consists of various PreCrash functions.

The system is used to detect certain critical driving situations that might lead to an accident. This includes the following critical driving situations:

- ▷ Emergency stop.
- ▷ Severe understeering.
- ▷ Severe oversteering.

Certain functions of several systems can, within the system limits, lead to Active Protection triggering:

- ▷ Forward Collision Warning: automatic brake intervention.
- ▷ Front collision mitigation: Brake Assistant
- ▷ Rear collision preparation: detection of imminent rear collisions.

Safety information

Warning

The system cannot serve as a substitute for the driver's personal judgment. Due to the system limits, critical situation could not be detected reliably or in time. There is a risk of accident. Adjust driving style to traffic conditions. Watch traffic closely and actively intervene where appropriate.

Function

When the safety belt is fastened, the driver's and front passenger's belt straps are automatically tightened once after driving away.

In accident-critical situations, the following individual functions become active as needed:

- ▷ Automatic pretensioning of the front safety belts.
- ▷ Automatic window closing up to a narrow gap.
- ▷ Automatic closing of the glass sunroof, including sun protection.
- ▷ For vehicles equipped with comfort seats in the front: automatic positioning of the backrest for the front passenger seat.

After a critical driving situation without an accident, the front safety belts are loosened again.

If the belt tension does not loosen automatically, stop the vehicle and unbuckle the safety belt using the red button in the buckle. Fasten the safety belt before continuing on your trip.

All other systems can be restored to the desired setting.

PostCrash – iBrake

Principle

In the event of an accident, PostCrash can bring the vehicle to a halt automatically without intervention by the driver in certain situations.

General information

PostCrash can reduce the risk of another collision and subsequent consequences.

At standstill

After coming to a halt, the brake is released automatically.

Harder vehicle deceleration

In certain situations, it can be necessary to bring the vehicle to a halt more quickly than the Brake Assistant allows.

To do this, quickly apply extra force to the brake. For a brief period, the braking pressure will be higher than the braking pressure that is achieved by the automatic braking function. Automatic braking is interrupted.

Interrupting automatic braking

It can be necessary to interrupt automatic braking in certain situations, for instance for an evasive maneuver.

Interrupt automatic braking:

- ▷ By pressing the brake pedal.
- ▷ By pressing the accelerator pedal.

Fatigue alert

Principle

The Fatigue Alert can detect decreasing alertness or fatigue of the driver during long, monotonous trips, for instance on highways. The system recommends a break.

Safety information

Warning

The system cannot serve as a substitute for the driver's personal judgment in assessing one's physical state. An increasing lack of alertness or fatigue may not be detected or not be detected in time. There is a risk of accident. Make sure that the driver is rested and alert. Adjust driving style to traffic conditions.

Function

The system is switched on each time drive-ready state is switched on.

After travel has begun, the system monitors certain aspects of the driver's behavior, so that decreasing alertness or fatigue can be detected.

This procedure takes the following criteria into account:

- ▷ Personal driving style, for instance steering behavior.
- ▷ Driving conditions, for instance time, length of trip.
- ▷ Depending on the equipment: attention of the driver through the Driver Attention Camera.

Starting at approx. 43 mph/70 km/h, the system is active and can also display a recommendation to take a break.

Break recommendation

Adjusting

The fatigue alert is active automatically with each switching on of drive-ready state and can thus display a break recommendation.

The break recommendation can also be switched on or off and adjusted via iDrive.

1. "CAR"
2. "Settings"
3. "General settings"
4. "Fatigue and Focus Alert"
5. Select the desired setting.

Display

If the driver becomes less alert or fatigued, a message is displayed in the Control Display with the recommendation to take a break.

During the display, various settings can be selected.

After a break, another recommendation to take a break cannot be displayed until after approximately 45 minutes.

System limits

The function may be limited in the following situations and may issue an incorrect warning or no warning at all:

- ▶ When the time is set incorrectly.
- ▶ When the vehicle speed is mainly below about 43 mph/70 km/h.
- ▶ With a sporty driving style, such as during rapid acceleration or when cornering fast.
- ▶ In active driving situations, such as when changing lanes frequently.
- ▶ When the road condition is poor.
- ▶ In the event of strong side winds.

The system is reset approx. 45 minutes after parking the vehicle, for instance in the case of a break during longer trips on highways.

Driving stability control systems

Vehicle features and options

This chapter describes all standard, country-specific and optional features offered with the series. It also describes features and functions that are not necessarily available in your vehicle, e.g., due to the selected options or country versions. This also applies to safety-related functions and systems. When using these functions and systems, the applicable laws and regulations must be observed.

Antilock Braking System ABS

The Antilock Braking System (ABS) prevents locking of the wheels during braking.

The vehicle maintains its steerability even during emergency braking, which increases the active driving safety.

ABS is operational every time you start the engine.

Brake assistant

The Brake Assistant effects maximum braking assistance when the brake is applied quickly. It reduces the braking distance to a minimum during emergency braking. The advantages of the Antilock Braking System (ABS) are thereby utilized.

Do not reduce the pressure on the brake pedal for the duration of emergency braking.

Adaptive brake assistant

In combination with Active Cruise Control ACC, this system ensures that the brakes respond even more rapidly when braking in critical situations.

Drive-off assistant

Principle

The drive-off assistant supports driving off on uphill grades.

Driving off

1. Hold the vehicle in place with the foot brake.
2. Release the foot brake and drive off without delay.

After the foot brake is released, the vehicle is held in place for approx. 2 seconds.

Depending on the vehicle loading, the vehicle may roll back slightly.

DSC Dynamic Stability Control

Principle

The Dynamic Stability Control (DSC) helps to keep the vehicle on a steady course by reducing drive power and by brake intervention on individual wheels.

General information

DSC detects the following unstable driving conditions, for instance:

- ▶ Skidding, which can lead to oversteering.
- ▶ Loss of adhesion of the front wheels, which can lead to understeering.

Safety information

Warning

The system cannot serve as a substitute for the driver's personal judgment in assessing the traffic situation. Based on the limits of the system, it cannot independently react to all traffic situations. There is a risk of accident. Adjust driving style to traffic conditions. Watch traffic closely and actively intervene where appropriate.

Warning

When driving with a roof load, for instance with roof-mounted luggage rack, the vehicle's center of gravity is higher, which increases the risk of the vehicle tipping in critical driving situations. There may be a risk of accident or risk of damage to property. Driving with roof load only with activated Dynamic Stability Control.

Overview

Button in the vehicle



DSC OFF

Deactivating/activating DSC

General information

When DSC is deactivated, driving stability is reduced during acceleration and when driving in curves.

To increase driving stability, activate DSC again as soon as possible.

Deactivating DSC



Hold the button down until DSC OFF is displayed in the instrument cluster and the DSC OFF indicator light is illuminated.

Activating DSC



Press the button. DSC OFF and the DSC OFF indicator light turn off.

Display

In the instrument cluster

When DSC is deactivated, DSC OFF is displayed in the instrument cluster.

Indicator/warning lights



The indicator light lights up: DSC is deactivated.



The indicator light flashes: DSC controls the drive and braking forces.

The indicator light lights up: DSC has malfunctioned.

DTC Dynamic Traction Control

Principle

Dynamic Traction Control (DTC) is a version of the Dynamic Stability Control (DSC) where drive power is optimized.

The system ensures maximum drive power on unusual road conditions, for instance unplowed snow covered roads, or loose road surfaces, but with somewhat limited driving stability.

General information

When DTC is activated, the vehicle has maximum traction. Driving stability is limited during acceleration and when driving in curves.

You may find it useful to briefly activate DTC in the following situations:

- ▶ When driving in slush or on uncleared, snow-covered roads.
- ▶ When driving off from deep snow or loose ground.
- ▶ When driving with tire chains.

Overview

Button in the vehicle



DSC OFF

Activating/deactivating DTC

Activating DTC



Press the button.

TRACTION is displayed in the instrument cluster and the indicator light for DSC OFF lights up.

Deactivating DTC



Press the button again.

TRACTION and the DSC OFF indicator light turn off.

Display

Display in the instrument cluster

If DTC is activated, TRACTION is displayed in the instrument cluster.

Indicator/warning lights



The indicator light lights up: DTC is activated.

Automatic program change

In certain situations, the Dynamic Stability Control (DSC) is activated automatically:

- ▶ If Active Cruise Control with Stop&Go function ACC is activated.
- ▶ On a brake intervention by the Intelligent Safety systems.
- ▶ The vehicle has a flat tire.

xDrive

Principle

xDrive is the all-wheel-drive system of the vehicle. Concerted action by the xDrive and other suspension control systems, such as Dy-

Dynamic Stability Control (DSC), further optimizes traction and driving dynamics.

General information

xDrive variably distributes the driving power to the front and rear axles as demanded by the driving situation and road condition.

The Driving Dynamics Control is used to change the all-wheel distribution from traction oriented to sport oriented.

Because of the needs-based use of the all-wheel-drive system, Efficient4x4 yields a reduction in consumption.

M sport differential

The active M differential provides for continuously variable locking of the rear axle differential depending on the driving situation. This prevents spinning of a single rear wheel and thereby provides optimal traction in any driving situation.

The driver is responsible adapting his or her driving style to the situation.

Variable sport steering

The variable sport steering facilitates direct and agile handling with little steering effort. The variable sports steering works independently of the current speed, varying the steering ratio in line with the steering angle.

Driver assistance systems

Vehicle features and options

This chapter describes all standard, country-specific and optional features offered with the series. It also describes features and functions that are not necessarily available in your vehicle, e.g., due to the selected options or country versions. This also applies to safety-related functions and systems. When using these functions and systems, the applicable laws and regulations must be observed.

Manual Speed Limiter

Principle



The system can be used to set a speed limit, for instance to prevent the vehicle from exceeding speed limits.

General information

The system can limit the speed, starting at a value of 20 mph/30 km/h. The vehicle can be driven at any speed below the set speed limit.

Overview

Buttons on the steering wheel

| Button | Function |
|--|---|
|  | System on/off. |
|  | Store current speed. Speed Limit Assistant: accept suggested speed manually. |
|  | Rocker switch: Changing the speed limit. |

Operation

Turning on

 Press the button on the steering wheel.

The current speed is accepted as the speed limit.

If the system is switched on while the vehicle is stationary or driving at low speeds, 20 mph/30 km/h is set as the speed limit.

The marking in the speedometer is set to the corresponding speed.

When the speed limit is switched on, DSC Dynamic Stability Control and COMFORT driving mode may be switched on as well.

Turning off

 Press the button on the steering wheel.

The system switches off automatically in the following situations, for example:

- ▶ When the engine is switched off.
- ▶ When cruise control is switched on.
- ▶ When certain programs are activated via the Driving Dynamics Control.

The displays turn off.

Interrupting

If the reverse gear is engaged or at idle, the system is interrupted when rolling backwards.

Changing the speed limit



Press the rocker switch up or down repeatedly until the desired speed limit is set.

- ▶ Each time the rocker switch is pressed to the resistance point, the speed limit increases or decreases by 1 mph/1 km/h.
- ▶ Each time the rocker switch is pressed past the resistance point, the desired speed changes by a maximum of 5 mph/10 km/h.

If the set speed limit is reached or unintentionally exceeded, such as when driving downhill, the vehicle is not actively braked.

When the speed limit is set during a trip to a value below the current speed, the vehicle coasts until it drops to the set speed limit.

The current speed can also be stored by pressing a button:

SET Press the button on the steering wheel.

Exceeding the speed limit

When the vehicle speed exceeds the set speed limit, a warning is issued.

The speed limit can be exceeded intentionally. There is no warning in this case.

Press the accelerator pedal all the way down to intentionally exceed the set speed limit.

When the vehicle speed drops below the set speed limit, the limit is automatically reactivated.

Warning when the speed limit is exceeded

Visual warning



If the speed limit is exceeded: the indicator light in the instrument cluster flashes while the vehicle speed is greater than the set speed limit.

Acoustic warning

- ▶ If the speed limit is exceeded unintentionally, a signal sounds.
- ▶ When the speed limit is reduced to below the vehicle speed while driving, the signal sounds after some time.
- ▶ When the speed limit is intentionally exceeded by stepping on the accelerator pedal all the way down, there is no signal.

Displays in the instrument cluster

Display in the speedometer

Depending on the equipment, a mark in the speedometer displays the status of the system.

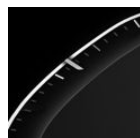

- ▶ Green marking: system is active.
- ▶ Grey marking: system is interrupted.
- ▶ No marking: system is switched off.

Indicator light



- ▶ The indicator light lights up: the system is switched on.
- ▶ The indicator light flashes: the set speed limit has been exceeded.
- ▶ Gray indicator light: the system has been interrupted.

Cruise control

Principle

With the Cruise Control, a set speed can be adjusted using the buttons on the steering wheel. The system maintains the set speed. The system accelerates and brakes automatically as needed.

General information

The system can be activated starting at 20 mph/30 km/h.

Depending on the vehicle setting, the cruise control settings may change under certain conditions. For instance, acceleration can change depending on the driving mode.

Safety information

Warning

The system cannot serve as a substitute for the driver's personal judgment in assessing the traffic situation. Based on the limits of the system, it cannot independently react to all traffic situations. There is a risk of accident. Adjust driving style to traffic conditions. Watch traffic closely and actively intervene where appropriate.

Warning

The use of the system can lead to an increased risk of accidents in the following situations, for instance:

- ▷ On winding roads.
- ▷ In heavy traffic.
- ▷ On slippery roads, in fog, snow, or wet conditions, or on a loose road surface.

There may be a risk of accident or risk of damage to property. Only use the system if driving at constant speed is possible.

Warning

The set speed can be incorrectly adjusted or called up by mistake. There is a risk of accident. Adjust the set speed to the traffic conditions. Watch traffic closely and actively intervene where appropriate.

Overview

Buttons on the steering wheel

Button Function



Cruise control on/off.



Continue cruise control with the last setting.



Pause cruise control.



Store current speed.
Speed Limit Assistant: accept suggested speed manually.



Rocker switch:
Set speed.

Switching cruise control on/off

Turning on



Depending on the equipment version, press the relevant button on the steering wheel.



The indicator lights in the instrument cluster light up and the marking on the speedometer is set to the current speed.

Cruise control is active. The current speed is maintained and stored as set speed.

DSC Dynamic Stability Control is switched on, if necessary.

Turning off



Depending on the equipment version, press the relevant button on the steering wheel.



The displays turn off. The stored set speed is deleted.

Pausing cruise control

Interrupting manually



When active, press the button.

Interrupting automatically

The system is automatically interrupted in the following situations, for example:

- ▶ When braking manually.
- ▶ Steptronic transmission: gear lever position D is disengaged.
- ▶ Dynamic Traction Control DTC is activated or DSC Dynamic Stability Control is deactivated.
- ▶ The Dynamic Stability Control (DSC) adjusts.

Setting the speed

Maintaining and storing the speed

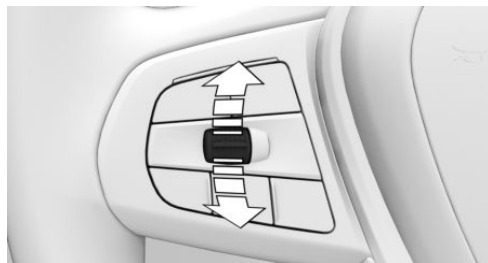

Press the rocker switch up or down once while the system is interrupted.

When the system is switched on, the current speed is maintained and stored as the set speed. The stored speed is displayed on the speedometer.

DSC Dynamic Stability Control is switched on, if necessary.

The speed can also be stored by pressing a button.



Press the button.

Changing the speed



Press the rocker switch up or down repeatedly until the desired speed is set.

If active, the displayed speed is stored and the vehicle reaches the stored speed when the road is clear.

- ▶ Each time the rocker switch is tapped to the resistance point, the set speed increases or decreases by 1 mph/1 km/h.
- ▶ Each time the rocker switch is pressed past the resistance point, the desired speed changes by a maximum of 5 mph/10 km/h. The maximum speed that can be set depends on the vehicle.
- ▶ Pressing the rocker switch to the resistance point and holding it: vehicle accelerates or decelerates without pressure on the accelerator pedal.

After the rocker switch is released, the vehicle maintains its final speed. Pressing the switch beyond the resistance point causes the vehicle to accelerate more rapidly.

Continuing cruise control

An interrupted cruise control can be continued by calling up the stored speed.

Make sure that the difference between current speed and stored speed is not too large before calling up the stored speed. Otherwise, unintentional deceleration or acceleration may occur.

 Press the button with the system interrupted.

Cruise control is continued with the stored values.

In the following cases, the stored speed value is deleted and cannot be called up again:

- ▷ When the system is switched off.
- ▷ When drive-ready state is switched off.

Displays in the instrument cluster

Display in the speedometer

Depending on the equipment, a mark in the speedometer displays the status of the system.

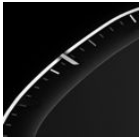

- ▷ Green marking: system is active, the marking indicates the desired speed.
- ▷ Grey marking: system is interrupted, the marking indicates the stored speed.
- ▷ No marking: system is switched off.

Indicator light



- ▷ Indicator light green: system is active.
- ▷ Gray indicator light: the system has been interrupted.
- ▷ No indicator light: system is switched off.

Displays in the Head-up Display

Some system information can also be displayed in the Head-up Display.



The icon is displayed when the set speed is reached.

System limits

The set speed is also maintained downhill. The speed may not be maintained on uphill grades if the drive power is insufficient.

In ECO PRO driving mode, the vehicle may exceed or drop below the set desired speed in some situations, for instance on downhill or uphill grades.

Active Cruise Control with Stop&Go function ACC

Principle

Using the Cruise Control, a desired speed and a distance to a vehicle ahead can be adjusted using the buttons on the steering wheel.

General information

The system maintains the set speed on clear roads. The vehicle accelerates or brakes automatically.

If a vehicle is driving ahead of you, the system adjusts the speed of your vehicle so that the set distance to the vehicle ahead is maintained. The speed is adjusted as far as the given situation allows.

The distance can be adjusted in several steps. For safety reasons, it depends on the respective speed.

If the vehicle ahead of you brakes to a halt, and then proceeds to drive again within a brief period, the system is able to detect this within the given system limits.

Depending on the vehicle setting, the cruise control settings may change under certain conditions. For instance, acceleration can change depending on the driving mode.

Safety information

Warning

The system cannot serve as a substitute for the driver's personal judgment in assessing the traffic situation. Based on the limits of the system, it cannot independently react to all traffic situations. There is a risk of accident. Adjust driving style to traffic conditions. Watch traffic closely and actively intervene where appropriate.

Warning

An unsecured vehicle can begin to move and possibly roll away. There is a risk of accident. Before exiting, secure the vehicle against rolling.

In order to ensure that the vehicle is secured against rolling away, follow the following:

- ▷ Set the parking brake.
- ▷ On uphill grades or on a downhill slope, turn the front wheels in the direction of the curb.
- ▷ On uphill grades or on a downhill slope, also secure the vehicle, for instance with a wheel chock.

Warning

The set speed can be incorrectly adjusted or called up by mistake. There is a risk of accident. Adjust the set speed to the traffic conditions. Watch traffic closely and actively intervene where appropriate.

Warning

Risk of accident due to too high speed differences to other vehicles, for instance in the following situations:

- ▷ When fast approaching a slowly moving vehicle.
- ▷ Vehicle suddenly swerving into own lane.
- ▷ When fast approaching standing vehicles.

There is a risk of injury or danger to life. Watch traffic closely and actively intervene where appropriate.

Overview

Buttons on the steering wheel

Button Function



With steering and traffic jam assistant:
Cruise control on/off.



With steering and traffic jam assistant:
Select function.



Without steering and traffic jam assistant:
Cruise control on/off.



Store current speed.
Speed Limit Assistant: accept suggested speed manually.



With steering and traffic jam assistant:
Pause cruise control.
Continue cruise control with the last setting.



Without steering and traffic jam assistant:
Continue cruise control with the last setting.



Without steering and traffic jam assistant:
Pause cruise control.



Increase the distance.
Switch distance control on/off.

Button Function

Reduce distance.
Switch distance control on/off.



Rocker switch:
Set speed.

Sensors

The system is controlled by the following sensors:

- ▷ Cameras behind the windshield.
- ▷ Front radar sensor.

Additional information:

Sensors of the vehicle, refer to page 37.

Application range

The system is best used on well-constructed roads.

The minimum speed that can be set is 20 mph/30 km/h.

The maximum speed that can be set is limited and, e.g., depends on the vehicle and the vehicle equipment.

The system can also be activated when stationary.

Turning on/off and interrupting cruise control**With steering and traffic jam assistant: Assisted Driving Mode****General information**

This button is used to switch the configured function on and off.



The button can be used to set the primarily used function.

Set function

When the system is active, press the button repeatedly until the desired function is selected in the toolbar. The toolbar for Assisted Driving mode is displayed at the bottom of the instrument cluster.

Icon Function

Cruise control with distance control.





Depending on the equipment version, cruise control with distance control and steering and traffic jam assistant.



The selected function is shown in green.

Turning on

With steering and traffic jam assistant:

1.  Press the button on the steering wheel.
2.  If necessary, set the cruise control.

Without steering and traffic jam assistant:

1.  Press the button on the steering wheel.

The indicator lights in the instrument cluster light up and the marking on the speedometer is set to the current speed.

Cruise control is active. The current speed is maintained and stored as set speed.

DSC Dynamic Stability Control is switched on, if necessary.

Turning off

To switch off the system while standing, step on brake pedal at the same time.

Press the button on the steering wheel:



With steering and traffic jam assistant.



Without steering and traffic jam assistant.

The displays turn off. The stored set speed is deleted.

Interrupting manually

When active, press the button on the steering wheel:



With steering and traffic jam assistant.



Without steering and traffic jam assistant.

If interrupting the system while stationary, press on the brake pedal at the same time.

Interrupting automatically

The system is automatically interrupted in the following situations:

- ▶ When the driver applies the brakes.
- ▶ When selector lever position D is disengaged.
- ▶ Dynamic Traction Control DTC is activated or DSC Dynamic Stability Control is deactivated.
- ▶ If DSC Dynamic Stability Control intervenes.
- ▶ If the safety belt and the driver's door are opened while the vehicle is standing still.
- ▶ If the system has not detected objects for an extended period, for instance on a road with very little traffic without curb or shoulder markings.
- ▶ If the detection range of the radar is impaired, for instance by contamination or heavy precipitation.
- ▶ After a longer stationary period when the vehicle has been braked to a stop by the system.

Setting the speed

Maintaining and storing the speed

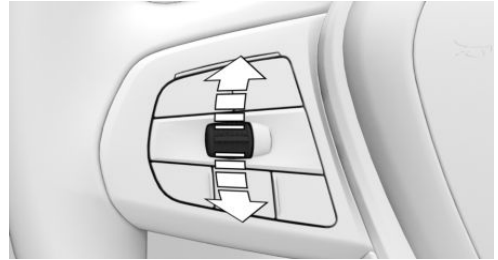

Press the rocker switch up or down once while the system is interrupted. The system will be activated.

The current speed is maintained and stored as desired speed.

The stored speed is displayed on the speedometer.

DSC Dynamic Stability Control is switched on, if necessary.

The speed can also be stored by pressing a button.



Press the button.

Changing the speed

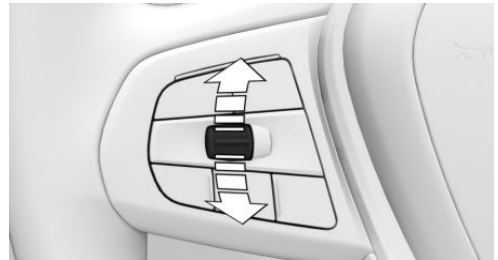

Press the rocker switch up or down repeatedly until the desired speed is set.

If active, the displayed speed is stored and the vehicle reaches the stored speed when the road is clear.

- ▷ Each time the rocker switch is tapped to the resistance point, the set speed increases or decreases by 1 mph/1 km/h.
- ▷ Each time the rocker switch is pressed past the resistance point, the desired speed changes by a maximum of 5 mph/10 km/h.

Hold the rocker switch in position to repeat the action.

Adjusting the distance

Safety information

Warning

The system cannot serve as a substitute for the driver's personal judgment. Due to the system limits, deceleration can be late. There may be a risk of accident or risk of damage to property. Be aware to the traffic situation at all times. Adjust the distance to the traffic and weather conditions and maintain the prescribed safety distance, possibly by braking.

Reduce distance



Press the button repeatedly until the desired distance is set.

Instrument cluster will display selected distance.

Increase the distance



Press the button repeatedly until the desired distance is set.

Instrument cluster will display selected distance.

Automatic adaptation of the distance

Depending on the equipment and national-market version: the system can be adjusted so that the distance to the vehicle driving in front is automatically adjusted within the configured distance

according to the traffic situation or the ambient conditions, for instance poor visibility.

1. "CAR"
2. "Settings"
3. "Driver Assistance"
4. If necessary, "Driving"
5. "Speed Limit Assistance"
6. "Adjust distance acc. to situation"

Continuing cruise control

An interrupted cruise control can be continued by calling up the stored speed.

Make sure that the difference between current speed and stored speed is not too large before calling up the stored speed. Otherwise, unintentional deceleration or acceleration may occur.

Press the button on the steering wheel with the system interrupted:



With steering and traffic jam assistant.



Without steering and traffic jam assistant.

Cruise control is continued with the stored values.

In the following cases, the stored speed value is deleted and cannot be called up again:

- ▷ When the system is switched off.
- ▷ When drive-ready state is switched off.

Changing between cruise control with/without distance control



Safety information

Warning

The system does not react to traffic driving ahead of you, but instead maintains the stored speed. There may be a risk of accident or risk of damage to property. Adjust the set speed to the traffic conditions and brake as needed.

Change over mode of the cruise control

Switching cruise control without distance control off and on:

- >  Press and hold this button.
- >  Press and hold this button.

With steering and traffic jam assistant: switch on distance control:

-  Press the button.

Without steering and traffic jam assistant: switch on distance control:

- >  Press the button.
- >  Press the button.

After changing, a Check Control message is displayed.

Displays in the instrument cluster

General information

Depending on the equipment version, the displays in the instrument cluster may vary.

Display in the speedometer

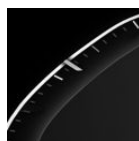

Depending on the equipment, a mark in the speedometer displays the status of the system.



- > Green marking: system is active, the marking indicates the desired speed.
- > Grey marking: system is interrupted, the marking indicates the stored speed.
- > No marking: system is switched off.

Distance to vehicle ahead of you

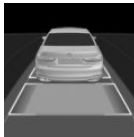
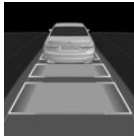
Selected distance to the vehicle ahead of you is shown.

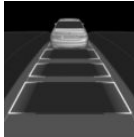
| Icon | Description |
|---|--|
|  | Distance 1 |
|  | Distance 2 |
|  | Distance 3 |
|  | Distance 4 This value is set automatically after the system is switched on. |
|  | No distance control display, as the accelerator pedal is being pressed. |

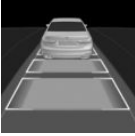

Detected vehicle



| Icon | Description |
|--|--|
|  | Green icon: A vehicle has been detected ahead of you. |

When the distance to the detected vehicle increases, the vehicle symbol in the distance display will move away.





If necessary, independent drive-off, such as by stepping on the accelerator pedal or by pressing the rocker switch.

Indicator/warning lights

| Icon | Description |
|--|---|
|  | Vehicle symbol white: No distance control display, as the accelerator pedal is being pressed. |
|  | Green icon: A vehicle has been detected ahead of you. The vehicle symbol goes out if no vehicle in front is detected. Vehicle symbol flashes green: Vehicle in front drove off. |
|  | Gray icon: System interrupted. |

| Icon | Description |
|---|---|
|  | Symbol flashes gray: The conditions are not adequate for the system to work. The system was deactivated but applies the brakes until you actively resume control by pressing on the brake pedal or accelerator pedal. |
|  | Vehicle symbol flashes red and a signal sounds: Brake and make an evasive maneuver, if necessary. |

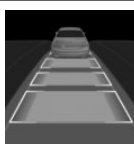
Alternative displays

| Icon | Description |
|---|--|
|  | Indicator light green: system is active. No indicator light: system is switched off. |
|  | Vehicle symbol flashes: The conditions are not adequate for the system to work. The system was deactivated but applies the brakes until you actively resume control by pressing on the brake pedal or accelerator pedal. |
|  | The vehicle symbol and distance bars blink red and an acoustic signal sounds: Brake and make an evasive maneuver, if necessary. |
|  | System interrupted. |

Displays in the Head-up Display

Set speed

Some system information can also be displayed in the Head-up Display.



The icon is displayed when the set speed is reached.

Distance information



The icon is displayed when the distance from the vehicle traveling ahead is too short.

The distance information is active in the following situations:

- ▷ Active Cruise Control switched off.
- ▷ Display in the Head-up Display selected. Head-Up Display, refer to page 168.
- ▷ Distance too short.
- ▷ Speed greater than approx. 40 mph/70 km/h.

System limits

System limits of the sensors

Additional information:

- ▷ Cameras, refer to page 37.
- ▷ Radar sensors, refer to page 38.

Detection range

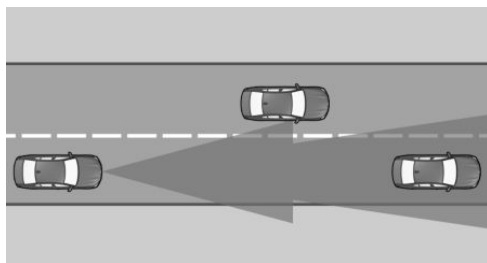

The detection capability of the system and the automatic braking performance are limited.

Two-wheeled vehicles for instance might not be detected.

Deceleration

The system does not decelerate in the following situations:

- ▷ For pedestrians or similarly slow-moving road users.
- ▷ Depending on the equipment, with red traffic lights.
- ▷ For cross traffic.
- ▷ For oncoming traffic.

Merging vehicles

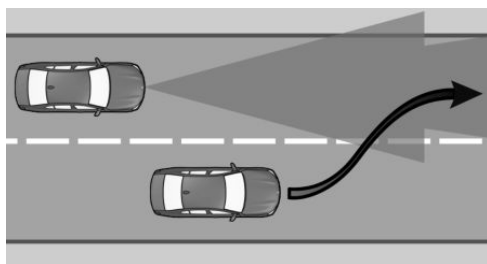

If a vehicle driving ahead of you suddenly merges into your lane, the system may not be able to automatically restore the selected distance. It may not be possible to restore the selected distance in certain situations, including if you are driving significantly faster than vehicles driving ahead of you, for instance when rapidly approaching a truck. When a vehicle driving ahead of you is reliably detected, the system requests that the driver intervene by braking and carrying out evasive maneuvers, if needed.

Cornering

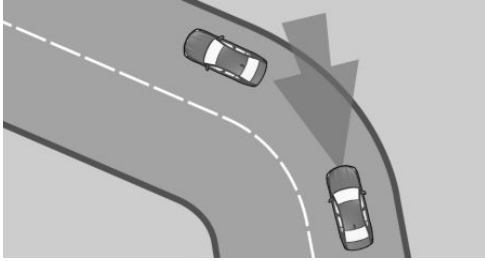

When the set speed is too high for a curve, the speed is reduced slightly. Because curves may not be anticipated in advance, drive into a curve at an appropriate speed.

The system has a limited detection range. Situations can arise in tight curves where a vehicle driving ahead will not be detected or will be detected very late.

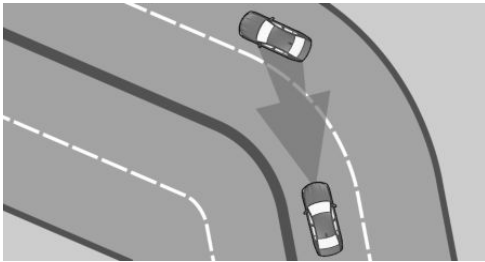

When you approach a curve the system may briefly report vehicles in the next lane due to the bend of the curve. If the system decelerates you may compensate it by briefly accelerating. After releasing the accelerator pedal the system is re-activated and controls speed independently.

Driving off

In some situations, the vehicle cannot drive off automatically; for example:

- ▷ On steep uphill grades.
- ▷ In front of bumps in the road.

In these cases, step on the accelerator pedal.

Weather

The following restrictions can occur under unfavorable weather or light conditions:

- ▷ Poorer vehicle detection.
- ▷ Short-term interruptions for vehicles that are already recognized.

Drive attentively, and react to the current traffic situation. If necessary, intervene actively, for instance by braking, steering or evading.

Drive power

The set speed is also maintained downhill. The speed may not be maintained on uphill grades if the drive power is insufficient.

In ECO PRO driving mode, the vehicle may exceed or drop below the set desired speed in some situations, for instance on downhill or uphill grades.

Speed Limit Assistant

Principle

Speed Limit Assistant supports driving at the speed limit. A suggested speed can be applied.

General information

When the systems in the vehicle, e.g., Speed Limit Info, detect a change of the speed limit, this new speed value can be applied for the following systems:

- ▷ Manual Speed Limiter.
- ▷ Cruise control.
- ▷ Active Cruise Control with Stop&Go function ACC.

The speed value is suggested as the new desired speed to be applied. To apply the speed value, the corresponding system must be activated.

Safety information

Warning



The system cannot serve as a substitute for the driver's personal judgment in assessing the traffic situation. Based on the limits of the system, it cannot independently react to all traffic situations. There is a risk of accident. Adjust driving style to traffic conditions. Watch traffic closely and actively intervene where appropriate.

Warning

The set speed can be incorrectly adjusted or called up by mistake. There is a risk of accident. Adjust the set speed to the traffic conditions. Watch traffic closely and actively intervene where appropriate.

Overview

Buttons on the steering wheel

| Button | Function |
|--|---|
|  | Accept suggested speed manually. |
|  | Rocker switch: Set speed, refer to Cruise Control. |



Turning Speed Limit Assistant on/off

1. "CAR"
2. "Settings"
3. "Driver Assistance"
4. If necessary, "Driving"
5. "Speed Limit Assistance"
6. "Speed limits"
7. Select the desired setting:

- ▷ "Adjust manually": detected speed limits can be applied manually.
- ▷ "Show anticipation": current and upcoming speed limits are displayed in the instrument cluster without being applied.
- ▷ "Show current limit": current speed limits are displayed without being applied in the instrument cluster.
- ▷ "Off": depending on the national-market version, Speed Limit Info and Speed Limit Assistant will be turned off.

Displays in the instrument cluster

A message is displayed in the instrument cluster when the system and a driver assistance system are activated.

| Icon | Function |
|---|---|
|  | Depending on the equipment version, the indicator light illuminates green, together with the icon for a cruise control system: Speed Limit Assistant is active and detected speed limits can be applied manually for the displayed system. |
|  | Detected change of a speed limit with immediate effect. |
|  | Indicator light illuminates green: the detected speed limit can be applied with the SET button. After it has been applied, a green checkmark is displayed. |

Manual adoption

A detected speed limit can be applied manually for the active driver assistance system.

- | | |
|---|--|
|  | When the SET icon lights up, press the button. |
|---|--|

Adapt to route

Principle

The system can be configured so that the vehicle adapts the speed automatically to the route.

For instance, the speed will be reduced in the following situations, if necessary:

- ▷ Before making turns.
- ▷ Before a roundabout.
- ▷ Before a curve.

Adjustment

1. "CAR"
2. "Settings"
3. "Driver Assistance"
4. If necessary, "Driving"
5. "Speed Limit Assistance"
6. "Adjust to route" or "Automatically adjust speed to route"

System limits

Speed Limit Assistant is based on the Speed Limit Info system.

Consider the system limits of Speed Limit Info.

Upcoming speed limits can only be applied for the Active Cruise Control ACC.

Depending on the national-market version, the system may not respond at all or with limitations to the route when the navigation system is unable to clearly identify the position of the vehicle.

Additional information:

- ▷ System limits of Speed Limit Information, refer to page 165.
- ▷ System limits of the sensors, refer to page 37.

Steering Assistant

Principle

The Steering Assistant helps keep the vehicle in the lane. For this purpose, the system executes supporting steering movements, for instance when driving in a curve.

General information

Depending on the speed, the system orients itself according to the lane markings or vehicles in front.

Sensors on the steering wheel detect whether the steering wheel is being touched.



Safety information

Warning

The system cannot serve as a substitute for the driver's personal judgment in assessing the traffic situation. Based on the limits of the system, it cannot independently react to all traffic situations. There is a risk of accident. Adjust driving style to traffic conditions. Watch traffic closely and actively intervene where appropriate.

Overview

Buttons on the steering wheel

| Button | Function |
|---|--|
|  | Steering and traffic jam assistant incl. Traffic Jam Assistant on/off. |
|  | Switch function on. |

Sensors

The system is controlled by the following sensors:

- ▷ Cameras behind the windshield.
- ▷ Front radar sensor.
- ▷ Radar sensors, side, front.
- ▷ Radar sensors, side, rear.

Additional information:

Sensors of the vehicle, refer to page 37.

Functional requirements

- ▷ Speed below 130 mph/210 km/h.
- ▷ Sufficient lane width.
- ▷ Above approx. 43 mph, 70 km/h: lane marking on both sides is detected.
- ▷ Below approx. 43 mph, 70 km/h: lane marking on both sides or a vehicle driving ahead is detected.
- ▷ Hands on the steering wheel rim.
- ▷ Wide curves.
- ▷ Drive in the center of the lane.
- ▷ Turn signal switched off.
- ▷ The sensor system calibration process is complete.
- ▷ Cruise control with distance control active.
- ▷ Safety belt on the driver's side fastened.
- ▷ Forward Collision Warning active.
- ▷ Pedestrian Warning active.
- ▷ Side Collision Warning active.

Turning on/off

Assisted Driving Mode

General information

 This button is used to switch the configured function on and off.

 The button can be used to set the primarily used function.

Set function



 When the system is active, press the button repeatedly until the desired function is selected in the toolbar. The toolbar for Assisted Driving mode is displayed at the bottom of the instrument cluster.

| Icon | Function |
|---|--|
|  | Cruise control with distance control. |
|  | Depending on the equipment version, cruise control with distance control and steering and traffic jam assistant. |
|  | |



The selected function is shown in green.

Turning on

1.  Press the button on the steering wheel.
2.  Adjust the steering and traffic jam assistant if necessary.

 Steering wheel symbol lights up gray.
The system is on standby and does not manipulate steering.

System activates automatically as soon as all function conditions are fulfilled.

 Steering wheel symbol lights up green.
The system is active.

With the system switched on, the Pedestrian Warning with City Collision Mitigation and the side collision mitigation are active.

Turning off

 Press the button on the steering wheel.
The indicator goes out.

The system does not perform supportive steering wheel movements.

Interrupting automatically

The system interrupts the supporting steering movements automatically, for example in the following situations:



- ▷ At a speed above 130 mph/210 km/h.
- ▷ When the steering wheel is released.
- ▷ When the driver applies the brakes.
- ▷ When you manipulate steering.
- ▷ When leaving own lane.
- ▷ When the turn signal is switched on.
- ▷ When the lane is too narrow.
- ▷ If a lane boundary is not detected for a certain period of time and no vehicle is driving ahead.
- ▷ The Active Cruise Control ACC is interrupted.
- ▷ The safety belt on the driver's side is unfastened.







Steering wheel symbol lights up gray.
The system is on standby and does not manipulate steering.

System activates automatically as soon as all function conditions are fulfilled.



Displays in the instrument cluster







| Icon | Description |
|--|--|
|  | Gray steering wheel symbol: The system is on standby. |
|  | Green steering wheel symbol: The system is activated. The system supports the driver in keeping the vehicle within the lane. |

| Icon | Description |
|---|--|
|  | Yellow flashing steering wheel symbol: Lane marking driven over. The steering wheel vibrates where applicable. |
|  | Yellow steering wheel symbol and a signal sounds, if applicable: System interruption is imminent. |
|  | Steering wheel symbol blinks red, signal sounds: System is switching off. |
|  | Yellow steering wheel symbol: The hands are not grasping the steering wheel. The system is still active. |
|  | Red steering wheel symbol and a signal sounds: The hands are not grasping the steering wheel. System interruption is imminent. The system reduces the speed to a standstill if applicable. It is possible that the system will not execute any supporting steering movements. |

Alternative displays

Depending on the equipment version, the displays in the instrument cluster may vary and are displayed as follows:

| Icon | Description |
|---|--|
|  | Gray steering wheel symbol: The system is on standby. |
|  | Green steering wheel symbol: The system is activated. |

| Icon | Description |
|--|---|
|  | Depending on equipment, yellow flashing steering wheel symbol: Lane marking driven over. The steering wheel vibrates where applicable. |
|  | Yellow steering wheel symbol and a signal sounds, if applicable: System interruption is imminent. |
|  | Depending on equipment, steering wheel symbol flashes red, signal sounds: System is switching off. |
|  | Green steering wheel icon and lane marking icon: The system supports the driver in keeping the vehicle within the lane. |
|  | Yellow steering wheel symbol: The hands are not grasping the steering wheel. The system is still active. |
|  | Red steering wheel symbol and a signal sounds: The hands are not grasping the steering wheel. System interruption is imminent. It is possible that the system will not execute any supporting steering movements. With Active Cruise Control, the system may reduce the speed. |

Displays on the steering wheel



The two LED lights above the buttons illuminate analogously to the displays in the instrument cluster:

- ▷ Yellow: system interruption is imminent.
- ▷ Red: system will be deactivated.

The steering wheel displays can be switched on/off if required.

1. "CAR"
2. "Settings"
3. "Driver Assistance"
4. "Steering Wheel Feedback"
5. "Light elements"

Displays in the Head-up Display

All system information can also be displayed in the Head-up Display.

System limits

General information

The system cannot be activated or meaningfully used in certain situations.

Safety information

Warning

The system is designed to operate in certain conditions and circumstances. Due to conditions or other factors, the system may not respond. There may be a risk of accident or risk of damage to property. Actively intervene as

warranted. Refer to the information in this Owner's Manual regarding the scope of the system's operation and limitations.

System limits of the sensors

Additional information:

- ▷ Cameras, refer to page 37.
- ▷ Radar sensors, refer to page 38.

Hands on the steering wheel

The sensors cannot detect hand-steering wheel contact in the following situations:

- ▷ Driving with gloves.
- ▷ Protective covers on the steering wheel.

Narrow lanes

When driving within narrow lanes, the system cannot be activated or effectively used, for instance in the following situations:

- ▷ In construction areas.
- ▷ Depending on the equipment, with automatic formation of emergency lanes.
- ▷ Within city limits.

Weather

The following restrictions can occur under unfavorable weather or light conditions:

- ▷ Poorer recognition of vehicles and lane markings.
- ▷ Short-term interruptions for vehicles that are already recognized.

Drive attentively, and react to the current traffic situation. If necessary, intervene actively, for instance by braking, steering or evading.

Extended Traffic Jam Assistant

Principle

Extended Traffic Jam Assistant supports the driver with vehicle control in traffic jam situations.

Supporting steering movements take place without the driver actively steering.

General information

The system uses the sensors of the steering and lane control assistant.

Safety information

Warning

The system cannot serve as a substitute for the driver's personal judgment in assessing the traffic situation. Based on the limits of the system, it cannot independently react to all traffic situations. There is a risk of accident. Adjust driving style to traffic conditions. Watch the traffic situation closely, be ready to take over steering and braking at any time, and actively intervene where appropriate.

State laws differ and the use of this function may violate the law. Before use, check your state and local laws.

Additionally, the notices for the Steering and Lane Control Assistant apply.

Additional information:

Steering and Lane Control Assistant, refer to page 230.

Functional requirements

- ▷ The functional requirements of the steering and traffic jam assistant are fulfilled.
Functional requirements, refer to page 231.
- ▷ The steering and traffic jam assistant is active.

- ▷ The function is only available on certain street types, e.g. freeways.
- ▷ Driving on a road without pedestrians or cyclists.
- ▷ Sufficient lane width.
- ▷ Lane markings and a vehicle driving ahead are detected.
- ▷ Speed less than approx. 40 mph/60 km/h.
- ▷ The Driver Attention Camera in the instrument cluster detects that the driver is paying attention to the traffic.
- ▷ The function must be available in the country in which the vehicle is driven.

Turning on



As soon as all functional requirements are met, Extended Traffic Jam Assistant will be displayed as an additional icon in the toolbar. The toolbar is displayed at the bottom of the instrument cluster.



Select Extended Traffic Jam Assistant with the button on the steering wheel.

The icon for Extended Traffic Jam Assistant is shown in green.

Two green LED lights are illuminated on the steering wheel.

The indicator light in the instrument cluster is shown in green.

The system begins to assist the driver with vehicle control.

Displays in the instrument cluster

| Icon | Description |
|------|--|
| | Indicator light green: system is active. |
| | Indicator light white: system is ready. |
| | Gray indicator light: the system has been interrupted. |

Alternative displays

Depending on the equipment version, the displays in the instrument cluster may vary and are displayed as follows:

| Indicator light | Description |
|-----------------|--|
| | Indicator light green: system is active. |

Displays on the steering wheel



The two LED lights above the buttons illuminate analogously to the displays in the instrument cluster:

- ▷ Green: the system is active.
- ▷ Yellow: system will be interrupted.
- ▷ Red: system will be deactivated.

System limits

General information

The limits of the Steering and Lane Control Assistant system apply.

Additional information:

Steering and Lane Control Assistant, refer to page 230.

Driver Attention Camera

Always monitor the traffic conditions.

The Driver Attention Camera detects whether or not the driver is paying attention to the traffic conditions.

The Driver Attention Camera may not be fully functional in the following situations:

- ▷ When the Driver Attention Camera is covered by the steering wheel.
- ▷ With sunglasses with high protection from infrared light.

Depending on the equipment version: Automatic Lane Change Assistant

Principle

The system additionally supports the driver when changing lanes on multilane roads.

General information

The system uses the sensors of the steering and lane control assistant.

Safety information

Warning

The system cannot serve as a substitute for the driver's personal judgment in assessing the traffic situation. Based on the limits of the system, it cannot independently react to all traffic situations. There is a risk of accident. Adjust driving style to traffic conditions. Watch traffic closely and actively intervene where appropriate.

Additionally, the notices for the Steering and Lane Control Assistant apply.

Additional information:

Steering and Lane Control Assistant, refer to page 230.

Functional requirements

- ▷ The functional requirements of the steering and traffic jam assistant are fulfilled.
 - Functional requirements, refer to page 231.
- ▷ Driving on a road without pedestrians or cyclists and with physical barriers to oncoming traffic, such as crash barriers.
- ▷ Lane markings have been detected.
- ▷ Maximum speed approx. 110 mph, 180 km/h.
- ▷ The minimum speed is country-specific.

Switch lane change assist on/off

1. "CAR"
2. "Settings"
3. "Driver Assistance"
4. If necessary, "Driving"
5. "Steering Assistance"
6. "Automatic Lane Change"

Changing lanes

1. Ensure that the traffic situation permits changing lanes.
2. Press the turn signal lever in the required direction to the pressure point for signaling briefly.

A supporting steering movement in the required direction can be detected a short time later.

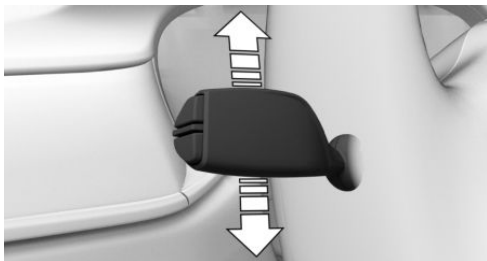



After the lane change, the system helps keep the vehicle in the new lane.

Canceling a lane change

The lane change can be canceled by steering movement into the opposite direction.

Displays in the instrument cluster

| Icon | Description |
|---|--|
|  | Green steering wheel symbol. Green arrow symbol for lane-changing. The system carries out a lane change. |
|  | Green steering wheel symbol. Gray line for lane marking on the appropriate side. The system detected the lane change request. Lane change not currently possible. |
|  | Depending on country specifications: Green steering wheel symbol. Gray arrow symbol for lane-changing. Lane change not possible; functional requirements not met. |

Alternative displays

Depending on the equipment version, the displays in the instrument cluster may vary and are displayed as follows:

| Icon | Description |
|------|-------------|
|------|-------------|



Green steering wheel symbol.
 Gray line for lane marking on the appropriate side.
 Green arrow symbol for lane-changing.
 The system carries out a lane change.



Green steering wheel symbol.
 Gray line for lane marking on the appropriate side.
 No arrow symbol for lane-changing on the display.
 The system detected the lane change request. Lane change not currently possible.



Depending on country specifications:
 Green steering wheel symbol.
 Gray line for lane marking on the appropriate side.
 Gray arrow symbol for lane-changing.
 Lane change not possible; functional requirements not met.

System limits

The limits of the Steering and Lane Control Assistant system apply.

Additional information:

Steering and Lane Control Assistant, refer to page [230](#).

Depending on the equipment version: lane change with active guidance

Principle

The system assists the driver when lane changes are necessary to reach a navigation destination.

General information

The system uses the sensors of the steering and lane control assistant.

Safety information

Warning

The system cannot serve as a substitute for the driver's personal judgment in assessing the traffic situation. Based on the limits of the system, it cannot independently react to all traffic situations. There is a risk of accident. Adjust driving style to traffic conditions. Watch traffic closely and actively intervene where appropriate.

Additionally, the notices for the Active Cruise Control and the Steering and Lane Control Assistant apply.

Additional information:

- ▶ Active Cruise Control, refer to page [220](#).
- ▶ Steering and Lane Control Assistant, refer to page [230](#).

Functional requirements

- ▶ Active Cruise Control is activated.
- ▶ Driving on a highway or highway-like road.
- ▶ Lane markings on the side of the desired lane change detected.
- ▶ Navigation system: guidance is activated.

- Adaptation to the course of the route is activated.
- The function must be available in the country in which the vehicle is driven.

Changing lanes

1. One or more lane changes are required to reach a navigation destination.

The system prepares for this lane change. For this purpose, the system determines a suitable opening in the traffic flow on the next lane.

2. When a gap is detected, the speed is adapted so that the vehicle remains at the level of the opening.
3. A Check Control message indicates a lane change suggestion.

When Steering Assistant is active, a steering intervention in the direction of the relevant lane may occur.

4. When the traffic situation permits a lane change, the driver can steer the vehicle into the next lane.

When equipped with Automatic Lane Change Assistant: after the Check Control message has been displayed, the Automatic Lane Change Assistant can be started by operating the turn signal.

Display in the instrument cluster

| Icon | Function |
|--|--|
|  | The suggestion for the lane change is displayed and a green checkmark indicates the active function. |

Depending on the equipment and national-market version, the traffic situation is displayed in the Assisted Driving View of the instrument cluster.

Additional information:

Assisted Driving View, refer to page 149.

Turn on adaptation to the course of the route

1. "CAR"
2. "Settings"
3. "Driver Assistance"
4. If necessary, "Driving"
5. "Speed Limit Assistance"
6. "Adjust to route" or "Automatically adjust speed to route"

System limits

The limits of the Active Cruise Control and Steering and Lane Control Assistant systems apply.

Parking assistance systems

Principle

The parking assistance systems support the driver in parking and maneuvering.

General information

The parking assistance systems comprise the following individual systems.

Additional information:

- PDC Park Distance Control, refer to page 240.
- Depending on equipment version: emergency brake function, Active PDC, refer to page 243.
- Side parking aid, refer to page 243.
- Without Surround View: rearview camera, refer to page 244.
- Automatic Parking Assistant, refer to page 247.
- Automatic Parking Assistant, driving out of parking space, refer to page 251.
- Back-up Assistant, refer to page 252.

- ▷ Surround View with rearview camera, refer to page 254.
- ▷ Panorama View, refer to page 259.
- ▷ Remote 3D View, refer to page 261.
- ▷ Cross traffic warning, refer to page 262.

PDC Park Distance Control

Principle

Park Distance Control (PDC) helps with parking. Acoustic and visual warnings signal obstacles in front of or behind the vehicle.

Depending on the equipment version: obstacles that are detected by the side ultrasonic sensors may also be reported by the side protection.

General information

The range of the system, depending on obstacles and environmental conditions, is approx. 6 ft/2 m.

An acoustic warning sounds in case of an impending collision at a distance to the object of approx. 27 in/70 cm.

For objects behind the vehicle, the acoustic warning is already issued at a distance to the object of approx. 5 ft/1.50 m.

Safety information

Warning

The system cannot serve as a substitute for the driver's personal judgment in assessing the traffic situation. Based on the limits of the system, it cannot independently react to all traffic situations. There is a risk of accident. Adjust driving style to traffic conditions. Watch traffic closely and actively intervene where appropriate.

Warning

Due to high speeds when PDC Park Distance Control is activated, the warning can be delayed due to physical circumstances. There is a risk of injury or risk of damage to property. Avoid approaching an object too fast. Avoid driving off fast while PDC Park Distance Control is not yet active.

Overview

Button in the vehicle



 Park assistance button

Sensors

The system is controlled by the following sensors:

- ▷ Ultrasound sensors in the front/rear bumpers.
- ▷ Depending on the equipment: ultrasonic sensors on the side.

Additional information:

Sensors of the vehicle, refer to page 37.

Turning on/off

Turning on automatically

The system switches on automatically in the following situations:

- ▶ If selector lever position R is engaged when the engine is running.
- ▶ Depending on the equipment version: while approaching detected obstacles at a speed slower than approx. 2.5 mph/4 km/h. The activation distance depends on the situation in question.

You may switch automatic activation when obstacles are detected on and off.

1. "CAR"
2. "Settings"
3. "Driver Assistance"
4. "Parking and Maneuvering"
5. If necessary, "Automatic PDC Activation"
6. "Automatic PDC Activation"

Depending on equipment, an additional camera view is also switched on.

Automatic deactivation during forward travel

The system switches off when a certain driving distance or speed is exceeded.

Switch the system back on, if needed.

Switching on/off manually



Press the park assistance button.

- ▶ On: the LED lights up.
- ▶ Off: the LED goes out.

The rearview camera image is displayed if the reverse gear is engaged when pressing the park assistance button.

Depending on the equipment version, the system cannot be switched off manually if the reverse gear is engaged.

Warning

Signal tones

General information

An intermittent tone indicates when the vehicle is approaching an object. E.g., when an object is detected at the rear left of the vehicle, a signal tone sounds from the rear left speaker.

The shorter the distance to the object, the shorter the intervals.

When the distance to a detected object is less than approx. 8 in/20 cm, a continuous tone is sounded.

When there are objects in front of and behind the vehicle at the same time, with a distance smaller than approx. 8 in/20 cm, an alternating constant tone will sound.

Steptronic transmission: the intermittent tone and constant tone are switched off if the selector lever position P is engaged.

The intermittent tone is switched off after a short time when the vehicle is stationary.

Volume

The PDC signal tone volume can be adjusted.

1. "CAR"
2. "Settings"
3. "Driver Assistance"
4. "Parking and Maneuvering"
5. "Volume PDC signal"
6. Set the desired value.

Visual warning

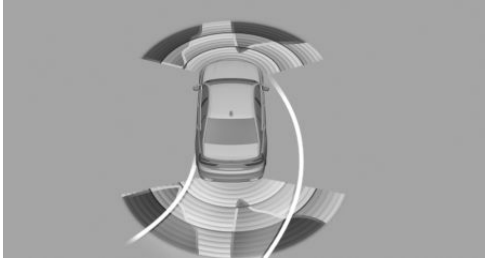

The approach of the vehicle to an object is shown on the Control Display. Objects that are farther away are already displayed on the Control Display before a signal sounds.

The display appears as soon as PDC is activated.

The range of the sensors is represented in the colors green, yellow and red when obstacles are detected.

Lanes are faded in for better estimation of the required space.

When the image of the rearview camera is displayed, the switch can be made to PDC or to a different view with obstacle markings as needed:

1. Press the Controller to the left, if needed.
2. For instance "Park. sensors only"

Cross traffic warning: depending on the equipment, it is warned in the PDC display against vehicles approaching in the front or rear from the side.

Additional information:

Cross traffic warning, refer to page 262.

System limits

Safety information

Warning

The system is designed to operate in certain conditions and circumstances. Due to conditions or other factors, the system may not respond. There may be a risk of accident or risk

of damage to property. Actively intervene as warranted. Refer to the information in this Owner's Manual regarding the scope of the system's operation and limitations.

System limits of the sensors

Additional information:

- ▶ Ultrasonic sensors, refer to page 39.

Limits of ultrasonic measurement

The detection of objects with ultrasonic measurements can run into physical limits, e.g., in the following situations:

- ▶ With obstacles and persons at the edge of the lane.
- ▶ Low objects already displayed, for instance curbs, can move into the blind area of the sensors before or after a continuous tone sounds.

Unwarranted warnings

Reaching the system limits can cause unwarranted warnings.

To prevent unwarranted alarms, switch off automatic Park Distance Control PDC activation on obstacle detection, for instance in automatic car washes.

Malfunction

A Check Control message is displayed.



White icon is displayed, and the range of the sensors is dimmed on the Control Display.

PDC Park Distance Control malfunction. Have the system checked by a dealer's service center or another qualified service center or repair shop.

Depending on equipment version: emergency brake function, Active PDC

Principle

The emergency braking function of PDC initiates an emergency braking in case of acute risk of collision.

General information

Due to system limits, a collision cannot be prevented under all circumstances.

The function is available below walking speed when driving in reverse or rolling backward.

A press of the accelerator pedal interrupts the brake intervention.

After emergency braking to a stop, further creeping toward an obstacle is possible. Proceed with caution. To move forward, lightly press the accelerator pedal and release as needed.

If the accelerator pedal is depressed longer, the vehicle drives off. Manual braking is possible at any time.

The system uses the ultrasonic sensors of the Park Distance Control PDC and the Parking Assistant.

Safety information

Warning

The system cannot serve as a substitute for the driver's personal judgment in assessing the traffic situation. Based on the limits of the system, it cannot independently react to all traffic situations. There is a risk of accident. Adjust driving style to traffic conditions. Watch traffic and vehicle surroundings closely and actively intervene where appropriate.

Additionally, the safety information for the PDC Park Distance Control and the Automatic Parking Assistant apply.

Additional information:

- ▷ PDC Park Distance Control, refer to page 240.
- ▷ Automatic Parking Assistant, refer to page 247.

Temporary switching off

The emergency brake function can be switched off temporarily:

Confirm the message on the Control Display.

During continued driving in this surrounding situation, no further emergency braking will occur.

Settings

It is possible to set which areas on the vehicle will be protected by the system.

1. "CAR"
2. "Settings"
3. "Driver Assistance"
4. "Parking and Maneuvering"
5. "Active PDC with braking interv."
6. Select the desired setting.

System limits

The limits of the systems of the Park Distance Control PDC and the Parking Assistant apply.

If required, deactivate the system via iDrive where applicable.

With Parking Assistant: side parking aid

Principle

The side protection warns of obstacles on the side of the vehicle.

General information

The system uses the ultrasonic sensors of the Park Distance Control PDC and the Parking Assistant.

Safety information

Warning

The system cannot serve as a substitute for the driver's personal judgment in assessing the traffic situation. Based on the limits of the system, it cannot independently react to all traffic situations. There is a risk of accident. Adjust driving style to traffic conditions. Watch traffic and vehicle surroundings closely and actively intervene where appropriate.

Additionally, the safety information for the PDC Park Distance Control and the Automatic Parking Assistant apply.

Additional information:

- ▶ PDC Park Distance Control, refer to page 240.
- ▶ Automatic Parking Assistant, refer to page 247.

Display

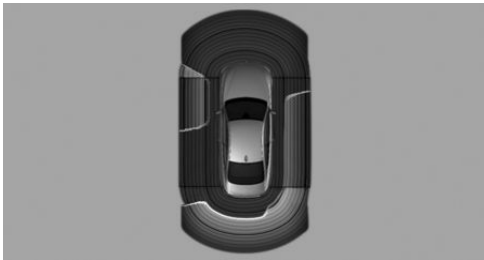

To protect the sides of the vehicle, obstacle markings are displayed on the sides of the vehicle.

- ▶ Color markings: warning against detected obstacles.
- ▶ Gray markings, hatched area: no obstacles were detected.
- ▶ No markings, black area: the area next to the vehicle was not yet captured.

Limits of the side parking aid

The system only displays stationary obstacles that were previously detected by sensors while passing them.

The system does not detect whether an obstacle moves later on. If the vehicle is stationary, the markings are shown in black after a certain time. The area next to the vehicle must be newly captured.

Additionally, the limits of the systems of the Park Distance Control PDC and the Parking Assistant apply.

Without Surround View: rearview camera

Principle

The rearview camera provides assistance in parking and maneuvering backwards. The area behind the vehicle is shown on the Control Display.

Additionally, assistance functions can be shown in the display, e.g., help lines.

Safety information

Warning

The system cannot serve as a substitute for the driver's personal judgment in assessing the traffic situation. Based on the limits of the system, it cannot independently react to all traffic situations. There is a risk of accident. Adjust driving style to traffic conditions. Watch traffic

and vehicle surroundings closely and actively intervene where appropriate.

Overview

Depending on the vehicle equipment: button in the vehicle



Park assistance button

Sensors

The system is controlled by the following sensors:

- ▷ Rearview camera.

Additional information:

Sensors of the vehicle, refer to page 37.

Turning on/off

Turning on automatically

The system is switched on automatically if selector lever position R is engaged when the engine is running.

Automatic deactivation during forward travel

The system switches off when a certain driving distance or speed is exceeded.

Switch the system back on, if needed.

Depending on the vehicle equipment: switching on/off manually



Press the park assistance button.

- ▷ On: the LED lights up.
- ▷ Off: the LED goes out.

The parking assistance functions are shown on the Control Display.

Switching the view via iDrive

If the rearview camera view is not displayed, change the view via iDrive:

1. If necessary, tilt the Controller to the side.
2.  "Rear view camera"

The rearview camera image is displayed.



Functional requirements

- ▷ The trunk lid is fully closed.
- ▷ Keep the recording range of the camera open. Protruding cargo, roof rack systems or trailers can limit the detection range of the camera.

Display on the Control Display

Toolbars

The assistance functions can be activated manually via the toolbars on the sides of the Control Display.

1. Move the Controller to the right, if needed.
2. With corresponding equipment:  "Camera image"
3. ▷  "Parking aid lines".
Pathway lines and turning circle lines are displayed.
- ▷  "Obstacle mark".
Depending on the vehicle equipment, the obstacles detected by PDC Park Distance Control are displayed by markings.

More than one assistance function can be active at the same time.

Parking aid lines

Lanes

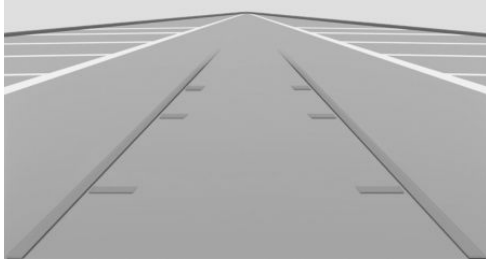

Lanes help you to estimate the space required when parking and maneuvering on level roads.

Lanes depend on the steering angle and are continuously adjusted to the steering wheel movements.

Turning circle lines

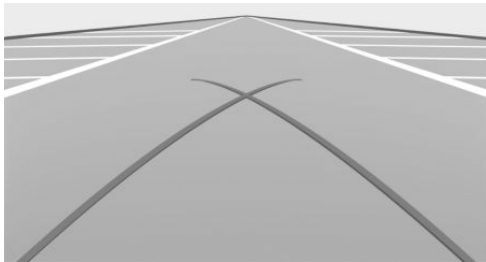

Turning circle lines can only be superimposed on the camera image together with lanes.

Turning circle lines show the course of the smallest possible turning radius on a level road.

Only one turning circle line is displayed after the steering wheel is turned past a certain angle.

Parking using lanes and turning circle lines

1. Position the vehicle so that the red turning circle line leads to within the limits of the parking space.
2. Turn the steering wheel to the point where the green lane covers the corresponding turning circle line.

Obstacle marking

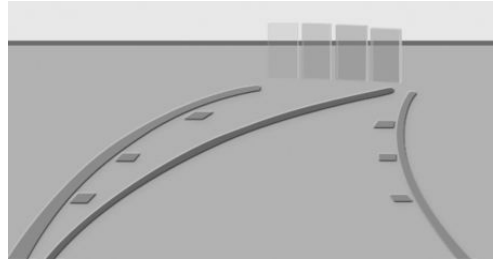

Depending on the vehicle equipment, obstacles behind the vehicle are detected by the PDC Park Distance Control sensors.

Obstacle markings can be faded into the image of the rearview camera.

The colored thresholds of the obstacle markings match the markings of the PDC Park Distance Control.

Setting brightness and contrast

With the rearview camera switched on:

1. Move the Controller to the right, if needed.
2.  "Camera image"
3. Select the desired setting.

System limits

System limits of the sensors

Additional information:

- ▶ Cameras, refer to page 37.

Deactivated camera

When the camera is deactivated, for instance when the trunk lid is open, the camera image is displayed hatched in gray.

Detection of objects

Very low obstacles as well as high, protruding objects such as ledges may not be detected by the system.

Depending on the vehicle equipment, some assistance functions also consider data from the PDC Park Distance Control.

Follow the notes in the PDC Park Distance Control chapter.

The objects displayed on the Control Display may be closer than they appear. Do not estimate the distance from the objects on the display.

With Parking Assistant: Parking Assistant

Principle

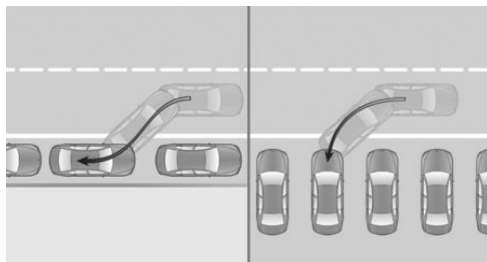

The Automatic Parking Assistant supports the driver in the following situations:

- ▶ When parking parallel to the road, parallel parking.
- ▶ When parking in reverse perpendicular to the road, perpendicular parking. The system orients itself with the middle of the parking space.
- ▶ Depending on the equipment version: when driving out of parallel parking spaces.

General information

Handling

Automatic Parking Assistant handling is divided into three steps:

- ▶ Switching on and activating.
- ▶ Parking space search.
- ▶ Parking.

System status and instructions on required actions are displayed on the Control Display.

Ultrasound sensors measure parking spaces on both sides of the vehicle.

Steptronic transmission

The Automatic Parking Assistant calculates the best possible parking line and takes control of the following functions during the parking operation:

- ▶ Steering.
- ▶ Accelerating and braking.
- ▶ Changing gears.

The parking operation is automatic.

Safety information

Warning

The system cannot serve as a substitute for the driver's personal judgment in assessing the traffic situation. Based on the limits of the system, it cannot independently react to all traffic situations. There is a risk of accident. Adjust driving style to traffic conditions. Watch traffic

closely and actively intervene where appropriate.

NOTICE

The system can steer the vehicle over or onto curbs. There is a risk of damage to property, among other potential damage. Watch traffic closely and actively intervene where appropriate.

The safety information of the PDC Park Distance Control apply in addition.

Additional information:

PDC Park Distance Control, refer to page [240](#).

Overview

Button in the vehicle



Park assistance button

Sensors

The system is controlled by the following sensors:

- ▷ Ultrasound sensors in the front/rear bumpers.
- ▷ Ultrasonic sensors, side.

Additional information:

Sensors of the vehicle, refer to page [37](#).

Functional requirements

For the measurement of parking spaces

- ▷ Maximum speed while driving forward approx. 22 mph/35 km/h.
- ▷ Maximum distance to row of parked vehicles: 5 ft/1.5 m.

Suitable parking space

General information:

- ▷ Gap behind an object that has a min. length of 1.7 ft/0.5 m.
- ▷ Gap between two objects with a minimum length of approx. 1.7 ft/0.5 m.

Parallel parking to the road:

- ▷ Min. length of gap between two objects: own vehicle length plus approx. 2.6 ft/0.8 m.
- ▷ Minimum depth: approx. 5 ft/1.5 m.

Perpendicular parking:

- ▷ Minimum width of the gap: own vehicle width plus approx. 2.3 ft/0.7 m.
- ▷ Minimum depth: own vehicle length.

The depth of diagonal parking spaces must be estimated by the driver. Due to technical limitations, the system is only able to approximate the depth of diagonal parking spaces.

For the parking operation

- ▷ Doors and trunk lid are closed.
- Steptronic transmission:
- ▷ Driver's safety belt is fastened.

Switching on with the button



Press the park assistance button.

The LED lights up.

The current status of the parking space search is indicated on the Control Display.

 Automatic Parking Assistant is activated automatically.

Switching on with reverse gear

1. Shift into reverse.
The current status of the parking space search is indicated on the Control Display.
2. If necessary, activate:  "Autom. Parking"





Switching on via iDrive

Display of the rearview camera or PDC view must be active.

1. Move the Controller to the right.
2. Activate the parking assistant on the Control Display:  "Autom. Parking"



Display on the Control Display

System activated/deactivated

| Icon | Meaning |
|--|---|
|  | Gray: the system is not available. White: the system is available but not activated. |
|  | System is activated. |
|  | Parking space search is active. |
|  | The parking operation is active. The system takes over the steering. |

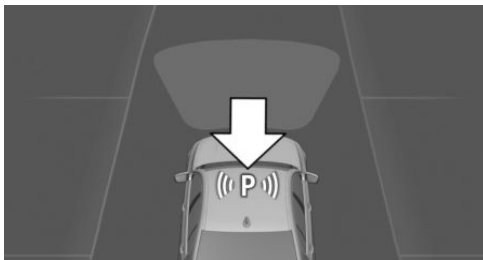
Parking space search and system status



- ▷  Parking assistant is activated and parking space search is active.
- ▷ Control Display shows suitable parking spaces at the edge of the road next to the vehicle symbol. When Park Assistant is active, suitable parking spaces are highlighted and an acoustic signal sounds.
- ▷ If a diagonal or parallel parking space is clearly detected, the system automatically adjusts the suitable parking method. In the case of parking spaces suitable for parallel and diagonal parking, a selection menu is displayed. In this case, the desired parking method must be selected manually.
- ▷  The parking operation is active. The system takes over the steering.
- ▷ Parking space search is always active whenever the vehicle is moving forward slow and straight, even if the system is deactivated. When the system is deactivated, the displays on the Control Display are shown in gray.

Switching signal tone for suitable parking spaces on/off

1. "CAR"
2. "Settings"
3. "Driver Assistance"
4. "Parking and Maneuvering"
5. "Automatic Parking"
6. "Alert if parking space detected"

Signal tones of the PDC Park Distance Control

During an automatic parking operation, no intermittent tone will sound from the PDC Park Distance Control.

A continuous tone sounds when the distance to a detected object is less than approx. 8 inches/20 cm.

Parking using the Automatic Parking Assistant

Parking

1. Switching on and activating the parking assistant.

For this, engage the reverse gear or press the parking assist button and activate the system on the Control Display, if needed.

 Automatic Parking Assistant is activated.

2. Pass the row of parked vehicles forward at a speed of up to approx. 22 mph/35 km/h and at a distance of maximum 5 ft/1.5 m.

The status of the parking space search and possible parking spaces are displayed on the Control Display.

3. Confirm the suggested parking space for the parking operation: select the parking space on the Control Display.

The system takes over the steering.

4. Follow the instructions on the Control Display.

Steptronic transmission:



At the end of the parking operation, the P selector lever position is set.

The end of the parking operation is indicated on the Control Display.

5. Adjust the parking position yourself, if needed.

Interrupting manually

The Automatic Parking Assistant can be interrupted at any time:

- ▷  Press the park assistance button.
- ▷  "Autom. Parking": select the icon on the Control Display.

Interrupting automatically

The system is interrupted automatically in the following situations:

- ▷ When the driver grasps the steering wheel or takes over steering.
- ▷ Possibly on snow-covered or slippery road.
- ▷ When there are obstacles that are hard to overcome, such as curbs.
- ▷ When there are obstacles that suddenly appear.
- ▷ If the PDC Park Distance Control displays clearances that are too small.
- ▷ When a maximum number of parking attempts or the time taken for parking is exceeded.
- ▷ When changing over to another function on the Control Display.

Steptronic transmission:

- ▷ If the trunk lid is open.
- ▷ If doors are open.
- ▷ When setting the parking brake.
- ▷ During acceleration.
- ▷ When the brake pedal remains pressed for an extended period while the vehicle is stationary.
- ▷ When unfastening the driver's safety belt.

A Check Control message is displayed.

Resuming

An interrupted parking operation can be continued, if needed.

Reactivate the parking assistant and follow the instructions on the Control Display.

Turning off

The system can be switched off manually:

-  Press the park assistance button.

System limits

Safety information

Warning

The system is designed to operate in certain conditions and circumstances. Due to conditions or other factors, the system may not respond. There may be a risk of accident or risk of damage to property. Actively intervene as warranted. Refer to the information in this Owner's Manual regarding the scope of the system's operation and limitations.

No parking assistance

The Automatic Parking Assistant does not offer assistance in the following situations:

- ▷ In tight curves.
- ▷ For diagonal parking spaces.

System limits of the sensors

Additional information:

- ▷ Ultrasonic sensors, refer to page 39.

Functional limitations

The system may be limited in the following situations:

- ▷ On bumpy road surfaces such as gravel roads.
- ▷ On slippery ground.
- ▷ On steep uphill or downhill grades.
- ▷ With accumulations of leaves/snow in the parking space.
- ▷ With a mounted emergency wheel.
- ▷ In case of changes to an already-measured parking space.

- ▷ With ditches or edges, for instance an edge of a port.
- ▷ Parking spaces that are not suitable may be detected or suitable parking spaces may not be detected at all.

Malfunction

A Check Control message is displayed.

The Automatic Parking Assistant has malfunctioned. Have the system checked by a dealer's service center or another qualified service center or repair shop.

Depending on the equipment version: driving out of a parking space using the parking assistant

Principle

The system makes driving out of parallel parking spaces easier.

General information

Steptronic transmission

The parking assistant calculates an optimal line for pulling out of a parking space and takes control of the following functions during the maneuver:

- ▷ Steering.
- ▷ Accelerating and braking.
- ▷ Changing gears.

The vehicle maneuvers automatically until the vehicle reaches a position in which the driver can drive out of the parking space without further steering movements.

Safety information

Warning

The system cannot serve as a substitute for the driver's personal judgment in assessing the traffic situation. Based on the limits of the system, it cannot independently react to all traffic situations. There is a risk of accident. Adjust driving style to traffic conditions. Watch traffic closely and actively intervene where appropriate.

Additionally, the safety information for the PDC Park Distance Control and the Automatic Parking Assistant apply.

Additional information:

- ▷ PDC Park Distance Control, refer to page 240.
- ▷ Automatic Parking Assistant, refer to page 247.

Functional requirements

- ▷ The vehicle was parked manually and objects in front of and behind the car are detected. The distance to a detected curb is at least 6 inches/15 cm.
- ▷ The vehicle was parked using the parking assistant and an object is detected in front of the vehicle.
- ▷ The parking space is at least 2.6 ft/0.8 m longer than your vehicle.
- ▷ The vehicle has been parked in reverse.

Driving out of parking spaces

1. Turn on drive readiness.
2. Steptronic transmission:

Press the park assistance button or shift into reverse gear when the vehicle is stationary to switch on the Automatic Parking Assistant.
3. Tilt the Controller to the right and activate the Automatic Parking Assistant on the Control Display:  "Autom. Parking"

4. On the Control Display, confirm the required direction for driving out of the parking space if necessary.
5. Follow the instructions on the Control Display.

Steptronic transmission:

The system takes control of the maneuver. A message will be displayed at the end of the maneuver.
6. Make sure that the traffic situation permits driving out of the parking space and drive off as usual.

The Automatic Parking Assistant is switched off automatically.

System limits

The limits of the systems of the Park Distance Control PDC and the Parking Assistant apply.

With Parking Assistant: Reversing Assistant

Principle

The Back-up Assistant supports the driver when driving in reverse, for instance when driving out of tight or confusing parking or street situations. The vehicle stores the driving movements of the last route. This stored route can be driven back with automated steering.

General information

The system takes control of the steering when driving in reverse along the stored route.

The driver controls driving the vehicle via accelerator pedal and brake.

The Reversing Assistant uses the control elements and sensors of the PDC Park Distance Control and the Automatic Parking Assistant.

Additional information:

- ▶ PDC Park Distance Control, refer to page 240.
- ▶ Parking assistant, refer to page 247.

Safety information

Warning

The system cannot serve as a substitute for the driver's personal judgment in assessing the traffic situation. Based on the limits of the system, it cannot independently react to all traffic situations. There is a risk of accident. Adjust driving style to traffic conditions. Watch traffic closely and actively intervene where appropriate.

Additionally, the safety information for the PDC Park Distance Control and the Automatic Parking Assistant apply.

Additional information:

- ▶ PDC Park Distance Control, refer to page 240.
- ▶ Automatic Parking Assistant, refer to page 247.

Functional requirements

- ▶ Drive forward without interruption to store the route.
- ▶ A maximum of 165 ft/50 m will be stored.
- ▶ To store the route, do not exceed a driving speed of 22 mph/36 km/h.
- ▶ DSC Dynamic Stability Control is activated.

Driving back with automated steering

1. Press the park assistance button or shift into reverse gear when the vehicle is stationary and the drive-ready state is switched on.
2. Move the Controller to the right.
3. "Back-up Assistant"
The system takes over the steering.

4. Follow the instructions on the Control Display where required.
5. Take your hands off the steering wheel and carefully drive off with the accelerator pedal and the brake.

When driving in reverse, pay attention to the vehicle's surroundings, and if you encounter an obstacle, stop immediately and take over control of the vehicle. Follow the instructions on the PDC Park Distance Control.

6. Stop no later than when normal traffic is reached and take control of the vehicle, such as by shifting to a forward gear.

At the end of the stored route, a signal will sound and a request will be displayed, also with the instruction to take control of the vehicle.

Terminating the system

The system automatically cancels in situations such as the following:

- ▶ When the driver grasps the steering wheel or takes over steering.
- ▶ When engaging a forward gear.
- ▶ During activation or intervention by driving control systems or assist systems.
- ▶ After a few minutes when the vehicle is stationary.
- ▶ If the vehicle leaves the stored lane during reversing; for example, at the maximum steering angle.
- ▶ When the display on the Control Display is cross-faded with messages, e.g., due to incoming calls.

System limits

- ▶ When you reach normal road traffic or if you encounter an obstacle, stop immediately and take over control of the vehicle.
- ▶ The maximum speed for driving in reverse is limited to approximately 6 mph/9 km/h.

If the maximum speed is exceeded, a warning is issued and the function may be canceled.

- ▷ After driving a stored distance with major steering-wheel angles, the function of the system will be limited for the return trip.
- ▷ Additionally, the limits of the systems of the Park Distance Control PDC and the Parking Assistant apply.

Different influences can lead to side deviations when driving back on the stored route. For example, this includes the following factors:

- ▷ Steering movements when the vehicle is stationary while storing the distance covered.
- ▷ The speed is not adapted to the distance traveled.
- ▷ Road characteristics, such as gradients or inclines.

With Parking Assistant Plus: Surround View

Principle

Surround View supports the driver in parking and maneuvering. The area around the vehicle is shown on the Control Display.

General information

Several cameras capture the area from different selectable perspectives.

The following camera perspectives can be displayed:

- ▷ Automatic camera perspective: the system shows the camera perspective suitable for the respective driving situation.
- ▷ Rearview camera: for representing the areas behind the vehicle.
- ▷ Right-hand and left-hand side view: for representing the areas on the sides of the vehicle.

- ▷ Unobstructed camera perspective, movable via iDrive.
- ▷ Panorama View: to present cross traffic, for instance at junctions and driveways, depending on the currently engaged gear.

Depending on the view, the vehicle's surroundings or a part of it is depicted.

Additionally, assistance functions are shown in the display, e.g., help lines.

More than one assistance function can be active at the same time.

Some assistance functions can be manually activated.

The following assistance functions are automatically displayed:

- ▷ Side parking aid.
- ▷ Door opening angle.

Safety information

Warning

The system cannot serve as a substitute for the driver's personal judgment in assessing the traffic situation. Based on the limits of the system, it cannot independently react to all traffic situations. There is a risk of accident. Adjust driving style to traffic conditions. Watch traffic and vehicle surroundings closely and actively intervene where appropriate.

Overview

Buttons in the vehicle



 Park assistance button

 Panorama View

Sensors

The system is controlled by the following sensors:

- ▶ Front camera.
- ▶ Top view cameras.
- ▶ Rearview camera.

Additional information:

Sensors of the vehicle, refer to page 37.

Turning on/off

Turning on automatically

The system is switched on automatically if selector lever position R is engaged when the engine is running.

The camera perspective suitable for the respective driving situation is displayed.

Additional information:

Park Distance Control, turn on/off, refer to page 240.

Switching on/off manually

 Press the park assistance button.

- ▶ On: the LED lights up.
- ▶ Off: the LED goes out.

Depending on the equipment version, the rearview camera cannot be switched off when the reverse gear is engaged.

Automatic deactivation during forward travel

The system switches off when a certain driving distance or speed is exceeded.

Switch the system back on, if needed.

Display on the Control Display

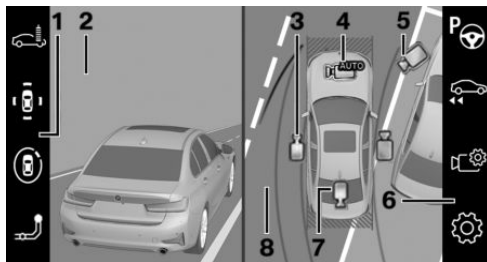

Overview



- 1 Toolbar, left
- 2 Camera image
- 3 Side view
- 4 Automatic camera perspective
- 5 Movable unobstructed camera perspective
- 6 Toolbar, right
- 7 Rearview camera
- 8 Selection window

Toolbar on the left

The left toolbar can be used for the direct selection of various views via iDrive. Move the Controller to the left, if needed.

- ▶  "Parking": around the vehicle.
- ▶  "3D view": available camera.
- ▶  "Car wash".

Side view

The side view can be selected for the right or left vehicle side.

This view helps when positioning the vehicle at the curb or with other obstacles on the side by displaying the side surroundings.

The side view looks from rear to front and in case of danger, focuses automatically on possible obstacles.

Automatic camera perspective

The automatic camera perspective shows a steering-dependent view in the respective driving direction.

This perspective adapts to the respective driving situation.

As soon as obstacles are detected, the view changes to a fixed display of the area in front or at the rear behind the bumper or, if necessary, changes to a side view.

When reverse gear is engaged, the automatic camera perspective is, if necessary, exited and the system uses a fixed perspective of the rearview camera. If necessary, manually select the automatic camera perspective when reverse gear is engaged. The automatic camera perspective will be retained for the current parking operation.

Movable unobstructed camera perspective

With selection of the movable camera perspective, a circle appears on the Control Display.





By turning the Controller or via touch function, specified perspectives on the circle can be selected.



The current perspective is marked with a camera symbol.

To leave the function, move the Controller sideways and select another camera function.

Toolbar on the right

Assistance functions can be activated and settings can be entered via the right toolbar via iDrive. Move the Controller to the right, if needed.

- ▷  "Autom. Parking".
- ▷  "Back-up Assistant".
- ▷  "Camera image":
 - ▷  "Brightness".
 - ▷  "Contrast".

- ▷  "Parking aid lines".
- ▷  "Obstacle mark".
- ▷  "Settings": apply settings, for instance to use the activation points for Panorama View.

Rearview camera

This view shows the picture of the rearview camera.

Selection window

The individual camera perspectives can be selected in the selection window via iDrive.

Parking aid lines

Lanes

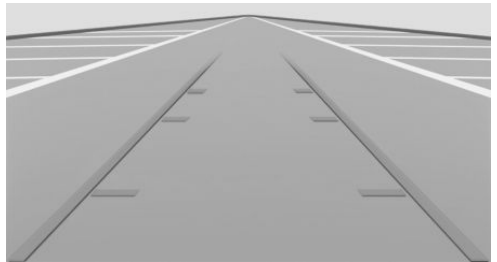

Lanes help you to estimate the space required when parking and maneuvering on level roads.

Lanes depend on the steering angle and are continuously adjusted to the steering wheel movements.

Turning circle lines

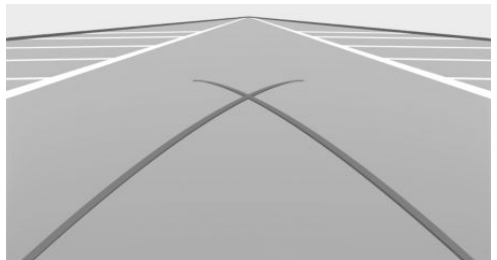

Turning circle lines can only be superimposed on the camera image together with lanes.

Turning circle lines show the course of the smallest possible turning radius on a level road.

Only one turning circle line is displayed after the steering wheel is turned past a certain angle.

Parking using lanes and turning circle lines

1. Position the vehicle so that the red turning circle line leads to within the limits of the parking space.
2. Turn the steering wheel to the point where the green lane covers the corresponding turning circle line.

Obstacle marking

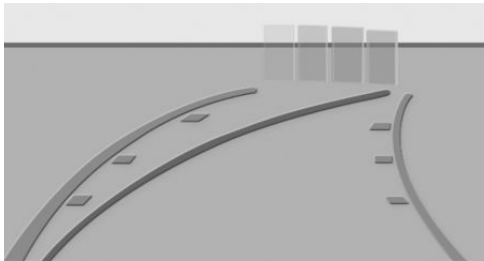

Obstacles behind the vehicle are detected by the PDC Park Distance Control sensors.

Obstacle markings can be shown in the camera image.

The colored thresholds of the obstacle markings match the markings of the PDC Park Distance Control.

Car wash view

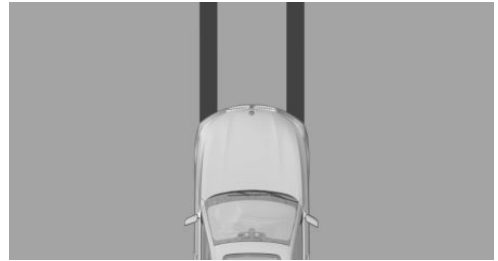

The car wash view assists when entering a car wash by displaying the floor and the vehicle's own track.

Side parking aid

Principle

The system warns of obstacles on the side of the vehicle.

Display



To protect the sides of the vehicle, obstacle markings are displayed on the sides of the vehicle.

- ▷ No markings: no obstacles were detected.
- ▷ Color markings: warning against detected obstacles.

Limits of the side parking aid

The system only displays stationary obstacles that were previously detected by sensors while passing them.

The system does not detect whether an obstacle moves later on. For this reason, at standstill, the markings are not shown anymore in the display after a certain time. The area next to the vehicle must be newly captured.

Door opening angle

Principle

If obstacle marking is activated, the Surround View indicates fixed obstacles that obstruct the opening angles of the doors.

The system does not provide a warning of approaching road users.

Display

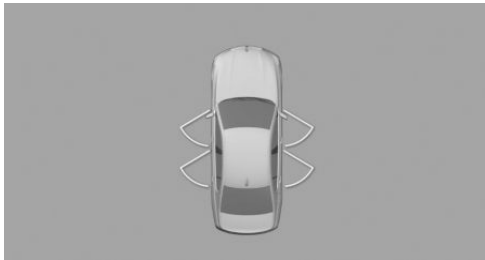

Steptronic transmission: the maximum opening angles of the doors are displayed in selector lever position P. As soon as the vehicle begins moving, the opening angles are replaced by parking aid lines.

Limits of the display

The vehicle's surroundings are displayed with distorted image for technical reasons.

Even if the symbols for the door opening angles do not cross other objects on the Control Display, the following needs to be noted when parking next to other objects:

Because of the perspective, higher, protruding objects may be closer than they appear on the Control Display.

Setting brightness and contrast

Brightness and contrast can be adjusted with Surround View or Panorama View switched on.

1. Move the Controller to the right, if needed.
2.  "Camera image"
3. Select the desired setting.

Functional limitations

The system can be used only to a limited extent in the following situations:

- ▷ In poor light.
- ▷ In case of soiled cameras.
- ▷ With a door open.
- ▷ With the trunk lid open.
- ▷ With exterior mirrors folded in.

Gray hatched areas with icon, for instance open door, in the camera image mark areas that are currently not displayed.

System limits

System limits of the sensors

Additional information:

- ▷ Cameras, refer to page 37.

Non-visible areas

Because of the camera angle, the areas under the vehicle cannot be viewed by the cameras.

Detection of objects

Very low obstacles as well as high, protruding objects such as ledges may not be detected by the system.

Some assistance functions also consider data from the PDC Park Distance Control.

Follow the notes in the PDC Park Distance Control chapter.

The objects displayed on the Control Display may be closer than they appear. Do not estimate the distance from the objects on the display.

Additional information:

PDC Park Distance Control, refer to page 240.

Malfuction

A camera malfunction is displayed on the Control Display.



A yellow icon is displayed and the recording range of the malfunctioning camera is displayed in black on the Control

Display.

With Parking Assistant Plus: Panorama View

Principle

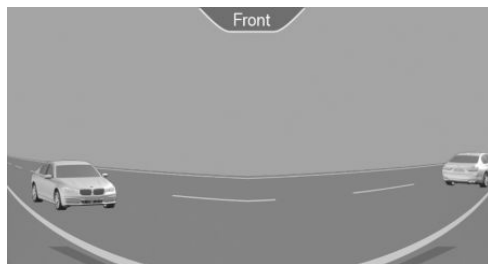

Panorama View gives you an earlier view of crossing traffic at blind driveway exits and intersections.

General information

Road users concealed by obstacles to the left and right of the vehicle can only be detected relatively late from the driver's seat. The cameras in the front and rear capture the sideways traffic area to improve the view.

Yellow lines in the screen display mark the front and rear end of the vehicle.

The camera image shows different levels of distortion in some areas and is thus not suitable for distance estimations.

Depending on the equipment version, the function can only be used when driving forward.

Additional information:

Surround View, refer to page 254.

Safety information

Warning

The system cannot serve as a substitute for the driver's personal judgment in assessing the traffic situation. Based on the limits of the system, it cannot independently react to all traffic situations. There is a risk of accident. Adjust driving style to traffic conditions. Watch traffic and vehicle surroundings closely and actively intervene where appropriate.

Overview

Button in the vehicle



 Panorama View

Sensors

The system is controlled by the following sensors:

- ▷ Front camera.
- ▷ Depending on the equipment: rearview camera.

Additional information:

Sensors of the vehicle, refer to page 37.

Display on the Control Display



Press the button when the engine is running.

Depending on the driving direction, the image of the respective camera is displayed:

- ▷ "Front": front camera image.
- ▷ "Rear": rear camera image.

Depending on the vehicle equipment, cross traffic warning can additionally warn of approaching vehicles using radar sensors.

Additional information:

Cross traffic warning, refer to page [262](#).

With navigation system: activation points

Principle

Positions where Panorama View should switch on automatically can be stored as activation points provided that a Global Positioning System signal is received.

General information

Up to ten activation points can be stored.

Activation points can be used when driving forward for the front camera.



Storing activation points

1. Drive to the position at which the system is to be switched on, and stop.
2.  Press the button.
3. Tilt the Controller to the right.
4. "Activation point"
The current position is displayed.
5. "Save activation point"



Activation points are, if possible, stored with town/city and street address, or else with the Global Positioning System coordinates.

Using activation points



The use of activation points can be switched on and off.

1.  Press the button.
2. Tilt the Controller to the right.
3.  "Settings"
4. "Panorama View, GPS-based"
5. "Panorama View is displayed automatically when set activation points are reached."

Displaying activation points

1.  Press the button.
2. Tilt the Controller to the right.
3.  "Manage points"
A list of all activation points is displayed.

Renaming or deleting activation points

1.  Press the button.
2. Tilt the Controller to the right.
3.  "Manage points"
A list of all activation points is displayed.
4. Select an activation point as needed.
5. Select the desired setting.

Functional limitations

The Surround View functional limitations apply.

Additional information:

Surround View, refer to page [254](#).

System limits

The limits of the Surround View system apply.

Additional information:

Surround View, refer to page [254](#).

With Parking Assistant Plus: Remote 3D View

Principle

The BMW app and the pictures of the Surround View cameras in combination with the corresponding equipment enable the display of the vehicle's surroundings on a mobile device.

The function displays a momentary view of the situation.

Sensors

The system is controlled by the following sensors:

- ▶ Front camera.
- ▶ Top view cameras.
- ▶ Rearview camera.

Additional information:

Sensors of the vehicle, refer to page 37.

Functional requirements

- ▶ Data transmission must be activated.
Data protection, refer to page 68.
- ▶ BMW app must be installed on the mobile device.
- ▶ ConnectedDrive countries: a driver profile with an existing ConnectedDrive account must be activated.
Driver profiles, refer to page 69.

Switching the function on/off

Switching on/off with other functions

1. "CAR"
2. "Settings"
3. "General settings"
4. "Data privacy"
5. Select the desired setting.

Switching on/off individually

Pre-adjustment

1. "CAR"
2. "Settings"
3. "General settings"
4. "Data privacy"
5. "Select services individually"
6. "My BMW app & customer portal"
7. "Remote 3D View"

Turning on/off

1. "CAR"
2. "Settings"
3. "General settings"
4. "Data privacy"
5. "Individual selection"

System limits of the sensors

Additional information:

- ▶ Cameras, refer to page 37.

Functional limitations

The system may not be fully functional or may not be available in the following situations:

- ▶ With a door or the trunk lid open. Dark fields in the display indicate areas that are not recorded by the system.
- ▶ With manually folded in exterior mirrors.
- ▶ When other camera functions are being performed in the vehicle.
- ▶ When the vehicle moves faster than walking speed.
- ▶ It may not be possible to use the function in every country.
- ▶ For reasons of data protection, the function can only be used three times within two hours.

Cross traffic warning

Principle

At blind driveway exits or when driving out of perpendicular parking spaces, road users approaching from the side are detected sooner by the cross traffic warning than is possible from the driver's seat.

General information

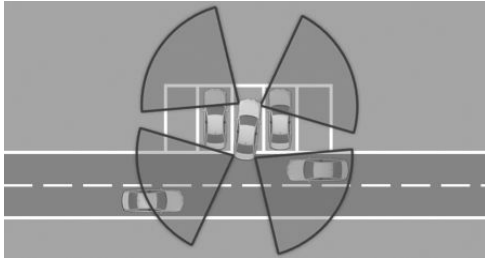

Two radar sensors in the rear bumper monitor the area behind the vehicle.

The system indicates approaching road users.

Depending on the vehicle equipment, the traffic area in front of the vehicle is monitored as well. Two additional radar sensors are located in the front bumpers.

Safety information

Warning

The system cannot serve as a substitute for the driver's personal judgment in assessing visibility and traffic situation. There is a risk of accident. Adjust driving style to traffic conditions. Watch traffic closely and actively intervene where appropriate.

Overview

Button in the vehicle



 Park assistance button

Sensors

The system is controlled by the following sensors:

- ▷ Radar sensors, side, rear.
- ▷ Depending on the equipment: radar sensors, side, front.



Additional information:

Sensors of the vehicle, refer to page [37](#).

Switching on/off

Activating/deactivating the system

With the button

1.  Press the park assistance button.
2. Tilt the Controller to the right.
3.  "Settings"
4. "Cross Traffic Warning"
5. "Cross traffic warning"

Via iDrive

1. "CAR"
2. "Settings"
3. "Driver Assistance"
4. "Parking and Maneuvering"

5. "Cross Traffic Warning"
6. "Cross traffic warning"

Turning on automatically

If the system was activated on the Control Display, it is automatically switched on as soon as PDC Park Distance Control or Panorama View is active and a gear is engaged.

If reverse gear is engaged, the rear system is switched on.

Depending on the vehicle equipment, the front system is switched on when a forward gear is engaged.

Switching off automatically

The system is automatically switched off in the following situations:

- ▶ When the speed exceeds walking speed.
- ▶ When a certain driving distance is exceeded.
- ▶ With an active parking operation of the Automatic Parking Assistant.

Warning

General information

The respective display is called up on the Control Display. A signal tone may sound and the light in the exterior mirror may flash.

Light in the exterior mirror



The light in the exterior mirror flashes if vehicles are detected by the rear sensors and your own vehicle is moving in reverse.

Display in the PDC Park Distance Control view

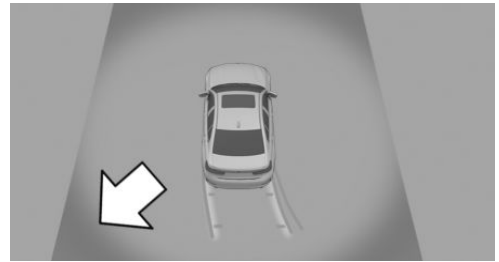

In the PDC Park Distance Control view, the respective boundary area flashes red, if vehicles are detected by the sensors.

Display in the camera view

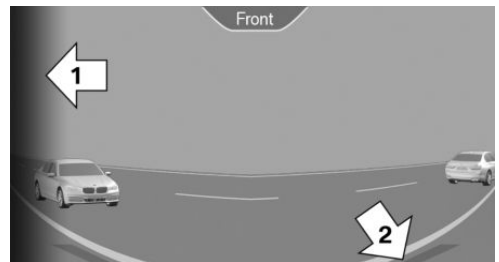

The respective boundary area, arrow 1, in the camera view flashes red, if vehicles are detected by the sensors.

Yellow lines, arrow 2, mark the bumper of your own vehicle.

Acoustic warning

In addition to the optical indicator, a warning signal sounds if your own vehicle moves into the respective direction.

System limits

System limits of the sensors

Additional information:

- ▷ Radar sensors, refer to page 38.

Functional limitations

The system may be limited in the following situations:

- ▷ In tight curves.
- ▷ When crossing objects move at a very slow or a very fast speed.
- ▷ If other objects are in the capture range of the sensors, that hide cross traffic.

Driving comfort

Vehicle features and options

This chapter describes all standard, country-specific and optional features offered with the series. It also describes features and functions that are not necessarily available in your vehicle, e.g., due to the selected options or country versions. This also applies to safety-related functions and systems. When using these functions and systems, the applicable laws and regulations must be observed.

Chassis components

The chassis components are optimized for the vehicle and its application range and thereby ensure the best possible Driving Dynamics.

Adaptive M chassis

Principle

The Adaptive M chassis is an intelligent, controllable sport chassis.

The chassis reduces body movements with a sporty driving style or on an uneven road.

General information

The intelligent control of the chassis increases the driving dynamics and driving comfort depending on the road condition and driving style.

Tuning

The system offers different shock absorber settings ranging from comfortable travel to sporty driving.

The shock absorbers are adjusted depending on the selected driving mode as well as the road condition and driving style.

Additional information:

Driving Dynamics Control, refer to page [133](#).

Performance Control

Performance Control enhances the agility of the vehicle.

To increase maneuverability, wheels are braked individually when a sporty driving style is used.

Engine sound

Depending on the equipment and national-market version, you may be able to configure the sound of the engine.

1. "CAR"
2. "Settings"
3. "General settings"
4. "Engine sound"
5. Select the desired setting.

Climate control

Vehicle features and options

This chapter describes all standard, country-specific and optional features offered with the series. It also describes features and functions that are not necessarily available in your vehicle, e.g., due to the selected options or country versions. This also applies to safety-related functions and systems. When using these functions and systems, the applicable laws and regulations must be observed.

Air quality

General information

The air quality in the interior is improved by the following components:

- ▷ Emission tested passenger compartment.
- ▷ Interior filter.
- ▷ Air conditioning system to control the temperature, air flow and recirculated-air mode.
- ▷ Pre-ventilation.
- ▷ Depending on the equipment:
Automatic recirculated-air control.

Interior filter

Depending on the equipment, the interior filter cleans the inflowing outside air and improves the air quality:

- ▷ Dust and pollen is filtered out from the inflowing air.
- ▷ Nano-particle emissions are reduced.
- ▷ Gaseous pollutants are filtered.
- ▷ Microbial particles and allergens are filtered.







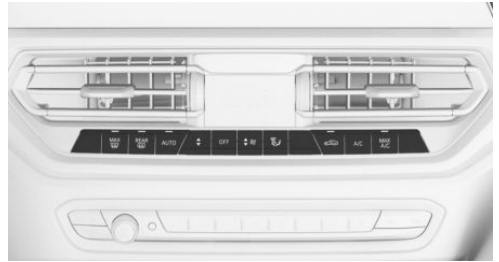

Automatic climate control



Overview

Buttons in the vehicle



Climate control functions

| Button | Function |
|---|---------------------------|
|  | Defrost function. |
|  | Rear window defroster. |
|  | AUTO program. |
|  | Temperature. |
|  | Switching off. |
|  | Air flow, manual. |
|  | Air distribution, manual. |
|  | Air recirculation mode. |
|  | Air conditioning. |

| Button | Function |
|--|---|
|  | Maximum cooling. |
|  | Seat heating, refer to page 122 . |

Some of the functions can also be used via voice, e.g., temperature.

Switching climate control functions on/off

Turning on

Press one of the following buttons:

- ▷ Temperature.
- ▷ Air conditioning.
- ▷ Maximum cooling.
- ▷ AUTO program.
- ▷ Air recirculation mode.
- ▷ Air flow, manual.
- ▷ Air distribution, manual.
- ▷ Defrosting the windshield

Turning off

Complete system:

 Press the button until the automatic climate control switches off.

Temperature

Principle

The automatic climate control cools or heats to the configured temperature and then keeps the temperature constant.

Setting the temperature

Using the button:

 Press the upper or lower button side to set the desired temperature.

Via iDrive:

1. "CAR"
2. "Settings"
3. "Climate control"
4. "Heating/ventilation"
5. "Driver"
6. "Temperature:"
7. Set the desired temperature.

Do not rapidly switch between different temperature settings. Otherwise, the automatic climate control will not have sufficient time to adjust the set temperature.

Air conditioning

Principle

The air in the car's interior will be cooled and dehumidified and, depending on the temperature setting, warmed again.

Functional requirement

The car's interior can only be cooled with the drive-ready state switched on.

Switch climate control function on/off

 Press the button.
The LED is illuminated when the climate control function is switched on.

Depending on the weather, the windshield and the side windows may fog up briefly when drive-ready state is switched on.

Air conditioning is switched on automatically with the AUTO program.

When using the cooling mode, condensation that will exit below the vehicle.

Maximum cooling

Principle

The system is set to the lowest temperature, optimum air flow and recirculated-air mode with the drive-ready state switched on.

Functional requirement

The system is available at outside temperatures above approx. 32 °F/0 °C and with the drive-ready state switched on.

Switching maximum cooling on/off

 Press the button. The LED is illuminated when maximum cooling is switched on.

Air flows out of the air vents to the upper body region. The air vents need to be open for this.

The air flow can be adjusted with the program active.

AUTO program

Principle

The AUTO program cools, ventilates or heats the car's interior automatically.

The air flow, air distribution and the temperature will be controlled automatically depending on the interior temperature and the setting for the desired temperature.

Switching the AUTO program on/off

Using the button:

 Press the button. The LED of the button is illuminated with the AUTO program switched on.

Via iDrive:

1. "CAR"
2. "Settings"
3. "Climate control"

4. "Heating/ventilation"

5. "Automatic"

Depending on the selected temperature and outside influences, the air is directed to the windshield, side windows, upper body, and into the floor area.

Point the side air vents toward the side windows.

The cooling function is switched on with the AUTO program.

The AUTO program is switched off automatically, when manual air distribution is set.

Air recirculation mode

Principle

You may react to unpleasant odors or pollutants in the immediate environment by temporarily suspending the supply of outside air. The system then recirculates the interior air.

When recirculated-air mode is switched off, fresh air is directed into the vehicle's interior.

Switch air recirculation on/off

Using the button:

 Press the button. The LED of the button is illuminated when the air-recirculation mode is switched on.

Via iDrive:

1. "CAR"
2. "Settings"
3. "Climate control"
4. "Air quality"
5. Select the desired setting:
 - ▶ "Air recirculation"
 - ▶ "Fresh air"

To prevent window fogging, recirculated-air mode switches off automatically after a certain amount of time, depending on the environmental conditions.

With constant air recirculation mode, the air quality in the car's interior deteriorates and window fogging increases.

If there is window condensation, switch off recirculated-air mode or defog the windows.

Air flow, manual

Principle

The air flow for climate control can be adjusted manually.

Adjusting the air flow manually



Press the lower or upper side of the button: decrease or increase air flow.

The selected air flow is shown on the climate control display.

The air flow may be reduced automatically to save battery power.

Manual air distribution

Principle

The air distribution for climate control can be adjusted manually.

Adjusting the air distribution manually



Press the button repeatedly. Select the desired setting:

- ▶ Windows, upper body region, and floor area.
- ▶ Upper body region and floor area.
- ▶ Floor area.
- ▶ Windows and floor area.
- ▶ Windows.
- ▶ Windows and upper body.
- ▶ Upper body region.

The selected air distribution is shown on the climate control display.

Defrost function

Principle

Ice and condensation are quickly removed from the windshield and the front side windows.

Switching the Defrost function on/off



Press the button.

The LED of the button is illuminated when the system is switched on.

The air flow can be adjusted manually with the system switched on.

If there is any window condensation, switch on the air conditioning. Make sure that air can flow to the windshield.

Rear window defroster

Principle

Ice and condensation are removed from the rear window quickly.

Functional requirement

The function is operational when the drive-ready state is switched on.

Switching rear window defroster on/off



Press the button. The LED is illuminated with rear window defroster switched on.

The rear window defroster switches off automatically after a certain period of time.

Microfilter

The microfilter removes dust and pollen from the incoming air.

Have this filter changed during vehicle maintenance.

Automatic climate control with enhanced features

Overview

Buttons in the vehicle

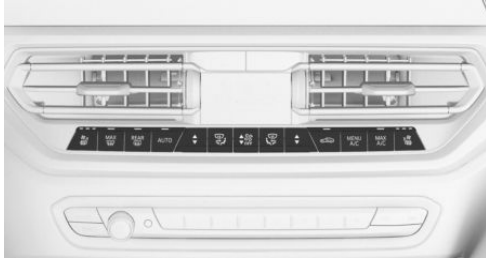

Climate control functions

| Button | Function |
|--------|--|
| | Temperature. |
| | Air recirculation mode. |
| | Maximum cooling. |
| | AUTO program. |
| | Air flow, manual. Switching off. Intensity AUTO program. |
| | Air distribution, manual. |
| | Defrost function. |
| | Rear window defroster. |

| Button | Function |
|--------|---|
| | Seat heating, refer to page 122. |
| | Air conditioning. Open Climate menu, such as for the following settings: upper body temperature adjustment, pre-ventilation, air conditioning. |

Some of the functions can also be used via voice, e.g., temperature.

Opening the Climate menu

Press the button.

The Climate menu is displayed.

For example, the following climate control functions can be accessed via the Climate menu:

- ▷ Air quality.
- ▷ Heating/ventilation.
- ▷ Pre-ventilation/heating
- ▷ Air conditioning.

Individual settings can be entered for some of the climate functions, e.g., switching on/off, intensity.

Switching climate control functions on/off

Turning on

Press one of the following buttons:

- ▷ Temperature.
- ▷ Air conditioning.
- ▷ Maximum cooling.
- ▷ AUTO program.
- ▷ Air recirculation mode.
- ▷ Upper side of the air flow, manual button.
- ▷ Air distribution, manual.
- ▷ Defrosting the windshield

Turning off

Complete system:



Press and hold the button until the integrated automatic climate control switches off.

Temperature

Principle

The automatic climate control cools or heats to the configured temperature and then keeps the temperature constant.

Setting the temperature

Using the button:



Press the upper or lower button side to set the desired temperature.

Via iDrive:

1. "CAR"
2. "Settings"
3. "Climate control"
4. "Heating/ventilation"
5. "Driver" or "Front passenger"
6. "Temperature:"
7. Set the desired temperature.
8. "OK"

Do not rapidly switch between different temperature settings. Otherwise, the automatic climate control will not have sufficient time to adjust the set temperature.

Temperature of the ventilation

General information

The temperature of the ventilation in the upper body region can be adjusted.

The air flow of the ventilation in the upper body region heats or cools noticeably, depending on the adjusted temperature.

This does not change the set interior temperature for the driver and front passenger.

Adjust temperature of the ventilation

1. "CAR"
2. "Settings"
3. "Climate control"
4. "Heating/ventilation"
5. "Temperature adjustment"
6. Set the desired temperature.

The temperature is individually adjusted, e.g. colder toward blue, warmer toward red.

Air conditioning

Principle

The air in the car's interior will be cooled and dehumidified and, depending on the temperature setting, warmed again.

Functional requirement

The car's interior can only be cooled with the drive-ready state switched on.

Switch climate control function on/off

Using the button:



Press the button.

Via iDrive:

1. "CAR"
2. "Settings"
3. "Climate control"
4. "Heating/ventilation"
5. "A/C"

Depending on the weather, the windshield and the side windows may fog up briefly when drive-ready state is switched on.

Air conditioning is switched on automatically with the AUTO program.

When using the cooling mode, condensation that will exit below the vehicle.

Maximum cooling

Principle

The system is set to the lowest temperature, optimum air flow and recirculated-air mode with the drive-ready state switched on.

Functional requirement

The function is available at an outside temperature above approx. 32 °F/0 °C and with the drive-ready state switched on.

Switching maximum cooling on/off



Press the button.

The LED is illuminated when maximum cooling is switched on.

Air flows out of the air vents to the upper body region. The air vents need to be open for this.

The air flow can be adjusted with the program active.

AUTO program

Principle

The AUTO program cools, ventilates or heats the car's interior automatically.

The air distribution and the temperature are controlled automatically depending on the interior temperature and the desired temperature setting including the selected intensity of the air flow.

Switching the AUTO program on/off

Using the button:



Press the button.

The LED of the button is illuminated with the AUTO program switched on.

Via iDrive:

1. "CAR"
2. "Settings"
3. "Climate control"
4. "Heating/ventilation"
5. "Driver"
6. "Automatic"

Depending on the selected settings and outside influences, the air is directed to the windshield, side windows, upper body, and into the floor area.

Point the side air vents toward the side windows.

The cooling function is switched on with the AUTO program.

At the same time, a condensation sensor controls the program so as to prevent window condensation as much as possible.

The AUTO program is switched off automatically, when manual air distribution is set.

Controlling the intensity of the air flow

With the AUTO program switched on, the intensity can be adjusted. This changes the automatic control for the air mass.

Using the button:



Press the lower or upper side of the button: decrease or increase intensity.

Via iDrive:

1. "CAR"
2. "Settings"
3. "Climate control"
4. "Heating/ventilation"
5. "Driver"
6. "Level"
7. Set the desired intensity.

The selected intensity is shown on the climate control display.

Automatic recirculated-air control

Principle

The automatic recirculated-air control recognizes pollutants in the outside air. The outside air supply is shut off and the interior air is recirculated.

General information

If the system is activated, a sensor detects pollutants in the outside air and controls the shut-off automatically.

If the system is deactivated, outside air continuously flows into the car's interior.

With constant air recirculation mode, the air quality in the car's interior deteriorates and window fogging increases.

If there is window condensation, switch off recirculated-air mode or defog the windows.

Switching automatic recirculated-air control on/off

1. "CAR"
2. "Settings"
3. "Climate control"
4. "Air quality"
5. "Automatic"

Air recirculation mode

Principle

You may react to unpleasant odors or pollutants in the immediate environment by temporarily suspending the supply of outside air. The system then recirculates the interior air.

When recirculated-air mode is switched off, fresh air is directed into the vehicle's interior.

Switch air recirculation on/off

Using the button:



Press the button.

The LED of the button is illuminated when the air-recirculation mode is switched on.

Via iDrive:

1. "CAR"
2. "Settings"
3. "Climate control"
4. "Air quality"
5. Select the desired setting:
 - ▷ "Air recirculation"
 - ▷ "Fresh air"

To prevent window fogging, recirculated-air mode switches off automatically after a certain amount of time, depending on the environmental conditions.

With constant air recirculation mode, the air quality in the car's interior deteriorates and window fogging increases.

If there is window condensation, switch off recirculated-air mode or defog the windows.

Air flow, manual

Principle

The air flow for climate control can be adjusted manually.

General information

To adjust the air flow manually switch off AUTO program first.

Adjusting the air flow manually



Press the lower or upper side of the button: decrease or increase air flow.

The selected air flow is shown on the climate control display.

The air flow may be reduced automatically to save battery power.

Manual air distribution

Principle

The air distribution for climate control can be adjusted manually.

Adjusting the air distribution manually



Press the button repeatedly. Select the desired setting:

- ▷ Windows, upper body region, and floor area.
- ▷ Upper body region and floor area.
- ▷ Floor area.
- ▷ Windows and floor area.
- ▷ Windows.
- ▷ Windows and upper body region.
- ▷ Upper body region.

The selected air distribution is shown on the climate control display.

SYNC program

Principle

The Sync program can be used to apply the settings on the driver's side to the passenger's side.

Switching the SYNC program on/off

1. "CAR"
2. "Settings"
3. "Climate control"
4. "Synchronize"

The following settings of the driver's side can be transferred to the front-passenger side:

- ▷ Temperature.
- ▷ Air flow.
- ▷ Air distribution.
- ▷ AUTO program.

The program is switched off automatically if the settings on the front passenger side are changed.

Defrost function

Principle

Ice and condensation are quickly removed from the windshield and the front side windows.

Switching the Defrost function on/off



Press the button.

The LED of the button is illuminated when the system is switched on.

The air flow can be adjusted manually with the system switched on.

If there is window condensation, switch on the AUTO program or the air conditioning to utilize the condensation sensor. Make sure that air can flow to the windshield.

Rear window defroster

Principle

Ice and condensation are removed from the rear window quickly.

Functional requirement

The function is operational when the drive-ready state is switched on.

Switching rear window defroster on/off



Press the button. The LED is illuminated with rear window defroster switched on.

The rear window defroster switches off automatically after a certain period of time.

Microfilter/activated-charcoal filter

The microfilter removes dust and pollen from the incoming air.

The activated-charcoal filter also removes gaseous pollutants from the outside air that enters the vehicle.

Have this combined filter changed during vehicle maintenance.

Ventilation

Principle

The air flow directions can be adjusted individually for direct or indirect ventilation.

Setting the ventilation

General information

Open the air vents and position them to ensure effective climate control.

Direct ventilation

The air flow is directed towards the passengers. The air flow heats or cools noticeably, depending on the adjusted temperature.

Indirect ventilation

The air flow is not directed towards the passengers. The vehicle interior is warmed or cooled indirectly, depending on the set temperature.

Front ventilation

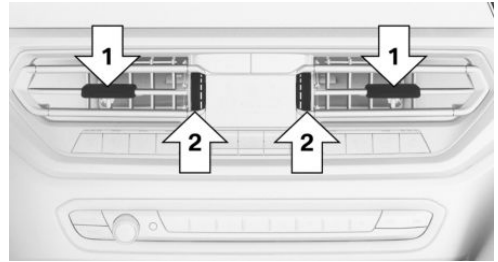

- ▶ Lever for changing the air flow direction, arrow 1.
- ▶ Thumbwheel for variable opening and closing of the air vents, arrow 2.

Ventilation in rear, center

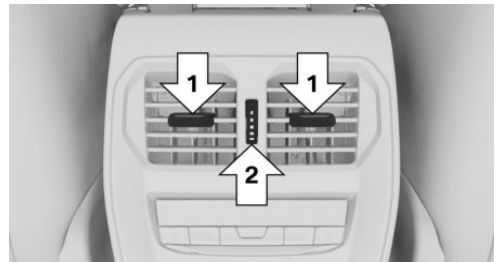

- ▶ Lever for changing the air flow direction, arrow 1.
- ▶ Thumbwheel for variable opening and closing of the air vents, arrow 2.





Rear automatic climate control

Overview

Buttons in the vehicle



Climate control functions

| Button | Function |
|--|---|
|  | Temperature. |
|  | AUTO program. |
|  | Air distribution, manual. |
|  | Seat heating, refer to page 122 . |
|  | Switching off. |

Switching climate control functions on/off

Functional requirement

The rear automatic climate control is not ready for operation if the automatic climate control is switched off or if the function for defrosting the windows and removing condensation is active.

Switching on/off using iDrive

1. "CAR"
2. "Settings"
3. "Climate control"
4. "Heating/ventilation"
5. "Second row of seats"
6. "Activate heating/cooling"

Switching on using the button

Press one of the following buttons:

- ▷ Temperature.
- ▷ AUTO program.
- ▷ Air distribution, manual.

Switching off using the button

 Press the button.

Temperature

Principle

The automatic climate control cools or heats to the configured temperature and then keeps the temperature constant.

Setting the temperature

Using the button:

 Press the left or right button side to set the desired temperature.

Via iDrive:

1. "CAR"
2. "Settings"
3. "Climate control"
4. "Heating/ventilation"
5. "Second row of seats"
6. "Temperature:"
7. Set the desired temperature.

The selected temperature is shown on the climate control display.

Do not rapidly switch between different temperature settings. Otherwise, the automatic climate control will not have sufficient time to adjust the set temperature.

AUTO program

Principle

The air flow, air distribution and the temperature are controlled automatically.

Switching the AUTO program on/off

Using the button:

 Press the button. The LED of the button is illuminated with the AUTO program switched on.

Via iDrive:

1. "CAR"
2. "Settings"
3. "Climate control"
4. "Heating/ventilation"
5. "Second row of seats"
6. "Automatic"

Depending on the selected settings and outside influences, the air is directed to the upper body and into the floor area.

Manual air distribution

Principle

The air distribution for climate control can be adjusted manually.

Adjusting the air distribution manually

 Press the button repeatedly. Select the desired setting:

- ▷ Upper body region.
- ▷ Upper body region and floor area.
- ▷ Floor area.

Locking the control elements

Principle

The control elements of the rear automatic climate control can be disabled.

Activate/deactivate

1. "CAR"
2. "Settings"
3. "Climate control"
4. "Heating/ventilation"
5. "Second row of seats"
6. "Disable controller"

Pre-ventilation

Principle

The car's interior can be cooled or heated before driving off with the pre-ventilation. Depending on set temperature and ambient temperature, the car's interior is ventilated or possibly heated using the residual engine heat.

General information

The system can be switched on and off directly or via a preset departure time.

The activation time is determined based on the outside temperature. The system promptly switches on before the selected departure time.

Functional requirements

- ▷ The vehicle is in idle state or standby state and not in drive-ready state.
 - ▷ The battery is sufficiently charged.
- If pre-ventilation is switched on, the vehicle battery will be discharged. Thus, limit the

maximum activation time to save the vehicle battery. The system will be available again after the engine is started or after a short trip.

- ▷ Make sure that the vehicle's date and time are set correctly.
- ▷ Open the air vents to allow air to flow out.

Switching on/off directly

General information

There are different ways to switch the system on or off.

The system switches off automatically after a certain period of time. The system continues to run for some time after being switched off.

Using the button

Functional requirement

When the vehicle is in standby state, the pre-ventilation can be switched on or off with the automatic climate control buttons.

Turning on

Press one of the following buttons:

- ▷ Temperature.
- ▷ Air conditioning.
- ▷ Maximum cooling.
- ▷ AUTO program.
- ▷ Air recirculation mode.
- ▷ Upper side of the air flow, manual button.
- ▷ Air distribution, manual.
- ▷ Defrosting the windshield

Turning off



Press and hold the bottom button.

The system switches off after leaving and locking the vehicle.

Via iDrive

Turning on

1. "CAR"
2. "Settings"
3. "Climate control"
4. "Pre-ventilation"
5. "Start now"

Display

| Icon | Description |
|------|---|
| | Symbol on the climate control display. Flashing: the pre-ventilation is switched on. |

Departure time

Principle

Different departure times can be set to ensure a comfortable interior temperature in the vehicle at the time of departure.

- ▷ One-time departure time: the time can be set.
The system is switched on once.
- ▷ Departure time with weekday: time and day of the week can be set.
On the desired weekdays, the system will be switched on before the set departure time.

The departure time is preselected in two steps:

- ▷ Set departure times.
- ▷ Activate departure times.

A minimum of 10 minutes should pass between setting/activating the departure time and the planned departure time to allow a sufficient period of time for the climate control.

Setting the departure time

Via iDrive

1. "CAR"
2. "Settings"
3. "Climate control"
4. "Pre-ventilation"
5. "Departure plan"
6. Select the desired departure time.
7. Set the departure time.
8. Select day of the week, if needed.
9. "OK"

Activating the departure time



Functional requirement

To switch on the parked-car ventilation automatically at the departure time, the departure time must be activated first.

Via iDrive

1. "CAR"
2. "Settings"
3. "Climate control"
4. "Pre-ventilation"
5. "Departure plan"
6. Activate the desired departure time.

Display

 ,  Symbol on the climate control display signals an activated departure time.

Pre-conditioning through Remote Engine Start

Principle

Pre-conditioning cools or heats the car's interior prior to departure to a comfortable temperature. The system automatically cools, vents, and heats

depending on the interior, external, and set temperature. Snow and ice may be removed more easily.

The system starts the engine automatically and allows it to run for a limited period of time.

Safety information

DANGER

If the exhaust pipe is blocked or ventilation is insufficient, harmful exhaust gases can pollute the area in and around the vehicle or enter into the vehicle. The exhaust gases contain pollutants which are colorless and odorless. In enclosed areas or areas with insufficient ventilation, exhaust gases can also accumulate outside of the vehicle. There is danger to life. Keep the exhaust pipe free and ensure sufficient ventilation. Do not switch on stationary climate control in enclosed areas or areas with insufficient ventilation, e.g. in enclosed garages.

Warning

When stationary climate control is in operation, high temperatures can occur underneath the body, for instance caused by the exhaust gas system. If combustible materials, such as leaves or grass, come in contact with hot parts of the exhaust gas system, these materials can ignite. There is a risk of fire. Make sure that no combustible materials can come in contact with hot vehicle parts during stationary climate control operation, e.g. leaves, grass, gas, gasoline, oil or other combustible objects.

Functional requirements

- ▷ The vehicle is in idle state or standby state and not in drive-ready state.
- ▷ Battery is sufficiently charged.
- ▷ For reasons of safety, the system can only be switched on twice consecutively. The system will be available again as soon as the drive-

ready state is activated and deactivated again.

- ▷ The fuel tank capacity is sufficient.
- ▷ Hood is closed.
- ▷ Make sure that the vehicle's date and time are set correctly.
- ▷ Air vents are opened.

Enabling the automatic engine start function

The automatic engine start must be enabled before using the system. Otherwise, the engine cannot switch on automatically to climatize the car's interior.

Via iDrive:

1. "CAR"
2. "Settings"
3. "Climate control"
4. "Preconditioning/ventilation"
5. "Remote Engine Start"
6. "Starting engine for clim. control"
7. Confirm the disclaimer.

Switching on/off directly

General information

The system switches off automatically after approx. 15 minutes.

For reasons of safety, the system can only be switched on twice consecutively. The system will be available again as soon as the drive-ready state is activated and deactivated again.

Switching on via iDrive

1. "CAR"
2. "Settings"
3. "Climate control"
4. "Preconditioning/ventilation"
5. "Start now"

Switching on/off via vehicle key

The system can be switched on and off using the vehicle key.



Press the button on the vehicle key three times within 1 second.

After operating the vehicle key, it will take approximately 3 seconds until the engine is switched on.

To switch off the system, press the button again three times.

Switching off with the Start/Stop button

The system can be switched off directly as follows: pressing the Start/Stop button, without operating the brake pedal.

Switching on via departure time

General information

Scheduled departure times can be set up in the system to ensure a comfortable interior temperature in the vehicle at the time of departure.

- ▷ One-time departure time: the time of the scheduled departure can be set.
The system is switched on once.
- ▷ Departure time with weekday: time and day of the week of the scheduled departure can be set.

The departure time is preselected in two steps:

- ▷ Set departure times.
- ▷ Activate departure times.

The climate control function will start approximately 10 minutes before the set departure time and continue for approximately 5 more minutes after the departure time.

A minimum of 10 minutes should pass between setting/activating the departure time and the planned departure time to allow a sufficient period of time for the climate control.

For reasons of safety, the system can only be switched on once. The system will be available again as soon as the drive-ready state is activated and deactivated again.

Observe the information about the intended use of the vehicle.

Additional information:

For Your Own Safety, refer to page 8.

Adjusting the departure time via iDrive

1. "CAR"
2. "Settings"
3. "Climate control"
4. "Preconditioning/ventilation"
5. "Departure plan"
6. Select the desired departure time.
7. Set the departure time.
8. Select day of the week, if needed.

Activating the departure time via iDrive

1. "CAR"
2. "Settings"
3. "Climate control"
4. "Preconditioning/ventilation"
5. "Departure plan"
6. Activate the desired departure time.

Display

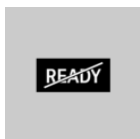

In the instrument cluster:

The engine runs for the purpose of operating the pre-conditioning. The vehicle is not ready to drive.

 The icon on the automatic climate control signals an activated departure time.

 The icon flashes while Remote Engine Start is running.

Confirmation signals from the vehicle

The activation of the system is confirmed by flashing twice.

The parking lights are switched on as long as the system is switched on.

Interior equipment

Vehicle features and options

This chapter describes all standard, country-specific and optional features offered with the series. It also describes features and functions that are not necessarily available in your vehicle, e.g., due to the selected options or country versions. This also applies to safety-related functions and systems. When using these functions and systems, the applicable laws and regulations must be observed.

Integrated Universal Remote Control

Principle

The integrated Universal Remote Control in the interior mirror can operate up to 3 functions of remote-controlled systems such as garage door drives, barriers, or lighting systems.

General information

The Integrated Universal Remote Control replaces up to 3 different hand-held transmitters. To operate the remote control, the buttons on the interior mirror must be programmed with the desired functions. The hand-held transmitter for the particular system is required in order to program the remote control.

Before selling the vehicle, delete the stored functions for the sake of security.

If possible, do not install the antenna of the remote-controlled system, e.g. the garage door drive, near metal objects to ensure the best possible operation.

Safety information

Warning

The operation of remote-controlled systems with the integrated universal remote control, such as the garage door, may result in injury, for example, body parts becoming jammed in a garage door. There is a risk of injury or risk of damage to property. Make sure that the area of movement of the respective system is clear during programming and operation. Also follow the safety information for the hand-held transmitter.

Compatibility



If this symbol is printed on the packaging or in the operating instructions of the system to be controlled, the system is generally compatible with the integrated Universal Remote Control.

Additional questions are answered by:

- ▶ A dealer's service center or another qualified service center or repair shop.
- ▶ www.homelink.com on the Internet.

HomeLink is a registered trademark of Gentex Corporation.

Control elements on the interior mirror

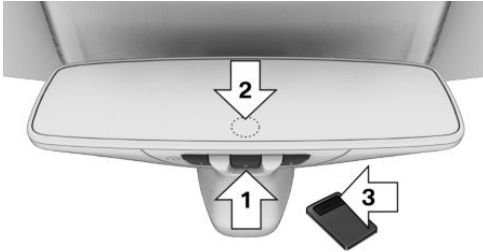

- ▶ Buttons, arrow 1.
- ▶ LED, arrow 2.
- ▶ The hand-held transmitter, arrow 3, is required for programming.

Programming

General information

The battery of the hand-held transmitter must be fully charged at the time of programming to ensure an optimal range of the integrated universal remote control.

1. Turn on standby state.
2. Initial commissioning:
Press and hold the two outer buttons on the interior mirror simultaneously for approximately 10 seconds until the LED flashes green rapidly. This erases all programming of the buttons on the interior mirror.
3. Press the interior mirror button to be programmed. The LED on the interior mirror will slowly begin flashing orange.
4. Hold the hand-held transmitter for the system to be used approx. 1 to 12 in/2.5 to 30 cm away from the buttons on the interior mirror. The required distance depends on the hand-held transmitter.
5. Press and hold the button of the desired function on the hand-held transmitter.

Canada: if programming with the hand-held transmitter was interrupted, hold down the interior mirror button and repeatedly press and release the hand-held transmitter button for 2 seconds.

6. ▶ The LED lights up green: programming completed.
Release the button.
 - ▶ The LED flashes fast: programming is not complete.
Press the button on the interior mirror for 2 seconds and release. Perform this procedure three times to complete the programming procedure.
If the integrated universal remote control remains nonoperational, continue with the special features for change code wireless systems.
 - ▶ LED does not flash green after 60 seconds: programming not completed.
Repeat steps 3 to 6.

To program other functions on other buttons, repeat steps 3 to 5.

Special feature of the rolling code wireless system

If you are unable to operate the remote-controlled system after repeated programming, please check if the system to be controlled features a rolling code radio system.

Refer to the operating instructions for the system.

For systems with a rolling code radio system, the integrated Universal Remote Control and the system also have to be synchronized.

Please read the operating instructions to find out how to synchronize the system.

Synchronizing is easier with the aid of a second person.

Synchronizing the universal remote control with the system:

1. Park the vehicle within range of the remote-controlled system.
2. Program the relevant button on the interior mirror as described.
3. Locate and press the synchronizing button on the system being programmed, e.g. at the garage gate. You have approx. 30 seconds for the next step.
4. Hold down the programmed button on the interior mirror for approximately 3 seconds and then release it. If necessary, repeat this step up to three times in order to end synchronization. Once synchronization is complete, the programmed function will be carried out.

Reprogramming individual buttons

1. Turn on standby state.
2. Press and hold the interior mirror button to be programmed.
3. As soon as the LED on the interior mirror flashes orange after approx. 20 seconds, release the button.
4. Hold the hand-held transmitter for the system to be used approx. 1 to 12 in/2.5 to 30 cm away from the buttons on the interior mirror. The required distance depends on the hand-held transmitter.
5. Press and hold the button of the desired function on the hand-held transmitter.

Canada: if programming with the hand-held transmitter was interrupted, hold down the interior mirror button and repeatedly press and release the hand-held transmitter button for 2 seconds.

6. The LED can light up in different ways.
 - ▶ The LED lights up green: the programming procedure is completed.

Release the button.

- ▶ The LED flashes fast: the hand-held transmitter was detected but programming is not complete.

Press the button on the interior mirror for 2 seconds and release. Perform this procedure three times to complete the programming procedure.

If the integrated universal remote control remains nonoperational, continue with the special features for change code wireless systems.

- ▶ LED does not flash green after 60 seconds: programming not completed.

Repeat steps 3 to 6.

If the programming procedure is not completed, the previous programming will remain unchanged.

Operation

Warning

The operation of remote-controlled systems with the integrated universal remote control, such as the garage door, may result in injury, for example, body parts becoming jammed in a garage door. There is a risk of injury or risk of damage to property. Make sure that the area of movement of the respective system is clear during programming and operation. Also follow the safety information for the hand-held transmitter.

The system, such as the garage door, can be operated using the button on the interior mirror while the drive-ready or standby state is switched on. To do this, hold down the button within receiving range of the system until the function is activated. The interior mirror LED stays lit while the wireless signal is being transmitted.

Deleting stored functions

All stored functions will be deleted. The functions cannot be deleted individually.

Press and hold the two outer buttons on the interior mirror simultaneously for approximately 10 seconds until the LED on the interior mirror flashes green fast.

Sun visor

Glare shield

Fold the sun visor down or up.

Glare shield from the side

Folding out

1. Fold the sun visor down.
2. Unhook it from the holder and swing it to the side.
3. Move it back to the desired position.

Folding in

Proceed in the reverse order to close the sun visor.

Vanity mirror

A vanity mirror is located in the sun visor behind a cover. When the cover is opened, the mirror lighting switches on.

Ashtray

Front center console

Opening

1. Press onto the cover.



2. The ashtray is located in a cup holder. Fold the ashtray cover upward.



Emptying



Pull the ashtray with the closed cover out of the cup holder.

Cigarette lighter

Safety information

Warning

Contact with the hot heating element or the hot socket of the cigarette lighter can cause burns. Flammable materials can ignite if the cigarette lighter falls down or is held against the objects. There is a risk of fire and an injury hazard.

There is a risk of damage to property, among other potential damage. Take hold of the cigarette lighter by its handle. Make sure that children do not use the cigarette lighter.

NOTICE

If metal objects fall into the socket, they can cause a short circuit. There is a risk of damage to property, among other potential damage. Insert the cigarette lighter or socket cover again after using the socket.

Front center console



Press onto the cover.



The cigarette lighter is located between the cup holders.

Operation



Push in the cigarette lighter.

The cigarette lighter can be removed as soon as it pops back out.

Sockets

Principle

The lighter socket can be used as a socket for electrical equipment when standby and drive-ready state are switched on.

General information

The total load of all sockets must not exceed 140 watts at 12 volts.

Do not damage the socket by using non-compatible connectors.

Safety information

Warning

Devices and cables in the unfolding area of the airbags, such as portable navigation devices, can hinder the unfolding of the airbag or be thrown around in the car's interior during unfolding. There is a risk of injury. Make sure that

devices and cables are not in the airbag's area of unfolding.

NOTICE

Battery chargers that charge the vehicle battery via sockets or cigarette lighters in the vehicle may overload or damage the 12 V electrical system. There is a risk of damage to property, among other potential damage. Only connect battery chargers for the vehicle battery to the starting aid terminals in the engine compartment.

NOTICE

If metal objects fall into the socket, they can cause a short circuit. There is a risk of damage to property, among other potential damage. Insert the cigarette lighter or socket cover again after using the socket.

Front center console

1. Press onto the cover.



2. A socket is located between the cup holders. Pull off the cover.

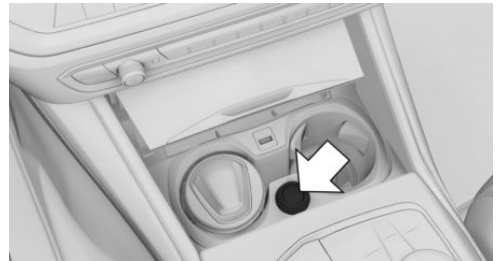

In the cargo area

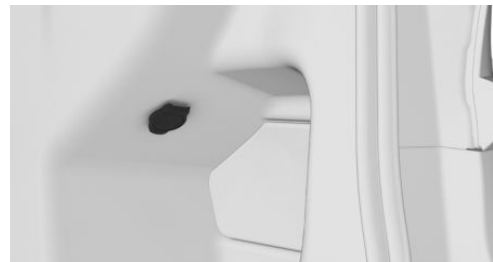

A socket is located on the right side in the cargo area. Unfold the cover.

USB port

General information

Follow the information regarding the connection of mobile devices to the USB port in the section on USB connections.

Additional information:

USB connections, refer to page 80.

In the center armrest



A USB port is located in the center armrest.

Properties:

- ▷ USB port Type C.
- ▷ For charging of mobile devices.
- ▷ Charge current: max. 3 A.
- ▷ With navigation system: for data transfer.

In the front center console

NOTICE

Objects in the storage compartment, e.g., large USB connectors, may block or damage the cover when it is being opened or closed. There is a risk of damage to property, among other potential damage. Make sure that the area of movement of the cover is clear while opening and closing it.



Press onto the cover.

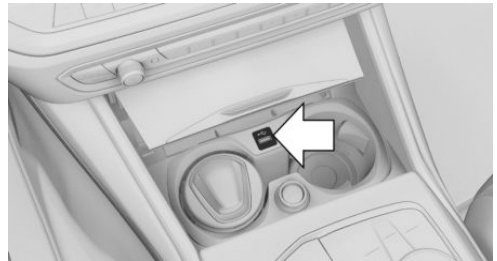

A USB port is located in the center console.

Properties:

- ▷ USB port Type A.
- ▷ For charging mobile devices and for data transmission.
- ▷ Charge current: max. 1.5 A.

In the rear center console



Two USB ports are located in the center console in the rear passenger compartment.

Properties:

- ▷ USB port Type C.
- ▷ For charging of mobile devices.
- ▷ Charge current: maximum 3 A per port.

Wireless charging tray

Principle

The wireless charging tray enables the following wireless functions:

- ▷ Charging the rechargeable battery of a mobile phone with Qi capability and of other mobile devices, which support the Qi standard.

General information

When inserting the mobile phone, make sure there are no objects between it and the wireless charging tray.

During charging, the surface of the tray and the mobile phone may become warm. Higher temperatures may lead to a reduction in the charge current through the mobile phone, and in isolated cases the charging process is paused temporarily. Follow the relevant instructions in the mobile phone owner's manual.

(⚡) The charge indicator shows on the Control Display whether a mobile phone with Qi capability is being charged.

NOTE

This device has been tested for human exposure limits and found compliant at a minimum distance of 2 in/5 cm during operation.

Therefore, a distance of 4 in/10 cm must be maintained in every direction when operating the device.

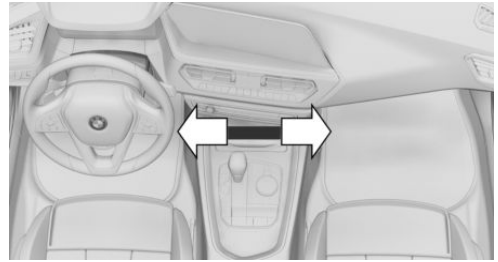

Mounting position of the product.

Safety information

⚠ Warning

When charging a device that meets the Qi standard in the wireless charging tray, any metal objects located between the device and the tray can become very hot. Placing storage devices or electronic cards, such as chip cards, cards with magnetic strips or cards for signal transmission, between the device and the tray may impair the card function. There is a risk of injury and risk of damage to property. When charging mobile devices, make sure there are no objects between the device and the tray.

Overview

Manual transmission: storage in the center armrest

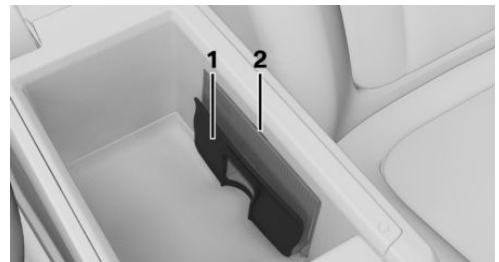

- 1 Car mount
- 2 LED

Steptronic transmission: storage in the center console

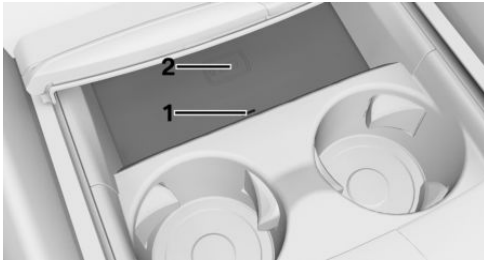

- 1 LED
- 2 Storage area

Functional requirements

- ▷ The mobile phone must compatibly support the required Qi standard.
If the mobile phone does not support the Qi standard, the mobile phone can be charged using a special Qi-compatible charging case.
- ▷ Standby state is switched on.
- ▷ Observe the maximum dimensions of the mobile phone.
- ▷ Use only protective jackets and covers up to a maximum thickness of 0.07 in/2 mm; otherwise, the charging function may be impaired.
- ▷ The mobile phone to be charged is located in the center of the tray.

Steptronic transmission: storage in the center console

Inserting the mobile phone

The mobile phone must not exceed the maximum size of approximately 6.0 x 3.1 x 0.7 in/154.5 x 80 x 18 mm.

1. Open the tray cover.
2. Place the mobile phone centered in the tray with the display facing up.
3. Close the tray cover.

Removing the mobile phone

1. Open the tray cover.
2. Remove the mobile phone.

LED displays

| Color | Meaning |
|--------|---|
| Blue | The mobile phone is charging. The blue LED stays illuminated once the inserted mobile phone with Qi capability is fully charged. |
| Orange | The mobile phone is not charging. Temperature on the mobile phone possibly too high or foreign object in charging tray. |
| Red | The mobile phone is not charging. Contact a dealer's service center or another qualified service center or repair shop. |

Forgotten warning

General information

If the vehicle is equipped with the forgotten warning function, a warning can be output if a mobile phone with Qi capability was forgotten in the wireless charging tray when leaving the vehicle.

The forgotten warning is displayed in the instrument cluster.

Activating

1. "CAR"
2. "Settings"
3. "General settings"
4. "Wireless charging tray"
5. Activate reminder.

System limits

At high temperatures on the mobile phone or in the vehicle, the charging functions of the mobile phone may be limited and some functions may no longer work.

LTE-Compensator - Information and User Manual

Your car is equipped with a wireless charging tray (WCA) to charge your mobile phone and connect it to the mobile network. To ensure the best possible connection a signal booster (LTE-Compensator) is used in conjunction with the WCA. The following paragraphs refer to this booster:

This is a CONSUMER device.

BEFORE USE, you MUST REGISTER THIS DEVICE with your wireless provider and have your provider's consent. Most wireless providers consent to the use of Compensators. Some providers may not consent to the use of this device on their network. If you are unsure, contact your provider. You MUST operate this device with approved antennas and cables as specified by the manufacturer. Antennas MUST be installed at least 20 cm (8 inches) from any person. You MUST cease operating this device immediately if requested by the FCC or a licensed wireless service provider. Warning E911 location information may not be provided or may be inaccurate for calls served by using this device.

Please observe additionally the following information

- ▶ Sprint Nextel will allow consumers to register their signal boosters by calling their toll-free number.
- ▶ T-Mobile online registration link: (www.T-Mobile.com/BoosterRegistration); (<https://saqat.t-mobile.com/sites/SignalBooster#>).
- ▶ Verizon's online registration link: (<http://www.verizonwireless.com/wcms/consumer/register-signal-booster.html>).

- ▶ AT&T online registration link (<https://securec45.securewebsession.com/attsignal-booster.com/>).
- ▶ U.S.Cellular online registration link (<http://www.uscellular.com/uscellular/support/fcc-booster-registration.jsp>).

Before use you must register your booster device with your wireless provider.

If you should be requested by the FCC to cease operating your booster you are not allowed to insert your mobile phone in the charging tray anymore unless the booster is permanently deactivated by your local BMW dealer.

You must not remove the booster from the car nor use it with any other than the preinstalled coupling device or antenna. Any modification of the existing antenna or coupling device as well as the use of other antennas or coupling devices will cause the cease of the booster's operating license.

The booster device fulfills the network protection standards as required by the FCC, such as intermodulation limits, oscillation detection and gain limits.

Booster Manufacturer: Kathrein Automotive

Model Number: LTECOMPB0

Part Number: 6803145-01

FCC-ID: 2ACC7LTECOMPB0

Storage compartments

Vehicle features and options

This chapter describes all standard, country-specific and optional features offered with the series. It also describes features and functions that are not necessarily available in your vehicle, e.g., due to the selected options or country versions. This also applies to safety-related functions and systems. When using these functions and systems, the applicable laws and regulations must be observed.

Storage compartments

General information

The vehicle interior contains multiple storage compartments for stowing objects.

Safety information

Warning

Loose objects or devices with a cable connection to the vehicle, for instance mobile phones, can be thrown about the car's interior while driving, for instance in the event of an accident, braking or evasive maneuver. There is a risk of injury. Secure loose objects or devices with a cable connection to the vehicle in the car's interior.

NOTICE

Anti-slip pads such as anti-slip mats can damage the dashboard. There is a risk of damage to property, among other potential damage. Do not use anti-slip pads.

Front passenger side glove compartment

Safety information

Warning

Folded open, the glove compartment protrudes in the car's interior. Objects in the glove compartment can be thrown into the car's interior while driving, for instance in the event of an accident, braking or evasive maneuvers. There is a risk of injury. Always close the glove compartment immediately after using it.

Opening the glove compartment

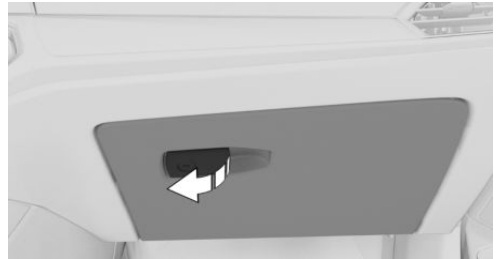

Pull the handle.

The light in the glove compartment switches on.

Closing the glove compartment

Fold cover closed.

Locking the glove compartment

The glove compartment can be locked with an integrated key. This prevents access to the glove compartment.

After the glove compartment is locked, the vehicle key can be handed over without the

integrated key, for instance when the vehicle is parked by valet parking.

Additional information:

Integrated key, refer to page 91.

Driver's side glove compartment

Safety information

Warning

Folded open, the glove compartment protrudes in the car's interior. Objects in the glove compartment can be thrown into the car's interior while driving, for instance in the event of an accident, braking or evasive maneuvers. There is a risk of injury. Always close the glove compartment immediately after using it.

Opening the glove compartment



Pull the handle.

Closing the glove compartment

Fold cover closed.

Compartments in the doors

General information

There are storage compartments in the doors.

Safety information

Warning

Breakable objects, such as glass bottles or glasses, can break in the event of an accident or a braking or evasive maneuver. Broken glass can be scattered in the car's interior. There is a risk of injury or risk of damage to property. Do not use any breakable objects while driving. Only stow breakable objects in closed storage compartments.

Storage compartment in the center console

Opening the storage compartment



Press onto the cover.

Closing the storage compartment

Pull the cover on the handle bar back.

Storage compartment in the rear center console

With the corresponding equipment, the rear of the center console contains a storage compartment.

Center armrest, front

General information

A storage compartment is located in the center armrest between the seats.

Opening the storage compartment



Press the button.

Closing the storage compartment

Press cover down until it engages.

Front cup holder

Safety information

Warning

Unsuitable containers in the cup holders may damage the cup holders or be thrown about the car's interior in the event of an accident, an evasive maneuver, or forceful braking. Spilled liquids can distract from the traffic conditions and lead to an accident. Hot drinks can damage the cup holder or lead to scalding. There is a risk of injury or risk of damage to property. Do not force objects into the cup holder. Use light-weight, shatterproof, and sealable containers. Do not transport hot beverages.

Opening the cup holder



Press onto the cover.



Two cup holders are located in the center console.

Closing the cup holder

Pull the cover on the handle bar back.

Rear cup holder

Safety information

Warning

Unsuitable containers in the cup holders may damage the cup holders or be thrown about the car's interior in the event of an accident, an evasive maneuver, or forceful braking. Spilled liquids can distract from the traffic conditions and lead to an accident. Hot drinks can damage the cup holder or lead to scalding. There is a risk of injury or risk of damage to property. Do not force objects into the cup holder. Use light-weight, shatterproof, and sealable containers. Do not transport hot beverages.

weight, shatterproof, and sealable containers. Do not transport hot beverages.

⚠ NOTICE

With an open cup holder, the center armrest cannot be folded back up. There is a risk of damage to property, among other potential damage. Press back the covers before the center armrest is folded up.

Opening and closing the cup holder

Opening the cup holder

1. Pull the center armrest forward at the loop.
2. Press the button to open the cup holder.

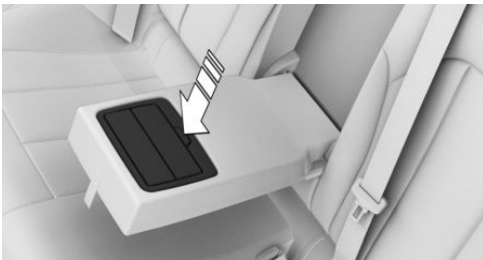

Closing the cup holder

Press both covers back inward in sequence and fold the center armrest back.

Clothes hooks

General information

The clothes hooks are located in the grab handles in the rear.

Safety information

⚠ Warning

Clothing articles on the clothes hooks can obstruct the view while driving. There is a risk of accident. When suspending clothing articles from the clothes hooks, ensure that they will not obstruct the driver's view.

⚠ Warning

Improper use of the clothes hooks can lead to a risk of objects flying about during braking and evasive maneuvers. There is a risk of injury and risk of damage to property. Only hang light-weight objects, for instance clothing articles, from the clothes hooks.

Cargo area

Vehicle features and options

This chapter describes all standard, country-specific and optional features offered with the series. It also describes features and functions that are not necessarily available in your vehicle, e.g., due to the selected options or country versions. This also applies to safety-related functions and systems. When using these functions and systems, the applicable laws and regulations must be observed.

Loading

Safety information

Warning

High gross weight can overheat the tires, damage them internally and cause a sudden tire pressure loss. Driving characteristics may be negatively impacted, reducing lane stability, lengthening the braking distances and changing the steering response. There is a risk of accident. Pay attention to the permitted load capacity of the tires and never exceed the permitted gross weight.

Warning

Loose objects or devices with a cable connection to the vehicle, for instance mobile phones, can be thrown about the car's interior while driving, for instance in the event of an accident, braking or evasive maneuver. There is a risk of injury. Secure loose objects or devices with a cable connection to the vehicle in the car's interior.

Warning

Improperly stowed objects can shift and be thrown into the car's interior, for instance in the event of an accident or during braking and evasive maneuver. Vehicle occupants can be hit and injured. There is a risk of injury. Stow and secure objects and cargo properly.

NOTICE

Fluids in the cargo area can cause damage. There is a risk of damage to property, among other potential damage. Make sure that no fluids leak in the cargo area.

Steps for Determining Correct Load Limit

1. Locate the statement "The combined weight of occupants and cargo should never exceed XXX kg or XXX lbs" on your vehicle's placard.
2. Determine the combined weight of the driver and passengers that will be riding in your vehicle.
3. Subtract the combined weight of the driver and passengers from XXX kg or XXX lbs
4. The resulting figure equals the available amount of cargo and luggage load capacity. For example, if the "XXX" amount equals 1,400 lbs and there will be five 150 lbs passengers in your vehicle, the amount of available cargo and luggage load capacity is 650 lbs (1,400 - 750 (5 x 150) = 650 lbs)
5. Determine the combined weight of luggage and cargo being loaded on the vehicle. That weight may not safely exceed the available

cargo and luggage load capacity calculated in Step 4.

- If your vehicle will be towing a trailer, load from your trailer will be transferred to your vehicle. Consult this manual to determine how this reduces the available cargo and luggage load capacity of your vehicle.

Payload

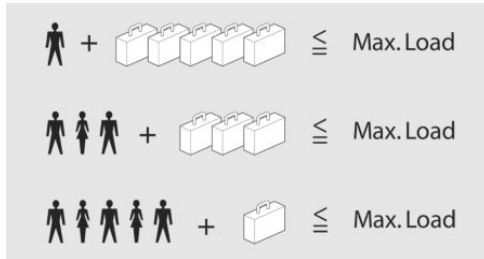

The maximum load is the sum of the weight of the occupants and the cargo.

The greater the weight of the occupants, the less cargo that can be transported.

Stowing and securing cargo

- ▶ Cover sharp edges and corners on the cargo.
- ▶ Heavy cargo: stow as far forward as possible, directly behind and at the bottom of the rear passenger seat backrests.
- ▶ Very heavy cargo: stow as far forward as possible, directly behind and at the bottom of the rear passenger seat backrests. When the rear seat is not occupied, secure each of the outer safety belts in the opposite buckle.
- ▶ Fold down the rear seat backrests completely to stow large cargo.
- ▶ Do not stack cargo above the upper edge of the backrests.
- ▶ Small and light cargo: secure with ratchet straps or, depending on the equipment, with a cargo net or draw straps.
- ▶ Larger and heavy cargo: secure with cargo straps.

Lashing eyes in the cargo area

General information

Attach load securing aids, such as lashing straps, tensioning straps, draw straps or cargo nets, to the lashing eyes in the cargo area.

Lashing eyes

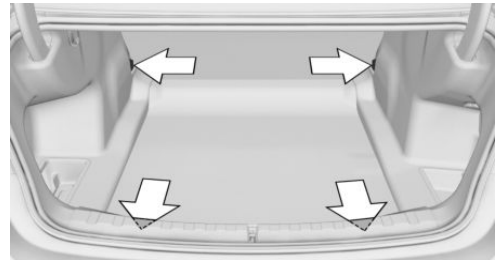

There are four lashing eyes in the cargo area for securing cargo.

Multifunction hook

General information



A multifunction hook is located on the left side in the cargo area.

Safety information

Warning

Improper use of the multifunction hooks can lead to a risk of objects flying about during braking and evasive maneuvers, for example. There is a risk of injury and risk of damage to property. Only hang lightweight objects from the multifunction hooks. Only transport heavy luggage in the cargo area if it has been appropriately secured.

Net

Smaller objects can be stowed in the net on the left or right side.

Storage compartment on the right side

A storage compartment is available on the right side of the cargo area.

Storage compartment on the left side

A storage compartment is located on the left side in the cargo area.

With emergency wheel: storage compartment under the cargo floor panel

General information

There is a storage compartment under the cargo floor panel.

Opening the storage compartment

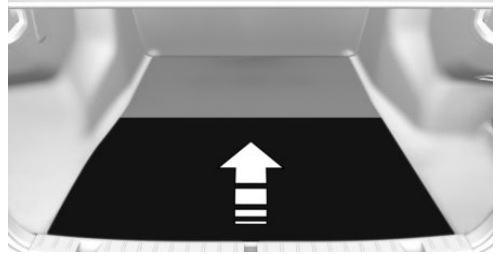

Fold up the cargo floor panel.

Closing the storage compartment

Push the cargo floor panel downward.

Through-loading system

Principle

The cargo area can be enlarged by folding down the rear seat backrests.

General information

The rear seat backrest is divided at a ratio of 40–20–40. The side rear seat backrests and the center section can be folded down separately.

The rear seat backrests can be folded down from the cargo area. The center section can be separately folded down from the rear.

Safety information

Warning

Danger of jamming with folding down the backrests. There is a risk of injury or risk of damage to property. Make sure that the area of movement of the rear backrest and the of the head restraint is clear prior to folding down.

⚠ Warning

If a rear seat backrest is not locked, unsecured cargo can be thrown about the car's interior; for instance, in the event of an accident, braking or an evasive maneuver. There is a risk of injury. Make sure that the rear seat backrest is locked after folding it back.

⚠ Warning

The stability of the child restraint system is limited or compromised with incorrect seat setting or improper installation of the child seat. There is a risk of injury or danger to life. Make sure that the child restraint system fits securely against the backrest. If possible, adjust the backrest tilt for all affected backrests and correctly adjust the seats. Make sure that seats and backrests are securely engaged or locked. If possible, adjust the height of the head restraints or remove them.

⚠ NOTICE

Vehicle parts can be damaged when folding down the rear backrest. There is a risk of damage to property, among other potential damage. Make sure that the area of movement of the rear backrest including head restraint is clear when folding down.

Folding down the rear seat backrest from the cargo area

1. Unlock the belt lock of the center safety belt in the rear using the latch plate of another safety belt.
2. Insert the latch plate at the end of the belt into the specially designated fixture on the rear shelf.

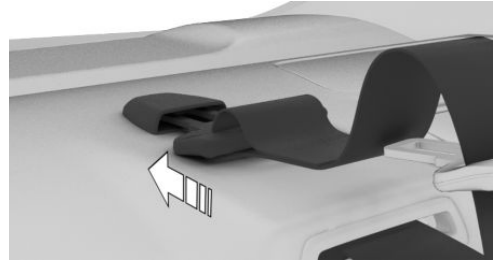

3. Push the corresponding head restraint down as far as it will go.
4. Pull the corresponding lever in the cargo area to release the rear seat backrest. The unlocked rear seat backrest moves forward slightly.

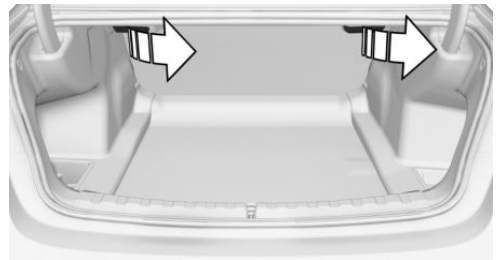

5. Fold the rear seat backrest forward.



Folding back the backrest

Return the rear seat backrest to the seat position and engage it.

Folding down the center section

1. Fold down the center head restraint.
2. Pull lever and fold the center section forward.

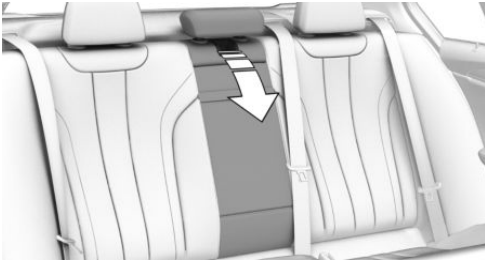

With an emergency wheel: enlarging the cargo area

Principle

The emergency wheel and any related components can be temporarily removed to enlarge the cargo area.

Removing the emergency wheel and the storage compartments

1. To remove the cargo area floor, pull it upward directly behind the rear backrests.

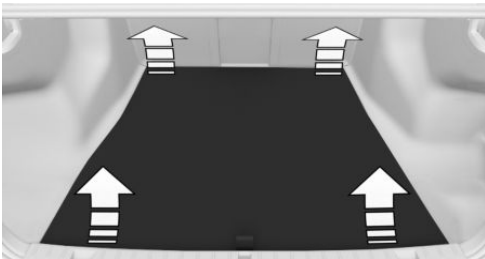

2. Remove tool holder and emergency wheel, refer to page [346](#).

3. Loosen the ratchet strap from the lashing eyes.
4. Remove the storage compartment.

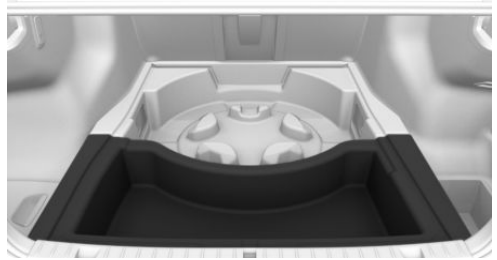

5. Remove the storage well.

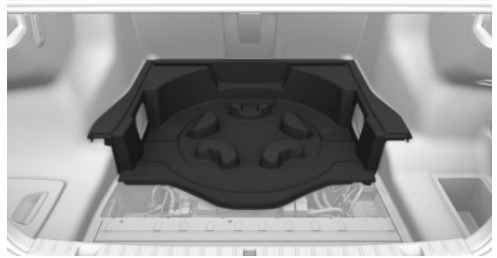

6. Insert the cargo floor panel.

Inserting the emergency wheel and the storage compartments

Proceed in reverse order to insert the emergency wheel and the storage compartments.

Things to remember when driving

Vehicle features and options

This chapter describes all standard, country-specific and optional features offered with the series. It also describes features and functions that are not necessarily available in your vehicle, e.g., due to the selected options or country versions. This also applies to safety-related functions and systems. When using these functions and systems, the applicable laws and regulations must be observed.

Break-in

General information

Moving parts need to begin working together smoothly.

The following instructions will help you to achieve a long vehicle life and good efficiency.

During break-in, do not use the Launch Control.

Safety information

Warning

Due to new parts and components, safety and driver assistance systems can react with a delay. There is a risk of accident. After installing new parts or with a new vehicle, drive conservatively and intervene early if necessary. Observe the break-in procedures of the respective parts and components.

Engine, transmission, and axle drive

Up to 1,200 miles/2,000 km

Do not exceed the maximum engine and road speed:

- ▶ For gasoline engine 4,500 rpm and 100 mph/160 km/h.

Avoid full throttle or kickdown under all circumstances.

From 1,200 miles/2,000 km

The engine and vehicle speed can gradually be increased.

Tires

Tire traction is not optimal due to manufacturing circumstances when tires are brand-new; they achieve their full traction potential after a break-in time.

Drive conservatively for the first 200 miles/300 km.

Brake system

Brake discs and brake pads only reach their full effectiveness after approx. 300 miles/500 km. Drive moderately during this break-in period.

Following part replacement

Observe the break-in procedures again, if components mentioned above are replaced.

General driving notes

Closing the trunk lid

Safety information

Warning

An open trunk lid protrudes from the vehicle and can endanger occupants and other road users or damage the vehicle in the event of an accident, braking or evasive maneuvers. In addition, exhaust fumes may enter the vehicle interior. There is a risk of injury or risk of damage to property. Do not drive with the trunk lid open.

Driving with the trunk lid open

If driving with the tailgate open cannot be avoided:

- ▶ Close all windows and the glass sunroof.
- ▶ Greatly increase the blower output.
- ▶ Drive moderately.

Hot exhaust gas system

Warning

High temperatures can occur underneath the body, for instance caused by the exhaust gas system, while driving. Contact with the exhaust gas system can cause burns. There is a risk of injury. Do not touch the hot exhaust gas system, including the exhaust pipe.

Warning

If combustible materials, such as leaves or grass, come in contact with hot parts of the exhaust gas system, these materials can ignite. There is a risk of fire and an injury hazard. Do not remove the heat shields installed and never apply undercoating to them. Make sure that no combustible materials can come in contact with

hot vehicle parts while driving, at idle or during parking.

Mobile communication devices in the vehicle

Warning

Vehicle electronics and mobile phones can influence one another. There is radiation due to the transmission operations of mobile phones. There is a risk of injury or risk of damage to property. If possible, in the car's interior use only mobile phones with direct connections to an external antenna in order to exclude mutual interference and deflect the radiation from the car's interior.

Aquaplaning

On wet or slushy roads, a wedge of water can form between the tires and road surface.

This phenomenon is referred to as aquaplaning. It is characterized by a partial or complete loss of contact between the tires and the road surface, ultimately undermining your ability to steer and brake the vehicle.

Driving through water

General information

When driving through water, follow the following:

- ▶ Deactivate Auto Start/Stop function.
- ▶ Drive through calm water only.
- ▶ Drive through water only if it is not deeper than maximum 9.8 inches/25 cm.
- ▶ Drive through water no faster than walking speed, up to 3 mph/5 km/h.

Safety information

NOTICE

When driving too quickly through too deep water, water can enter into the engine compartment, the electrical system or the transmission. There is a risk of damage to property, among other potential damage. When driving through water, do not exceed the maximum indicated water level and the maximum speed for driving through water.

Braking safely

General information

The vehicle is equipped with an Antilock Braking System ABS as a standard feature.

Perform emergency braking in situations that require such.

Steering is still responsive. You can still avoid any obstacles with a minimum of steering effort.

Pulsation of the brake pedal and sounds from the hydraulic circuits indicate that the Antilock Braking System ABS is in its active mode.

In certain braking situations, the perforated brake discs can emit functional noises. However, functional noises have no effect on the performance and operational reliability of the brake.

Objects in the area around the pedals

Warning

Objects in the driver's floor area can limit the pedal distance or block a depressed pedal. There is a risk of accident. Stow objects in the vehicle such that they are secured and cannot enter into the driver's floor area. Use floor mats that are suitable for the vehicle and can be safely attached to the floor. Do not use loose floor mats and do not layer several floor mats. Make sure that there is sufficient clearance for

the pedals. Ensure that the floor mats are securely fastened again after they were removed, for instance for cleaning.

Driving in wet conditions

In case of wet roads, exposure to road salt, in heavy rain, gently press the brake pedal every few kilometers.

Ensure that this action does not endanger other road users.

The heat generated during braking dries brake discs and brake pads and protects them against corrosion.

In this way braking efficiency will be available when you need it.

Hills

General information

Drive long or steep downhill gradients in the gear that requires least braking effort. Otherwise, the brake system may overheat and reduce braking effect.

You can increase the engine's braking effect by shifting down, going all the way to first gear, if needed.

Safety information

Warning

Light but consistent pressure on the brake pedal can lead to high temperatures, brakes wearing out and possibly even brake system failure. There is a risk of accident. Avoid placing excessive stress on the brake system.

Warning

In idle state or with the engine switched off, safety functions, for instance engine braking effect, braking assistance and steering assistance, may not be available. There is a risk of

accident. Do not attempt to drive in idle state or with the engine switched off.

Brake disc corrosion

Corrosion on the brake discs and contamination on the brake pads are increased by the following circumstances:

- ▷ Low mileage.
- ▷ Extended periods when the vehicle is not used at all.
- ▷ Infrequent use of the brakes.
- ▷ Aggressive, acidic, or alkaline cleaning agents.

Corrosion buildup on the brake discs will cause a pulsating effect on the brakes in their response - generally this cannot be corrected.

Condensation water under the parked vehicle

When using the automatic climate control, condensation water develops and collects underneath the vehicle.

M340i with M Technology package: ground clearance

NOTICE

If the ground clearance is insufficient, e.g., curbs or underground garage entrances, contact with vehicle parts, e.g., spoiler, and the underbody may occur. There is a risk of damage to property, among other potential damage. Ensure that there is sufficient ground clearance available.

Roof-mounted luggage rack

General information

Roof racks are available as special accessories.

Safety information

Warning

When driving with a roof load, for instance with roof-mounted luggage rack, the vehicle's center of gravity is higher, which increases the risk of the vehicle tipping in critical driving situations. There may be a risk of accident or risk of damage to property. Driving with roof load only with activated Dynamic Stability Control.

Roof drip rail with flaps

The fixing points are located in the roof drip rail above the doors.

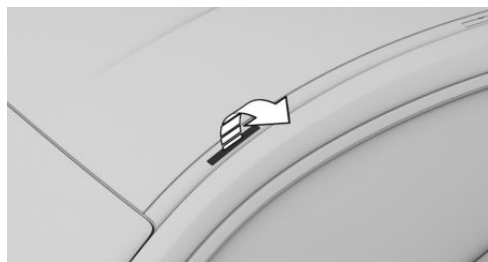

Fold the cover outward.

Mounting

Follow the installation instructions of the roof rack.

Be sure that adequate clearance is maintained for tilting and opening the glass sunroof.

Loading

Because roof-mounted luggage racks raise the vehicle's center of gravity when loaded, they

have a major effect on vehicle handling and steering response.

Therefore, note the following when loading and driving:

- ▷ Do not exceed the approved roof/axle weights and the approved gross vehicle weight.
- ▷ Be sure that adequate clearance is maintained for tilting and opening the glass sunroof.
- ▷ Distribute the roof load uniformly.
- ▷ The roof load should not extend past the loading area.
- ▷ Always place the heaviest pieces on the bottom.
- ▷ Secure the roof luggage firmly, for instance using ratchet straps.
- ▷ Do not let objects project into the opening path of the trunk lid.
- ▷ Drive cautiously and avoid sudden acceleration and braking maneuvers. Take corners gently.

Driving on racetracks

Warning

The vehicle is not designed for use in M Sport or motor sport type competition. There is a risk of accident. Do not use the vehicle for M Sport or motor sport type competitions.

Higher mechanical and thermal loads during racetrack operation lead to increased wear. Use of the vehicle in M Sport or motor sport type competition is an improper use of the vehicle and may affect your warranty coverage. Please consult the “New Vehicle Limited Warranty” Booklet for further information on warranty matters.

Have vehicle checked by a dealer’s service center or another qualified service center or repair shop before and after driving on a racetrack.

Saving fuel

Vehicle features and options

This chapter describes all standard, country-specific and optional features offered with the series. It also describes features and functions that are not necessarily available in your vehicle, e.g., due to the selected options or country versions. This also applies to safety-related functions and systems. When using these functions and systems, the applicable laws and regulations must be observed.

Reducing fuel consumption

General information

The vehicle contains advanced technologies for the reduction of consumption and emission values.

The fuel consumption depends on various factors, such as driving style, road conditions, maintenance or environmental factors.

Carrying out certain measures, such as a moderate driving style and regular maintenance, can influence fuel consumption and the environmental impact.

Remove unnecessary cargo

Additional weight increases fuel consumption.

Remove attached parts following use

Remove roof-mounted which are no longer required following use.

Attached parts on the vehicle impair the aerodynamics and increase the fuel consumption.

Close the windows and glass sunroof

Driving with the glass sunroof and windows open results in increased drag and raises fuel consumption.

Tires

General information

Tires can affect consumption in various ways, for instance tire size may influence consumption.

Check the tire pressure regularly

Check and, if needed, correct the tire inflation pressure at least twice a month and before starting on a long trip.

Low tire inflation pressure increases rolling resistance and thus raises fuel consumption and tire wear.

Observe the correct tire inflation pressure as well as the ECO tire inflation pressure, where applicable.

Additional information:

Tire pressure specifications, refer to page [316](#).

Drive away without delay

Do not wait for the engine to warm-up while the vehicle remains stationary. Start driving right away, but at moderate RPM.

This is the fastest way of warming the cold engine up to operating temperature.

Proactive driving

Driving smoothly and proactively reduces fuel consumption.

Avoid unnecessary acceleration and braking.

By maintaining a suitable distance to the vehicle driving ahead of you.

Avoid high RPM

Driving at low engine speeds lowers fuel consumption and reduces wear.

If necessary, observe the vehicle's gear shift indicator.

Using coasting overrun mode

When approaching a red light, take your foot off the accelerator and let the vehicle coast to a halt.

For going downhill take your foot off the accelerator and let the vehicle roll.

The fuel supply is interrupted in coasting overrun mode.

Switch off the engine during longer stops

Switching off the engine

Switch off the engine during longer stops, for instance at traffic lights, railroad crossings or in traffic jam.

Auto Start/Stop function

The Auto Start/Stop function of the vehicle automatically switches off the engine during a stop.

If the engine is switched off and then restarted rather than leaving the engine running constantly, fuel consumption and emissions are reduced. Savings can begin within a few seconds of switching off the engine.

Switch off any functions that are not currently needed

Functions such as seat heating and the rear window defroster require a lot of energy and increase fuel consumption, especially in city and stop-and-go traffic.

Switch off these functions if they are not needed.

The ECO PRO driving mode supports the energy conserving use of comfort features. These functions are automatically deactivated partially or completely.

Have maintenance carried out

Have the vehicle maintained regularly to achieve optimal vehicle efficiency and service life. BMW recommends that maintenance work be performed by a BMW service center.

Also refer to BMW Maintenance System.

ECO PRO

Principle

ECO PRO supports a driving style that saves on consumption. For this purpose, the engine control and comfort features, for instance the climate control output, are adjusted.

Steptronic transmission: under certain conditions the engine is automatically decoupled from the transmission in the D selector lever position. The vehicle continues traveling with the engine idling to reduce consumption. The D selector lever position remains engaged.

In addition, context-sensitive information, ECO PRO tips, are displayed to assist with an efficient driving style.

The achieved extended range is displayed in the instrument cluster as bonus range.

General information

The system includes the following EfficientDynamics functions and EfficientDynamics displays:

- ▷ ECO PRO bonus range.
- ▷ ECO PRO seat climate control.
- ▷ ECO PRO climate control.
- ▷ ECO PRO light and sight.
- ▷ ECO PRO Limit.
- ▷ Coasting driving condition.
- ▷ Driving style analysis.

Overview



ECO PRO

Button

Activating ECO PRO

ECO PRO

Press the button. ECO PRO is displayed in the instrument cluster.

Configuring ECO PRO INDIVIDUAL

Via the Driving Dynamics Control

1. Activate ECO PRO.
2. "ECO PRO INDIVIDUAL"

Via iDrive

1. "CAR"
2. "Settings"
3. "Driving mode"
4. "ECO PRO INDIVIDUAL"
5. Select the desired setting.

ECO PRO limit speed

- ▷ "ECO PRO speed": activate ECO PRO speed.
An ECO PRO tip is displayed if the speed of the set ECO PRO limit is exceeded.
- ▷ "Notification at:"
Set the desired speed for the ECO PRO speed.

Activating/deactivating ECO PRO functions

The following ECO PRO functions can be activated/deactivated:

- ▷ "Coasting"
- ▷ "ECO PRO seat heating"
- ▷ "ECO PRO climate control"
- ▷ "ECO PRO light and sight"

Coasting

Efficiency can be optimized by disengaging or switching off the engine and coasting with the engine idling.

ECO PRO seat climate control

The activation of ECO PRO will reduce the output of the seat heating.

ECO PRO climate control

Climate control is set to be efficient.

This means, it is possible to deviate slightly from the set temperature or to heat or cool down the car's interior more slowly, to economize on consumption.

ECO PRO light and sight

The output of exterior mirror heating and rear window defroster is reduced.

Resetting the settings

Reset ECO PRO INDIVIDUAL to the standard settings:

"Reset to ECO PRO STANDARD"

Displays in the instrument cluster

General information

When ECO PRO driving mode is activated, the display switches to a special configuration.

ECO PRO bonus range



A modified driving style helps you extend your driving distance.

The range extension can be displayed as the bonus range in the instrument cluster.

The efficiency display includes the bonus range.

If the bonus range appears in gray, the current driving style is inefficient.

The display turns blue as soon as all conditions for efficient driving are met.

The intervals for resetting the bonus range depend on the settings of the trip data.

Consumption display

Instrument cluster with enhanced features:

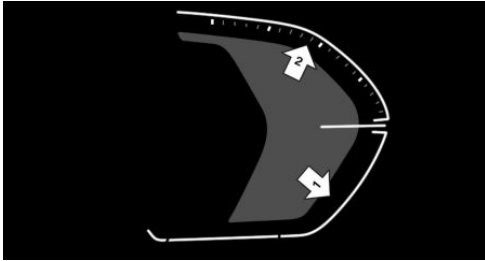

Instrument cluster without enhanced features:



A pointer in the consumption display informs about the current driving style:

- ▷ The current consumption in relation to the average consumption is displayed.
- ▷ Pointer in the area of arrow 1: display of the energy recovered by coasting or when braking.
- ▷ Pointer in the area of arrow 2: display when accelerating.

If the acceleration is inefficient, the area between the average consumption and the current consumption is colored red.

In addition, the following information is displayed, depending on the situation:

- ▷ Depending on the equipment: the total distance driven while coasting.
- ▷ The total time that the engine has been switched off during automatic engine stops.
- ▷ A gear shift indicator recommending the use of a more efficient gear.

Indications on the Control Display

General information

Information about the current effectiveness of the ECO PRO functions can be displayed as energy flow.

Displaying energy flow information

1. "CAR"
2. "Driving information"
3. "Energy flow"

The following functions are displayed:

- ▷ Auto Start/Stop function.
- ▷ Energy recovery.
- ▷ Coasting.

Engine-Off / Coasting

Principle

Under certain conditions the engine is automatically decoupled from the transmission in the D selector lever position. The vehicle continues traveling with the engine idling to reduce consumption. Selector lever position D remains engaged. This driving condition is referred to as coasting.

Under certain conditions, the engine will not be operated at idle while coasting but switched off automatically in vehicles with Mild-Hybrid technology. When the engine is switched off, the lettering READY is displayed in the instrument cluster. The vehicle continues to coast without consuming fuel. This driving condition is referred to as engine-off coasting.

As soon as the brake or accelerator pedal is depressed, the engine is automatically coupled to the transmission again.

General information

Coasting is a component of the ECO PRO driving mode.

Coasting is automatically activated when ECO PRO driving mode is called via the Driving Dynamics Control.

A proactive driving style helps the driver to use the function often and supports the efficient effect of coasting.

Functional requirements

The function is available in the speed range from approx. 16 mph/25 km/h to 100 mph/160 km/h.

The function is active if the following conditions are met:

- ▶ The accelerator pedal is not depressed or the accelerator pedal is released.
- ▶ Brake pedal not depressed or only slightly depressed.

- ▶ The selector lever is in selector lever position D.
- ▶ Engine and transmission are at operating temperature.
- ▶ Active Cruise Control with Stop&Go function, ACC, not activated.

Operation via shift paddles

Principle

The coasting driving condition can be influenced with the shift paddles.

Activating/deactivating coasting via shift paddles

1. Shift to the highest gear by pulling the right shift paddle.
2. To activate coasting mode, actuate the right shift paddle again.

To deactivate, actuate the left shift paddle.

Display

Display in the instrument cluster

 The coasting distance traveled is indicated in coasting mode.

Indications on the Control Display

The coasting mode is displayed under energy flow while driving.

The distance traveled in coasting mode is displayed in the trip data.

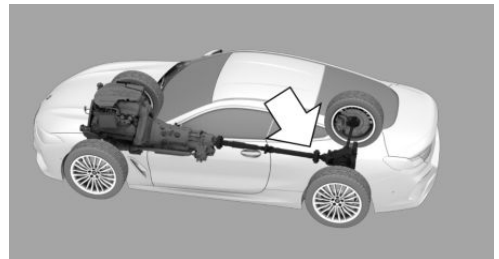

Color code blue: coasting mode.

Displaying energy flow information

1. "CAR"
2. "Driving information"
3. "Energy flow"

System limits

The function is not available under one of the following conditions.

- ▷ DSC OFF or TRACTION activated.
- ▷ Driving in the dynamic limit range and on steep uphill or downhill grades.
- ▷ Battery charge status temporarily too low or vehicle electrical system drawing excessive current.

Driving style analysis

Principle

The function helps develop an especially efficient driving style and to conserve fuel.

For this purpose, the driving style is analyzed. The assessment is done in various categories and is displayed on the Control Display.

This display will help you adjust your driving style and save some fuel.

General information

The current trip is assessed.

To assist with an efficient driving style, ECO PRO tips are displayed during driving.

The range of the vehicle can be extended by adjusting your driving style.

This gain in range is displayed as a bonus range in the instrument cluster and on the Control Display.

Functional requirement

This function is available in ECO PRO driving mode.

Calling up the Driving style analysis

1. "CAR"
2. "Driving information"
3. "Driving style analysis"

Display on the Control Display

The display of the Driving style analysis shows the efficiency of the Driving style.

The more efficient the driving style, the more bars are displayed in color and the faster the bonus range increases.

In contrast, a reduced number of bars will be displayed with an inefficient driving style.

Refueling

Vehicle features and options

This chapter describes all standard, country-specific and optional features offered with the series. It also describes features and functions that are not necessarily available in your vehicle, e.g., due to the selected options or country versions. This also applies to safety-related functions and systems. When using these functions and systems, the applicable laws and regulations must be observed.

Follow the following when refueling

General information

Follow the fuel recommendation prior to refueling.

When refueling, insert the filler nozzle completely into the filler pipe. Lifting up the filler nozzle during refueling causes:

- ▷ Premature switching off.
- ▷ Reduced return of the fuel vapors.

The fuel tank is full when the filler nozzle clicks off the first time.

Make sure that the fuel cap is closed properly after refueling, otherwise the emissions warning light may light up.

Follow safety regulations posted at the filling station.

Additional information:

Fuel quality, refer to page [350](#).

Safety information

NOTICE

With a driving distance of less than 30 miles/50 km the engine may no longer have sufficient fuel. Engine functions are not ensured anymore. There is a risk of damage to property, among other potential damage. Refuel promptly.

NOTICE

Fuels are toxic and aggressive. Overfilling of the fuel tank can damage the fuel system. Painted surfaces may be damaged by contact with fuel. Escaping fuel can harm the environment. There is a risk of damage to property, among other potential damage. Avoid overfilling.

Fuel cap

Opening

1. To open the fuel filler flap, press on the rear edge, arrow. The fuel filler flap opens.



2. Turn the fuel cap counterclockwise.

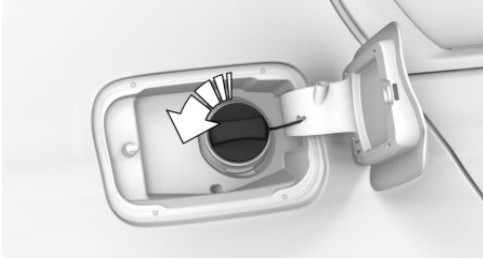

3. Place the fuel cap in the bracket attached to the fuel filler flap.

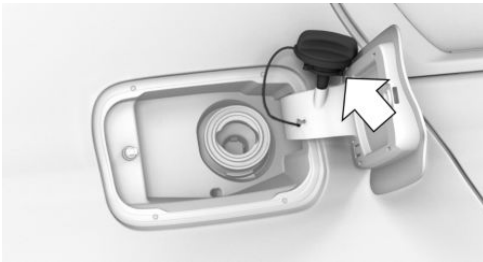

Have fuel filler flap unlocked by a dealer's service center or another qualified service center or repair shop.

Closing

Warning

The retaining strap of the fuel cap can be jammed and crushed during closing. The cap cannot be correctly closed. Fuel or fuel vapors can escape. There is a risk of injury or risk of damage to property. Pay attention that the retaining strap is not jammed or crushed when closing the cap.

1. Fit the fuel cap and turn it clockwise until you clearly hear a click.
2. Press on the fuel filler flap until it engages.

Emergency unlocking

It may be necessary in certain situations to unlock the fuel filler flap manually, for instance with an electrical fault.

Wheels and tires

Vehicle features and options

This chapter describes all standard, country-specific and optional features offered with the series. It also describes features and functions that are not necessarily available in your vehicle, e.g., due to the selected options or country versions. This also applies to safety-related functions and systems. When using these functions and systems, the applicable laws and regulations must be observed.

Tire pressure

General information

The tire characteristics and tire pressure influence the following:

- ▷ The service life of the tires.
- ▷ Driving safety.
- ▷ Driving comfort.
- ▷ Fuel consumption.

Safety information

Warning

A tire with too little or no tire inflation pressure may heat up significantly and sustain damage. This will have a negative impact on aspects of handling, such as steering and braking response. There is a risk of accident. Regularly check the tire inflation pressure, and correct it as needed, for instance twice a month and before a long trip.

Tire pressure specifications

In the tire inflation pressure table

The tire inflation pressure table, refer to page 316, contains all tire inflation pressure specifications for the specified tire sizes at the ambient temperature. The tire inflation pressure values apply to tire sizes approved by the manufacturer of the vehicle for the vehicle type.

To identify the correct tire inflation pressure, please note the following:

- ▷ Tire sizes of your vehicle.
- ▷ Maximum speed for driving.

On the Control Display

The current tire inflation pressure values and the intended tire inflation pressure values for the mounted tires can be displayed on the Control Display.

To ensure that they are displayed correctly, the tire sizes must be stored in the system and must have been set for the mounted tires.

The current tire inflation pressure value is located on each tire.

The reference tire inflation pressure value is located in the lower area of the Control Display.

Checking the tire pressure

General information

Tires heat up while driving. The tire pressure increases with the tire temperature.

Tires have a natural, consistent tire pressure loss.

The displays of inflation devices may under-read by up to 0.1 bar/2 psi.

Checking using tire inflation pressure specifications in the tire inflation pressure table

1. Determine the intended tire inflation pressure levels for the mounted tires.
2. Check the tire inflation pressure in all four tires, using a pressure gage, for example.
3. Correct the tire inflation pressure if the actual tire inflation pressure deviates from the intended tire inflation pressure.
4. Check whether all valve caps are screwed onto the tire valves.

The tire inflation pressure specifications in the tire inflation pressure table only relate to cold tires or tires at the same temperature as the ambient temperature.

Only check the tire inflation pressure levels when the tires are cold, i.e.:

- ▶ A driving distance of max. 1.25 miles/2 km has not been exceeded.
- ▶ If the vehicle has not moved again for at least 2 hours after a trip.

Check the tire inflation pressure of the emergency wheel in the cargo area regularly, and correct it as needed.

Checking using the tire inflation pressure specifications on the Control Display

1. "CAR"
2. "Vehicle status"
3. (⚠) "Tire Pressure Monitor"
4. Check whether the current tire inflation pressure levels deviate from the intended tire pressure value.
5. Correct the tire inflation pressure if the actual tire inflation pressure deviates from the intended tire inflation pressure.

After correcting the tire pressure

With runflat tires:

Reinitialize the Flat Tire Monitor.

With Tire Pressure Monitor:

The corrected tire inflation pressures are applied automatically. Make sure that the correct tire settings have been made.

With tires that cannot be found in the tire pressure values on the Control Display, reset the Tire Pressure Monitor TPM.

Tire inflation pressures up to 100 mph/160 km/h

For speeds of up to 100 mph/160 km/h and for optimum driving comfort, note the pressure values in the tire inflation pressure table and adjust as necessary.



These pressure values can also be found on the tire pressure label on the driver's door pillar.

Do not exceed a speed of 100 mph/160 km/h.

Tire pressure values up to 100 mph/160 km/h

330i, 330i xDrive

| Tire size | Pressure specifications in bar/PSI | |
|---|------------------------------------|----------|
| Specifications in bar/PSI with cold tires | | |
| 225/50 R 17 98 H XL M+S | 2.2 / 32 | 2.4 / 35 |

| Tire size | Pressure specifications in bar/PSI | |
|-----------------------------------|---|----------|
| 225/45 R 18 95 H XL A/S | 2.2 / 32 | 2.7 / 39 |
| 225/45 R 18 95 H XL M+S | | |
| 225/40 R 19 93 H XL A/S | 2.4 / 35 | 2.9 / 42 |
| Front: 225/45 R 18 95 Y XL | 2.2 / 32 | - |
| Rear: 255/40 R 18 99 Y XL | - | 2.3 / 33 |
| Front: 225/40 R 19 93 Y XL | 2.4 / 35 | - |
| Rear: 255/35 R 19 96 Y XL | - | 2.6 / 38 |
| Front: 225/35 R 20 90 Y XL | 2.7 / 39 | - |
| Rear: 255/30 R 20 92 Y XL | - | 3.1 / 45 |
| Front: 225/45 R 18 95 V XL M+S | 2.2 / 32 | - |
| Rear: 255/40 R 18 99 V XL M+S | - | 2.3 / 33 |
| Front: 225/40 R 19 93 H XL M+S | 2.4 / 35 | - |
| Rear: 255/35 R 19 96 H XL M+S | - | 2.6 / 38 |
| Emergency wheel: | Speed up to a max. of 50 mph / 80 km/h | |
| T 135/80 R 17 102 M | 4.2 / 60 | |

M340i, M340i xDrive

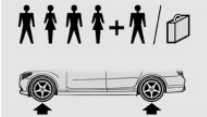
| Tire size | Pressure specifications in bar/PSI | |
|---|---|----------|
| Specifications in bar/PSI with cold tires |  | |
| 225/50 R 17 98 H XL M+S | 2.2 / 32 | 2.4 / 35 |
| 225/45 R 18 95 H XL A/S | 2.5 / 36 | 2.7 / 39 |
| 225/45 R 18 95 H XL M+S | | |
| 225/40 R 19 93 H XL A/S | 2.6 / 38 | 2.9 / 42 |
| Front: 225/45 R 18 95 Y XL | 2.5 / 36 | - |
| Rear: 255/40 R 18 99 Y XL | - | 2.5 / 36 |
| Front: 225/40 R 19 93 Y XL | 2.6 / 38 | - |
| Rear: 255/35 R 19 96 Y XL | - | 2.6 / 38 |
| Front: 225/35 R 20 90 Y XL | 2.9 / 42 | - |
| Rear: 255/30 R 20 92 Y XL | - | 3.0 / 44 |
| Front: 225/45 R 18 95 V XL M+S | 2.5 / 36 | - |
| Rear: 255/40 R 18 99 V XL M+S | - | 2.5 / 36 |
| Front: 225/40 R 19 93 H XL M+S | 2.6 / 38 | - |

| Tire size | Pressure specifications in bar/PSI | |
|-------------------------------|--|----------|
| Rear: 255/35 R 19 96 H XL M+S | - | 2.6 / 38 |
| Emergency wheel: | Speed up to a max. of 50 mph / 80 km/h | |
| T 135/80 R 17 102 M | 4.2 / 60 | |

Tire inflation pressures at max. speeds above 100 mph/160 km/h

Warning

In order to drive at maximum speeds in excess of 100 mph/160 km/h, please observe, and, if necessary, adjust tire pressures for speeds exceeding 100 mph/160 km/h from the relevant table on the following pages. Otherwise, tire damage and accidents could occur.

For speeds over 100 mph/160 km/h and for optimum driving comfort, note the pressure values in the tire inflation pressure table and adjust as necessary.

Tire pressure values over 100 mph/160 km/h

330i, 330i xDrive

Without high-speed tuning feature

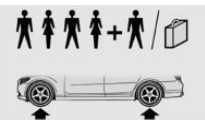
| Tire size | Pressure specifications in bar/PSI | |
|---|---|----------|
| Specifications in bar/PSI with cold tires |  | |
| 225/50 R 17 98 H XL M+S | 2.2 / 32 | 2.7 / 39 |

| Tire size | Pressure specifications in bar/PSI | |
|--------------------------------|--|----------|
| 225/45 R 18 95 H XL A/S | 2.5 / 36 | 3.0 / 44 |
| 225/45 R 18 95 H XL M+S | | |
| 225/40 R 19 93 H XL | 2.7 / 39 | 3.2 / 46 |
| Front: 225/45 R 18 95 Y XL | 2.2 / 32 | - |
| Rear: 255/40 R 18 99 Y XL | - | 2.3 / 33 |
| Front: 225/40 R 19 93 Y XL | 2.4 / 35 | - |
| Rear: 255/35 R 19 96 Y XL | - | 2.6 / 38 |
| Front: 225/35 R 20 90 Y XL | 2.7 / 39 | - |
| Rear: 255/30 R 20 92 Y XL | - | 3.1 / 45 |
| Front: 225/45 R 18 95 V XL M+S | 2.5 / 36 | - |
| Rear: 255/40 R 18 99 V XL M+S | - | 2.6 / 38 |
| Front: 225/40 R 19 93 H XL M+S | 2.7 / 39 | - |
| Rear: 255/35 R 19 96 H XL M+S | - | 2.9 / 42 |
| Emergency wheel: | Speed up to a max. of 50 mph / 80 km/h | |
| T 135/80 R 17 102 M | 4.2 / 60 | |

With high-speed tuning feature

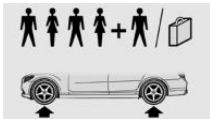
| Tire size | Pressure specifications in bar/PSI | |
|---|---|----------|
| Specifications in bar/PSI with cold tires |  | |
| 225/50 R 17 98 H XL M+S | 2.2 / 32 | 2.7 / 39 |
| 225/45 R 18 95 H XL M+S | 2.5 / 36 | 3.0 / 44 |
| Front: 225/45 R 18 95 Y XL | 2.5 / 36 | - |
| Rear: 255/40 R 18 99 Y XL | - | 2.6 / 38 |
| Front: 225/40 R 19 93 Y XL | 2.7 / 39 | - |
| Rear: 255/35 R 19 96 Y XL | - | 3.0 / 44 |
| Front: 225/35 R 20 90 Y XL | 3.0 / 44 | - |
| Rear: 255/30 R 20 92 Y XL | - | 3.4 / 49 |
| Front: 225/45 R 18 95 V XL M+S | 2.8 / 41 | - |
| Rear: 255/40 R 18 99 V XL M+S | - | 2.9 / 42 |
| Front: 225/40 R 19 93 H XL M+S | 2.7 / 39 | - |
| Rear: 255/35 R 19 96 H XL M+S | - | 3.0 / 44 |
| Emergency wheel: T 135/80 R 17 102 M | Speed up to a max. of 50 mph / 80 km/h | |
| | 4.2 / 60 | |

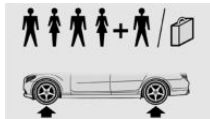
| Tire size | Pressure specifications in bar/PSI | |
|---|---|----------|
| Specifications in bar/PSI with cold tires |  | |
| 225/50 R 17 98 H XL M+S | 2.4 / 35 | 2.7 / 39 |
| 225/45 R 18 95 H XL A/S | 2.7 / 39 | 3.0 / 44 |
| 225/45 R 18 95 H XL M+S | | |
| 225/40 R 19 93 H XL A/S | 2.9 / 42 | 3.2 / 46 |
| Front: 225/45 R 18 95 Y XL | 2.5 / 36 | - |
| Rear: 255/40 R 18 99 Y XL | - | 2.5 / 36 |
| Front: 225/40 R 19 93 Y XL | 2.6 / 38 | - |
| Rear: 255/35 R 19 96 Y XL | - | 2.6 / 38 |
| Front: 225/35 R 20 90 Y XL | 2.9 / 42 | - |
| Rear: 255/30 R 20 92 Y XL | - | 3.0 / 44 |
| Front: 225/45 R 18 95 V XL M+S | 2.7 / 39 | - |
| Rear: 255/40 R 18 99 V XL M+S | - | 2.7 / 39 |
| Front: 225/40 R 19 93 H XL M+S | 2.9 / 42 | - |

M340i, M340i xDrive

Without high-speed tuning feature

| Tire size | Pressure specifications in bar/PSI | |
|-------------------------------|--|----------|
| Rear: 255/35 R 19 96 H XL M+S | - | 2.9 / 42 |
| Emergency wheel: | Speed up to a max. of 50 mph / 80 km/h | |
| T 135/80 R 17 102 M | 4.2 / 60 | |

With high-speed tuning feature

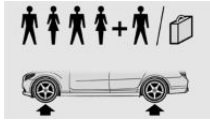
| Tire size | Pressure specifications in bar/PSI | |
|---|---|----------|
| Specifications in bar/PSI with cold tires |  | |
| 225/50 R 17 98 H XL M+S | 2.4 / 35 | 2.7 / 39 |
| 225/45 R 18 95 H XL M+S | 2.7 / 39 | 3.1 / 45 |
| Front: 225/45 R 18 95 Y XL | 2.8 / 41 | - |
| Rear: 255/40 R 18 99 Y XL | - | 2.8 / 41 |
| Front: 225/40 R 19 93 Y XL | 3.0 / 44 | - |
| Rear: 255/35 R 19 96 Y XL | - | 3.0 / 44 |
| Front: 225/35 R 20 90 Y XL | 3.4 / 49 | - |
| Rear: 255/30 R 20 92 Y XL | - | 3.4 / 49 |
| Front: 225/45 R 18 95 V XL M+S | 3.0 / 44 | - |
| Rear: 255/40 R 18 99 V XL M+S | - | 3.0 / 44 |

| Tire size | Pressure specifications in bar/PSI | |
|--------------------------------|--|----------|
| Front: 225/40 R 19 93 H XL M+S | 3.0 / 44 | - |
| Rear: 255/35 R 19 96 H XL M+S | - | 3.0 / 44 |
| Emergency wheel: | Speed up to a max. of 50 mph / 80 km/h | |
| T 135/80 R 17 102 M | 4.2 / 60 | |

Tire marking

Tire size

245/45 R 18 96 Y

245: nominal width in mm

45: aspect ratio in %

R: radial tire code

18: rim diameter in inches

96: load bearing capacity

Y: speed code letter

ZR tires: reinforced radial tire for speeds exceeding 150 mph/240 km/h

Maximum tire load

Maximum tire load is the maximum permissible weight for which the tire is approved.

Locate the maximum tire load on the tire sidewall and the Gross Axle Weight Rating – GAWR – on the certification label on the driver door B-pillar.

Divide the tire load by 1.1. It must be greater than one-half of the vehicle's Gross Axle Weight Rating – GAWR. Note, front vs. rear GAWR and tire loads, respectively.

Speed letter

| Designation | Maximum speed |
|-------------|------------------------|
| Q | up to 100 mph/160 km/h |
| R | up to 106 mph/170 km/h |
| S | up to 112 mph/180 km/h |
| T | up to 118 mph/190 km/h |
| H | up to 131 mph/210 km/h |
| V | up to 150 mph/240 km/h |
| W | up to 167 mph/270 km/h |
| Y | up to 186 mph/300 km/h |
| (Y) | above 186 mph/300 km/h |

Tire Identification Number

DOT Code: DOT xxx xxx 1921

xxx: manufacturer code for the tire brand

xxx: tire size and tire design

1921: tire age

Tires with DOT codes meet the guidelines of the U.S. Department of Transportation.

Tire age

Recommendation

Regardless of the tire tread depth, replace tires at least every 6 years.

Manufacture date

You can find the manufacture date of the tire on the tire sidewall.

| Designation | Manufacture date |
|--------------|------------------|
| DOT ... 1921 | 19th week 2021 |

Uniform Tire Quality Grading

Quality grades can be found where applicable on the tire sidewall between tread shoulder and maximum section width.

E.g.: Treadwear 200; Traction AA; Temperature A

DOT Quality Grades

Treadwear

Traction AA A B C

Temperature A B C

All passenger vehicle tires must conform to Federal Safety Requirements in addition to these grades.

Treadwear

The treadwear grade is a comparative rating based on the wear rate of the tire when tested under controlled conditions on a specified government test course. E.g., a tire graded 150 would wear one and one-half, 1 g, times as well on the government course as a tire graded 100. The relative performance of tires depends upon the actual conditions of their use, however, and may depart significantly from the norm due to variations in driving habits, service practices and differences in road characteristics and climate.

Traction

The traction grades, from highest to lowest, are AA, A, B, and C.

Those grades represent the tire's ability to stop on wet pavement as measured under controlled conditions on specified government test surfaces of asphalt and concrete. A tire marked C may have poor traction performance.

The traction grade assigned to this tire is based on straight-ahead braking traction tests, and does not include acceleration, cornering, hydroplaning, or peak traction characteristics.

Temperature

The temperature grades are A, the highest, B, and C, representing the tire's resistance to the generation of heat and its ability to dissipate heat when tested under controlled conditions on a specified indoor laboratory test wheel. Sustained high temperature can cause the material of the tire to degenerate and reduce tire life, and excessive temperature can lead to sudden tire failure. The grade C corresponds to a level of performance which all passenger car tires must meet under the Federal Motor Vehicle Safety Standard No. 109. Grades Band A represent higher levels of performance on the laboratory test wheel than the minimum required by law.

Warning

The temperature grade for this tire is established for a tire that is properly inflated and not overloaded. Excessive speed, underinflation, or excessive loading, either separately or in combination, can cause heat buildup and possible tire failure.

RSC – Run-flat tires

Run-flat tires, refer to page 326, are labeled with a circular icon containing the letters RSC marked on the sidewall.

M+S

Winter and all-season tires with better cold weather performance than summer tires.

Tire tread

Summer tires

Do not drive with a tire tread depth of less than 0.12 in/3 mm, otherwise there is an increased risk of aquaplaning.

Winter tires

Do not drive with a tire tread of less than 0.16 in/4 mm, as such tires are less suitable for winter operation.

Minimum tread depth

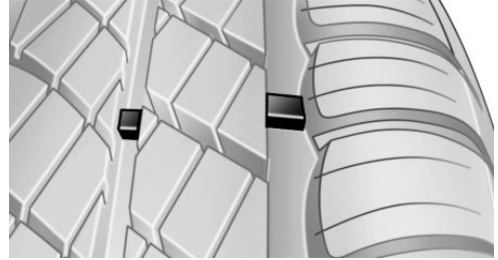

Wear indicators are distributed around the tire circumference. These wear indicators have the legally required minimum height of 0.063 in/1.6 mm.

The positions of the wear indicators are marked on the tire sidewall with TWI, Tread Wear Indicator.

Tire damage

General information

Inspect your tires regularly for damage, foreign objects lodged in the tread, and tread wear.

Driving over rough or damaged road surfaces, as well as debris, curbs and other obstacles can cause serious damage to wheels, tires and suspension parts. This is more likely to occur with low-profile tires, which provide less cushioning between the wheel and the road. Be careful to avoid road hazards and reduce your speed, especially if your vehicle is equipped with low-profile tires.

Indications of tire damage or other vehicle malfunctions:

- ▷ Unusual vibrations.
- ▷ Unusual tire or running noises.
- ▷ Unusual handling such as a strong tendency to pull to the left or right.

Damage can be caused by the following situations, for instance:

- ▷ Driving over curbs.
- ▷ Road damage.
- ▷ Tire pressure too low.
- ▷ Vehicle overloading.
- ▷ Incorrect tire storage.

Safety information

Warning

Damaged tires can lose tire inflation pressure, which can lead to loss of vehicle control. There is a risk of accident. If tire damage is suspected while driving, immediately reduce speed and stop. Have wheels and tires checked. For this purpose, drive carefully to the nearest dealer's service center or another qualified service center or repair shop. Have vehicle towed or transported as needed. Do not repair damaged tires, but have them replaced.

Warning

Tires can become damaged by driving over obstacles, e.g., curbs or road damage, at high speed. Larger wheels have a smaller tire cross-section. The smaller the tire cross-section, the higher the risk of tire damage. There may be a risk of accident and risk of damage to property. If possible, avoid driving over objects or road conditions that may damage tires, or drive over them slowly and carefully.

Changing wheels and tires

Mounting and wheel balancing

Have mounting and wheel balancing carried out by a dealer's service center or another qualified service center or repair shop.

Approved wheels and tires

General information

The following properties are recommended and approved by the manufacturer of the vehicle for the approved wheels and tires per vehicle type and special equipment:

- ▷ Wheel and tire combinations.
- ▷ Rim designs.
- ▷ Tire sizes.
- ▷ Tire brands.

You can ask a manufacturer service center or another qualified service center or repair shop about the approved wheels and tires for the vehicle and the special equipment.

Safety information

Warning

Wheels and tires which are not suitable for your vehicle can damage parts of the vehicle, for instance due to contact with the body due to tolerances despite the same official size rating. There is a risk of an accident. The manufacturer of your vehicle strongly suggests that you use wheels and tires that have been recommended by the vehicle manufacturer for your vehicle type.

⚠ Warning

Mounted steel wheels can cause technical problems, for instance unexpected loosening of the lug bolts and damage to the brake discs. There is a risk of accident. Do not mount steel wheels.

⚠ Warning

Incorrect wheel/tire combinations will impair the vehicle's handling characteristics and a variety of system functions, such as the Antilock Braking System (ABS) or Dynamic Stability Control. There is a risk of accident. To maintain good handling and vehicle response, use only tires with a single tread configuration from a single manufacturer. The manufacturer of the vehicle recommends that you use wheels and tires that have been recommended by the vehicle manufacturer for your vehicle type. Following tire damage, have the original wheel/tire combination remounted on the vehicle as soon as possible.

Recommended tire brands

For each tire size, the manufacturer of the vehicle recommends certain tire brands. The tire brands can be identified by a star on the tire sidewall.

New tires

Tire traction is not optimal due to production-related circumstances when tires are brand-new.

Drive conservatively for the first 200 miles/300 km.

Retreaded tires**⚠ Warning**

Retreaded tires can have different tire casing structures. With advanced age the service life can be limited. There is a risk of an accident. The manufacturer of your vehicle does not recommend the use of retreaded tires.

The manufacturer of the vehicle does not recommend the use of retreaded tires.

Winter tires**General information**

Winter tires are recommended for operating on winter roads.

Although so-called all-season tires with M+S identification provide better winter traction than summer tires, they usually do not provide the same level of performance as winter tires.

Maximum speed of winter tires

If the maximum speed of the vehicle is higher than the permissible speed for the winter tires, then attach a label showing the permissible maximum speed in the field of vision. The label is available from a dealer's service center or another qualified service center or repair shop.

With winter tires mounted, observe and do not exceed the permissible maximum speed.

Changing runflat tires

When changing from run-flat tires to standard tires, it must be ensured that the vehicle contains a compact spare tire ("donut") or tire mobility kit. Further information is available from a dealer's service center or another qualified service center or repair shop.

Rotating wheels between axles

Warning

Rotating tires between the axles on vehicles with different tire sizes or rim sizes on the front and rear axles can cause damage to the tires and the vehicle. There is a risk of accident. Do not rotate the tires between the axles on vehicles with different tire sizes or rim sizes on the front and rear axles.

Different wear patterns can occur on the front and rear axles depending on individual driving conditions. The tires can be rotated in pairs between the axles to achieve even wear. Further information is available from a dealer's service center or another qualified service center or repair shop. After rotating, check the tire pressure and correct, if needed.

Storing tires

Tire pressure

Do not exceed the maximum tire inflation pressure indicated on the tire sidewall.

Storage

- ▶ Store wheels and tires in a cool, dry and dark place.
- ▶ Always protect tires against all contact with oil, grease, and solvents.
- ▶ Do not leave tires in plastic bags.
- ▶ Remove dirt from wheels or tires.

Runflat tires

Principle

Run-flat tires permit continued driving under restricted conditions even in the event of a complete tire pressure loss.

General information

The wheels consist of tires that are self-supporting, to a limited degree, and possibly special rims.

The reinforcement of the sidewall allows the tire to remain drivable to a restricted degree in the event of a tire pressure loss.

Follow the instructions for continued driving with a flat tire.

Safety information

Warning

The vehicle handles differently when a run-flat tire has insufficient or no tire pressure; for instance, reduced lane stability when braking, braking distances are longer and the self-steering properties will change. There is a risk of accident. Drive moderately and do not exceed a speed of 50 mph/80 km/h.

Identification



The tires are marked on the tire sidewall with Run-flat System Component RSC.

Repairing a flat tire

Safety measures

- ▶ Park the vehicle as far away as possible from passing traffic and on solid ground.
- ▶ Turn on the hazard warning system.

- ▶ Secure the vehicle against rolling away by setting the parking brake.
- ▶ Turn the steering wheel until the front wheels are in the straight-ahead position and engage the steering wheel lock.
- ▶ Have all vehicle occupants get out of the vehicle and ensure that they remain outside the hazardous area in a safe place, such as behind a guardrail.
- ▶ If necessary, set up a warning triangle at an appropriate distance.

Tire repair set

Principle

With the tire repair set, minor tire damage can be sealed temporarily to enable continued driving.

General information

- ▶ To enable continued driving, liquid sealant is pumped into the tire, which hardens and seals the damage from the inside.
- ▶ Follow the instructions on using the tire repair set found on the compressor and sealant bottle.
- ▶ Use of the tire repair set may be ineffective if the tire puncture measures approx. 4 mm or more.
- ▶ Contact a dealer's service center or another qualified service center or repair shop if the tire cannot be made drivable.
- ▶ Do not remove foreign bodies that have penetrated the tire. Remove foreign objects only when they are visibly protruding from the tire.
- ▶ Pull the speed limit sticker off the sealant bottle and apply it to the steering wheel.
- ▶ The use of a sealing compound can damage the wheel electronics. In this case, have the electronics checked and replaced at the next opportunity.
- ▶ The compressor can be used to check the tire inflation pressure.

Overview

Storage



Storage for the tire repair set is provided in the left storage compartment of the trunk.

Sealant bottle

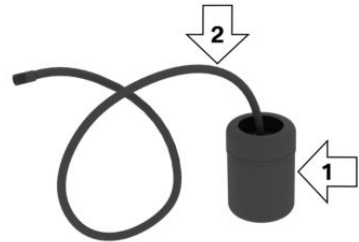

- ▶ Sealant bottle, arrow 1.
- ▶ Filler hose, arrow 2.

Observe expiration date on the sealant bottle.

Compressor

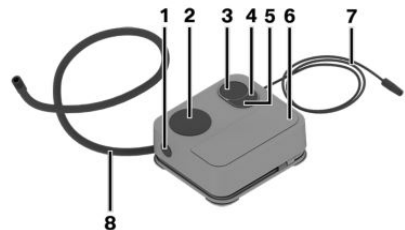

- 1 Sealant bottle locking
- 2 Sealant bottle holder

- 3 Tire pressure display
- 4 Reduce tire inflation pressure button
- 5 On/off switch
- 6 Compressor
- 7 Connector/cable for socket
- 8 Connection hose

Safety measures

- ▷ Park the vehicle as far away as possible from passing traffic and on solid ground.
- ▷ Turn on the hazard warning system.
- ▷ Secure the vehicle against rolling away by setting the parking brake.
- ▷ Turn the steering wheel until the front wheels are in the straight-ahead position and engage the steering wheel lock.
- ▷ Have all vehicle occupants get out of the vehicle and ensure that they remain outside the hazardous area in a safe place, such as behind a guardrail.
- ▷ If necessary, set up a warning triangle at an appropriate distance.

Filling the tire with sealing compound

Safety information

DANGER

If the exhaust pipe is blocked or ventilation is insufficient, harmful exhaust gases can enter into the vehicle. The exhaust gases contain pollutants which are colorless and odorless. In enclosed areas, exhaust gases can also accumulate outside of the vehicle. There is danger to life. Keep the exhaust pipe free and ensure sufficient ventilation.

NOTICE

The compressor can overheat during extended operation. There is a risk of damage to property, among other potential damage. Do not run the compressor for more than 10 minutes.

Filling

1. Shake the sealant bottle.



2. Pull filler hose completely out of the cover of the sealant bottle. Do not kink the hose.

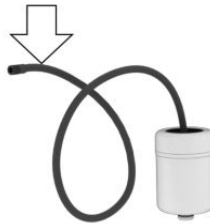

3. Slide the sealant bottle into the holder on the compressor housing, ensuring that it engages audibly.

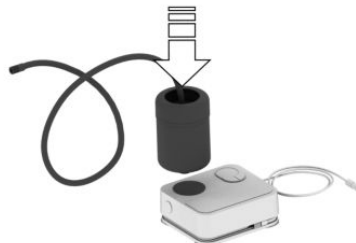

4. Screw the filler hose of the sealant bottle onto the tire valve of the nonworking wheel.



5. With the compressor switched off, insert the connector into the power socket in the vehicle interior.



6. With standby state or drive-ready state switched on, switch on the compressor.

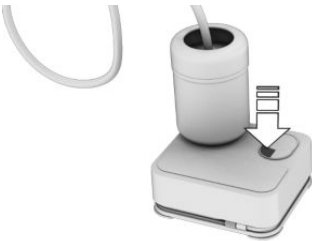

Let the compressor run for max. 10 minutes to fill the tire with sealing compound and achieve a tire inflation pressure of approx. 2.0 bar.

While the tire is being filled with sealing compound, the tire inflation pressure may sporadically reach approx. 5 bar. Do not switch off the compressor in this phase.

Checking and adjusting the tire inflation pressure

Checking

1. Switch off the compressor.
2. Read the tire pressure on the tire pressure display.

To continue the trip, a tire inflation pressure of at least 2 bar must be reached.

Removing and stowing the sealant bottle

1. Unscrew the filler hose of the sealant bottle from the tire valve.
2. Press the red unlocking device.
3. Remove the sealant bottle from the compressor.
4. Wrap and store the sealant bottle in suitable material to avoid contamination of the cargo area.

Minimum tire inflation pressure is not reached

1. Pull the connector out of the power socket in the vehicle interior.
2. Drive 33 ft/10 m forward and back to distribute the sealing compound in the tire.
3. Screw the connection hose of the compressor directly onto the tire valve stem.

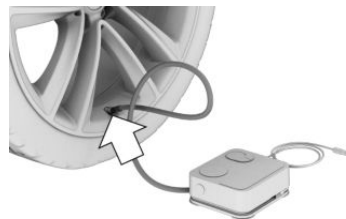

- Insert the connector into the power socket in the vehicle interior.



- With standby or drive readiness turned on, turn on the compressor and let it run for a maximum of 10 minutes.

When the tire pressure does not reach at least 2 bar, contact a manufacturer service center or another qualified service center or repair shop.

When a tire pressure of at least 2 bar is reached, see Minimum tire inflation pressure is reached.

- Unscrew the connection hose of the compressor from the tire valve.
- Pull the connector out of the power socket in the vehicle interior.
- Stow the tire repair set in the vehicle.

Minimum tire inflation pressure is reached

- Unscrew the connection hose of the compressor from the tire valve.
- Pull the connector out of the power socket in the vehicle interior.
- Stow the tire repair set in the vehicle.
- Immediately drive approx. 5 miles/10 km to ensure that the sealing compound is evenly distributed in the tire.

Do not exceed a speed of 50 mph/80 km/h.

If possible, do not drive at speeds less than 12 mph/20 km/h.

Adjustment

- Stop at a suitable location.
- Screw the connection hose of the compressor directly onto the tire valve stem.

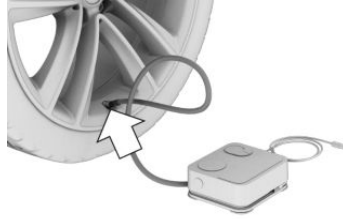

- Insert the connector into the power socket in the vehicle interior.



- Correct the tire inflation pressure to at least 2.0 bar:
 - ▷ Increase tire pressure: with standby or drive readiness turned on, turn on the compressor and let it run for a maximum of 10 minutes.
 - ▷ Reduce tire inflation pressure: press the button on the compressor.
- Unscrew the connection hose of the compressor from the tire valve.
- Pull the connector out of the power socket in the vehicle interior.
- Stow the tire repair set in the vehicle.

Continuing the trip

Do not exceed the permissible maximum speed of 50 mph/80 km/h.

Reinitialize the Flat Tire Monitor.

Reset the Tire Pressure Monitor again.

Replace the faulty tire and the sealant bottle of the tire repair set promptly.

Additional information:

- ▷ Run-flat tires, refer to page 338.
- ▷ Tire pressure monitor, refer to page 331.

Tire chains

Safety information

Warning

With the mounting of tire chains on unsuitable tires, the tire chains can come into contact with vehicle parts. There may be a risk of accident or risk of damage to property. Only mount tire chains on tires that are designated by their manufacturer as suitable for the use of tire chains.

Warning

Insufficiently tight tire chains may damage tires and vehicle components. There may be a risk of accident or risk of damage to property. Make sure that the tire chains are always sufficiently tight. Re-tighten as needed according to the tire chain manufacturer's instructions.

Fine-link tire chains

The manufacturer of the vehicle recommends the use of fine-link tire chains. Certain types of fine-link tire chains have been tested by the manufacturer of the vehicle and recommended as road-safe and suitable.

Information regarding suitable tire chains is available from a dealer's service center or another qualified service center or repair shop.

Use

Use only in pairs on the rear wheels, equipped with the tires of the following size:

- ▷ 225/45 R18.

The wheel size and rim offset are located on the inside of the wheel.

Follow the tire chain manufacturer's instructions.

Do not initialize the Flat Tire Monitor after mounting tire chains, as doing so may result in incorrect readings.

Do not reset the Tire Pressure Monitor after mounting tire chains, as doing so may result in incorrect readings.

When driving with tire chains, briefly activate Dynamic Traction Control DTC to optimize the drive power.

Maximum speed with tire chains

Do not exceed a speed of 30 mph/50 km/h when using tire chains.

Tire pressure monitor

Principle

The Tire Pressure Monitor monitors the tire pressure and issues a warning if the tire pressure has dropped.

General information

Sensors in the tire valves measure the tire inflation pressure and tire temperature.

The system detects the mounted tires automatically. The system displays the predefined nominal pressure values on the Control Display and compares these values to the actual tire pressure values.

If tires are being used that are not specified on the tire inflation pressure details on the vehicle, such as tires with special approval, the system needs to be actively reset. The system will then

take over the actual tire inflation pressures as the target pressures.

When operating the system, also note the information found in the Tire inflation pressure chapter.

Additional information:

Tire inflation pressure, refer to page 316.

Safety information

Warning

The display of the target pressures is not a substitute for the tire inflation pressure details on the vehicle. Incorrect entries in the tire settings can lead to incorrect target tire inflation pressure values. In this case, it cannot be guaranteed that the notification of a tire pressure loss will be reliable. There is a risk of injury and risk of damage to property. Ensure that the tire sizes of the mounted tires are displayed correctly and match the details on the tires and on the vehicle.

Functional requirements

The following conditions must be met for the system; otherwise, reliable message of a tire pressure loss is not assured:

- ▷ After each tire or wheel change, the system detects and updates the mounted tires and displays them after a short trip on the Control Display.
 - Enter the information about the mounted tires in the tire settings when the system does not automatically detect the tires.
- ▷ The Tire Pressure Monitor does not activate until after driving for a few minutes:
 - ▷ After a tire or wheel replacement.
 - ▷ After a reset, for tires with special approval.
 - ▷ After changing the tire setting.
- ▷ For tires with special approval:

- ▷ After a tire or wheel replacement, a reset was performed with the correct tire inflation pressure.
- ▷ After the tire inflation pressure was adjusted to a new value, a reset was performed.
- ▷ Wheels with wheel electronics.

Tire settings

General information

The information about the mounted tires can be entered in the tire settings if the system does not automatically detect the tires.

The tire sizes of the mounted tires can be gathered from the tire inflation pressure details on the vehicle or directly on the tires.

The tire details do not need to be re-entered when the tire pressure is corrected.

For summer and winter tires, the tire details entered last are stored. After a tire or wheel replacement, the settings of the tire sets used last can be selected.

Changing settings

1. "CAR"
2. "Vehicle status"
3.  "Tire Pressure Monitor"
4. "Tire settings"
5. "Tire selection"
6. "Manual"
7. "Tire type"
 - ▷ "Summer"
 - ▷ "Winter/All-year"
8. Select the tire type that is mounted on the rear axle.

For tires with special approval:

"Other tires".

Observe further proceeding in the perform a reset section.

9. Select the maximum road speed that will be used with the tires.

10. "Save tire settings"

The measurement of the current tire inflation pressure is started. The measurement progress is displayed.

Status display

Current status

The system status can be displayed on the Control Display, e.g., whether or not the system is active.

1. "CAR"
2. "Vehicle status"
3. (!) "Tire Pressure Monitor"

The current status is displayed.

Current tire pressure

The current tire pressure is displayed for each tire.

The current tire inflation pressures may change during driving or depending on the outside temperature.

Current tire temperature

Depending on the model, the current tire temperatures are displayed.

The current tire temperatures may change while driving or due to the outside temperature.

Target pressure

The target pressure for the tires on the front and rear axles is displayed.

The specified target pressures take the influence of driving and outside temperature on the tire temperature into account. The appropriate target pressure is always displayed, independent of the weather situation, tire temperatures and travel times.

The displayed target pressure may change and may differ from the tire inflation pressure details

on the door pillar of the driver's door. The tire inflation pressure can thus be corrected to the value of the displayed target pressures.

The target pressure is immediately adjusted if the vehicle load status is changed in the tire settings.

Tire conditions

General information

Tire and system status are indicated by the color of the wheels and a text message on the Control Display.

Any existing messages may not be deleted if the target pressure is not reached after the tire inflation pressure is corrected.

All wheels green

- ▷ The system is active and bases warnings on the target pressures.
- ▷ For tires with special approval: the system is active and bases warnings on the tire inflation pressures stored during the last reset.

One to four yellow wheels

A flat tire or major tire pressure loss has occurred in the indicated tires.

Gray wheels

It may not be possible to identify tire pressure losses.

Possible causes:

- ▷ Malfunction.
- ▷ During tire inflation pressure measurement, after confirmation of the tire settings.
- ▷ For tires with special approval: a reset is performed for the system.

For tires with special approval: perform a reset

1. "CAR"
2. "Vehicle status"

3. "Tire Pressure Monitor"
4. Make sure that correct tire settings have been made.
Tire settings, refer to page 332.
5. Turn on drive-ready state and do not drive off.
6. Reset tire pressure: "Perform reset".
7. Drive away.

The wheels are displayed in gray and the following is displayed "Resetting tire pressure...".

After a travel time of several minutes, the set tire inflation pressures are accepted as the predefined tire inflation pressures. The reset is completed automatically while driving.

After a successfully completed reset, the wheels on the Control Display are shown in green and the following is displayed: "Reset successful."

You may interrupt this trip at any time. When you continue the reset resumes automatically.

Messages: for tires without special approval

General information

A low tire inflation pressure may cause the DSC Dynamic Stability Control to be switched on.

Safety information

Warning

A damaged regular tire with low or missing tire inflation pressure impacts handling, such as steering and braking response. Run-flat tires can maintain limited stability. There is a risk of accident. Do not continue driving if the vehicle is equipped with normal tires. Follow the information on run-flat tires and continued driving with these tires.

If a tire inflation pressure check is required

Message

An icon with a Check Control message appears on the Control Display.

| Icon | Possible cause |
|---|---|
|  | Inflation was not carried out according to specifications, for instance when the tire has not been sufficiently inflated or in the case of a natural steady tire pressure loss. |



Measure

Check the tire pressure and correct as needed.

If the tire inflation pressure is too low

Message



A yellow warning light is illuminated in the instrument cluster.

In addition, an icon with a Check Control message appears on the Control Display.

| Icon | Possible cause |
|---|--------------------------------|
|  | There is a tire pressure loss. |



Measure

1. Reduce the vehicle speed. Do not exceed a speed of 80 mph/130 km/h.
2. At the next opportunity, for instance at a filling station, check the tire inflation pressure in all four tires and correct if necessary.

If there is a significant tire pressure loss

Message



A yellow warning light is illuminated in the instrument cluster.

In addition, an icon with the affected tire appears in a Check Control message on the Control Display.

| Icon | Possible cause |
|--|---|
|  | There is a flat tire or a major tire pressure loss. |



There is a flat tire or a major tire pressure loss.

Measure

1. Reduce your speed and stop cautiously. Avoid sudden braking and steering maneuvers.
2. Check whether the vehicle is fitted with normal tires or run-flat tires.
Run-flat tires are labeled with a circular icon containing the letters RSC marked on the tire sidewall.
Run-flat tires, refer to page [326](#).
3. Read the description on What to do in case of a flat tire.
Actions in the event of a flat tire, refer to page [336](#).

Messages: for tires with special approval

General information

A low tire inflation pressure may cause the DSC Dynamic Stability Control to be switched on.

Safety information

Warning

A damaged regular tire with low or missing tire inflation pressure impacts handling, such as steering and braking response. Run-flat tires can maintain limited stability. There is a risk of accident. Do not continue driving if the vehicle is equipped with normal tires. Follow the information on run-flat tires and continued driving with these tires.

If a tire inflation pressure check is required

Message

An icon with a Check Control message appears on the Control Display.

| Icon | Possible cause |
|---|--|
|  | Inflation was not carried out according to specifications, e.g., the tire has not been sufficiently inflated. The system has detected a wheel change, but no reset was done. The tire inflation pressure has fallen below the level of the last reset. No reset was performed for the system. The system issues a warning based on the tire inflation pressures stored during the last reset. |



Inflation was not carried out according to specifications, e.g., the tire has not been sufficiently inflated.

The system has detected a wheel change, but no reset was done.

The tire inflation pressure has fallen below the level of the last reset.

No reset was performed for the system. The system issues a warning based on the tire inflation pressures stored during the last reset.

Measure

1. Check the tire pressure and correct as needed.
2. Perform a system reset.

If the tire inflation pressure is too low

Message



A yellow warning light is illuminated in the instrument cluster.

In addition, an icon with a Check Control message appears on the Control Display.

| Icon | Possible cause |
|--|--|
|  | There is a tire pressure loss. No reset was performed for the system. The system issues a warning based on the tire inflation pressures stored during the last reset. |



Measure

1. Reduce the vehicle speed. Do not exceed a speed of 80 mph/130 km/h.
2. At the next opportunity, for instance at a filling station, check the tire inflation pressure in all four tires and correct if necessary.
3. Reset the system.

If there is a significant tire pressure loss

Message



A yellow warning light is illuminated in the instrument cluster.

In addition, an icon with the affected tire appears in a Check Control message on the Control Display.

| Icon | Possible cause |
|--|---|
|  | There is a flat tire or a major tire pressure loss. No reset was performed for the system. The system issues a warning based on the tire inflation pressures stored during the last reset. |



Measure

1. Reduce your speed and stop cautiously. Avoid sudden braking and steering maneuvers.
2. Check whether the vehicle is fitted with normal tires or run-flat tires.

Run-flat tires are labeled with a circular icon containing the letters RSC marked on the tire sidewall.

Run-flat tires, refer to page 326.
3. Read the description on What to do in case of a flat tire.

Actions in the event of a flat tire, refer to page 336.

Actions in the event of a flat tire

Normal tires

1. Identify the damaged tire.

Check the tire pressure in all four tires, for instance using the tire pressure display of a flat tire kit.

For tires with special approval: when the tire pressure in all four tires is correct, the Tire Pressure Monitor may not have been reset. In this case, perform the reset.

If tire damage cannot be found, contact a dealer's service center or another qualified service center or repair shop.

2. Repair the flat tire, e.g., with a flat tire kit or by changing the wheel.

Use of sealing compound, for instance from the flat tire kit, may damage the wheel electronics. Have the electronics replaced at the next opportunity.

Runflat tires

Safety information

Warning

The vehicle handles differently when a run-flat tire has insufficient or no tire pressure; for instance, reduced lane stability when braking, braking distances are longer and the self-steering properties will change. There is a risk of accident. Drive moderately and do not exceed a speed of 50 mph/80 km/h.

Maximum speed

You may continue driving with a damaged tire at speeds up to 50 mph/80 km/h.

Continued driving with a flat tire

Follow the following when continuing to drive with a damaged tire:

1. Avoid sudden braking and steering maneuvers.
2. Do not exceed a speed of 50 mph/80 km/h.
3. Check the tire inflation pressure in all four tires at the next opportunity.

Possible driving distance with a depressurized tire

The distance for which it may be possible to drive safely varies depending on how the vehicle is loaded and used, e.g., speed, road conditions, outside temperature. The driving distance may be less but may also be more if an economical driving style is used.

If the vehicle is loaded with an average weight and used under favorable conditions, the distance for which it may be safe to drive may be up to 50 miles/80 km.

Vehicle handling with damaged tires

Vehicles driven with a damaged tire will handle differently, potentially leading to conditions such as the following:

- ▷ Greater likelihood of skidding of the vehicle.
- ▷ Longer braking distances.
- ▷ Changed self-steering properties.

Modify your driving style. Avoid abrupt steering maneuvers or driving over obstacles, for instance curbs or potholes.

Final tire failure

Vibrations or loud noises while driving can indicate the final failure of a tire.

Reduce speed and stop; otherwise, pieces of the tire could come loose and cause an accident.

Do not continue driving. Contact a dealer's service center or another qualified service center or repair shop.

System limits

Temperature

The tire inflation pressure depends on the tire's temperature.

Driving or exposure to the sun will increase the tire's temperature, thus increasing the tire inflation pressure.

The tire inflation pressure is reduced when the tire temperature falls again.

These circumstances may cause a warning when temperatures fall very sharply.

Following a temperature-related warning, the target pressures are displayed on the Control Display again after a short distance.

Sudden tire pressure loss

The system cannot indicate sudden serious tire damage caused by external circumstances.

Failure performing a reset

Tires with special approval: the system will not function correctly if a reset was not performed, for example a flat tire may be indicated although the tire inflation pressures are correct.

Malfunction

Message



The yellow warning light flashes and is then illuminated continuously. A Check Control message is displayed. It may not be possible to identify tire pressure losses.

Measure

- ▶ A wheel without wheel electronics, such as an emergency wheel, is mounted: have the wheels checked, if needed.
- ▶ Fault caused by systems or devices with the same radio frequency: after leaving the area of the interference, the system automatically becomes active again.
- ▶ For tires with special approval: the system was unable to complete the reset. Perform a system reset again.
- ▶ Tire Pressure Monitor malfunction: have the system checked by a manufacturer service center or another qualified service center or repair shop.

Declaration according to NHTSA/ FMVSS 138 Tire Pressure Monitoring System

Each tire, including the spare (if provided) should be checked monthly when cold and inflated to the inflation pressure recommended by the vehicle manufacturer on the vehicle placard or tire inflation pressure label. (If your vehicle has tires of a different size than the size indicated on the vehicle placard or tire inflation pressure label, you should determine the proper tire inflation pressure for those tires.) As an added safety feature, your vehicle has been equipped with a tire pres-

sure monitoring system (TPMS) that illuminates a low tire pressure telltale when one or more of your tires is significantly under-inflated. Accordingly, when the low tire pressure telltale illuminates, you should stop and check your tires as soon as possible, and inflate them to the proper pressure. Driving on a significantly under-inflated tire causes the tire to overheat and can lead to tire failure. Under-inflation also reduces fuel efficiency and tire tread life, and may affect the vehicle's handling and stopping ability. Please note that the TPMS is not a substitute for proper tire maintenance, and it is the driver's responsibility to maintain correct tire pressure, even if under-inflation has not reached the level to trigger illumination of the TPMS low tire pressure telltale. Your vehicle has also been equipped with a TPMS malfunction indicator to indicate when the system is not operating properly. The TPMS malfunction indicator is combined with the low tire pressure telltale. When the system detects a malfunction, the telltale will flash for approximately one minute and then remain continuously illuminated. This sequence will continue upon subsequent vehicle start-ups as long as the malfunction exists. When the malfunction indicator is illuminated, the system may not be able to detect or signal low tire pressure as intended. TPMS malfunctions may occur for a variety of reasons, including the installation of replacement or alternate tires or wheels on the vehicle that prevent the TPMS from functioning properly. Always check the TPMS malfunction telltale after replacing one or more tires or wheels on your vehicle to ensure that the replacement or alternate tires and wheels allow the TPMS to continue to function properly.

Flat Tire Monitor FTM

Principle

The Flat Tire display detects a tire pressure loss while driving and issues a warning if the tire pressure has dropped.

General information

The system detects tire pressure loss on the basis of rotation speed differences between the individual wheels while driving.

In the event of a tire pressure loss, the diameter and therefore the rotational speed of the corresponding wheel changes. The difference will be detected and reported as a flat tire.

The system does not measure the actual inflation pressure in the tires.

Functional requirements

The following conditions must be met for the system; otherwise, reliable message of a tire pressure loss is not assured:

- ▷ After a tire or wheel replacement, an initialization was performed with the correct tire inflation pressure.
- ▷ After the tire pressure was adjusted to a new value, an initialization was performed.

Status display

The current status of the Flat Tire Monitor FTM can be displayed, for instance whether the FTM is active.

1. "CAR"
2. "Vehicle status"
3.  "Flat Tire Monitor"

The status is displayed.

Initialization required

An initialization must be performed in the following situations:

- ▷ After the tire inflation pressure has been adjusted.
- ▷ After a tire or wheel replacement.

Performing initialization

When initializing, the set tire inflation pressures serve as reference values in order to detect a flat

tire. Initialization is started by confirming the tire inflation pressures.

Do not initialize the system when driving with tire chains.

1. "CAR"
2. "Vehicle status"
3. "Flat Tire Monitor"
4. Turn on drive-ready state and do not drive off.
5. Start the initialization with: "Perform reset"
6. Drive away.

The initialization is completed while driving, which can be interrupted at any time.

The initialization automatically continues when driving continues.

Messages

General information

When a flat tire is indicated, DSC Dynamic Stability Control is switched on, if needed.

Safety information

Warning

A damaged regular tire with low or missing tire inflation pressure impacts handling, such as steering and braking response. Run-flat tires can maintain limited stability. There is a risk of accident. Do not continue driving if the vehicle is equipped with normal tires. Follow the information on run-flat tires and continued driving with these tires.

Indication of a flat tire



A yellow warning light is illuminated in the instrument cluster.

In addition, an icon with a Check Control message appears on the Control Display.

Icon Possible cause

There is a flat tire or a major tire pressure loss.

Measure

1. Reduce your speed and stop cautiously. Avoid sudden braking and steering maneuvers.
2. Check whether the vehicle is fitted with normal tires or run-flat tires.
Run-flat tires are labeled with a circular icon containing the letters RSC marked on the tire sidewall.
Run-flat tires, refer to page [326](#).

Actions in the event of a flat tire**Normal tires**

1. Identify the damaged tire.
To do this, check the tire pressure in all four tires, for instance using the tire pressure display of a flat tire kit.
When the tire inflation pressure in all four tires is correct, the Flat Tire Monitor FTM may not have been initialized. In this case, initialize the system.
If identification of flat tire damage is not possible, please contact a dealer's service center or another qualified service center or repair shop.
2. Repair the flat tire, e.g., with a flat tire kit or by changing the wheel.

Runflat tires**Safety information****⚠ Warning**

The vehicle handles differently when a run-flat tire has insufficient or no tire pressure; for instance, reduced lane stability when braking, braking distances are longer and the self-steering properties will change. There is a risk of accident. Drive moderately and do not exceed a speed of 50 mph/80 km/h.

Maximum speed

You may continue driving with a damaged tire at speeds up to 50 mph/80 km/h.

Continued driving with a flat tire

Follow the following when continuing to drive with a damaged tire:

1. Avoid sudden braking and steering maneuvers.
2. Do not exceed a speed of 50 mph/80 km/h.
3. Check the tire inflation pressure in all four tires at the next opportunity.

When the tire inflation pressure in all four tires is correct, the Flat Tire Monitor may not have been initialized. In this case, initialize the system.

Possible driving distance with a depressurized tire

The distance for which it may be possible to drive safely varies depending on how the vehicle is loaded and used, e.g., speed, road conditions, outside temperature. The driving distance may be less but may also be more if an economical driving style is used.

If the vehicle is loaded with an average weight and used under favorable conditions, the distance for which it may be safe to drive may be up to 50 miles/80 km.

Vehicle handling with damaged tires

Vehicles driven with a damaged tire will handle differently, potentially leading to conditions such as the following:

- ▶ Greater likelihood of skidding of the vehicle.
- ▶ Longer braking distances.
- ▶ Changed self-steering properties.

Modify your driving style. Avoid abrupt steering maneuvers or driving over obstacles, for instance curbs or potholes.

Final tire failure

Vibrations or loud noises while driving can indicate the final failure of a tire.

Reduce speed and stop; otherwise, pieces of the tire could come loose and cause an accident.

Do not continue driving. Contact a dealer's service center or another qualified service center or repair shop.

System limits

The system could be delayed or malfunction in the following situations:

- ▶ A natural, even tire pressure loss in all four tires will not be recognized. Therefore, check the tire inflation pressure regularly.
- ▶ Sudden serious tire damage caused by external circumstances cannot be recognized in advance.
- ▶ The system has not been initialized.
- ▶ When driving on a snowy or slippery road.
- ▶ Sporty driving style: slip on traction wheels, high lateral acceleration (drifting).
- ▶ When driving with tire chains.

Changing wheels/tires

General information

When using run-flat tires or a flat tire kit, a wheel does not always need to be changed immedi-

ately when there is a tire pressure loss due to a flat tire.

If needed, the tools for changing wheels are available as accessories from a dealer's service center or another qualified service center or repair shop.

Safety information

Warning

The vehicle jack is only provided for short-term lifting of the vehicle for wheel changes. Even if all safety measures are observed, there is a risk of the raised vehicle falling, if the vehicle jack tips over. There is a risk of injury or danger to life. When the vehicle is raised with the vehicle jack, do not lie under the vehicle and do not switch on the drive-ready state.

Warning

Supports such as wooden blocks under the vehicle jack reduce the capacity of the vehicle jack to bear weight. They have the potential to exert too much strain on the vehicle jack, causing it to tip over and the vehicle to fall. There is a risk of injury or danger to life. Do not place supports under the vehicle jack.

Warning

The jack, issued by the vehicle manufacturer, is provided in order to perform a wheel change in the event of a breakdown. The jack is not designed for frequent use; for example, changing from summer to winter tires. Using the jack frequently may cause it to become jammed or damaged. There is a risk of injury and risk of damage to property. Only use the jack to attach an emergency or spare wheel in the event of a breakdown.

Warning

On soft, uneven or slippery ground, for example snow, ice, tiles, etc., the vehicle jack can slip away. There is a risk of injury. If possible, change the wheel on a flat, solid, and slip-resistant surface.

Warning

The vehicle jack is optimized for lifting the vehicle and for the jacking points on the vehicle only. There is a risk of injury. Do not lift any other vehicle or cargo using the vehicle jack.

Warning

When the vehicle jack is not inserted into the jacking point provided for this purpose, the vehicle may be damaged or the vehicle jack may slip when it is being cranked up. There is a risk of injury or risk of damage to property. When cranking up the vehicle jack, ensure that it is inserted in the jacking point next to the wheel housing.

Warning

A vehicle that is raised on a vehicle jack may fall off of the jack if lateral forces are exerted on it. There is a risk of injury and risk of damage to property. While the vehicle is raised, do not exert lateral forces on the vehicle or pull abruptly on the vehicle. Have a stuck wheel removed by a dealer's service center or another qualified service center or repair shop.

Securing the vehicle against rolling**General information**

The vehicle manufacturer recommends to additionally secure the vehicle against rolling away when changing a wheel.

On a level surface

Place wheel chocks or other suitable objects in front and behind the wheel that is diagonal to the wheel to be changed.

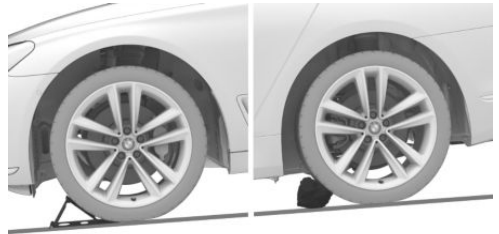
On a slight downhill gradient

If you need to change a wheel on a slight downhill grade, place chocks and other suitable objects, for instance rocks, under the wheels of both the front and rear axles against the rolling direction.

Lug bolt lock

Principle

The wheel lug bolts have a special coding. The lug bolts can only be released with the adapter which matches the coding.

Overview

The adapter of the lug bolt lock is in the onboard vehicle tool kit or in a storage compartment close to the onboard vehicle tool kit.

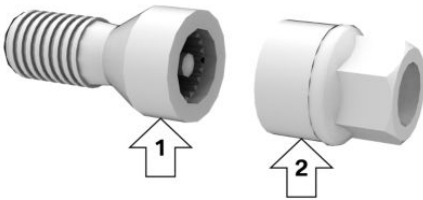

- ▷ Lug lock bolt, arrow 1.
- ▷ Adapter, arrow 2.

Unscrewing

1. Attach the adapter to the lug lock bolt.
2. Unscrew the lug lock bolt.
3. Remove the adapter after unscrewing the lug bolt.

Screwing on

1. Attach the adapter to the lug lock bolt. If necessary, turn the adapter until it fits on the lug lock bolt.
2. Screw on the lug lock bolt. The tightening torque is 101 lbs ft/140 Nm.
3. Remove the adapter and stow it after screwing on the lug bolt.

Preparing the vehicle

- ▷ Park the vehicle on solid and non-slip ground at a safe distance from traffic.
- ▷ Turn on the hazard warning system.
- ▷ Set the parking brake.
- ▷ Engage a gear or move the selector lever to position P.
- ▷ As soon as permitted by the traffic flow, have all vehicle occupants get out of the vehicle and ensure that they remain outside the hazardous area in a safe place, such as behind a guardrail.
- ▷ Depending on the vehicle equipment, get wheel change tools and, if necessary, the emergency wheel from the vehicle.
- ▷ If necessary, set up a warning triangle or portable hazard warning light at an appropriate distance.
- ▷ Secure the vehicle additionally against rolling.
- ▷ Loosen the lug bolts a half turn.

Jacking points for the vehicle jack

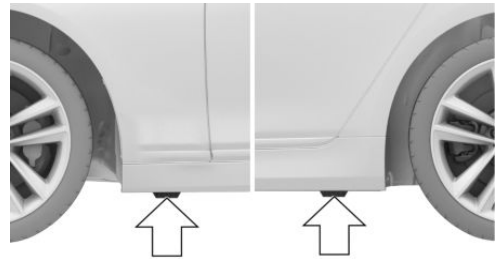

The jacking points for the vehicle jack are located at the indicated positions.

Jacking up the vehicle

Warning

Hands and fingers can be jammed when using the vehicle jack. There is a risk of injury. Comply with the described hand position and do not change this position while using the vehicle jack.

1. Hold the vehicle jack with one hand, arrow 1, and grasp the vehicle jack crank or lever with your other hand, arrow 2.

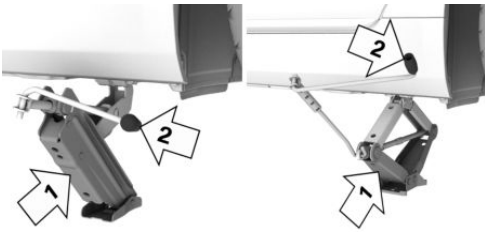

2. Insert the vehicle jack into the rectangular recess of the jacking point closest to the wheel to be changed.

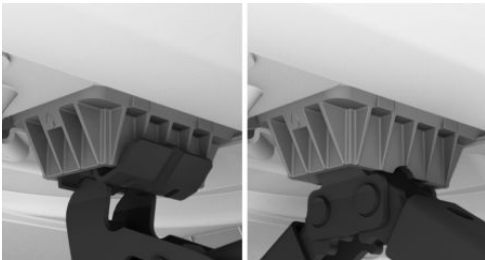

3. Extend the vehicle jack by turning the vehicle jack crank or lever clockwise.



4. Take your hand away from the vehicle jack as soon as the vehicle jack is under load and continue turning the vehicle jack crank or lever with one hand.
5. Make sure that the vehicle jack foot stands vertically and at a right angle beneath the jacking point.

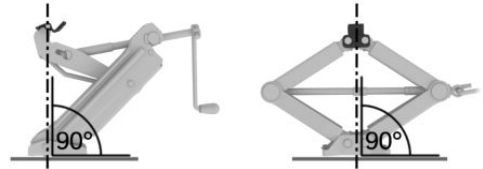

6. Make sure that the vehicle jack foot stands vertically and perpendicularly beneath the jacking point after extending the vehicle jack.

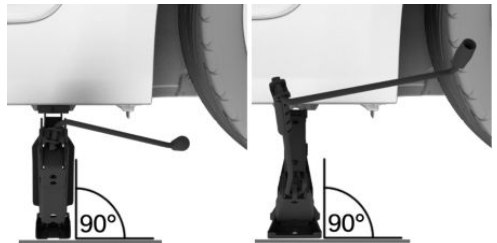

7. Crank the vehicle up, until the vehicle jack is with the entire surface on the ground and the relevant wheel is maximum 1.2 inches/3 cm above ground.

Mounting a wheel

Mount one emergency wheel only, as required.

1. Unscrew the lug bolts.
2. Remove the wheel.
3. Put the new wheel or emergency wheel on and screw in at least two lug bolts in a cross-wise pattern until hand-tight.

When non-original light-alloy wheels of the vehicle manufacturer are mounted, the accompanying lug bolts may have to be used as well.

4. Hand-tighten the remaining lug bolts and tighten all lug bolts well in a crosswise pattern.
5. Turn the vehicle jack crank counterclockwise to retract the vehicle jack and lower the vehicle.
6. Remove the vehicle jack and stow it securely.

After the wheel change

1. Tighten the lug bolts crosswise. The tightening torque is 101 lbs ft/140 Nm.
2. Stow the nonworking wheel in the cargo area, if necessary.
3. Check tire inflation pressure at the next opportunity and correct as needed.
4. Reinitialize the Flat Tire Monitor.
Reset the Tire Pressure Monitor again.
5. Check to make sure the lug bolts are tight with a calibrated torque wrench.
6. Have the damaged tire replaced at the nearest dealer's service center or another qualified service center or repair shop.

Emergency wheel

Principle

In the event of a flat tire, the emergency wheel can be used in place of the wheel with the defective tire. The emergency wheel is only intended

for temporary use until the defective tire/wheel has been replaced.

General information

Mount one emergency wheel only.

Also check the tire inflation pressure of the emergency wheel in the cargo area regularly, and correct it as needed.

Safety information

Warning

The emergency wheel has particular dimensions. When driving with an emergency wheel, changed driving properties may occur, for instance reduced lane stability when braking, longer braking distance, and changed self-steering properties in the limit area. There is a risk of accident. Drive moderately and do not exceed a speed of 50 mph/80 km/h.

Overview

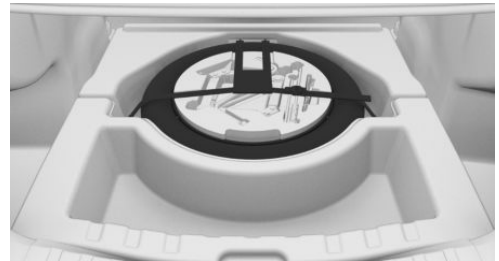

The emergency wheel and the wheel change tools are located in the cargo area under the cargo floor panel.

Removing the emergency wheel

1. Pull the luggage compartment floor up.
2. Slacken the luggage strap at the clasp, arrow 1, but do not release completely.

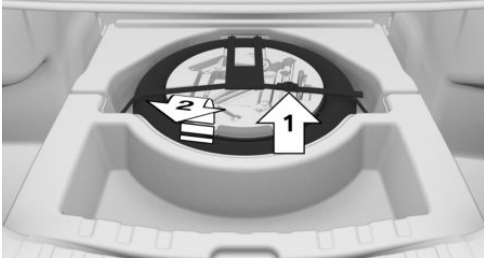

3. Detach the hooks of the luggage straps at the lashing points.
4. Remove the tool holder from the emergency wheel.
5. Remove the emergency wheel from the storage well, arrow 2.

Inserting the emergency wheel

1. Pull the luggage compartment floor up.
2. Place the emergency wheel in the storage well.
3. Insert the tool holder.
4. Attach the hooks of the luggage straps at the lashing points.
5. Tie the ratchet strap. Make sure that it is correctly and firmly seated.
6. Push the cargo floor panel downward.

Engine compartment

Vehicle features and options

This chapter describes all standard, country-specific and optional features offered with the series. It also describes features and functions that are

not necessarily available in your vehicle, e.g., due to the selected options or country versions. This also applies to safety-related functions and systems. When using these functions and systems, the applicable laws and regulations must be observed.

Overview

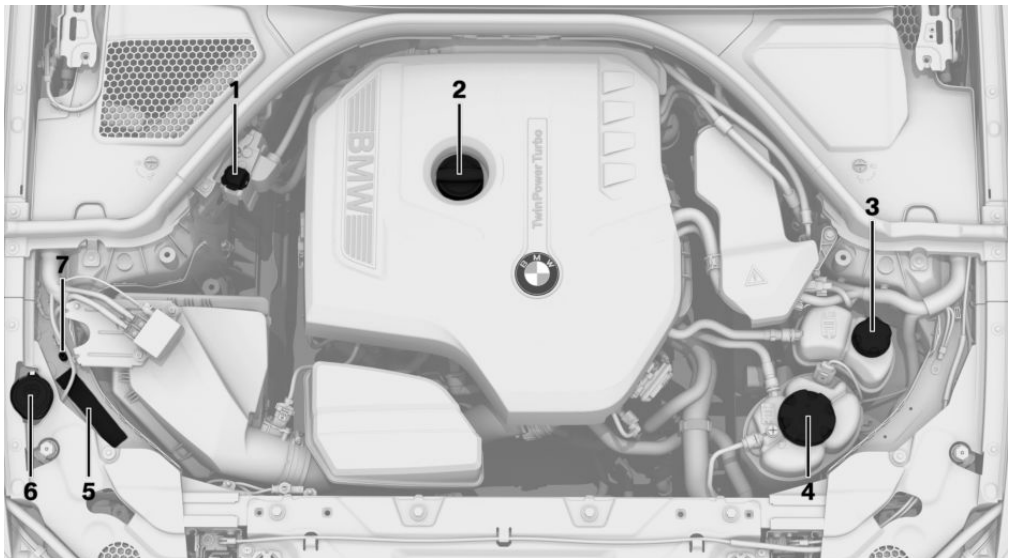

- | | |
|--|--|
| 1 Jump-starting, positive battery terminal | 4 Coolant reservoir, engine |
| 2 Oil filler neck | 5 Vehicle identification number |
| 3 Depending on motorization: coolant reservoir for additional radiator | 6 Filler neck for washer fluid |
| | 7 Jump-starting, negative battery terminal |

Hood

Safety information

Warning

Improperly executed work in the engine compartment can damage vehicle components and impair vehicle functions. There is a risk of an accident and damage to property. Have work in the engine compartment performed by a dealer's service center or another qualified service center or repair shop.

Warning

The engine compartment accommodates moving components. Certain components in the engine compartment can also move with the vehicle switched off, for instance the radiator fan. There is a risk of injury. Do not reach into the area of moving parts. Keep articles of clothing and hair away from moving parts.

Warning

There are protruding parts, for instance locking hook, on the inside of the hood. There is a risk of injury. If the hood is open, pay attention to protruding parts and keep clear of these areas.

Warning

An incorrectly locked hood can open while driving and restrict visibility. There is a risk of accident. Stop immediately and correctly close the hood.

Warning

Body parts can be jammed when opening and closing the hood. There is a risk of injury. Make sure that the area of movement of hood is clear during opening and closing.

NOTICE

Folded-away wipers can be jammed when the hood is opened. There is a risk of damage to property, among other potential damage. Make sure that the wipers with the wiper blades mounted are folded down onto the windshield before opening the hood.

NOTICE

When the hood is closed, it must engage on both sides. Pressing again can damage the hood. There is a risk of damage to property, among other potential damage. Open the hood again and then close it energetically. Avoid pressing again.

Opening hood

1. Pull lever, arrow 1.

Hood is unlocked.



2. After the lever is released, pull the lever again, arrow 2.
Hood can be opened.
3. Be careful of protruding parts on the hood.

Closing the hood

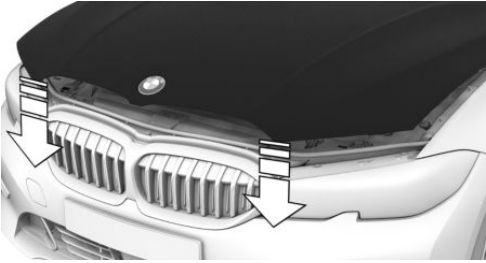

Energetically close the hood from approx.
20 in/50 cm.

The hood must engage on both sides.

Operating materials

Vehicle features and options

This chapter describes all standard, country-specific and optional features offered with the series. It also describes features and functions that are not necessarily available in your vehicle, e.g., due to the selected options or country versions. This also applies to safety-related functions and systems. When using these functions and systems, the applicable laws and regulations must be observed.

Fuel recommendation

General information

Depending on the region, many filling stations sell fuel that has been customized to winter or summer conditions. Fuel that is available in winter, for instance helps make a cold start easier.

Gasoline

General information

For the best fuel efficiency, the gasoline should be sulfur-free or very low in sulfur content.

Fuels that are marked on the gas pump as containing metal must not be used.

Fuels with a maximum ethanol content of 25 %, i. e. E10 or E25, may be used for refueling.

Ethanol should meet the following quality standards:

US: ASTM 4806–xx

CAN: CGSB-3.511–xx

xx: comply with the current standard in each case.

Safety information

CAUTION

The use of poor-quality fuels may result in harmful engine deposits or damage. Additionally, problems relating to drivability, starting and stalling, especially under certain environmental conditions such as high ambient temperature and high altitude, may occur.

If drivability problems are encountered, we recommend switching to a high quality gasoline brand and a higher octane grade — AKI number — for a few tank fills. To avoid harmful engine deposits, it is highly recommended to purchase gasoline from Top Tier retailers.

Failure to comply with these recommendations may result in the need for additional maintenance.

NOTICE

Even small quantities of the wrong fuel or wrong fuel additives can damage the fuel system and engine. Furthermore, the catalytic converter is permanently damaged. There is a risk of damage to property, among other potential damage. Do not refuel or add the following in the case of gasoline engines:

- ▷ Leaded gasoline.
- ▷ Metallic additives, for instance manganese or iron.

Do not press the Start/Stop button after refueling with the wrong fuel. Contact a dealer's service center or another qualified service center or repair shop.

⚠ NOTICE

Fuel that does not comply with the minimum quality can compromise engine function or cause engine damage. There is a risk of damage to property, among other potential damage. Do not fill with fuel that does not comply with the minimum quality.

⚠ NOTICE

Incorrect fuels can damage the fuel system and the engine. There is a risk of damage to property, among other potential damage. Do not use fuels with a higher ethanol content than recommended. Do not refuel with fuels containing methanol, e.g. M5 to M100.

Recommended gas quality

BMW recommends AKI 91.

M Performance model:

BMW recommends AKI 93.

Refuel with this gasoline to achieve the rated performance and consumption values.

Minimum fuel grade

BMW recommends AKI 89.

If you use gasoline with this minimum AKI Rating, the engine may produce knocking sounds when starting at high external temperatures. This has no effect on the engine life.

BMW recommends
Shell Quality Fuels 

Engine oil

General information

The engine oil consumption is dependent on your driving style and driving conditions.

Therefore, regularly check the engine oil level after refueling by taking a detailed measurement.

The engine oil consumption can increase in the following situations, for instance:

- ▷ Sporty driving style.
- ▷ Break-in of the engine.
- ▷ Idle operation of the engine.
- ▷ With use of engine oil types that are classified as not suitable.

Different Check Control messages appear on the Control Display depending on the engine oil level.

Safety information

⚠ NOTICE

An engine oil level that is too low causes engine damage. There is a risk of damage to property, among other potential damage. Immediately add engine oil.

⚠ NOTICE

Too much engine oil can damage the engine or the catalytic converter. There is a risk of damage to property, among other potential damage. Do not add too much engine oil. When too much engine oil is added, have the engine oil level corrected by a dealer's service center or another qualified service center or repair shop.

Electronic oil measurement

General information

The electronic oil measurement has two measuring principles:

- ▷ Monitoring.
- ▷ Detailed measurement.

When making frequent short-distance trips or using a sporty driving style, for instance when taking curves aggressively, regularly perform a detailed measurement.

Monitoring

Principle

The engine oil level is monitored electronically while driving and can be shown on the Control Display.

If the engine oil level is outside its permissible operating range, a Check Control message is displayed.



A red indicator light indicates that the engine oil pressure is too low.

Functional requirements

A current measured value is available after approx. 30 minutes of normal driving.

Displaying the engine oil level

1. "CAR"
2. "Vehicle status"
3.  "Engine oil level"

The engine oil level is displayed.

System limits

When making frequent short-distance trips or using a sporty driving style, it may not be possible to calculate a measured value. In this case, the measured value for the last, sufficiently long trip is displayed.

Detailed measurement

Principle

The engine oil level is checked when the vehicle is stationary and displayed via a scale.

If the engine oil level is outside its permissible operating range, a Check Control message is displayed.

General information

During the measurement, the idle speed is increased somewhat.

Functional requirements

- ▷ Vehicle is parked in a horizontal position.
- ▷ Steptronic transmission: selector lever in selector lever position N or P and accelerator pedal not depressed.
- ▷ The drive-ready state is switched on by pressing the Start/Stop button.
- ▷ Engine is running and is at operating temperature.

Performing a detailed measurement

1. "CAR"
2. "Vehicle status"
3.  "Engine oil level"
4. "Engine oil measurement"
5. "Start measurement"

The engine oil level is checked and displayed via a scale.

Adding engine oil

General information

Only add engine oil when the message is displayed in the instrument cluster. The quantity to be added is indicated in the message shown on the Control Display.

Only add suitable types of engine oil.

Safely park the vehicle and switch off drive-ready state before adding engine oil.

Take care not to add too much engine oil.

Safety information

Warning

Operating materials, for instance oils, greases, coolants, fuels, can contain harmful ingredients. There is a risk of injury or danger to life. Follow the instructions on the containers. Avoid the contact of articles of clothing, skin or eyes with operating materials. Do not refill operating materials into different bottles. Store operating materials out of reach of children.

NOTICE

An engine oil level that is too low causes engine damage. There is a risk of damage to property, among other potential damage. Immediately add engine oil.

NOTICE

Too much engine oil can damage the engine or the catalytic converter. There is a risk of damage to property, among other potential damage. Do not add too much engine oil. When too much engine oil is added, have the engine oil level corrected by a dealer's service center or another qualified service center or repair shop.

Overview

The oil filler neck is located in the engine compartment.

Additional information:

For an overview, refer to page [347](#).

Adding engine oil

1. Opening the hood.

Opening, refer to page [348](#).

2. Open the lid counterclockwise.



3. Add engine oil.

4. Close the lid.

Engine oil types to add

General information

The engine oil grade is critical for the life of the engine.

Only add with the types of engine oil which are listed.

Safety information

NOTICE

Oil additives can damage the engine. There is a risk of damage to property, among other potential damage. Do not use oil additives.

NOTICE

Incorrect engine oil can cause malfunctions in the engine or damage it. There is a risk of damage to property, among other potential damage. When selecting an engine oil, make sure that the engine oil has the correct oil specification.

Suitable engine oil types

Add engine oils that meet the following oil rating standards:

Gasoline engine

BMW Longlife-01 FE.

BMW Longlife-14 FE+.

BMW Longlife-17 FE+.

Alternative engine oil types

If an engine oil suitable for continuous use is not available, up to 1 US quart/liter of an engine oil with the following oil rating can be added:

Oil specification

API SL.

API SM.

API SN.

Viscosity grades

When selecting an engine oil, make sure that the engine oil has a suitable viscosity grade. The suitable viscosity grade is indicated on a label in the engine compartment.

Viscosity grades

SAE 0W-20.

SAE 0W-30.

More information about suitable oil specifications and viscosity grades of engine oils can be requested from a dealer's service center or another qualified service center or repair shop.

Engine oil change**⚠ NOTICE**

Engine oil that is not changed in timely fashion can cause increased engine wear and thus engine damage. There is a risk of damage to property. It is recommended that you do not exceed the service intervals indicated in the vehicle.

The vehicle manufacturer recommends that you have a dealer's service center or another qualified service center or repair shop change the engine oil.

**BMW recommends
Original BMW Engine Oil.**

Coolant**General information**

Coolant consists of water and coolant additive.

Not all commercially available additives are suitable for the vehicle. Do not mix additives of different colors. Observe the water - additive mixture ratio of 50:50. Information about suitable additives is available from a dealer's service center or another qualified service center or repair shop.

Safety information**⚠ Warning**

With the engine hot and the cooling system open, coolant can escape and lead to scalding. There is a risk of injury. Only open the cooling system with the engine cooled down.

⚠ Warning

Additives are harmful and incorrect additives can damage the engine. There is a risk of injury and risk of damage to property. Do not allow additives to come into contact with skin, eyes or articles of clothing. Use suitable additives only.

Coolant level

General information

Depending on the motorization, there are up to two coolant reservoirs in the engine compartment. Check and add the coolant levels on a regular basis.

The coolant level is indicated using the Max mark in the filler neck of the coolant reservoir.

Additional information:

For an overview, refer to page 347.

Checking the coolant level

1. Let the engine cool down.
2. Opening the hood.
Opening, refer to page 348.
3. Turn the lid of the coolant reservoir slightly counterclockwise to allow any excess pressure to dissipate, then open it.
4. Open the coolant reservoir lid.
5. The coolant level is correct when it is just below the maximum mark in the filler neck.

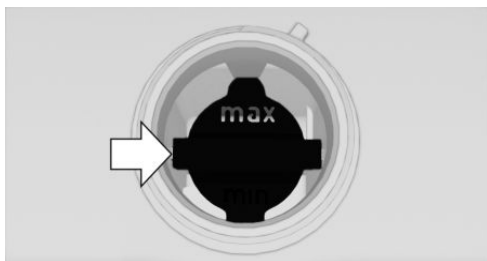

6. Close the lid.

Adding coolant

1. Let the engine cool down.
2. Opening the hood.
Opening, refer to page 348.
3. Turn the lid of the coolant reservoir slightly counterclockwise to allow any excess pressure to dissipate, then open it.
4. Open the coolant reservoir lid.

5. If the coolant is low, slowly add coolant up to the specified level; do not overfill.
6. Close the lid.
7. Have the cause of the coolant loss eliminated as soon as possible.

Disposal



Comply with the relevant environmental protection regulations when disposing of coolant and coolant additives.

Washer fluid

General information

All windshield washer jets are supplied from one tank.

Use a mixture of tap water and windshield washer concentrate. If desired, a windshield washer concentrate containing antifreeze can be used.

Recommended minimum fill quantity:
0.2 US gal/1 liter.

Safety information

Warning

Some types of antifreeze can contain harmful substances and are flammable. There is a risk of fire and an injury hazard. Follow the instructions on the containers. Keep antifreeze away from ignition sources. Do not refill operating materials into different bottles. Store operating materials out of reach of children.

United States: the washer fluid mixture ratio is regulated by the U.S. EPA and many individual states; do not exceed the allowable washer fluid dilution ratio limits that apply. Follow the usage instructions on the washer fluid container.

Use of BMW's Windshield Washer Concentrate or the equivalent is recommended.

Warning

Washer fluid can ignite and catch fire on contact with hot engine parts. There is a risk of injury or risk of damage to property. Only add washer fluid when the engine is cooled down. Next, fully close the lid of the washer fluid reservoir.

NOTICE

Silicon-containing additives in the washer fluid for the water-repelling effect on the windows can lead to damage to the washing system. There is a risk of damage to property, among other potential damage. Do not add silicon-containing additives to the washer fluid.

NOTICE

Mixing different windshield washer concentrates or antifreeze can damage the washing system. There is a risk of damage to property, among other potential damage. Do not mix different windshield washer concentrates or antifreeze. Follow the information and mixture ratios provided on the containers.

Malfunction

The use of undiluted windshield washer concentrate or alcohol-based antifreeze can lead to incorrect readings at temperatures below +5 °F/-15 °C.

Overview

The washer fluid reservoir is located in the engine compartment.

Maintenance

Vehicle features and options

This chapter describes all standard, country-specific and optional features offered with the series. It also describes features and functions that are not necessarily available in your vehicle, e.g., due to the selected options or country versions. This also applies to safety-related functions and systems. When using these functions and systems, the applicable laws and regulations must be observed.

BMW maintenance system

The maintenance system provides service notifications and thereby provides support in maintaining road safety and the operational reliability of the vehicle.

In some cases, scopes and intervals of the maintenance system may vary according to the country version. Replacement work, spare parts, fuels and lubricants, and wear materials are calculated separately. Further information is available from a dealer's service center or another qualified service center or repair shop.

Condition Based Service CBS

Principle

Sensors and special algorithms take into account the driving conditions of the vehicle. CBS uses these to provide maintenance recommendations.

The system makes it possible to adapt the amount of maintenance corresponding to your user profile.

General information

Information on service notifications can be displayed on the Control Display.

Additional information:

Service notifications, refer to page [163](#).

Service data in the vehicle key

Information on the service notifications is continuously stored in the vehicle key. The service center can read this data out and suggest a maintenance scope for the vehicle.

Therefore, hand the service advisor the vehicle key with which the vehicle was driven most recently.

Storage periods

Storage periods during which the vehicle battery was disconnected are not taken into account.

If this occurs, have a dealer's service center or another qualified service center or repair shop update the time-dependent maintenance procedures, such as checking brake fluid and, if necessary, changing the engine oil and the microfilter/activated-charcoal filter.

Maintenance Booklet for US Models

Please consult your Maintenance Booklet for additional information on the performance of service and maintenance work.

The manufacturer of your vehicle recommends that maintenance and repair be performed by a service center or another qualified service center or repair shop. Records of regular maintenance and repair work should be retained.

Socket for OBD Onboard Diagnosis

General information

Devices connected to the OBD socket trigger the alarm system when the vehicle is locked. Remove any devices connected at the OBD socket before locking the vehicle.

Safety information

NOTICE

The socket for Onboard Diagnosis is an intricate component intended to be used in conjunction with specialized equipment to check the vehicle's primary emissions system. Improper use of the socket for Onboard Diagnosis, or contact with the socket for Onboard Diagnosis for other than its intended purpose, can cause vehicle malfunctions and creates risks of personal and property damage. Given the foregoing, the manufacture of your vehicle strongly recommends that access to the socket for Onboard Diagnosis be limited to a dealer's service center or another qualified service center or repair shop or other persons that have the specialized training and equipment for purposes of properly utilizing the socket for Onboard Diagnosis.

Position

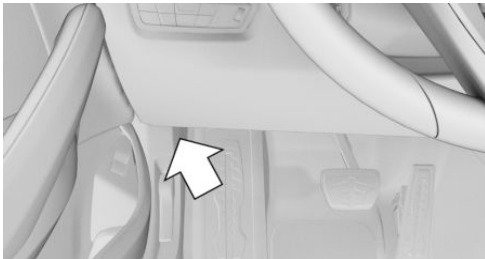

Located on the driver's side is an OBD socket for reading the vehicle data.

Emissions



- ▶ The warning light lights up: Emissions are deteriorating. Have the vehicle checked as soon as possible.
- ▶ The warning light flashes under certain circumstances:

This indicates that there is excessive misfiring in the engine.

Reduce the vehicle speed and have the system checked immediately; otherwise, serious engine misfiring within a brief period can seriously damage emission control components, in particular the catalytic converter.

Replacing components

Vehicle features and options

This chapter describes all standard, country-specific and optional features offered with the series. It also describes features and functions that are not necessarily available in your vehicle, e.g., due to the selected options or country versions. This also applies to safety-related functions and systems. When using these functions and systems, the applicable laws and regulations must be observed.

Vehicle tool kit



The onboard vehicle tool kit is located in the left storage compartment of the cargo area under a cover.

Wiper blades

Safety information

NOTICE

The window may sustain damage if the wiper falls onto it without the wiper blade installed. There is a risk of damage to property, among other potential damage. Hold the wiper firmly when changing the wiper blade. Do not fold or

switch on the wiper without a wiper blade installed.

NOTICE

Folded-away wipers can be jammed when the hood is opened. There is a risk of damage to property, among other potential damage. Make sure that the wipers with the wiper blades mounted are folded down onto the windshield before opening the hood.

Replacing the wiper blades

1. To change the wiper blades, fold up the wiper arms.
Fold-away position of the wipers, refer to page 141.
2. Fold up and hold the wiper arm firmly.
3. Squeeze the retainer spring, arrow 1, and fold up the wiper blade, arrow 2.

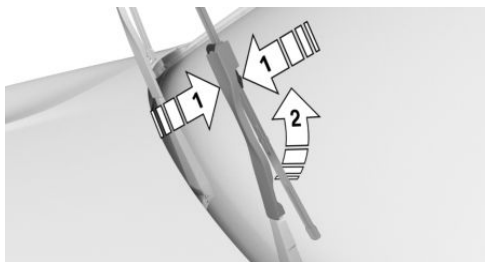

4. Remove the wiper blade forward from the catch.
5. Insert the new wiper blade in reverse order of removal until it locks in place.
6. Fold down the wipers.

Lights and bulbs

General information

Lights and bulbs make an essential contribution to driving safety.

All headlights and lights are made using LED or laser technology.

Some items of equipment use light-emitting diodes installed behind a cover as a light source. These light-emitting diodes are related to conventional lasers and are officially designated as Class 1 light-emitting diodes.

The manufacturer of the vehicle recommends that you let a dealer's service center or another qualified service center or repair shop perform the work in case of a malfunction.

Safety information

Warning

Focused laser light can irritate or permanently damage the retina of the eye. There is a risk of injury. The manufacturer of the vehicle recommends that the work on the lighting system including bulb replacement be performed by a dealer's service center or another qualified service center or repair shop.

Warning

Intensive brightness can irritate or damage the retina of the eye. There is a risk of injury. Do not look directly into the headlights or other light sources. Do not remove the LED covers.

Headlight glass

The inside of the headlight glass can fog up in cool or humid weather. When driving with the lights switched on, the condensation evaporates after a short time. The headlight glass does not need to be changed.

If despite driving with the headlights switched on, increasing humidity forms, for instance water droplets in the light, have the headlights checked.

Vehicle battery

General information

The battery is maintenance-free.

More information about the battery can be requested from a dealer's service center or another qualified service center or repair shop.

Safety information

DANGER

Contact with live components can lead to an electric shock. There is a risk of injury or danger to life. Do not touch any components that are under voltage.

Warning

Vehicle batteries that are not compatible can damage vehicle systems and impair vehicle functions. There is a risk of an accident and damage to property. Only vehicle batteries that are compatible with your vehicle type should be installed in your vehicle. Information on compatible vehicle batteries is available at your dealer's service center.

Register the battery to the vehicle

The manufacturer of the vehicle recommends that you have a service center or another qualified service center or repair shop register the vehicle battery to the vehicle after the battery has been replaced. Once the battery has been registered again, all comfort features will be available without restriction and any Check Control mes-

sages displayed which relate to comfort features will disappear.

Charging the battery

General information

Make sure that the battery is always sufficiently charged to guarantee that the battery remains usable for its full service life.



A discharged battery is indicated by a red indicator light.

Charge the battery when acceleration is insufficient.

The following circumstances can have a negative effect on the performance of the battery:

- ▷ Frequent short-distance drives.
- ▷ The vehicle is not used for more than a month.

Safety information

NOTICE

Battery chargers that charge the vehicle battery via sockets or cigarette lighters in the vehicle may overload or damage the 12 V electrical system. There is a risk of damage to property, among other potential damage. Only connect battery chargers for the vehicle battery to the starting aid terminals in the engine compartment.

Charging the battery

Charge the battery only when the engine is off and via the starting aid terminals in the engine compartment.

With Mild Hybrid technology: charge the battery only when the hood is opened.

Additional information:

Starting aid terminals, refer to page [367](#).

Power interruption

After a power interruption, some equipment needs to be newly initialized or individual settings updated, for example:

- ▷ With Memory function: store the positions again.
- ▷ Time: update.
- ▷ Date: update.
- ▷ Glass sunroof: initialize the system.

Mild Hybrid technology

Principle

Part of the Mild Hybrid technology is a battery that works with a voltage of 48 volts. Mild Hybrid technology can lower the fuel consumption.

Mild Hybrid technology influences the following functions.

Additional information:

- ▷ Auto Start/Stop function, refer to page [130](#).
- ▷ Engine-Off Coasting, refer to page [311](#).

Safety information

DANGER

Contact with live components can lead to an electric shock. There is a risk of injury or danger to life. Do not touch any components that are under voltage.

Overview

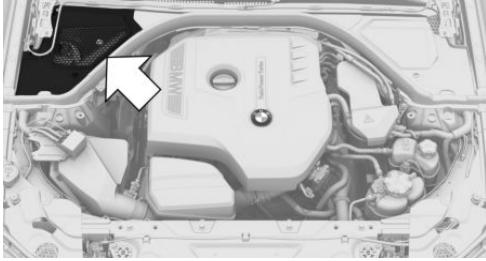

The battery for the Mild-Hybrid technology is located under a cover in the engine compartment on the front passenger side.

Removing the cover

1. Turn lid up to the opened lock symbol  arrow 1.

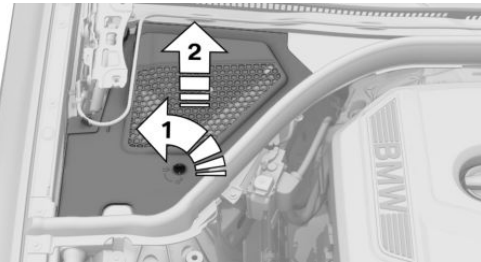

2. Remove cover, arrow 2.

Information

A purple cable leads from the battery to the center of the vehicle.

Do not replace or work on the battery for the Mild Hybrid technology.

Disposing of old batteries



Have old batteries disposed of by a dealer's service center or another qualified service center or repair shop or take them to a collection point.

Maintain the filled battery in an upright position for transport and storage. Secure the battery so that it does not tip over during transport.

Fuses

General information

The fuses are located at different places in the vehicle.

Safety information

Warning

Incorrect and repaired fuses can overload electrical lines and components. There is a risk of fire. Never attempt to repair a blown fuse. Do not replace a nonworking fuse with a substitute of another color or amperage rating.

In the car's interior

The fuses are located in the car's interior in the front passenger floor area behind a cover.

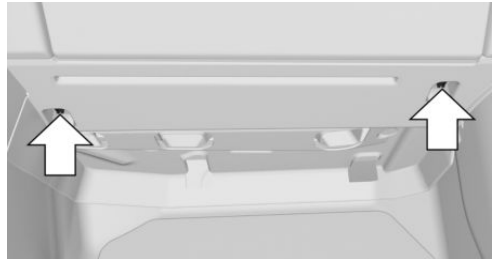

Loosen fasteners, arrows, and open cover.

The fuse box is located on the front right.

In the cargo area

The fuses are located in the cargo area on the right side behind a cover.



Remove the cover on the right side trim.

The fuse box may be located behind the sound insulation.

Information on the fuse layout, as well as the positions of any other fuse boxes, is available on the Internet: www.bmw.com/fusecard.

Additional fuse boxes

Additional fuse boxes are located in the vehicle. In the case of a malfunction, contact a dealer's service center or another qualified service center or repair shop.

Replacing fuses

The vehicle manufacturer recommends that you have a dealer's service center or another qualified service center or repair shop replace the fuses.

Breakdown Assistance

Vehicle features and options

This chapter describes all standard, country-specific and optional features offered with the series. It also describes features and functions that are not necessarily available in your vehicle, e.g., due to the selected options or country versions. This also applies to safety-related functions and systems. When using these functions and systems, the applicable laws and regulations must be observed.

Hazard warning flashers



The button is located in the center console.

The red light in the button flashes when the hazard warning flashers are activated.

Warning triangle

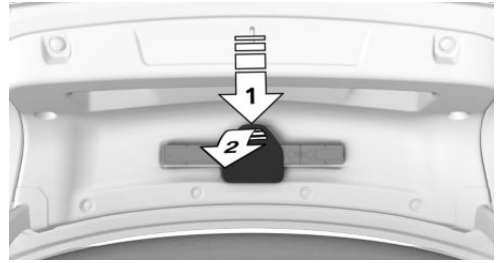

The warning triangle is located on the inside of the tailgate.

Press on the release, arrow 1, and swivel the cover down, arrow 2.

First-aid kit

General information

Some of the articles have a limited service life.

Check the expiration dates of the contents regularly and replace any expired items promptly.

Storage



Storage for the first-aid kit is provided in the right storage compartment of the cargo area.

BMW Roadside Assistance

Principle

Contact the BMW Group Roadside Assistance if assistance is needed in the event of a breakdown.

General information

In the event of a breakdown, data on the vehicle's condition is transmitted to the BMW Roadside Assistance.

There are various ways of contacting BMW Roadside Assistance.

- ▷ Via a Check Control message.
Supplementary text messages, refer to page 154.
- ▷ Calling with a mobile phone.
- ▷ Via the BMW app.

Functional requirements

- ▷ Active ConnectedDrive contract, equipment with intelligent emergency call or BMW ConnectedDrive services.
- ▷ Cellular network reception.
- ▷ Standby state is switched on.

Starting manually

If the vehicle is equipped with Teleservices, support is offered through Teleservice Diagnosis.

1. "APPS"
2. "Installed apps"
3. "BMW Assist"
4. If necessary, "BMW Roadside Assistance"
A voice connection is established.

Teleservice Diagnosis

Teleservice Diagnosis enables the wireless transmission of detailed vehicle data that is important for vehicle diagnosis. This data is trans-

mitted automatically. It may be necessary to approve this on the Control Display.

Teleservice Help

Depending on the country, Teleservice Help enables an in-depth diagnosis of the vehicle by BMW Roadside Assistance via wireless transmission.

You can launch Teleservice Help by requesting it through BMW Roadside Assistance.

1. Park the vehicle in a safe place.
2. Set the parking brake.
3. Control Display is switched on.
4. Confirm Teleservice Help.

BMW Accident Assistance

Principle

BMW Group Accident Assistance can be contacted if assistance is needed in the event of an accident.

General information

If the vehicle sensors detect a minor to moderately severe accident, which did not trigger any airbags, a Check Control message appears on the instrument cluster. In addition, a text message appears on the Control Display.

When BMW Accident Assistance is activated, data on the vehicle's condition is sent to BMW.

Functional requirements

- ▷ Active ConnectedDrive contract, equipment with intelligent emergency call or BMW ConnectedDrive services.
- ▷ Cellular network reception.
- ▷ Standby state is switched on.

Starting BMW Accident Assistance

If an accident is detected automatically

A text message relating to BMW Accident Assistance appears on the Control Display.

The connection can be established directly:

"Contact accident assistance"

The Check Control message for BMW Accident Assistance can also be called up from the stored Check Control messages for a certain length of time.

Additional information:

Check Control, refer to page 153.

Starting manually

BMW Accident Assistance can also be contacted independently of the automatic accident detection function.

1. "APPS"
2. "Installed apps"
3. "BMW Assist"
4. "BMW Accident Assistance"

Follow the displays on the Control Display. A voice connection is established.

Emergency Call

Intelligent emergency call

Principle

In case of an emergency, an emergency call can be triggered automatically by the system or manually.

General information

Only press the SOS button in an emergency.

The Intelligent Assist system establishes a connection with the BMW Response Center.

For technical reasons, the Emergency Call cannot be guaranteed under unfavorable conditions.

Overview



 SOS button.

Functional requirements

- ▶ Standby state is switched on.
- ▶ The Assist system is functional.
- ▶ If the vehicle is equipped with intelligent emergency call: the integrated SIM card in the vehicle has been activated.

Automatic triggering

Under certain conditions, for instance if the airbags trigger, an emergency call is automatically initiated immediately after an accident of corresponding severity. Automatic Collision Notification is not affected by pressing the SOS button.

Manual triggering

1. Tap the cover.
 2. Press and hold the SOS button until the LED in the area of the button illuminates green.
- ▶ The LED is illuminated green when an emergency call has been initiated.
- If a cancel prompt appears on the Control Display, the emergency call can be aborted.

If the situation allows, wait in your vehicle until the voice connection has been established.

- ▶ The LED flashes green when a connection to the BMW Response Center has been established.

The BMW Response Center then makes contact with the occupants of the vehicle and initiates further steps to help.

Even if you are unable to respond, the BMW Response Center can take further steps to help you under certain circumstances.

For this purpose, data that serves to determine the necessary rescue measures, for instance the current position of the vehicle when it can be determined, is transmitted to the BMW Response Center.

Even if the BMW Response Center is no longer heard through the loudspeakers, the BMW Response Center may still be able to hear the occupants of the vehicle.

The BMW Response Center ends the emergency call.

Malfunction

The function of the Emergency Request may be impaired.

The LED in the area of the SOS button lights up for approximately 30 seconds. A Check Control message is displayed.

Have it checked by a dealer's service center or another qualified service center or repair shop.

Jump-starting

General information

If the battery is discharged, the engine can be started using the battery of another vehicle and two jumper cables. Only use jumper cables with fully insulated clamp handles.

Safety information

DANGER

Contact with live components can lead to an electric shock. There is a risk of injury or danger to life. Do not touch any components that are under voltage.

Warning

If the jumper cables are connected in the incorrect order, sparking may occur. There is a risk of injury. Pay attention to the correct order during connection.

NOTICE

In the case of body contact between the two vehicles, a short circuit can occur during jump-starting. There is a risk of damage to property, among other potential damage. Make sure that no body contact occurs.

Preparation

1. Check whether the battery of the other vehicle has a voltage of 12 volts. The voltage information can be found on the battery.
2. Switch off the engine of the assisting vehicle.
3. Switch off any electrical components in both vehicles.

Starting aid terminals

The starting aid terminal in the engine compartment acts as the positive battery terminal.

A special connection on the body in the engine compartment acts as the negative battery terminal.

Additional information:

Overview of engine compartment, refer to page 347.

Open the cover of the positive battery terminal.

Connecting the cables

Before you begin, switch off all unnecessary electronic systems/components, such as the radio, on the assisting and receiving vehicles.

1. Open the cover of the starting aid terminal.
2. Attach one terminal clamp of the positive jumper cable to the positive battery terminal, or to the corresponding starting aid terminal of the vehicle providing assistance.
3. Attach the terminal clamp on the other end of the cable to the positive battery terminal, or to the corresponding starting aid terminal of the vehicle to be started.
4. Attach one terminal clamp of the negative jumper cable to the negative battery terminal, or to the corresponding engine or body ground of assisting vehicle.
5. Attach the second terminal clamp to the negative battery terminal, or to the corresponding engine or body ground of the vehicle to be started.

Starting the engine

Never use spray fluids to start the engine.

1. Start the engine of the assisting vehicle and let it run for several minutes at an increased idle speed.
2. Start the engine of the vehicle that is to be started in the usual way.
If the first starting attempt is not successful, wait a few minutes before making another attempt in order to allow the discharged battery to recharge.
3. Let both engines run for several minutes.
4. Disconnect the jumper cables in the reverse order.

Check the battery and recharge, if needed.

Tow-starting and towing

Safety information

Warning

Due to system limits, individual functions can malfunction during tow-starting/towing with the Intelligent Safety systems activated. There is a risk of accident. Switch all Intelligent Safety systems off prior to tow-starting/towing.

Steptronic transmission: transporting the vehicle

General information

The vehicle is not permitted to be towed.

Safety information

NOTICE

The vehicle can be damaged when towing the vehicle with a single lifted axle. There is a risk of damage to property, among other potential damage. The vehicle should only be transported on a loading platform.

NOTICE

The vehicle can become damaged when lifting and securing it.

There is a risk of damage to property, among other potential damage.

- ▷ Lift the vehicle using suitable means.
- ▷ Do not lift or secure the vehicle by its tow fitting, body parts, or suspension parts.

Pushing the vehicle

To remove a broken-down vehicle from the hazardous area, it can be pushed for a short distance.

Additional information:

Rolling or pushing the vehicle, refer to page 144.

Tow truck

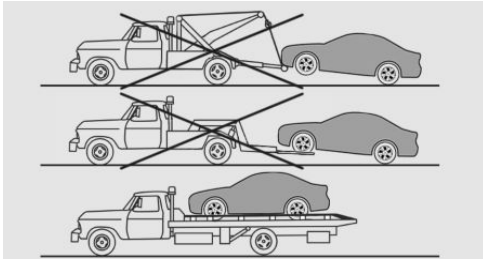

The vehicle should only be transported on a loading platform.

Towing other vehicles

General information

Switch on the hazard warning system, depending on local regulations.

If the electrical system has failed, clearly identify the vehicle being towed by placing a sign or a warning triangle in the rear window.

Safety information

Warning

If the approved gross vehicle weight of the towing vehicle is lighter than the vehicle to be towed, the tow fitting can tear off or it will not be possible to control handling. There is a risk of accident. Make sure that the gross vehicle weight of the towing vehicle is heavier than the vehicle to be towed.

NOTICE

If the tow bar or tow rope is attached incorrectly, damage to other vehicle parts can occur. There is a risk of damage to property, among other potential damage. Correctly attach the tow bar or tow rope to the tow fitting.

Tow bar

The tow fittings used should be on the same side on both vehicles.

Should it prove impossible to avoid mounting the tow bar at an inclination, please follow the following:

- ▶ Free movement is limited going around corners.
- ▶ The tow bar will generate lateral forces if it is secured with an inclination.

Tow rope

Observe the following notes when using the tow rope:

- ▶ Use nylon ropes or straps, which will enable the vehicle to be towed without jerking.
- ▶ Make sure the tow rope is not twisted when fastening.
- ▶ Check the attachment of the tow fitting and tow rope in regular intervals.
- ▶ Do not exceed a towing speed of 30 mph/50 km/h.
- ▶ Do not exceed a towing distance of 3 miles/5 km.
- ▶ When starting to tow the vehicle, make sure that the tow rope is taut.

Tow fitting

General information



The screw-in tow fitting should always be carried in the vehicle.

The tow fitting can be screwed in at the front or rear of the vehicle.

The tow fitting is found in the onboard vehicle tool kit.

Observe the following notes when using the tow fitting:

- ▶ Use only the tow fitting provided with the vehicle.
- ▶ Turn the tow fitting at least 5 turns clockwise and screw it in as far as it will go. If necessary, tighten with a suitable object.
- ▶ After use, unscrew the tow fitting counter-clockwise.
- ▶ Use the tow fitting for towing on paved roads only.
- ▶ Avoid lateral loading of the tow fitting, for instance do not lift the vehicle by the tow fitting.
- ▶ Check the attachment of the tow fitting in regular intervals.

Additional information:

Onboard vehicle tool kit, refer to page [359](#).

Safety information

NOTICE

If the tow fitting is not used as intended, there may be damage to the vehicle or to the tow fitting. There is a risk of damage to property, among other potential damage. Follow the notes on using the tow fitting.

Screw thread for tow fitting



Press on the mark on the edge of the cover to push it out.

For covers which have an opening instead of a marking, pull the cover out by the opening.

Tow-starting

Do not tow-start the vehicle.

Start the engine by jump-starting, if possible.

Have the reasons for the starting difficulties corrected by a dealer's service center or another qualified service center or repair shop.

Additional information:

Jump-starting, refer to page [367](#).

Vehicle Care

Vehicle features and options

This chapter describes all standard, country-specific and optional features offered with the series. It also describes features and functions that are not necessarily available in your vehicle, e.g., due to the selected options or country versions. This also applies to safety-related functions and systems. When using these functions and systems, the applicable laws and regulations must be observed.

Washing the vehicle

General information

Regularly remove foreign objects such as leaves in the area below the windshield when the hood is raised.

Wash your vehicle frequently, particularly in winter. Intense contamination and road salt can damage the vehicle.

Steam cleaner and high pressure cleaner

Safety information

NOTICE

When cleaning with high pressure cleaners, components can be damaged due to the pressure or temperatures being too high. There is a risk of damage to property, among other potential damage. Maintain sufficient distance and do not spray too long continuously. Follow the operating instructions for the high pressure cleaners.

Distances and temperature

- ▷ Maximum temperature: 140 °F/60 °C.
- ▷ Minimum distance from sensors, cameras, seals: 12 inches/30 cm.
- ▷ Minimum distance from glass sunroof: 31.5 in/80 cm.

Automatic washing systems or car washes

Safety information

NOTICE

Improper use of automatic washing systems or car washes can cause damage to the vehicle. There is a risk of damage to property, among other potential damage. Follow the following instructions:

- ▷ Give preference to cloth car washes or those that use soft brushes in order to avoid paint damage.
- ▷ Do not drive through a car wash with guide rails higher than 4 in/10 cm to avoid damage to the body.
- ▷ Observe the tire width of the guide rail to avoid damage to tires and rims.
- ▷ Fold in exterior mirrors to avoid damage to the exterior mirrors.
- ▷ Deactivate the wiper and, if necessary, rain sensor to avoid damage to the window wiper system.

Driving into a car wash with a Steptronic transmission

Safety information

NOTICE

Selector lever position P is automatically engaged when standby state is switched off. There is a risk of damage to property, among other potential damage. Do not switch standby state off in car washes.

General information

In a car wash, the vehicle must be able to roll freely.

Some car washes do not permit persons in the vehicle. The vehicle cannot be locked from the outside when in selector lever position N. A signal sounds when an attempt is made to lock the vehicle.

Additional information:

Rolling or pushing the vehicle, refer to page [144](#).

Driving out of a car wash

Ensure that the vehicle key is in the car.

Turn on drive readiness.

Additional information:

Drive-ready state, refer to page [42](#).

Headlights

Do not rub wet headlights dry and do not use abrasive or acidic cleaning agents.

Soak areas that have been dirtied, for instance from insects, with auto shampoo and wash off with water.

Thaw ice with de-icing spray; do not use an ice scraper.

After washing the vehicle

After washing the vehicle, apply the brakes briefly to dry them; otherwise, braking effect can

be reduced. The heat generated during braking dries brake discs and brake pads and protects them against corrosion.

Completely remove all residues on the windows, to minimize loss of visibility due to smearing and to reduce wiper noises and wiper blade wear.

Vehicle care

Vehicle care products

General information

BMW recommends using vehicle care and cleaning products from BMW. Suitable vehicle care products are available from a dealer's service center or another qualified service center or repair shop.

Safety information

Warning

Cleansers can contain substances that are dangerous and harmful to your health. There is a risk of injury. When cleaning the interior, open the doors or windows. Only use products intended for cleaning vehicles. Follow the instructions on the container.

Vehicle paintwork

General information

Regular vehicle care contributes to driving safety and value retention. Environmental influences in areas with elevated air pollution or natural contaminants, such as tree resin or pollen can affect the vehicle paintwork. Tailor the frequency and extent of your vehicle care to these influences.

Corrosive substances such as spilled fuel, oil, grease or bird droppings, must be removed immediately to prevent the finish from being altered or discolored.

Matte paintwork

Only use cleaning and care products suitable for vehicles with matte paintwork.

Leather care

Remove dust from the leather regularly, using a cloth or vacuum cleaner.

Otherwise, particles of dust and road grime chafe in pores and folds, and lead to heavy wear and premature degradation of the leather surface.

To guard against discoloration, such as from clothing, clean leather and provide leather care roughly every two months.

Clean light-colored leather more frequently because contamination on such surfaces is substantially more visible.

Use leather care products; otherwise, dirt and grease will gradually break down the protective coating of the leather surface.

Upholstery material care

General information

Vacuum the upholstery regularly with a vacuum cleaner.

If upholstery is very contaminated, for instance with beverage stains, use a soft sponge or micro-fiber cloth with a suitable interior cleaner.

Clean the upholstery down to the seams using large sweeping motions. Avoid rubbing the material vigorously.

Safety information

NOTICE

Open hook and loop fasteners on articles of clothing can damage the seat covers and other cloth upholstery in the vehicle. There is a risk of damage to property, among other potential damage. Ensure that any Velcro® fasteners are closed.

Caring for special components

Light-alloy wheels

When cleaning the vehicle, use only neutral rim cleaners having a pH value from 5 to 9. Do not use abrasive cleaning agents or steam cleaners above 140 °F/60 °C. Follow the manufacturer's instructions.

Aggressive, acidic or alkaline cleaning agents can destroy the protective coating of adjacent components, such as the brake disc.

After cleaning, apply the brakes shortly to dry them. The heat generated during braking dries brake discs and brake pads and protects them against corrosion.

Chrome surfaces

Carefully clean Chrome surfaces, especially in case of exposure to road salt, with plenty of water and added auto shampoo as needed.

Rubber components

Environmental influences can cause surface contamination of rubber parts and a loss of gloss. Use only water and suitable cleaning agents for cleaning.

Treat especially worn rubber parts with rubber care products at regular intervals. When cleaning rubber seals, do not use any silicon-containing vehicle care products in order to avoid damage or noises.

Fine wood parts

Clean fine wood facing and fine wood components only with a moist rag. Then dry with a soft cloth.

Kenaf

Only treat parts made of Kenaf fibers using suitable care products.

Plastic components

NOTICE

Cleaning agents that contain alcohol or solvents, such as lacquer thinners, heavy-duty grease removers, fuel and such, can damage plastic parts. There is a risk of damage to property, among other potential damage. Clean with a microfiber cloth. Dampen the cloth lightly with water, if needed.

Clean with a microfiber cloth.

Dampen the cloth lightly with water, if needed.

Do not soak the headliner.

Safety belts

Warning

Chemical cleansers can destroy the safety belt webbing. Missing protective effect of the safety belts. There is a risk of injury or danger to life. Use only a mild soapy solution for cleaning the safety belts.

Dirty belt straps impede the reeling action and thus have a negative impact on safety.

Use only a mild soapy solution for cleaning the installed belt straps.

Safety belts should only be allowed to retract if they are dry.

Carpets and floor mats

Warning

Objects in the driver's floor area can limit the pedal distance or block a depressed pedal. There is a risk of accident. Stow objects in the vehicle such that they are secured and cannot enter into the driver's floor area. Use floor mats that are suitable for the vehicle and can be safely attached to the floor. Do not use loose floor mats and do not layer several floor mats.

Make sure that there is sufficient clearance for the pedals. Ensure that the floor mats are securely fastened again after they were removed, for instance for cleaning.

The floor mats can be removed from the car's interior for cleaning.

If the floor carpets are very contaminated, clean with a microfiber cloth and water or a textile cleaner. To prevent matting of the carpet, rub back and forth in the driving direction only.

Sensors and camera lenses

To clean sensors and camera lenses, use a cloth moistened with a small amount of glass detergent.

Displays, screens, and protective glass of the Head-up Display

NOTICE

Chemical cleaning agents, moisture or fluids of any kind can damage the surface of displays and screens. There is a risk of damage to property, among other potential damage. Clean with a clean, antistatic microfiber cloth.

NOTICE

The surface of displays can be damaged with improper cleaning. There is a risk of damage to property, among other potential damage. Avoid pressure that is too high and do not use any scratching materials.

Use a dry, clean antistatic microfiber cloth.

Clean the protective glass of the Head-up Display using a microfiber cloth and commercially available dish-washing soap.

Taking the vehicle out of service

When the vehicle is shut down for longer than three months, special measures must be taken.

Further information is available from a dealer's service center or another qualified service center or repair shop.

Technical data

Vehicle features and options

This chapter describes all standard, country-specific and optional features offered with the series. It also describes features and functions that are

not necessarily available in your vehicle, e.g., due to the selected options or country versions. This also applies to safety-related functions and systems. When using these functions and systems, the applicable laws and regulations must be observed.

General information

The technical data and specifications in the Owner's Manual are used as guidance values. The vehicle-specific data can deviate from this, for instance due to the selected optional equipment, country version or country-specific meas-

uring procedure. Detailed values can be found in the approval documents, on labels on the vehicle or can be obtained from a dealer's service center or another qualified service center or repair shop.

Dimensions

The dimensions can vary depending on the model version, equipment version or country-specific measurement procedure.

The height of the vehicle can also differ, e.g. due to tires and vehicle load.

BMW 3 Series Sedan

| | | |
|-------------------------------|-------|-------------|
| Width with mirrors | in/mm | 81.4/2,068 |
| Width without mirrors | in/mm | 71.9/1,827 |
| Height | in/mm | 57/1,448 |
| Length | in/mm | 185.7/4,718 |
| Wheelbase | in/mm | 112.2/2,851 |
| Smallest turning radius diam. | ft/m | 39.4/12.0 |

Weights

330i

| | | |
|-------------------------------|--------|-------------|
| Approved gross vehicle weight | lbs/kg | 4,586/2,080 |
| Payload | lbs/kg | 836/379 |
| Approved front axle weight | lbs/kg | 2,194/995 |
| Approved rear axle weight | lbs/kg | 2,557/1,160 |

330i xDrive

| | | |
|-------------------------------|--------|-------------|
| Approved gross vehicle weight | lbs/kg | 4,773/2,165 |
| Payload | lbs/kg | 899/408 |
| Approved front axle weight | lbs/kg | 2,326/1,055 |
| Approved rear axle weight | lbs/kg | 2,601/1,180 |

M340i powered by BMW M

| | | |
|-------------------------------|--------|-------------|
| Approved gross vehicle weight | lbs/kg | 4,905/2,225 |
| Payload | lbs/kg | 959/435 |
| Approved front axle weight | lbs/kg | 2,425/1,100 |
| Approved rear axle weight | lbs/kg | 2,701/1,225 |

M340i xDrive powered by BMW M

| | | |
|-------------------------------|--------|-------------|
| Approved gross vehicle weight | lbs/kg | 5,027/2,280 |
| Payload | lbs/kg | 957/434 |
| Approved front axle weight | lbs/kg | 2,524/1,145 |
| Approved rear axle weight | lbs/kg | 2,723/1,235 |

Filling capacities

BMW 3 Series Sedan

| | | |
|--------------------|---------------|-----------|
| Fuel tank, approx. | US gal/liters | 15.6/59.0 |
|--------------------|---------------|-----------|

Observe further information on fuel quality, refer to page [350](#).

Appendix

General information

Any updates to the Owner's Manual of the vehicle are listed here.

Updates made after the editorial deadline

The following chapters were updated in the printed version of the Owner's Manual after the editorial deadline for the Integrated Owner's Manual in the vehicle had closed:

- ▶ Opening and closing: BMW Digital Key: general.

Everything from A to Z

Index

0-9

3D View, see Surround View [254](#)
48V technology, see Mild Hybrid technology [361](#)

A

ABS Antilock Braking System [212](#)
Acceleration Assistant, see Launch Control [147](#)
Accessories and parts [8](#)
Accident prevention, see Active Protection [209](#)
ACC, see Active Cruise Control [220](#)
Activated charcoal filter [275](#)
Active Blind Spot Detection [199](#)
Active Cruise Control with Stop&Go function ACC [220](#)
Active damping control, see Adaptive M chassis/suspension [265](#)
Active Guard Plus, see Intelligent Safety [183](#)
Active Guard, see Intelligent Safety [183](#)
Active M Sport differential [215](#)
Active PDC, see Emergency brake function [243](#)
Active Protection [209](#)
Adaptive brake assistant [212](#)
Adaptive Light Control [174](#)
Adaptive M chassis/suspension [265](#)
ADAPTIVE, see Driving Dynamics Control [135](#)
Adding engine oil types [353](#)
Adding oil [352](#)
Additives, engine oil types [353](#)
Adjusting contents, iDrive [49](#)
Adjusting engine sound [265](#)
Adjusting sound of the engine [265](#)
Adjustments, steering wheel [120](#)
Airbags [179](#)
Airbags, indicator and warning light [181](#)
Air circulation, see Recirculated-air mode [268](#), [273](#)
air conditioning, climate [271](#)
Air distribution, manual [269](#), [274](#)
Air drying, see air conditioning [271](#)
Air flow, automatic climate control [269](#), [273](#)
Air outlets, see Ventilation [275](#)
Air pressure, tires [316](#)
Air quality [266](#)
Alarm system [103](#)
Alarm, unintentional [104](#)
All-season tires, see Winter tires [325](#)
All-wheel-drive, see xDrive [214](#)
Ambient light [177](#)
Android Auto, connection to the vehicle [79](#)
Android Auto preparation, connection to the vehicle [79](#)
Android Auto preparation, smartphone integration [79](#)
Antifreeze, see Washer fluid [355](#)
Antilock Braking System ABS [212](#)
Anti-slip control, see DSC [212](#)
Anti-theft protection, lug bolt lock [343](#)
Apple CarPlay preparation, connection to the vehicle [79](#)
Apple CarPlay preparation, smartphone integration [79](#)
Approach control warning with City braking function [184](#)
Approach control warning with light braking function [184](#)
Apps, see Owner's Handbook for Navigation, Entertainment, Communication [6](#)
Aquaplaning [303](#)
Ashtray [285](#)
Assistance when driving off, see Drive-off assistant [212](#)
Assistance with breakdown [364](#)
Assisted Driving Mode, see Steering Assistant [230](#)
Assisted Driving Plus [234](#)
Assisted Driving View [149](#)

- Audio, see Owner's Manual for Navigation, Entertainment and Communication [6](#)
- AUTO H button, see Parking brake [135](#)
- Automatic activation, see Climate control rules [122](#)
- Automatic car wash [371](#)
- Automatic climate control [266](#), [270](#)
- Automatic control, headlight [171](#)
- Automatic Curb Monitor, exterior mirror [119](#)
- Automatic deactivation, front-seat passenger airbags [182](#)
- Automatic headlight control [171](#)
- Automatic High Beam Assistant [174](#)
- Automatic Hold, see Parking brake [135](#)
- Automatic locking [102](#)
- Automatic Parking Assistant [247](#)
- Automatic Recirculating Air Control [273](#)
- Automatic time setting [63](#)
- Automatic transmission, see Steptronic transmission [142](#)
- Automatic unlocking [102](#)
- Automating routines, BMW Intelligent Personal Assistant [55](#)
- AUTO program, automatic climate control [268](#), [272](#)
- AUTO program, intensity [272](#)
- Auto Start/Stop function [130](#)
- Average consumption, see Trip data [166](#)
- Axle loads, approved [377](#)
- Blu-ray, see Owner's Handbook for Navigation, Entertainment, Communication [6](#)
- BMW Accident Assistance [365](#)
- BMW Assist, see Owner's Manual for Navigation, Entertainment and Communication [6](#)
- BMW Digital Key [88](#)
- BMW Drive Recorder [207](#)
- BMW Gesture Control [56](#)
- BMW Intelligent Personal Assistant [52](#)
- BMW maintenance system [357](#)
- BMW Roadside Assistance [365](#)
- Bonus range, ECO PRO [310](#)
- Bottle holder, front, see Cup holder, front [294](#)
- Bottle holder, rear, see Cup holder, rear [294](#)
- Brake assistant [212](#)
- Brake assistant, adaptive [212](#)
- Brake discs, see Brake system [302](#)
- Brake-in [302](#)
- Brake pads, see Brake system [302](#)
- Brake system [302](#)
- Braking, information [304](#)
- Breakdown assistance [364](#)
- Breaking in [302](#)
- Break recommendation, see Fatigue alert [210](#)
- Brightness, Control Display [65](#)
- Button, central locking system [93](#)
- Buttons on the steering wheel [32](#)
- Button, SOS, see Intelligent emergency call [366](#)
- Button, Start/Stop [130](#)
- Bypassing, see Jump-starting [367](#)

B

- Backrest curvature, see Lumbar support [112](#)
- Backrest, seats [109](#)
- Backrest tilt [111](#)
- Backrest, width [112](#)
- Bandages, see First-aid kit [364](#)
- Bar for tow-starting/towing [369](#)
- Battery, disposing of [362](#)
- Battery, vehicle [360](#)
- Being towed, see Tow-starting and towing [368](#)
- Belts, see Safety belts [112](#)
- Blind spot collision warning [199](#)
- Blocking, power window, see Safety switch [106](#)
- Bluetooth connection [76](#)

C

- Cable for tow-starting/towing [369](#)
- Calendar day, see Date [63](#)
- California Proposition 65 Warning [8](#)
- Call, gesture control [57](#)
- Camera-based assistance systems, see Intelligent Safety [183](#)
- Camera instrument cluster, see Driver Attention Camera [64](#)
- Camera lenses, care [374](#)
- Camera, rearview camera, see Surround View [254](#)
- Camera, rearview camera, without Surround View [244](#)

- Camera, see Surround View [254](#)
- Cameras, see Sensors of the vehicle [37](#)
- CANCEL button, Active Cruise Control [220](#)
- CANCEL button, cruise control [218](#)
- Can holder, front, see Cup holder, front [294](#)
- Can holder, rear, see Cup holder, rear [294](#)
- Care [371](#)
- Care, Head-up Display [374](#)
- Care, light-alloy wheels [373](#)
- Care of displays, screens [374](#)
- Care, vehicle [372](#)
- Cargo [296](#)
- Cargo area [296](#)
- Cargo area, enlarging [298](#)
- Cargo area with emergency wheel, enlarging [300](#)
- Cargo, stowing and securing [297](#)
- Cargo straps, see Lashing eyes in the cargo area [297](#)
- Caring Car, BMW Intelligent Personal Assistant [55](#)
- Car key, see Vehicle key [82](#)
- Carpet, care [374](#)
- CarPlay, connection to the vehicle [79](#)
- Car seats, see Transporting children safely [124](#)
- Car wash [371](#)
- Car wash, automatic [371](#)
- Catalytic converter, see Hot exhaust gas system [303](#)
- CBS Condition Based Service [357](#)
- Cell phone, see Owner's Manual for Navigation, Entertainment and Communication [6](#)
- Center armrest, front [294](#)
- Center console [35](#)
- Central Information Display (CID), see Control Display [47](#)
- Central locking switch, see Central locking system [93](#)
- Central locking system [93](#)
- Central screen, see Control Display [47](#)
- Changes, technical, see For Your Own Safety [8](#)
- Change, wheels and tires [324](#)
- Changing parts [359](#)
- Changing wheels [341](#)
- Charging smartphone, see Wireless charging tray [289](#)
- Charging tray for smartphones, see Wireless charging tray [289](#)
- Chassis/suspension, electronic, see Adaptive M chassis/suspension [265](#)
- Chassis number, see Vehicle identification number [12](#)
- Check Control [153](#)
- Checking the engine oil level electronically [352](#)
- Children, seating position [124](#)
- Children, transporting safely [124](#)
- Child restraint systems, mounting [125](#)
- Child restraint systems, see Transporting children safely [124](#)
- Child safety locks [129](#)
- Child seat, mounting [125](#)
- Child seat mountings LATCH [126](#)
- Child seats, see Transporting children safely [124](#)
- Chrome-plated surfaces, care [373](#)
- Chrome surfaces, care [373](#)
- Cigarette lighter [286](#)
- Cigarette lighter, front [286](#)
- Cleaning displays, screens [374](#)
- Cleaning, Head-up Display [374](#)
- Clearance, water [303](#)
- Climate control [266](#)
- Climate control rules [122](#)
- Closing with the Key Card [87](#)
- Closing with the smartphone, see BMW Digital Key [88](#)
- Clothes hooks [295](#)
- Coasting [311](#)
- Coasting with engine decoupled, see Coasting [311](#)
- Coasting with idling engine [311](#)
- Combination switch, see Turn signals [138](#)
- Combination switch, see Washer/wiper system [139](#)
- Comfort Access [93](#)
- COMFORT, see Driving Dynamics Control [133](#)
- Communication, see Owner's Manual for Navigation, Entertainment and Communication [6](#)
- Compact wheel, see Emergency wheel [345](#)
- Comparison of entries, see Entry comparison [45](#)
- Compartments in the doors [293](#)
- Compass [153](#)

- Compatible devices, see Suitable devices [74](#)
- Compressor [327](#)
- Concierge Service, see Owner's Handbook for Navigation, Entertainment, Communication [6](#)
- Condensation water under the parked vehicle [305](#)
- Condensation, windshield [269](#), [274](#)
- Condition Based Service CBS [357](#)
- Confirmation signal from the vehicle [102](#)
- Connect device [73](#)
- ConnectedDrive, see Owner's Manual for Navigation, Entertainment and Communication [6](#)
- Connecting electrical devices, see Sockets [286](#)
- Connecting, mobile devices [73](#)
- Connections, Screen Mirroring [78](#)
- Consumption display, ECO PRO [310](#)
- Consumption display, widget in the instrument cluster [151](#), [152](#)
- Consumption, see Current consumption [151](#), [152](#)
- Consumption, see Trip data [166](#)
- Contacts, see Owner's Handbook for Navigation, Entertainment, Communication [6](#)
- Container for washer fluid [355](#)
- Continued driving with a flat tire [337](#), [340](#)
- Control Display [47](#)
- Control Display, brightness [65](#)
- Control display, pop-ups [65](#)
- Controller [48](#)
- Control systems, driving stability [212](#)
- Convenient closing, vehicle key [84](#)
- Convenient opening, vehicle key [83](#)
- Coolant [354](#)
- Coolant level [355](#)
- Coolant temperature, see Engine temperature [161](#)
- Cooling, maximum [268](#), [272](#)
- Cooling system [354](#)
- Cornering light [174](#)
- Corrosion on brake discs [305](#)
- Cosmetic mirror [285](#)
- Cross traffic warning [262](#)
- Cruise control [218](#)
- Cruise control, active with Stop&Go function [220](#)
- Cruise control, see Active Cruise Control [220](#)
- Cruise control with distance control, see Active Cruise Control with Stop&Go function [220](#)
- Cruise control without distance control, see Cruise control [218](#)
- Cruising range [162](#)
- Cup holder, front [294](#)
- Cup holder, rear [294](#)
- Current consumption [151](#), [152](#)
- Customer service, see Owner's Manual for Navigation, Entertainment, Communication [6](#)
- ## D
- Damage, tires [323](#)
- Damping control active, see Adaptive M chassis/suspension [265](#)
- Dashboard [32](#)
- Dashboard, see Instrument cluster [148](#)
- Dashcam, see BMW Drive Recorder [207](#)
- Data memory [10](#)
- Data protection, settings [68](#)
- Data, see Deleting personal data [68](#)
- Data, technical [376](#)
- Date [63](#)
- Daytime driving lights [173](#)
- Daytime running lights [173](#)
- DCC, see Cruise control [218](#)
- Defrosting, see Defrosting windshield [269](#), [274](#)
- Defrosting, windshield [269](#), [274](#)
- Deleting personal data [68](#)
- Departure schedule, see Pre-ventilation [277](#)
- Departure time, pre-conditioning [280](#)
- Departure time, pre-ventilation [278](#)
- Destination distance, trip computer [152](#)
- Destination input [6](#)
- Device list [74](#)
- Diagnosis connection [358](#)
- Differential lock [215](#)
- Digital Key [88](#)
- Digital Key, see BMW Digital Key [88](#)
- Dimensions [376](#)
- Dimmable exterior mirrors [119](#)
- Dimmable interior mirror [120](#)
- Direct dial buttons, see Programmable memory buttons [46](#)
- Direction indicator, see Turn signals [138](#)

- Display, iDrive [44](#)
Display in the windshield, see Head-up Display [168](#)
Display lighting, see Instrument lighting [177](#)
Display, notifications, BMW Intelligent Personal Assistant [66](#)
Display panel, see Instrument cluster [148](#)
Displays [148](#)
Displays and symbols [7](#)
Displays, ECO PRO [308](#)
Display speed limit, see Speed Limit Info [164](#)
Disposal, coolant [355](#)
Disposal, vehicle battery [362](#)
Distance control, see PDC [240](#)
Distance to destination, trip computer [152](#)
Door handle lighting, see Welcome lights [173](#)
Door opening angle, Surround View [255](#)
Drive-off assistant [212](#)
Drive-off assistant, see DSC [212](#)
Drive power reduced, see Heavily discharged high-voltage battery [160](#)
Driver activity, see Driver Attention Camera [64](#)
Driver assistance, driving, see Intelligent Safety [183](#)
Driver assistance, parking, see Parking assistance systems [239](#)
Driver assistance, see Intelligent Safety [183](#)
Driver assistance systems [216](#)
Driver Attention Camera [64](#)
Drive readiness, see Operating condition of the vehicle [41](#)
Drive-ready state, engine start [42](#)
Driver Fatigue Alert, see Driver Attention Camera [64](#)
Driver profiles [69](#)
Driver profile, setup [69](#)
Driver profiles, welcome screen [69](#)
Driving [130](#)
Driving Assistant, see Intelligent Safety [183](#)
Driving comfort [265](#)
Driving Dynamics Control [133](#)
Driving instructions, breaking in [302](#)
Driving mode, ECO PRO [308](#)
Driving mode, see Driving Dynamics Control [133](#)
Driving notes, general [303](#)
Driving out of parking space [251](#)
Driving stability control systems [212](#)
Driving, Start/Stop button [130](#)
Driving style analysis, ECO PRO [312](#)
Driving through water [303](#)
Driving tips [303](#)
DSC Dynamic Stability Control [212](#)
DTC Dynamic Traction Control [214](#)
Dynamic damping, see Adaptive M chassis/suspension [265](#)
Dynamic Stability Control [212](#)
Dynamic Stability Control DSC [212](#)
Dynamic Traction Control DTC [214](#)
- ## E
- ECO PRO [308](#)
ECO PRO, bonus range [310](#)
ECO PRO, driving style analysis [312](#)
ECO PRO INDIVIDUAL, see Driving Dynamics Control [133](#)
ECO PRO, see Driving Dynamics Control [133](#)
Efficiency display, widget in the instrument cluster [151](#), [152](#)
Efficient4x4, see xDrive [214](#)
Electronic oil measurement [352](#)
Electronic Stability Program ESP, see DSC [212](#)
E-mail, see Owner's Handbook for Navigation, Entertainment, Communication [6](#)
Emergency brake function when parking, Active PDC [243](#)
Emergency brake, see Emergency stop assistant [206](#)
Emergency braking, see PostCrash - iBrake [210](#)
Emergency call [366](#)
Emergency service, see BMW Accident Assistance [365](#)
Emergency service, see BMW Roadside Assistance [365](#)
Emergency stop assistant [206](#)
Emergency unlocking, fuel filler flap [315](#)
Emergency unlocking, transmission lock [146](#)
Emergency unlocking, trunk lid [100](#)
Emergency wheel [345](#)
Energy recovery [151](#), [152](#)
Energy savings, see Gear shift indicator [163](#)

- Engine, automatic Start/Stop function [130](#)
 Engine compartment [347](#)
 Engine coolant [354](#)
 Engine idling when driving, see [Coasting 311](#)
 Engine oil, adding [352](#)
 Engine oil change [354](#)
 Engine oil filler neck [352](#)
 Engine oil temperature [161](#)
 Engine oil types to add [353](#)
 Engine start, see [Drive-ready state 42](#)
 Engine start, see [Jump-starting 367](#)
 Engine stopping, see [Drive-ready state 42](#)
 Engine temperature [161](#)
 Entering a destination, see [Owner's Handbook for Navigation, Entertainment, Communication 6](#)
 Entering an address, navigation, see [Owner's Manual for Navigation, Entertainment and Communication 6](#)
 Entertainment, see [Owner's Manual for Navigation, Entertainment and Communication 6](#)
 Entertainment, selection list in the instrument cluster [165](#)
 Entry comparison [45](#)
 Equipment, interior [282](#)
 Error indicators, see [Check Control 153](#)
 ESP Electronic Stability Program, see [DSC 212](#)
 Evasion Assistant [187](#)
 Exchange, wheels and tires [324](#)
 Exhaust gas system [303](#)
 Exhaustion warner [210](#)
 Exhaust, see [Exhaust gas system 303](#)
 Exterior lighting during unlocking [83](#)
 Exterior lighting with the vehicle locked [84](#)
 Exterior mirror, Automatic Curb Monitor [119](#)
 Exterior mirror, automatic dimming feature [119](#)
 Exterior mirrors [118](#)
 Exterior mirrors, malfunction [119](#)
 External start, see [Jump-starting 367](#)
 Eyelet for towing [370](#)
 Eyes, see [Lashing eyes in the cargo area 297](#)
- F**
- Factory settings, see [reset vehicle data 65](#)
 Failure message, see [Check Control 153](#)
 Fan, see [Air flow 269, 273](#)
 Fastening safety belts, see [Safety belts 112](#)
 Fatigue alert [210](#)
 Fault indicators, see [Check Control 153](#)
 Filler neck for engine oil [352](#)
 Filter, see [Interior filter 266](#)
 Filter, see [Microfilter 269](#)
 Fine wood parts, care [373](#)
 First-aid kit [364](#)
 First Steps, see [Setup Wizard 69](#)
 Flat tire, changing wheels [341](#)
 Flat tire, continued driving [337, 340](#)
 Flat tire, Flat Tire Monitor TPM [338](#)
 Flat tire message, FTM [339](#)
 Flat tire message, Tire Pressure Monitor [335](#)
 Flat Tire Monitor TPM [338](#)
 Flat tire, repairing [326](#)
 Flat tire, see [Tire Pressure Monitor 331](#)
 Flat tire warning light, FTM [339](#)
 Flat tire warning light, see [Tire Pressure Monitor 335](#)
 Flooding, driving through [303](#)
 Floor carpet, care [374](#)
 Floor mats, care [374](#)
 Fold-away position, wiper [141](#)
 Foot brake [304](#)
 Forward collision mitigation, see [Intelligent Safety 183](#)
 For Your Own Safety [8](#)
 Front airbags [179](#)
 Front collision mitigation [184](#)
 Front collision mitigation, see [Forward Collision Warning 184](#)
 Front collision mitigation, see [Intersection Collision Warning 189](#)
 Front collision mitigation, see [Pedestrian Warning 193](#)
 Front fog lights [176](#)
 Front fog lights, replacing, see [Lights and bulbs 360](#)
 Front lights, replacing, see [Lights and bulbs 360](#)
 Front passenger airbags [182](#)
 Front passenger airbags, automatic deactivation [182](#)
 Front-seat passenger airbags, indicator light [182](#)
 Front seats [109](#)

Fuel 350
 Fuel cap 314
 Fuel filler flap 314
 Fuel filler flap, unlocking manually 315
 Fuel gauge 159
 Fuel quality 350
 Fuel recommendation 350
 Fuel tank, see Filling capacity 378
 Fuses 362

G

Garage door opener, see Integrated Universal Remote Control 282
 Gasoline 350
 Gasoline quality 351
 Gear change, Steptronic transmission 142
 Gear shift indicator 163
 General driving notes 303
 General settings 63
 Gesture Control 56
 Gestures, see BMW Gesture Control 56
 Glare shield, see Sun visor 285
 Glass sunroof, electric 106
 Glass sunroof, initialize the system 108
 Global Positioning System, navigation 6
 Glove compartment 292
 G-meter, widget in the instrument cluster 151
 GPS, navigation, see Owner's Handbook for Navigation, Entertainment, Communication 6
 Gross vehicle weight, approved 377

H

Handbrake, see Parking brake 135
 Hand-held transmitter, alternating code 283
 Hands-free device, see Owner's Handbook for Navigation, Entertainment, Communication 6
 Hazard warning system 364
 Head airbag 180
 Headlight control, automatic 171
 Headlight flasher 139
 Headlight glass 360
 Headlights, care 372
 Headlights, replacing, see Lights and bulbs 360
 Head restraints and seats 109

Head restraints, front 115
 Head restraints, rear 117
 Head-up Display 168
 Head-up Display, care 374
 Head-up Display, store position, see Memory function 121
 Heated steering wheel 120
 Heated steering wheel, climate control rules 122
 Heavy cargo, stowing 297
 Height, vehicle 376
 High-beam Assistant 174
 High beams 139
 High beams/low beams, see High-beam Assistant 174
 Hills 304
 Hill start assistant, see Drive-off assistant 212
 Holder for beverages, front 294
 Holder for beverages, rear 294
 HomeLink, see Integrated Universal Remote Control 282
 Homepage, see Internet 6
 Hood 348
 Horn 32
 Hotel function, see Valet parking mode 100
 Hot exhaust gas system 303
 Hour, see Time 63
 Humidity in the headlight, see Headlight glass 360

I

iBrake - PostCrash 210
 Ice, see Outside temperature 162
 Ice warning, see Outside temperature 162
 Identification marks, tires 321
 Identification number, see Vehicle identification number 12
 iDrive 44
 ID transmitter, see Vehicle key 82
 Ignition key, see Vehicle key 82
 Indicator light, front-seat passenger airbags 182
 Indicator lights 154
 Individual air distribution 269, 274
 Individual settings, see Driver profiles 69
 Inductive charging, smartphone, see Wireless charging tray 289

Inflation pressure, tires [316](#)
Inflation pressure warning TPM, tires [338](#)
Information [6](#)
Initialization, Flat Tire Monitor FTM [339](#)
Input, iDrive [44](#)
Instrument cluster [148](#)
Instrument lighting [177](#)
Instrument panel, see Instrument cluster [148](#)
Integrated key [91](#)
Integrated Owner's Manual in the vehicle [14](#)
Integrated Universal Remote Control [282](#)
Intelligent emergency call [366](#)
Intelligent Personal Assistant [52](#)
Intelligent Safety [183](#)
Intended use [8](#)
Intensity, AUTO program [272](#)
Interior equipment [282](#)
Interior filter [266](#)
Interior lights [177](#)
Interior lights during unlocking [83](#)
Interior lights with the vehicle locked [84](#)
Interior mirror, automatic dimming feature [120](#)
Interior mirrors [120](#)
Interior motion sensor [104](#)
Internet hotspot [77](#)
Internet page [6](#)
Intersection collision warning [189](#)
Interval indicator, see Service notifications [163](#)

J

Jacking points for the vehicle jack [343](#)
Jam protection system, glass sunroof [108](#)
Jam protection system, windows [106](#)
Joystick, Steptronic transmission [142](#)
Jump-starting [367](#)
Jump-starting terminals [367](#)

K

Kenaf, care [373](#)
Key Card [87](#)
Keyless Go, see Comfort Access [93](#)
Key, mechanical [91](#)
Key, see Vehicle key [82](#)
Kickdown, Steptronic transmission [142](#)

Knee airbag [180](#)

L

Label on recommended tires [325](#)
Lane change assistant [236](#)
Lane control assistant with active side collision protection, see Side collision mitigation [202](#)
Lane departure warning [195](#)
Lane lines, Surround View [255](#)
Lane threshold, warning [195](#)
Language, setting [64](#)
Laser headlights, replacing, see Lights and bulbs [360](#)
Laser high beams [176](#)
Lashing eyes in the cargo area [297](#)
LATCH child seat mountings [126](#)
Launch Control [147](#)
Leather care [373](#)
LED front fog lights, replacing, see Lights and bulbs [360](#)
LED headlights, replacing, see Lights and bulbs [360](#)
LED light carpet, see Welcome light [173](#)
Length, vehicle [376](#)
Letters and numbers, entering [45](#)
Light-alloy wheels, care [373](#)
Light control, adaptive [174](#)
Lighter, cigarettes [286](#)
Lighting [171](#)
Light in the exterior mirror, see Active Blind Spot Detection [199](#)
Light in the exterior mirror, see Cross traffic warning [262](#)
Light replacement, see Lights and bulbs [360](#)
Lights [171](#)
Lights and bulbs [360](#)
Light switch [171](#)
LIM button, see Manual Speed Limiter [216](#)
List, instrument cluster, see Selection lists [165](#)
List of all messages [66](#)
List of all notifications [66](#)
Load [297](#)
Loading [296](#)
Loading the cargo area, see Stowing cargo [297](#)
Local time, see Time [63](#)

Lock control elements, rear automatic climate control [277](#)
Locking, automatic [102](#)
Locking, see Opening and Closing [82](#)
Locking, settings [102](#)
Locking the trunk lid, see Valet parking mode [100](#)
Locking, vehicle key [83](#)
Lock, lug bolts [343](#)
Low beams, automatic, see High-beam Assistant [174](#)
Low beams, operation [172](#)
Lower back support, see Lumbar support [112](#)
Lug bolt lock [343](#)
Luggage rack, see Roof-mounted luggage rack [305](#)
Lumbar support [112](#)

M

Maintenance [357](#)
Maintenance recommendations [357](#)
Maintenance recommendations, see Condition Based Service CBS [357](#)
Maintenance, see Service notifications [163](#)
Maintenance system, BMW [357](#)
Make-up mirror [285](#)
Malfunction, vehicle key [86](#)
Managing devices [74](#)
Manual brake, see Parking brake [135](#)
Manual control, air distribution [269](#), [274](#)
Manual control, air flow [269](#), [273](#)
Manual mode, Steptronic transmission [142](#)
Manual operation, fuel filler flap [315](#)
Manual Speed Limiter [216](#)
Map update, see Owner's Handbook for Navigation, Entertainment, Communication [6](#)
Marking, run-flat tire [326](#)
Matt paint, care [373](#)
Maximum cooling [268](#), [272](#)
Maximum speed, display, see Speed Limit Info [164](#)
Maximum speed, winter tires [325](#)
M chassis/suspension, adaptive, see Adaptive M chassis/suspension [265](#)
Media of the Owner's Manual [14](#)

Medical supplies, see First-aid kit [364](#)
Memory function [121](#)
Menu, instrument cluster, see Selection lists [165](#)
Menus, operating, iDrive [44](#)
Messages [66](#)
Messages, see Check Control [153](#)
Meters, see Instrument cluster [148](#)
Microfilter [269](#), [275](#)
Mild Hybrid technology [361](#)
Minimum tread depth, tires [323](#)
Mobile communication devices in the vehicle [303](#)
Mobile devices, managing [74](#)
Mobile phone, connecting [73](#)
Mobile phone, see Owner's Manual for Navigation, Entertainment and Communication [6](#)
Mobile Service, see BMW Accident Assistance [365](#)
Mobile Service, see BMW Roadside Assistance [365](#)
Mobility System, see Tire repair set [327](#)
MODE button, see Active Cruise Control [220](#)
Mode, ECO PRO [308](#)
Modifications, technical, see For Your Own Safety [8](#)
Monitor, see Control Display [47](#)
Mounting of child restraint systems [125](#)
MP3 player, see Owner's Manual for Navigation, Entertainment, Communication [6](#)
M Sport differential, active [215](#)
Multifunction hook [297](#)
Multifunction steering wheel, buttons [32](#)
Multimedia, see Owner's Manual for Navigation, Entertainment and Communication [6](#)

N

Navigation data, trip computer [152](#)
Navigation, see Owner's Manual for Navigation, Entertainment and Communication [6](#)
Neck restraints, front, see Head restraints front [115](#)
Neck restraints, rear, see Head restraints rear [117](#)
Net, cargo area [298](#)

Neutral cleaner, see Light-alloy wheels, care [373](#)
 Notifications [66](#)
 No-touch opening and closing of the trunk lid [95](#)
 Nylon rope for tow-starting/towing [369](#)

O

OBD Onboard Diagnosis [358](#)
 OBD, see OBD Onboard Diagnosis [358](#)
 Obstacle marking, rearview camera [245](#)
 Obstacle marking, Surround View [255](#)
 Octane number, see Gasoline quality [351](#)
 Odometer, see Trip data [166](#)
 Oil, adding [352](#)
 Oil change [354](#)
 Oil filler neck [352](#)
 Oil level, checking electronically [352](#)
 Oil service interval, see Service notifications [163](#)
 Oil types to add, engine [353](#)
 Old battery [362](#)
 Onboard literature, printed [14](#)
 Onboard vehicle tool kit [359](#)
 On-call service, see BMW Accident Assistance [365](#)
 On-call service, see BMW Roadside Assistance [365](#)
 Opening and closing [82](#)
 Opening with the Key Card [87](#)
 Opening with the smartphone, see BMW Digital Key [88](#)
 Operating concept, iDrive [44](#)
 Operating condition of the vehicle [41](#)
 Operation via voice [52](#)
 Optional equipment, see Vehicle equipment [7](#)
 Outside air, see Automatic Recirculating Air Control [273](#)
 Outside temperature [162](#)
 Overheating of the engine, see Engine temperature [161](#)
 Overwintering, see Long-term vehicle storage [374](#)
 Owner's Manual, printed [14](#)
 Owner's Manual via voice operation, BMW Intelligent Personal Assistant [54](#)

P

Paint, car care [372](#)
 Pair device [73](#)
 Pairing, mobile devices, see Connections [73](#)
 Panic alarm, see Panic mode [104](#)
 Panic mode [104](#)
 Panorama View [259](#)
 Park Distance Control PDC [240](#)
 Parking aid, see PDC [240](#)
 Parking assistance systems [239](#)
 Parking assistant [247](#)
 Parking Assistant, driving out of parking space [251](#)
 Parking Assistant for driving out of parking space [251](#)
 Parking assistant Plus, see Surround View [254](#)
 Parking Assistant, see Automatic Parking Assistant [247](#)
 Parking, Automatic Hold, see Parking brake [135](#)
 Parking brake [135](#)
 Parking lights [172](#)
 Parts and accessories [8](#)
 Passenger's side exterior mirror, tilt down, see Automatic Curb Monitor [119](#)
 Pathway lighting [173](#)
 Pathway lighting, switching on [85](#)
 Pathway lines, rearview camera [245](#)
 Payload, technical data [377](#)
 PDC Park Distance Control [240](#)
 Pedestrian Warning with braking function [193](#)
 Performance Control [265](#)
 Personal Assistant [52](#)
 Personal data, deleting [68](#)
 Personal profile, see Driver profiles [69](#)
 Personal settings [68](#)
 Phone, connecting [73](#)
 Physical units, see Set units of measurement [64](#)
 Plastic parts, care [374](#)
 Pop-ups, control display [65](#)
 Possible gestures, gesture control [57](#)
 PostCrash - iBrake [210](#)
 Power Display, instrument cluster [160](#)
 Power failure [361](#)
 Power gauge, see Sport displays [167](#)
 Power Meter, see Power Display [160](#)

- Power windows [105](#)
Pre-conditioning [279](#)
Pressure test tire, see Tire Pressure Monitor [331](#)
Pressure, tires [316](#)
Pre-ventilation [277](#)
Printed onboard literature [14](#)
Profiles, see Driver profiles [69](#)
Programmable memory buttons, iDrive [46](#)
Protective function, glass sunroof, see Jam protection system [108](#)
Protective function, windows, see Jam protection system [106](#)
Push-and-turn reel, see Controller [48](#)
- Q**
- Queuing Assistant, see Assisted Driving Plus [234](#)
- R**
- Racing track [306](#)
Radar sensors, see Sensors of the vehicle [37](#)
Radiator fluid [354](#)
Radio, see Owner's Manual for Navigation, Entertainment and Communication [6](#)
Rain sensor [140](#)
Rear automatic climate control [276](#)
Rear automatic climate control, lock control elements [277](#)
Rear-end collision preparation [205](#)
Rear-end collision warning, see Rear-end collision preparation [205](#)
Rear lights, replacing, see Lights and bulbs [360](#)
Rear seat backrests, folding down [298](#)
Rearview camera, see Surround View [254](#)
Rearview camera, without Surround View [244](#)
Rear-view mirrors, exterior [118](#)
Rear-view mirrors, interior [120](#)
Rear window defroster [269](#), [274](#)
Recirculated-air filter, see Microfilter/activated-charcoal filter [275](#)
Recirculated-air mode [268](#), [273](#)
Recommended tire brands [325](#)
Reduced drive power, see Heavily discharged high-voltage battery [160](#)
Refueling [314](#)
Remote 3D View [261](#)
Remote control for audio, see Owner's Handbook for Navigation, Entertainment, Communication [6](#)
Remote control, see Vehicle key [82](#)
Remote control, universal [282](#)
Remote Engine Start, see Stationary climate control [279](#)
Remote services, app, see Owner's Handbook for Navigation, Entertainment, Communication [6](#)
Remote Software Upgrade [59](#)
Renewal, wheels and tires [324](#)
Replacement, wheels and tires [324](#)
Replacing bulbs, see Lights and bulbs [360](#)
Replacing light diodes, see Lights and bulbs [360](#)
Replacing parts [359](#)
Replacing the battery, vehicle key [85](#)
Reporting safety malfunctions [13](#)
RES CNCL button, Active Cruise Control ACC [220](#)
RES CNCL button, cruise control [218](#)
Reserve warning, see Range [162](#)
Reset settings, vehicle [65](#)
Reset, Tire Pressure Monitor [333](#)
Reset, vehicle data [65](#)
Reset, vehicle settings [65](#)
Restricted Driving, see BMW Digital Key [88](#)
RESUME button, Active Cruise Control [220](#)
RESUME button, cruise control [218](#)
Retreaded tires [325](#)
Reversing Assistant [252](#)
Roadside parking lights [172](#)
Rolling code hand-held transmitter [283](#)
RON, gasoline quality [351](#)
Roofliner [36](#)
Roof-mounted luggage rack [305](#)
Rope for tow-starting/towing [369](#)
Route, navigation, see Owner's Handbook for Navigation, Entertainment, Communication [6](#)
RSC Runflat System, see Runflat tire [326](#)
RTTI, see Owner's Handbook for Navigation, Entertainment, Communication [6](#)

Rubber components, care [373](#)

Run-flat tire [326](#)

S

Safe braking [304](#)

Safe Share function, see BMW Digital Key [88](#)

Safety belt reminder for driver's seat and front passenger seat [114](#)

Safety belt reminder for the rear seats [114](#)

Safety belts [112](#)

Safety belts, care [374](#)

Safety locks, doors, and windows [129](#)

Safety package, see Active Protection [209](#)

Safety switch, windows [106](#)

Safety systems, see Airbags [179](#)

Safety systems, see Intelligent Safety [183](#)

Saving fuel [307](#)

Screen Mirroring, connection [78](#)

Screen, see Control Display [47](#)

Sealing compound, see Tire repair set [327](#)

Seat heating [122](#)

Seat heating, climate control rules [122](#)

Seating position for children [124](#)

Seats and head restraints [109](#)

Seats, front [109](#)

Securing, cargo [297](#)

Selection list in the instrument cluster [165](#)

Selector lever, Steptronic transmission [142](#)

Self-supporting tires, see Run-flat tires [326](#)

Sensors, care [374](#)

Sensors of the vehicle [37](#)

Service and warranty [9](#)

Service Center, see BMW Accident Assistance [365](#)

Service Center, see BMW Roadside Assistance [365](#)

Service notifications [163](#)

Service notifications, see Condition Based Service CBS [357](#)

Services, ConnectedDrive, see Owner's Manual for Navigation, Entertainment and Communication [6](#)

SET button, Active Cruise Control [220](#)

SET button, cruise control [218](#)

Set clock [63](#)

Set day, see Date [63](#)

Set speed, see Active Cruise Control with Stop&Go function [220](#)

Set system language, see Language [64](#)

Set time, see Time [63](#)

Setting, Control Display [65](#)

Settings, general [63](#)

Settings, locking/unlocking [102](#)

Settings, seats and head restraints [109](#)

Setup Wizard [69](#)

Shift lights [160](#)

Shift paddles on the steering wheel [142](#)

Shift point indicator, tachometer [160](#)

Side airbag [179](#)

Side collision mitigation [202](#)

Side parking aid, Surround View [255](#)

Side parking aid without Surround View [243](#)

Side protection aid, Surround View, see Side parking aid [255](#)

Side protection aid without Surround View, see Side parking aid [243](#)

Signaling, horn [32](#)

Signals when unlocking, see Confirmation signals from the vehicle [102](#)

Sitting safely [109](#)

Sleep mode, see Operating condition of the vehicle [41](#)

Slide/tilt glass roof, see Glass sunroof [106](#)

Slipperiness, see Outside temperature [162](#)

Slippery road, see Outside temperature [162](#)

Smallest turning circle, vehicle [376](#)

Smartphone, connecting [73](#)

Smartphone Integration, Android Auto preparation [79](#)

Smartphone Integration, Apple CarPlay preparation [79](#)

Smartphone, see Owner's Manual for Navigation, Entertainment and Communication [6](#)

Smartphone, using via voice control [55](#)

Smoker's package [285](#)

SMS, see Short messages, see Owner's Handbook for Navigation, Entertainment, Communication [6](#)

Socket for OBD Onboard Diagnosis [358](#)

Sockets, electrical devices [286](#)

- Software Update, see Remote Software Upgrade 59
- Software Upgrade, see Remote Software Upgrade 59
- SOS button, see Intelligent emergency call 366
- Sound output, see Owner's Handbook for Navigation, Entertainment, Communication 6
- Spare tire, see Emergency wheel 345
- Speech recognition 52
- Speed Limit Assist 228
- Speed Limit Assistant 228
- Speed Limit Device, Speed Limiter 216
- Speed limit display, see Speed Limit Info 164
- Speed Limit Info 164
- Speed warning 65
- Sport chassis/suspension, see Adaptive M chassis/suspension 265
- Sport displays 167
- SPORT INDIVIDUAL, see Driving Dynamics Control 133
- SPORT PLUS, see Driving Dynamics Control 133
- Sport program, Steptronic transmission 142
- SPORT, see Driving Dynamics Control 133
- Sport steering, variable 215
- Stability control systems 212
- Standard equipment, see Vehicle equipment 7
- Standby, see Operating condition of the vehicle 41
- Start/stop, automatic function 130
- Start/Stop button 130
- Starting aid terminals 367
- Starting, see Drive-ready state 42
- Starting the engine, see Drive-ready state 42
- Starting the engine with the Key Card 87
- Stationary climate control via Remote Engine Start 279
- Stations, AM/FM, see Owner's Handbook for Navigation, Entertainment, Communication 6
- Status control display, tires 333
- Status information, iDrive 45
- Status of Owner's Manual 7
- Status, vehicle 168
- Steering and Lane Control Assistant 230
- Steering Assistant, see Steering and Lane Control Assistant 230
- Steering column adjustment 120
- Steering wheel, adjusting 120
- Steering wheel, buttons 32
- Steering wheel heating 120
- Steering wheel heating, climate control rules 122
- Steptronic Sport transmission, see Steptronic transmission 142
- Steptronic transmission 142
- Stopping the engine, see Drive-ready state 42
- Storage compartment, cargo area 298
- Storage compartment, center console 293
- Storage compartments 292
- Storage compartments, locations 292
- Storage, tires 326
- Store Mirror position, see Memory function 121
- Store seat position, see Memory function 121
- Store steering wheel position, see Memory function 121
- Storing the vehicle 374
- Stowing, cargo 297
- Straps for cargo, see Lashing eyes in the cargo area 297
- Suitable devices 74
- Suitable mobile phones 74
- Summer tires, tread 323
- Sun visor 285
- Sun visor, sliding 285
- Supplementary Owner's Manuals 14
- Surround View 254
- Surround View, gesture control 57
- Suspension settings, see Driving Dynamics Control 133
- Switches, see Dashboard 32
- Switch for driving dynamics, see Driving Dynamics Control 133
- Symbols and displays 7
- SYNC program, automatic climate control 274
- System settings, see General settings 63

T

- Tachometer 159
- Tail lights, replacing, see Lights and bulbs 360
- Taking the vehicle out of service 374
- Tank capacity 378

- Technical changes, see For Your Own Safety [8](#)
- Technical data [376](#)
- Telephone, see Owner's Manual for Navigation, Entertainment and Communication [6](#)
- Telephone, selection list in the instrument cluster [165](#)
- Teleservices, see Owner's Handbook for Navigation, Entertainment, Communication [6](#)
- Temperature, automatic climate control [267](#), [271](#)
- Temperature display electric motor, see Sport displays [167](#)
- Temperature display, see outside temperature [162](#)
- Temperature, engine oil [161](#)
- Theft alarm system, see Alarm system [103](#)
- Thigh support [112](#)
- Tilt alarm sensor [104](#)
- Tilt, backrest [111](#)
- Tilt down, passenger's side exterior mirror, see Automatic Curb Monitor [119](#)
- Time [63](#)
- Time of arrival, trip computer [152](#)
- Time of day, see Time [63](#)
- Time setting, automatic [63](#)
- Tire brands, recommended [325](#)
- Tire chains [331](#)
- Tire change [324](#)
- Tire damage [323](#)
- Tire identification marks [321](#)
- Tire inflation pressure [316](#)
- Tire inflation pressure monitoring, see TPM [338](#)
- Tire inflation pressure monitor TPM [338](#)
- Tire marking [321](#)
- Tire pressure [316](#)
- Tire Pressure Monitor [331](#)
- Tire Pressure Monitor, reset [333](#)
- Tire repair set [327](#)
- Tires and wheels [316](#)
- Tire sealant, see Tire repair set [327](#)
- Tire settings [332](#)
- Tires, run-flat [326](#)
- Tire tread [323](#)
- Title, gesture control [57](#)
- Tone, see Owner's Manual for Navigation, Entertainment and Communication [6](#)
- Tools [359](#)
- Top View, see Surround View [254](#)
- Torque indicator electric motor, see Sport displays [167](#)
- Torque indicator, see Sport displays [167](#)
- Touchpad, Controller [50](#)
- Tow bar [369](#)
- Tow fitting [370](#)
- Towing [368](#)
- Tow rope [369](#)
- Tow-starting [368](#)
- TPM Flat Tire Monitor [338](#)
- Traction control [214](#)
- TRACTION, driving dynamics [214](#)
- Traffic bulletins, see Owner's Handbook for Navigation, Entertainment, Communication [6](#)
- Traffic Jam Assistant, see Assisted Driving Plus [234](#)
- Traffic jam assistant, see Steering and Lane Control Assistant [230](#)
- Transmission lock, electronic unlocking [146](#)
- Transmission, see Steptronic transmission [142](#)
- Transporting children safely [124](#)
- Tread, tires [323](#)
- Trip computer, see Trip data [166](#)
- Trip data [166](#)
- Triple turn signal activation [139](#)
- Trip odometer, see Trip data [166](#)
- Trunk, emergency unlocking [100](#)
- Trunk lid [98](#)
- Trunk lid, emergency unlocking [100](#)
- Trunk lid, opening and closing with no-touch activation [95](#)
- Trunk lid, see Trunk lid [98](#)
- Trunk lid, vehicle key [84](#)
- Trunk, see Cargo area [296](#)
- Turning circle lines, rearview camera [245](#)
- Turning circle line, Surround View [255](#)
- Turning circle, vehicle [376](#)
- Turn signal, indicator light [157](#)
- Turn signal, replacing bulbs, see Lights and bulbs [360](#)
- Turn signals, high beams, headlight flasher [138](#)

U

Ultrasonic sensors, see Sensors of the vehicle [37](#)
Unintentional alarm, avoiding [104](#)
Units of measurement [64](#)
Units, see Set units of measurement [64](#)
Universal remote control [282](#)
Unlock button, Steptronic transmission [142](#)
Unlocking, automatic [102](#)
Unlocking, see Opening and Closing [82](#)
Unlocking, settings [102](#)
Unlocking, vehicle key [83](#)
Unwarranted alarm, see Avoiding unintentional alarms [104](#)
Updates made after the editorial deadline [7](#)
Upgrade, see Remote Software Upgrade [59](#)
Upholstery material care [373](#)
Upper retaining strap, top tether [128](#)
USB connection [80](#)
USB port, position in vehicle [288](#)
Used battery, disposing of [362](#)
Use, intended [8](#)

V

Valet parking mode [100](#)
Vanity mirror [285](#)
Variable sport steering [215](#)
Vehicle battery [360](#)
Vehicle breakdown, see Breakdown assistance [364](#)
Vehicle, breaking in [302](#)
Vehicle care [372](#)
Vehicle care products [372](#)
Vehicle data, reset [65](#)
Vehicle equipment [7](#)
Vehicle identification number [12](#)
Vehicle key [82](#)
Vehicle key, additional [85](#)
Vehicle key, integrated key [91](#)
Vehicle key, loss [85](#)
Vehicle key, malfunction [86](#)
Vehicle key, replacing the battery [85](#)
Vehicle paint, care [372](#)
Vehicle status [168](#)

Vehicle storage [374](#)
Vehicle washing [371](#)
Ventilation [275](#)
Ventilation, see Pre-ventilation [277](#)
Venting, see Ventilation [275](#)
Vent, see Ventilation [275](#)
Version Software, see Remote Software Upgrade [59](#)
Video recording, see BMW Drive Recorder [207](#)
Video, see Owner's Manual for Navigation, Entertainment and Communication [6](#)
VIN, see Vehicle identification number [12](#)
Voice command response [52](#)
Voice control [52](#)
Voice control, gesture control [57](#)
Voice control, see BMW Intelligent Personal Assistant [52](#)
Voice control system [52](#)
Volume, gesture control [57](#)

W

Wake word [53](#)
Warning against cross traffic [262](#)
Warning function, rear-end collision [205](#)
Warning light in the exterior mirror, see Active Blind Spot Detection [199](#)
Warning light in the exterior mirror, see Cross traffic warning [262](#)
Warning lights [154](#)
Warning messages, see Check Control [153](#)
Warning triangle [364](#)
Warranty [8](#)
Warranty Booklet [8](#)
Washer fluid [355](#)
Washer system [139](#)
Washing the vehicle [371](#)
Washing, vehicle [371](#)
Wash view, Surround View [255](#)
Water on roads [303](#)
Water, see Condensation water under the parked vehicle [305](#)
Website, see Internet [6](#)
Weights [377](#)
Welcome light during unlocking [83](#)
Welcome lights [173](#)

Welcome screen, driver profiles [69](#)
Wheel base, vehicle [376](#)
Wheels and tires [316](#)
Wheels and tires, exchange [324](#)
Widgets, iDrive [45](#)
Widgets, instrument cluster [150](#), [151](#)
Width, vehicle [376](#)
Wi-Fi connection [77](#)
WiFi connection, see WLAN connection [77](#)
Wi-Fi hotspot [77](#)
Window, defrosting [269](#), [274](#)
Windows, powered [105](#)
Windshield, defrosting [269](#), [274](#)
Windshield washer fluid, see Washer fluid [355](#)
Windshield wiper, see Wiper system [139](#)
Winter storage, see Long-term vehicle storage [374](#)
Winter tires [325](#)
Winter tires, tread [323](#)
Wiper blades, replacing [359](#)
Wiper fluid, see Washer fluid [355](#)
Wiper, fold-away position [141](#)
Wiper, see Washer/wiper system [139](#)
Wiper system [139](#)
Wireless charging, smartphone, see Wireless charging tray [289](#)
Wireless charging tray for smartphones [289](#)
WLAN connection [77](#)
Wood parts, care [373](#)
Wordmatch principle, see Entry comparison [45](#)
Wrench, see Onboard vehicle tool kit [359](#)

X

xDrive [214](#)



01405A38F56 ue

California Proposition 65 Warning

For vehicles sold in California:

California Proposition 65 Warning



WARNING

Operating, servicing and maintaining a passenger vehicle or off-highway motor vehicle can expose you to chemicals including engine exhaust, carbon monoxide, phthalates, and lead, which are known to the State of California to cause cancer and birth defects or other reproductive harm. To minimize exposure, avoid breathing exhaust, do not idle the engine except as necessary, service your vehicle in a well-ventilated area and wear gloves or wash your hands frequently when servicing your vehicle. For more information go to www.P65Warnings.ca.gov/passenger-vehicle.



The Ultimate
Driving Machine®



BMW DRIVER'S GUIDE APP.

Your customized information about the vehicle in an app.
Optimized for smartphones & tablets. Can be used offline.



Download on the
App Store



GET IT ON
Google Play



01405A38F56 ue

Online Edition for Part no. 01405A38F56 - VI/21