

# 2019 FORD TRANSIT CONNECT Owner's Manual





The information contained in this publication was correct at the time of going to print. In the interest of continuous development, we reserve the right to change specifications, design or equipment at any time without notice or obligation. No part of this publication may be reproduced, transmitted, stored in a retrieval system or translated into any language in any form by any means without our written permission. Errors and omissions excepted.

© Ford Motor Company 2018

All rights reserved.

Part Number: CG3739en 201804 20180409084652

## California Proposition 65



**WARNING:** Operating, servicing and maintaining a passenger vehicle or off-highway motor vehicle can expose you to chemicals including engine exhaust, carbon monoxide, phthalates, and lead, which are known to the State of California to cause cancer and birth defects or other reproductive harm. To minimize exposure, avoid breathing exhaust, do not idle the engine except as necessary, service your vehicle in a well-ventilated area and wear gloves or wash your hands frequently when servicing your vehicle. For more information go to [www.P65Warnings.ca.gov/passenger-vehicle](http://www.P65Warnings.ca.gov/passenger-vehicle).



**WARNING:** Battery posts, terminals and related accessories contain lead and lead compounds, chemicals known to the State of California to cause cancer and reproductive harm.  
**Wash your hands after handling.**



# Table of Contents

---

## Introduction

About This Manual .....	7
Symbols Glossary .....	7
Data Recording .....	9
Perchlorate .....	13
Ford Credit .....	13
Replacement Parts Recommendation .....	13
Special Notices .....	14
Mobile Communications Equipment .....	15
Export Unique Options .....	15

## Environment

Protecting the Environment .....	16
----------------------------------	----

## At a Glance

Instrument Panel Overview .....	17
---------------------------------	----

## Child Safety

General Information .....	18
Installing Child Restraints .....	19
Booster Seats .....	26
Child Restraint Positioning .....	28
Child Safety Locks .....	30

## Seatbelts

Principle of Operation .....	32
Fastening the Seatbelts .....	33
Seatbelt Height Adjustment .....	35
Seatbelt Warning Lamp and Indicator Chime .....	36
Seatbelt Reminder .....	36
Child Restraint and Seatbelt Maintenance .....	38
Seatbelt Extension .....	38

## Personal Safety System™

Personal Safety System™ .....	39
-------------------------------	----

## Supplementary Restraints System

Principle of Operation .....	40
Driver and Passenger Airbags .....	41
Front Passenger Sensing System .....	42
Side Airbags .....	45
Driver Knee Airbag .....	46
Safety Canopy™ .....	46
Crash Sensors and Airbag Indicator .....	47
Airbag Disposal .....	48

## Automatic Crash Notification System

911 Assist .....	49
------------------	----

## Keys and Remote Controls

General Information on Radio Frequencies .....	51
Remote Control - Vehicles With: Keyless Entry and Push Button Start .....	51
Remote Control - Vehicles With: Remote Flip Key .....	54
Replacing a Lost Key or Remote Control .....	55
Passive Key Backup Position .....	55

## MyKey™

Principle of Operation .....	56
MyKey Settings .....	56
Creating a MyKey - Vehicles Without: Push Button Start .....	57
Creating a MyKey - Vehicles With: Push Button Start .....	57
Programming a MyKey .....	58
Clearing All MyKeys .....	60
Checking MyKey System Status .....	60
Using MyKey With Remote Start Systems .....	61
MyKey Troubleshooting - Vehicles Without: Push Button Start .....	61
MyKey Troubleshooting - Vehicles With: Push Button Start .....	61

# Table of Contents

---

## Doors and Locks

Locking and Unlocking .....	63
Sliding Door .....	66
Keyless Entry .....	67

## Liftgate

Manual Liftgate .....	69
-----------------------	----

## Security

Passive Anti-Theft System .....	70
Anti-Theft Alarm .....	72

## Steering Wheel

Adjusting the Steering Wheel .....	74
------------------------------------	----

## Wipers and Washers

Windshield Wipers .....	75
Autowipers .....	75
Windshield Washers .....	76
Rear Window Wiper and Washers .....	77

## Lighting

General Information .....	78
Lighting Control .....	78
Autolamps .....	79
Instrument Lighting Dimmer .....	79
Headlamp Exit Delay .....	80
Automatic High Beam Control .....	80
Front Fog Lamps .....	81
Cornering Lamps .....	81
Direction Indicators .....	82
Interior Lamps .....	82

## Windows and Mirrors

Power Windows - Vehicles With: Rear Power Windows .....	83
Power Windows - Vehicles With: One-Touch Open Driver Window .....	84
Global Opening .....	84
Exterior Mirrors .....	84

Interior Mirror - Vehicles Without: Auto-Dimming Interior Mirror .....	85
Interior Mirror - Vehicles With: Auto-Dimming Interior Mirror .....	85
Sun Shades .....	85

## Instrument Cluster

Gauges .....	87
Warning Lamps and Indicators .....	88
Audible Warnings and Indicators .....	90

## Information Displays

General Information .....	92
Clock .....	94
Trip Computer .....	94
Personalized Settings .....	94
Information Messages .....	94

## Climate Control

Manual Climate Control .....	108
Automatic Climate Control .....	109
Hints on Controlling the Interior Climate - Vehicles With: Automatic Temperature Control .....	111
Hints on Controlling the Interior Climate - Vehicles With: Manual Temperature Control .....	112
Rear Passenger Climate Controls .....	112
Heated Windshield .....	113
Heated Rear Window .....	113
Heated Exterior Mirrors .....	113
Cabin Air Filter .....	113

## Seats

Sitting in the Correct Position .....	115
Head Restraints .....	115
Manual Seats .....	117
Power Seats .....	119
Rear Seats - Short Wheelbase .....	120

# Table of Contents

---

Rear Seats - Long Wheelbase, Vehicles With: Second Row Dual Captain Chairs .....	124	Fuel Consumption .....	157
Rear Seats - Long Wheelbase, Vehicles With: 60/40 Split Second Row Seating .....	127	<b>Engine Emission Control</b>	
Heated Seats .....	130	Emission Law .....	158
<b>Auxiliary Power Points</b>		Catalytic Converter .....	159
Auxiliary Power Points .....	131	Selective Catalytic Reductant System .....	160
Cigar Lighter .....	131	Diesel Particulate Filter .....	163
Wireless Accessory Charging .....	132	<b>Transmission</b>	
<b>Storage Compartments</b>		Automatic Transmission - 6-Speed Automatic Transmission .....	169
Cup Holders .....	133	Automatic Transmission - 8-Speed Automatic Transmission .....	171
Overhead Console .....	133	<b>Brakes</b>	
<b>Starting and Stopping the Engine</b>		General Information .....	173
General Information .....	134	Hints on Driving With Anti-Lock Brakes .....	174
Ignition Switch .....	134	Parking Brake .....	174
Push Button Ignition Switch .....	135	Hill Start Assist .....	174
Starting a Gasoline Engine .....	137	<b>Traction Control</b>	
Starting a Flex Fuel Engine .....	140	Principle of Operation .....	176
Starting a Diesel Engine .....	142	Using Traction Control .....	176
Switching Off the Engine .....	144	<b>Stability Control</b>	
Engine Block Heater .....	144	Principle of Operation .....	177
<b>Unique Driving Characteristics</b>		Using Stability Control .....	178
Auto-Start-Stop .....	146	<b>Parking Aids</b>	
<b>Fuel and Refueling</b>		Principle of Operation .....	179
Safety Precautions .....	148	Rear Parking Aid .....	179
Fuel Quality - Diesel .....	148	Front Parking Aid .....	181
Fuel Quality - Gasoline .....	151	Side Sensing System .....	183
Fuel Quality - E85 .....	152	Active Park Assist .....	184
Fuel Filler Funnel Location .....	153	Rear View Camera .....	192
Running Out of Fuel .....	153	<b>Cruise Control</b>	
Refueling .....	154	Principle of Operation .....	195

# Table of Contents

---

Using Cruise Control .....	195
Using Adaptive Cruise Control .....	196

## Driving Aids

Speed Limiter .....	202
Driver Alert .....	203
Lane Keeping System .....	205
Blind Spot Information System .....	209
Cross Traffic Alert .....	211
Eco Mode .....	213
Steering .....	215
Pre-Collision Assist .....	215

## Load Carrying

Luggage Anchor Points .....	221
Rear Under Floor Storage .....	221
Cargo Nets .....	222
Roof Racks and Load Carriers .....	224
Load Limit .....	225

## Towing

Towing a Trailer .....	230
Trailer Sway Control .....	231
Recommended Towing Weights .....	231
Essential Towing Checks .....	233
Transporting the Vehicle .....	236
Towing the Vehicle on Four Wheels .....	237

## Driving Hints

Breaking-In .....	238
Reduced Engine Performance .....	238
Economical Driving .....	238
Cold Weather Precautions .....	239
Driving Through Water .....	239
Floor Mats .....	239

## Roadside Emergencies

Roadside Assistance .....	241
Hazard Flashers .....	242

Fuel Shutoff .....	242
Jump Starting the Vehicle .....	243
Post-Crash Alert System .....	245
Towing Points .....	245

## Customer Assistance

Getting the Services You Need .....	247
In California (U.S. Only) .....	248
The Better Business Bureau (BBB) Auto Line Program (U.S. Only) .....	249
Utilizing the Mediation/Arbitration Program (Canada Only) .....	250
Getting Assistance Outside the U.S. and Canada .....	250
Ordering Additional Owner's Literature .....	252
Reporting Safety Defects (U.S. Only) .....	252
Reporting Safety Defects (Canada Only) .....	252

## Fuses

Fuse Box Locations .....	254
Fuse Specification Chart .....	254
Changing a Fuse .....	260

## Maintenance

General Information .....	261
Opening and Closing the Hood .....	261
Under Hood Overview - 1.5L Duratorq-TDCi Diesel .....	262
Under Hood Overview - 2.0L Duratec-HE (M14)/2.0L Flex Fuel .....	263
Under Hood Overview - 2.5L .....	264
Engine Oil Dipstick - 1.5L Duratorq-TDCi Diesel .....	265
Engine Oil Dipstick - 2.0L Duratec-HE (M14)/2.0L Flex Fuel/2.5L .....	266
Engine Oil Check .....	266
Oil Change Indicator Reset .....	267
Engine Cooling Fan - Gasoline .....	267
Engine Cooling Fan - Diesel .....	268



# Table of Contents

Engine Coolant Check .....	268	Tire Care .....	301
Automatic Transmission Fluid Check .....	272	Using Winter Tires .....	315
Brake Fluid Check .....	272	Using Snow Chains .....	315
Washer Fluid Check .....	273	Tire Pressure Monitoring System .....	316
Changing the 12V Battery .....	273	Changing a Road Wheel .....	320
Checking the Wiper Blades .....	275	Tire Pressures .....	324
Changing the Front Wiper Blades .....	275	Lug Nuts .....	325
Changing the Rear Wiper Blades - Vehicles With: Manual Liftgate .....	275	<b>Capacities and Specifications</b>	
Changing the Rear Wiper Blades - Vehicles With: Rear Cargo Doors .....	276	Engine Specifications - 1.5L Duratorq-TDCi Diesel .....	327
Adjusting the Headlamps .....	276	Engine Specifications - 2.0L Duratec-HE (M14)/2.0L Flex Fuel .....	328
Changing a Bulb .....	278	Engine Specifications - 2.5L .....	329
Changing the Engine Air Filter - 2.0L Duratec-HE (M14)/2.0L Flex Fuel, 1.5L Duratorq-TDCi Diesel .....	283	Motorcraft Parts - 1.5L Duratorq-TDCi Diesel .....	330
Changing the Engine Air Filter - 2.5L .....	283	Motorcraft Parts - 2.0L Duratec-HE (M14)/2.0L Flex Fuel .....	331
Drive Belt Routing - 1.5L Duratorq-TDCi Diesel .....	284	Motorcraft Parts - 2.5L .....	332
Drive Belt Routing - 2.0L Duratec-HE (M14)/2.0L Flex Fuel .....	284	Vehicle Identification Number .....	333
Drive Belt Routing - 2.5L .....	285	Vehicle Certification Label .....	334
<b>Vehicle Care</b>		Transmission Code Designation - 6-Speed Automatic Transmission .....	334
Cleaning Products .....	286	Transmission Code Designation - 8-Speed Automatic Transmission .....	335
Cleaning the Exterior .....	287	Capacities and Specifications - 1.5L Duratorq-TDCi Diesel .....	335
Waxing .....	288	Capacities and Specifications - 2.0L Duratec-HE (M14)/2.0L Flex Fuel .....	340
Cleaning the Windows and Wiper Blades .....	289	Capacities and Specifications - 2.5L .....	345
Cleaning the Interior .....	289	Bulb Specification Chart .....	350
Cleaning the Instrument Panel and Instrument Cluster Lens .....	290	<b>Audio System</b>	
Cleaning Leather Seats .....	291	General Information .....	352
Repairing Minor Paint Damage .....	292	Audio Unit - Vehicles Without: SYNC 3 .....	353
Cleaning the Wheels .....	292	Audio Unit - Vehicles With: SYNC 3 .....	356
Vehicle Storage .....	292	AM/FM Radio - Vehicles Without: SYNC 3 .....	358
<b>Wheels and Tires</b>			
General Information .....	295		
Tire Sealant and Inflator Kit .....	296		

# Table of Contents

---

Audio Unit Clock and Date Displays - Vehicles Without: SYNC 3 .....	358	Declaration of Conformity - Vehicles Without: SYNC 3 .....	461
Connecting a Bluetooth Device - Vehicles Without: SYNC 3 .....	358	Declaration of Conformity - Vehicles With: SYNC 3 .....	462
Satellite Radio .....	359	Declaration of Conformity - Vehicles With: Wireless Accessory Charging .....	462
Streaming Bluetooth Audio - Vehicles Without: SYNC 3 .....	361	Type Approvals .....	464
Playing Media From a USB Device - Vehicles Without: SYNC 3 .....	361		
USB Port - Vehicles Without: SYNC 3 .....	362		
Using Voice Recognition .....	362		

## **SYNC™ 3**

General Information .....	363
Home Screen .....	372
Using Voice Recognition .....	372
Entertainment .....	377
Phone .....	379
Navigation .....	381
Apps .....	385
Settings .....	386
SYNC™ 3 Troubleshooting .....	400

## **Accessories**

Accessories .....	412
-------------------	-----

## **Ford Protect**

Ford Protect .....	414
--------------------	-----

## **Scheduled Maintenance**

General Maintenance Information .....	416
Normal Scheduled Maintenance .....	419
Special Operating Conditions Scheduled Maintenance .....	422
Scheduled Maintenance Record .....	424

## **Appendices**

Electromagnetic Compatibility .....	434
End User License Agreement .....	436

# Introduction

## ABOUT THIS MANUAL

Thank you for choosing Ford. We recommend that you take some time to get to know your vehicle by reading this manual. The more that you know about your vehicle, the greater the safety and pleasure you will get from driving it.



**WARNING:** Driving while distracted can result in loss of vehicle control, crash and injury. We strongly recommend that you use extreme caution when using any device that may take your focus off the road. Your primary responsibility is the safe operation of your vehicle. We recommend against the use of any hand-held device while driving and encourage the use of voice-operated systems when possible. Make sure you are aware of all applicable local laws that may affect the use of electronic devices while driving.

**Note:** This manual describes product features and options available throughout the range of available models, sometimes even before they are generally available. It may describe options not fitted to the vehicle you have purchased.

**Note:** Some of the illustrations in this manual may show features as used in different models, so may appear different to you on your vehicle.

**Note:** Always use and operate your vehicle in line with all applicable laws and regulations.

**Note:** Pass on this manual when selling your vehicle. It is an integral part of your vehicle.

This manual may qualify the location of a component as left-hand side or right-hand side. The side is determined when facing forward in the seat.



E154903

A Right-hand side.

B Left-hand side.

## SYMBOLS GLOSSARY

These are some of the symbols you may see on your vehicle.



Air conditioning system



Air conditioning system lubricant type



Anti-lock braking system



Avoid smoking, flames or sparks



Battery



Battery acid



Brake fluid - non petroleum based



Brake system

# Introduction



Brake system



Flammable



Cabin air filter



Front airbag



Check fuel cap



Front fog lamps



Child safety door lock or unlock



Fuel pump reset



Child seat lower anchor



Fuse compartment



Child seat tether anchor



Hazard flashers



Cruise control



Heated rear window



Do not open when hot



Windshield defrosting system



Engine air filter



Interior luggage compartment release



Engine coolant



Jack



Engine coolant temperature



Keep out of reach of children



Engine oil



Lighting control



Explosive gas



Low tire pressure warning



Fan warning



Maintain correct fluid level



Fasten seatbelt



Note operating instructions

# Introduction



Horn control



Panic alarm



Parking aid



Parking brake



Power steering fluid



Power windows front/rear



Power window lockout



Requires registered technician



Safety alert



See Owner's Manual



See Service Manual



Service engine soon



Passenger airbag activated



Passenger airbag deactivated



Side airbag



Shield the eyes



Stability control



Hill descent control



Trail control



Windshield wiper system



Windshield wash and wipe

## DATA RECORDING



**WARNING:** Do not connect wireless plug-in devices to the data link connector. Unauthorized third parties could gain access to vehicle data and impair the performance of safety related systems. Only allow repair facilities that follow our service and repair instructions to connect their equipment to the data link connector.

We respect your privacy and are committed to protecting it. The information contained in this publication was correct at the time of going to print but as technology rapidly changes, we recommend that you visit the regional Ford website for the latest information.

# Introduction

---

Your vehicle has electronic control units that have data recording functionality and the ability to permanently or temporarily store data. This data could include information on the condition and status of your vehicle, vehicle maintenance requirements, events and malfunctions. The types of data that can be recorded are described in this section. Some of the data recorded is stored in event logs or error logs.

**Note:** *Error logs are reset following a service or repair.*

**Note:** *We may provide information in response to requests from law enforcement, other government authorities and third parties acting with lawful authority or through a legal process. Such information could be used by them in legal proceedings.*

Data recorded includes, for example:

- Operating states of system components, for example fuel level, tire pressure and battery charge level.
- Vehicle and component status, for example wheel speed, deceleration, lateral acceleration and seatbelt status.
- Events or errors in essential systems, for example headlamps and brakes.
- System responses to driving situations, for example airbag deployment and stability control.
- Environmental conditions, for example temperature.

Some of this data, when used in combination with other information, for example an accident report, damage to a vehicle or eyewitness statements, could be associated with a specific person.

## Service Data

Service data recorders in your vehicle are capable of collecting and storing diagnostic information about your vehicle. This potentially includes information about the performance or status of various systems and modules in the vehicle, such as engine, throttle, steering or brake systems. In order to properly diagnose and service your vehicle, Ford Motor Company (Ford of Canada in Canada), and service and repair facilities may access or share among them vehicle diagnostic information received through a direct connection to your vehicle when diagnosing or servicing your vehicle. Additionally, Ford Motor Company (Ford of Canada, in Canada) may, where permitted by law, use vehicle diagnostic information for vehicle improvement or with other information we may have about you, (for example, your contact information), to offer you products or services that may interest you. Data may be provided to our service providers such as part suppliers that may help diagnose malfunctions, and who are similarly obligated to protect data. We retain this data only as long as necessary to perform these functions or to comply with law. We may provide information where required in response to official requests to law enforcement or other government authorities or third parties acting with lawful authority or court order, and such information may be used in legal proceedings. For U.S. only (if equipped), if you choose to use connected apps and services, you consent that certain diagnostic information may also be accessed electronically by Ford Motor Company and Ford authorized service facilities, and that the diagnostic information may be used to provide services to you, personalizing your experience, troubleshoot, and to improve products and services and offer you

# Introduction

---

products and services that may interest you, where permitted by law. For Canada only, for more information, please review the Ford of Canada privacy policy at [www.ford.ca](http://www.ford.ca), including our U.S. data storage and use of service providers in other jurisdictions who may be subject to legal requirements in Canada, the United States and other countries applicable to them, for example, lawful requirements to disclose personal information to governmental authorities in those countries.

## Event Data

This vehicle is equipped with an event data recorder. The main purpose of an event data recorder is to record, in certain crash or near crash-like situations, such as an airbag deployment or hitting a road obstacle; this data will assist in understanding how a vehicle's systems performed. The event data recorder is designed to record data related to vehicle dynamics and safety systems for a short period of time, typically 30 seconds or less.

The event data recorder in this vehicle is designed to record such data as:

- How various systems in your vehicle were operating;
- Whether or not the driver and passenger seatbelts were buckled/fastened;
- How far (if at all) the driver was depressing the accelerator and/or the brake pedal; and
- How fast the vehicle was traveling; and
- Where the driver was positioning the steering wheel.

This data can help provide a better understanding of the circumstances in which crashes and injuries occur.

**Note:** *Event data recorder data is recorded by your vehicle only if a non-trivial crash situation occurs; no data is recorded by the event data recorder under normal driving conditions and no personal data or information (e.g., name, gender, age, and crash location) is recorded. However, parties, such as law enforcement, could combine the event data recorder data with the type of personally identifying data routinely acquired during a crash investigation.*

To read data recorded by an event data recorder, special equipment is required, and access to the vehicle or the event data recorder is needed. In addition to the vehicle manufacturer, other parties, such as law enforcement, that have such special equipment, can read the information if they have access to the vehicle or the event data recorder.

## Comfort, Convenience and Entertainment Data

Your vehicle has electronic control units that have the ability to store data based on your personalized settings. The data is stored locally in the vehicle or on devices that you connect to it, for example, a USB drive or digital music player. You can delete some of this data and also choose whether to share it through the services to which you subscribe. See **Settings** (page 386).

## Comfort and Convenience Data

Data recorded includes, for example:

- Seat and steering wheel position.
- Climate control settings.
- Radio presets.

# Introduction

---

## Entertainment Data

Data recorded includes, for example:

- Music, videos or album art.
- Contacts and corresponding address book entries.
- Navigation destinations.

## Services That We Provide

If you use our services, we collect and use data, for example account information, vehicle location and driving characteristics, that could identify you. We transmit this data through a dedicated, protected connection. We only collect and use data to enable your use of our services to which you have subscribed, with your consent or where permitted by law. For additional information, see the terms and conditions of the services to which you have subscribed.

## Services That Third Parties Provide

We recommend that you review the terms and conditions and data privacy information for any services to which you subscribe. We take no responsibility for services that third parties provide.

## Vehicles With a Modem

The modem has a SIM. The modem periodically sends messages to stay connected to the cell phone network. These messages could include information that identifies your vehicle, the SIM and the electronic serial number of the modem. Cell phone network service providers could have access to additional information, for example cell phone network tower identification.

**Note:** *The modem continues to send this information unless you have all added value services deactivated. Contact the Ford Customer Relationship Center. Refer to the regional Ford website for contact information.*

**Note:** *The service can be unavailable or interrupted for a number of reasons, for example environmental or topographical conditions and data plan coverage.*

## Vehicles With SYNC

### Mobile Device Data

If you connect a mobile device to your vehicle, you can display data from your device on the touchscreen for example, music and album art. You can share your vehicle data with mobile apps on your device through the system. See **Apps** (page 385).

The mobile apps function operates by your connected device sending data to us in the United States. The data is encrypted and includes the vehicle identification number of your vehicle, the SYNC module serial number, odometer, enabled apps, usage statistics and debugging information. We retain it only as long as necessary to provide the service, to troubleshoot, for continuous improvement and to offer you products and services that may be of interest to you according to your preferences and where allowed by law.

If you connect a cell phone to the system, the system creates a profile that links to that cell phone. The cell phone profile enables more mobile features and efficient operation. The profile contains, for example data from your phonebook, read and unread text messages and call history, including history of calls when your cell phone was not connected to the system.



# Introduction

---

If you connect a media device, the system creates and retains a media device index of supported media content. The system also records a short diagnostic log of approximately 10 minutes of all recent system activity.

The cell phone profile, media device index and diagnostic log remain in your vehicle unless you delete them and are generally accessible only in your vehicle when you connect your cell phone or media device. If you no longer plan to use the system or your vehicle, we recommend you use the master reset function to erase the stored information. See **Settings** (page 386).

System data cannot be accessed without special equipment and access to your vehicle's module.

For additional information about our privacy policy, see the regional Ford website.

## PERCHLORATE

Certain components in your vehicle such as airbag modules, seatbelt pretensioners and remote control batteries may contain perchlorate material. Special handling may apply for service or vehicle end of life disposal.

### For more information visit:

Web Address
<a href="http://www.dtsc.ca.gov/hazard-ouswaste/perchlorate">www.dtsc.ca.gov/hazard-ouswaste/perchlorate</a>

## FORD CREDIT

### US Only

Ford Credit offers a full range of financing and lease plans to help you acquire your vehicle. If you have financed or leased your vehicle through Ford Credit, thank you for your business.

We offer a number of convenient ways for you to contact us, and to manage your account.

Call 1-800-727-7000.

For more information about Ford Credit and access to Account Manager, go to [www.ford.com/finance](http://www.ford.com/finance).

## REPLACEMENT PARTS RECOMMENDATION

We have built your vehicle to the highest standards using quality parts. We recommend that you demand the use of genuine Ford and Motorcraft parts whenever your vehicle requires scheduled maintenance or repair. You can clearly identify genuine Ford and Motorcraft parts by looking for the Ford, FoMoCo or Motorcraft branding on the parts or their packaging.

# Introduction

## Scheduled Maintenance and Mechanical Repairs

One of the best ways for you to make sure that your vehicle provides years of service is to have it maintained in line with our recommendations using parts that conform to the specifications detailed in this Owner's Manual. Genuine Ford and Motorcraft parts meet or exceed these specifications.

## Collision Repairs

We hope that you never experience a collision, but accidents do happen. Genuine Ford replacement collision parts meet our stringent requirements for fit, finish, structural integrity, corrosion protection and dent resistance. During vehicle development we validate that these parts deliver the intended level of protection as a whole system. A great way to know for sure you are getting this level of protection is to use genuine Ford replacement collision parts.

## Warranty on Replacement Parts

Genuine Ford and Motorcraft replacement parts are the only replacement parts that benefit from a Ford Warranty. The Ford Warranty may not cover damage caused to your vehicle as a result of failed non-Ford parts. For additional information, refer to the terms and conditions of the Ford Warranty.

## SPECIAL NOTICES

### New Vehicle Limited Warranty

For a detailed description of what is covered and what is not covered by your vehicle's New Vehicle Limited Warranty, see the Warranty Manual that is provided to you along with your Owner's Manual.

## Special Instructions

For your added safety, your vehicle is fitted with sophisticated electronic controls.



**WARNING:** You risk death or serious injury to yourself and others if you do not follow the instruction highlighted by the warning symbol. Failure to follow the specific warnings and instructions could result in personal injury.



**WARNING:** NEVER use a rearward facing child restraint on a seat protected by an ACTIVE AIRBAG in front of it, DEATH or SERIOUS INJURY to the CHILD can occur.

## On Board Diagnostics Data Link Connector



**WARNING:** Do not connect wireless plug-in devices to the data link connector. Unauthorized third parties could gain access to vehicle data and impair the performance of safety related systems. Only allow repair facilities that follow our service and repair instructions to connect their equipment to the data link connector.

Your vehicle has an OBD Data Link Connector (DLC) that is used in conjunction with a diagnostic scan tool for vehicle diagnostics, repairs and reprogramming services. Installing an aftermarket device that uses the DLC during normal driving for purposes such as remote insurance company monitoring, transmission of vehicle data to other devices or entities, or altering the performance of the vehicle, may cause

# Introduction

---

interference with or even damage to vehicle systems. We do not recommend or endorse the use of aftermarket plug-in devices unless approved by Ford. The vehicle Warranty will not cover damage caused by an aftermarket plug-in device.

## MOBILE COMMUNICATIONS EQUIPMENT



**WARNING:** Driving while distracted can result in loss of vehicle control, crash and injury. We strongly recommend that you use extreme caution when using any device that may take your focus off the road. Your primary responsibility is the safe operation of your vehicle. We recommend against the use of any hand-held device while driving and encourage the use of voice-operated systems when possible. Make sure you are aware of all applicable local laws that may affect the use of electronic devices while driving.

Using mobile communications equipment is becoming increasingly important in the conduct of business and personal affairs. However, you must not compromise your own or others' safety when using such equipment. Mobile communications can enhance personal safety and security when appropriately used, particularly in emergency situations. Safety must be paramount when using mobile communications equipment to avoid negating these benefits. Mobile communication equipment includes, but is not limited to, cellular phones, pagers, portable email devices, text messaging devices and portable two-way radios.

## EXPORT UNIQUE OPTIONS

For your particular global region, your vehicle may be equipped with features and options that are different from the features and options that are described in this Owner's Manual. A market unique supplement may be supplied that complements this book. By referring to the market unique supplement, if provided, you can properly identify those features, recommendations and specifications that are unique to your vehicle. This Owner's Manual is written primarily for the U.S. and Canadian Markets. Features or equipment listed as standard may be different on units built for export. **Refer to this Owner's Manual for all other required information and warnings.**

# Environment

---

## **PROTECTING THE ENVIRONMENT**

You should play your part in protecting the environment. Correct vehicle usage and the authorized disposal of waste, cleaning and lubrication materials are significant steps toward this aim.

**For details about Ford Motor Company's sustainability progress and initiatives visit:**

<b>Web Address</b>
<a href="http://www.sustainability.ford.com">www.sustainability.ford.com</a>

# At a Glance

## INSTRUMENT PANEL OVERVIEW

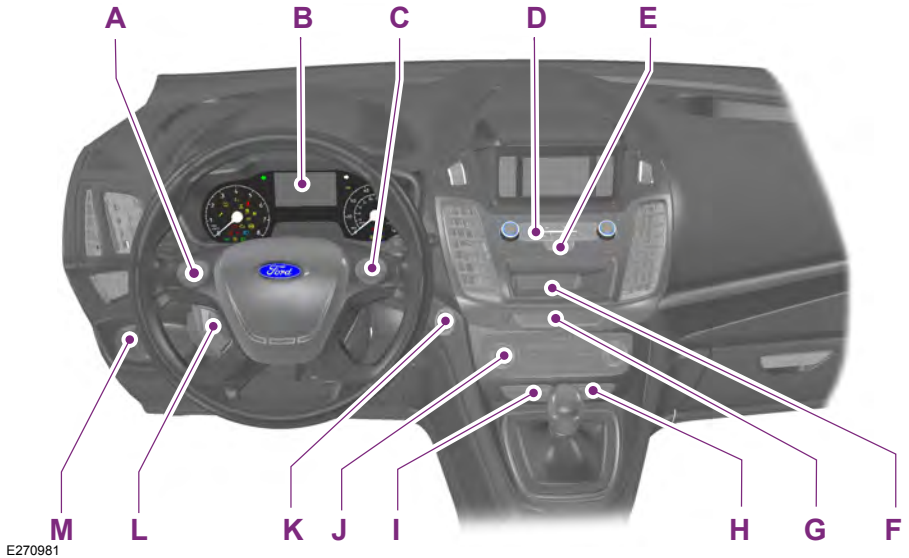

E270981

- A Information display controls. See **General Information** (page 92).
- B Instrument cluster. See **Gauges** (page 87).
- C Audio and voice control buttons.
- D Audio unit. See **Audio System** (page 352).
- E Hazard flasher switch. See **Hazard Flashers** (page 242).
- F Wireless accessory charging. See **Wireless Accessory Charging** (page 132).
- G Passenger airbag deactivation indicator.
- H Auto-Start-Stop button. See **Auto-Start-Stop** (page 146).
- I Traction control switch. See **Using Traction Control** (page 176).
- J Climate control. See **Climate Control** (page 108).
- K Push button ignition switch. See **Push Button Ignition Switch** (page 135).
- L Cruise control buttons. See **Using Cruise Control** (page 195).
- M Lighting control. See **Lighting** (page 78).

# Child Safety

## GENERAL INFORMATION

See the following sections for directions on how to properly use safety restraints for children.



**WARNING:** Always make sure your child is secured properly in a device that is appropriate for their height, age and weight. Child safety restraints must be bought separately from your vehicle. Failure to follow these instructions and guidelines may result in an increased risk of serious injury or death to your child.



**WARNING:** All children are shaped differently. The National Highway Traffic Safety Administration and other safety organizations, base their recommendations for child restraints on probable child height, age and weight thresholds, or on the minimum requirements of the law. We recommend that you check with a NHTSA Certified Child Passenger Safety

Technician (CPST) to make sure that you properly install the child restraint in your vehicle and that you consult your pediatrician to make sure you have a child restraint appropriate for your child. To locate a child restraint fitting station and CPST, contact NHTSA toll free at 1-888-327-4236 or go to [www.nhtsa.dot.gov](http://www.nhtsa.dot.gov). In Canada, contact Transport Canada toll free at 1-800-333-0371 or go to [www.tc.gc.ca](http://www.tc.gc.ca) to find a Child Car Seat Clinic in your area. Failure to properly restrain children in child restraints made especially for their height, age and weight, may result in an increased risk of serious injury or death to your child.



**WARNING:** On hot days, the temperature inside the vehicle can rise very quickly. Exposure of people or animals to these high temperatures for even a short time can cause death or serious heat related injuries, including brain damage. Small children are particularly at risk.

# Child Safety

## Recommendations for Safety Restraints for Children

Child	Child size, height, weight, or age	Recommended restraint type
Infants or toddlers	Children weighing 40 lb (18 kg) or less (generally age four or younger).	Use a child safety seat (sometimes called an infant carrier, convertible seat, or toddler seat).
Small children	Children who have outgrown or no longer properly fit in a child safety seat (generally children who are less than 4 ft. 9 in. (1.45 m) tall, are greater than age four and less than age 12, and between 40 lb (18 kg) and 80 lb (36 kg) and upward to 100 lb (45 kg) if recommended by your child restraint manufacturer).	Use a belt-positioning booster seat.
Larger children	Children who have outgrown or no longer properly fit in a belt-positioning booster seat (generally children who are at least 4 ft. 9 in. (1.45 m) tall or greater than 80 lb (36 kg) or 100 lb (45 kg) if recommended by child restraint manufacturer).	Use a vehicle seatbelt having the lap belt snug and low across the hips, shoulder belt centered across the shoulder and chest, and seatback upright.

- You are required by law to properly use safety seats for infants and toddlers in the United States and Canada.
- Many states and provinces require that small children use approved booster seats until they reach age eight, a height of 4 feet 9 inches (1.45 meters) tall, or 80 lb (36 kg). Check your local and state or provincial laws for specific requirements about the safety of children in your vehicle.
- When possible, always properly restrain children 12 years of age and under in a rear seating position of your vehicle. Accident statistics suggest that children are safer when properly restrained in the rear seating positions than in a front seating position. See **Front Passenger Sensing System** (page 42).

## INSTALLING CHILD RESTRAINTS

### Child Restraints





E142594

# Child Safety

Use a child safety restraint (sometimes called an infant carrier, convertible seat, or toddler seat) for infants, toddlers, or children weighing 40 lb (18 kg) or less (generally age four or younger).

## Using Lap and Shoulder Belts

 **WARNING:** Airbags can kill or injure a child in a child restraint. Never place a rear-facing child restraint in front of an active airbag. If you must use a forward-facing child restraint in the front seat, move the seat upon which the child restraint is installed all the way back.

 **WARNING:** Airbags can kill or injure a child in a child restraint. Properly restrain children 12 and under in the rear seat whenever possible.

 **WARNING:** Depending on where you secure a child restraint, and depending on the child restraint design, you may block access to certain seatbelt buckle assemblies and LATCH lower anchors, rendering those features potentially unusable. To avoid risk of injury, make sure occupants only use seating positions where they are able to be properly restrained.

When installing a child safety restraint with combination lap and shoulder belts:

- Use the correct seatbelt buckle for that seating position.
- Insert the belt tongue into the proper buckle until you hear a snap and feel it latch. Make sure the tongue is securely fastened in the buckle.
- Keep the buckle release button pointing up and away from the safety restraint, with the tongue between the child restraint and the release button, to prevent accidental unbuckling.

- Place the vehicle seat upon which the child restraint will be installed in the upright position.
- Put the seatbelt in the automatic locking mode. See Step 5. This vehicle does not require the use of a locking clip.

Perform the following steps when installing the child restraint with combination lap and shoulder belts:

**Note:** *Although the child restraint illustrated is a forward facing child restraint, the steps are the same for installing a rear facing child restraint.*



E142528

1. Position the child safety restraint in a seat with a combination lap and shoulder belt.



E142529



# Child Safety

2. Pull down on the shoulder belt and then grasp the shoulder belt and lap belt together.



E142530

3. While holding the shoulder and lap belt portions together, route the tongue through the child restraint according to the child restraint manufacturer's instructions. Be sure the belt webbing is not twisted.

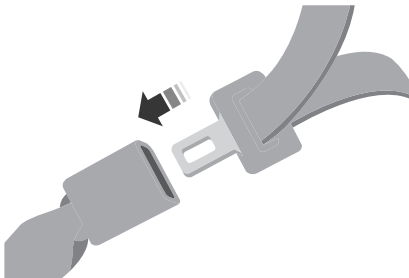

E142531

4. Insert the belt tongue into the proper buckle (the buckle closest to the direction the tongue is coming from) for that seating position until you hear a snap and feel the latch engage. Make sure the tongue is latched securely by pulling on it.



E142875

5. To put the retractor in the automatic locking mode, grasp the shoulder portion of the belt and pull downward until all of the belt is pulled out.

**Note:** *The automatic locking mode is available on the front passenger and rear seats.*

6. Allow the belt to retract to remove slack. The belt will click as it retracts to indicate it is in the automatic locking mode.
7. Try to pull the belt out of the retractor to make sure the retractor is in the automatic locking mode (you should not be able to pull more belt out). If the retractor is not locked, unbuckle the belt and repeat Steps 5 and 6.



E142533

# Child Safety

- Remove remaining slack from the belt. Force the seat down with extra weight, for example, by pressing down or kneeling on the child restraint while pulling up on the shoulder belt in order to force slack from the belt. This is necessary to remove the remaining slack that will exist once the extra weight of the child is added to the child restraint. It also helps to achieve the proper snugness of the child restraint to your vehicle. Sometimes, a slight lean toward the buckle will additionally help to remove remaining slack from the belt.
- Attach the tether strap (if the child restraint is equipped).

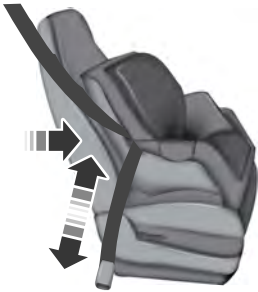

E142534

- Before placing the child in the seat, forcibly move the seat forward and back to make sure the seat is securely held in place. To check this, grab the seat at the belt path and attempt to move it side to side and forward and back. There should be no more than 1 in (2.5 cm) of movement for proper installation.

We recommend checking with a NHTSA Certified Child Passenger Safety Technician to make certain the child restraint is properly installed. In Canada, check with Transport Canada for referral to a Child Car Seat Clinic.

## Using Lower Anchors and Tethers for Children (LATCH)



**WARNING:** Do not attach two child safety restraints to the same anchor. In a crash, one anchor may not be strong enough to hold two child safety restraint attachments and may break, causing serious injury or death.



**WARNING:** Depending on where you secure a child restraint, and depending on the child restraint design, you may block access to certain seatbelt buckle assemblies and LATCH lower anchors, rendering those features potentially unusable. To avoid risk of injury, make sure occupants only use seating positions where they are able to be properly restrained.

The LATCH system is composed of three vehicle anchor points: two lower anchors located where the seatback and seat cushion meet (called the seat bight) and one top tether anchor located behind that seating position.

LATCH compatible child safety restraints have two rigid or webbing mounted attachments that connect to the two lower anchors at the LATCH equipped seating positions in your vehicle. This type of attachment method eliminates the need to use seatbelts to attach the child restraint, however the seatbelt can still be used to attach the child restraint. For forward-facing child restraints, the top tether strap must also be attached to the proper top tether anchor, if a top tether strap has been provided with your child restraint.

# Child Safety

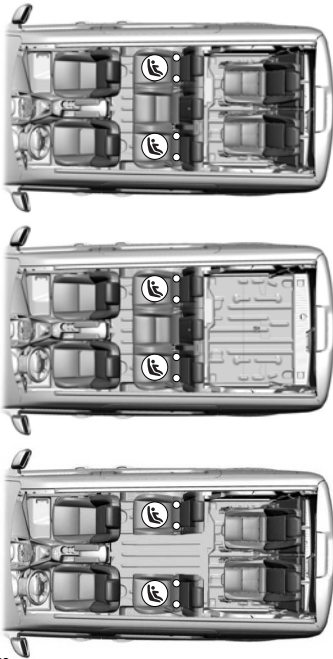

E196358

Your vehicle has LATCH lower anchors for child restraint installation at the seating positions marked with the child restraint symbol.

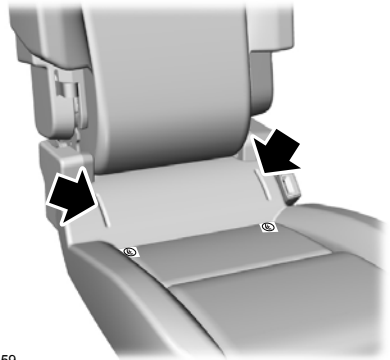

E196359

The LATCH anchors are located at the rear section of the rear seat between the cushion and seatback above the symbols as shown. Follow the child restraint manufacturer's instructions to properly install a child restraint with LATCH attachments. Follow the instructions on attaching child safety restraints with tether straps.

Attach LATCH lower attachments of the child restraint only to the anchors shown.

## **Use of Inboard Lower Anchors from the Outboard Seating Positions (Center Seating Use - If Equipped)**



**WARNING:** The standardized spacing for LATCH lower anchors is 11 in (280 mm) center to center. Do not use LATCH lower anchors for the center seating position unless the child restraint manufacturer's instructions permit and specify using anchors spaced at least as far apart as those in this vehicle.

# Child Safety

The lower anchors at the center of the second row rear seat are spaced 22 in (56 cm) apart. A child restraint with rigid LATCH attachments cannot be installed at the center seating position. LATCH compatible child restraints (with attachments on belt webbing) can only be used at this seating position provided that the child restraint manufacturer's instructions permit use with the anchor spacing stated. Do not attach a child restraint to any lower anchor if an adjacent child restraint is attached to that anchor.

Each time you use the safety restraint, check that the seat is properly attached to the lower anchors and tether anchor, if applicable. Tug the child restraint from side to side and forward and back where it is secured to your vehicle. The seat should move less than 1 in (2.5 cm) when you do this for a proper installation.

If the safety restraint is not anchored properly, the risk of a child being injured in a crash greatly increases.

## Combining Seatbelt and LATCH Lower Anchors for Attaching a Child Safety Restraint

When used in combination, either the seatbelt or the LATCH lower anchors may be attached first, provided a proper installation is achieved. Attach the tether strap afterward, if included with the child restraint.

## Using Tether Straps



**WARNING:** Do not tie down cargo to anchors if the anchors are in use as child tethers.



Many forward-facing child safety restraints include a tether strap which extends from the back of the child safety restraint and hooks to an anchoring point called the top tether anchor. Tether straps are available as an accessory for many older safety restraints.

Contact the manufacturer of your child restraint for information about ordering a tether strap, or to obtain a longer tether strap if the tether strap on your safety restraint does not reach the appropriate top tether anchor in your vehicle.

Once the child safety restraint has been installed using either the seatbelt, the lower anchors of the LATCH system, or both, you can attach the top tether strap.

The tether strap anchors in your vehicle are in the following positions (shown from top view):

# Child Safety

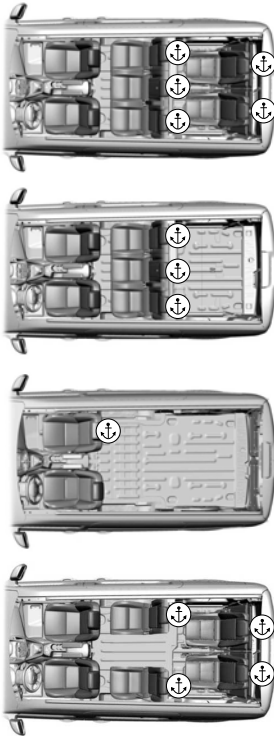

E195335

Perform the following steps to install a child safety restraint with tether anchors:

**Note:** *If you install a child restraint with rigid LATCH attachments, do not tighten the tether strap enough to lift the child restraint off your vehicle seat cushion when the child is seated in it. Keep the tether strap just snug without lifting the front of the child restraint. Keeping the child restraint just touching your vehicle seat gives the best protection in a severe crash.*

## First and Second Row

1. Route the child safety restraint tether strap over the back of the seat. For the outboard seating positions, route the tether strap under the head restraint and between the head restraint posts. For the second row center seating position, route the tether strap over the top of the head restraint. If needed, the head restraints can also be removed.



E195339

2. Locate the correct anchor on the back panel of the rear seat for the selected seating position. The anchors are partially covered by the gap panel. Pull the panel back to fully expose the anchors.
3. Clip the tether strap to the anchor as shown.
4. Tighten the child safety restraint tether strap according to the manufacturer's instructions. If your child restraint system is equipped with a tether strap, and the child restraint manufacturer recommends its use, we also recommend its use.

# Child Safety

## Third Row

1. Route the child safety restraint tether strap over the back of the seat. For the third row outboard seating positions, route the tether strap under the head restraint and between the head restraint posts. If needed, the head restraints can also be removed.



E213400

2. Locate the correct anchor at the rear of the cargo area for the selected seating position.
3. Clip the tether strap to the anchor as shown.
4. Tighten the child safety restraint tether strap according to the manufacturer's instructions. If your child restraint system is equipped with a tether strap, and the child restraint manufacturer recommends its use, we also recommend its use.

## BOOSTER SEATS



**WARNING:** Do not put the shoulder section of the seatbelt or allow the child to put the shoulder section of the seatbelt under their arm or behind their back. Failure to follow this instruction could reduce the effectiveness of the seatbelt and increase the risk of injury or death in a crash.

Use a belt-positioning booster seat for children who have outgrown or no longer properly fit in a child safety restraint (generally children who are less than 57 in (1.45 m) tall, are greater than age 4 and less than age 12, and between 40 lb (18 kg) and 80 lb (36 kg) and upward to 100 lb (45 kg) if recommended by your child restraint manufacturer). Many state and provincial laws require that children use approved booster seats until they reach age eight, a height of 57 in (1.45 m) tall, or 80 lb (36 kg).

Booster seats should be used until you can answer YES to ALL of these questions when seated without a booster seat:

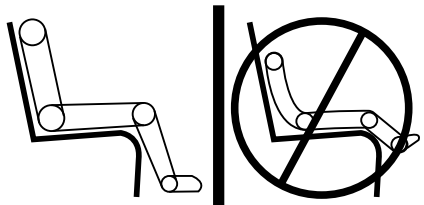

E142595

- Can the child sit all the way back against their vehicle seat backrest with knees bent comfortably at the edge of the seat cushion?
- Can the child sit without slouching?

# Child Safety

- Does the lap belt rest low across the hips?
- Is the shoulder belt centered on the shoulder and chest?
- Can the child stay seated like this for the whole trip?

Always use booster seats in conjunction with your vehicle lap and shoulder belt.

## Types of Booster Seats



E68924

- Backless booster seats

If your backless booster seat has a removable shield, remove the shield. If a vehicle seating position has a low seat backrest or no head restraint, a backless booster seat may place your child's head (as measured at the tops of the ears) above the top of the seat. In this case, move the backless booster to another seating position with a higher seat backrest or head restraint and lap and shoulder belts, or consider using a high back booster seat.



E70710

- High back booster seats

If, with a backless booster seat, you cannot find a seating position that adequately supports your child's head, a high back booster seat would be a better choice.

Children and booster seats vary in size and shape. Choose a booster that keeps the lap belt low and snug across the hips, never up across the stomach, and lets you adjust the shoulder belt to cross the chest and rest snugly near the center of the shoulder. The following drawings compare the ideal fit (center) to a shoulder belt uncomfortably close to the neck and a shoulder belt that could slip off the shoulder. The drawings also show how the lap belt should be low and snug across the child's hips.

# Child Safety



E142596



E142597

If the booster seat slides on the vehicle seat upon which it is being used, placing a rubberized mesh sold as shelf or carpet liner under the booster seat may improve this condition. Do not introduce any item thicker than this under the booster seat. Check with the booster seat manufacturer's instructions.

## CHILD RESTRAINT POSITIONING

**WARNING:** Do not place a rearward facing child restraint in front of an active airbag. Failure to follow this instruction could result in personal injury or death.

**WARNING:** Properly secure children 12 years old and under in a rear seating position whenever possible. If you are unable to properly secure all children in a rear seating position, properly secure the largest child on the front seat. If you must use a forward facing child restraint on the front seat, move the seat as far back as possible. Failure to follow these instructions could result in personal injury or death.

**WARNING:** Always carefully follow the instructions and warnings provided by the manufacturer of any child restraint to determine if the restraint device is appropriate for your child's size, height, weight, or age. Follow the child restraint



# Child Safety

manufacturer's instructions and warnings provided for installation and use in conjunction with the instructions and warnings provided by your vehicle manufacturer. A safety seat that is improperly installed or utilized, is inappropriate for your child's height, age, or weight or does not properly fit the child may increase the risk of serious injury or death.



**WARNING:** Do not allow a passenger to hold a child on their lap when your vehicle is moving. Failure to follow this instruction could result in personal injury or death in the event of a sudden stop or crash.



**WARNING:** Do not use pillows, books or towels to boost your child's height. Failure to follow this instruction could result in personal injury or death.



**WARNING:** Properly secure child restraints or booster seats when they are not in use. They could become projectiles in a sudden stop or crash. Failure to follow this instruction could result in personal injury or death.



**WARNING:** Do not put the shoulder section of the seatbelt or allow the child to put the shoulder section of the seatbelt under their arm or behind their back. Failure to follow this instruction could reduce the effectiveness of the seatbelt and increase the risk of injury or death in a crash.



**WARNING:** Do not leave children or pets unattended in your vehicle. Failure to follow this instruction could result in personal injury or death.

# Child Safety

## Recommendations for Attaching Child Safety Restraints for Children

Restraint Type	Combined Weight of Child and Child Restraint	Use Any Attachment Method as Indicated Below by X				
		LATCH (Lower Anchors and Top Tether Anchor)	LATCH (Lower Anchors Only)	Seatbelt and Top Tether Anchor	Seatbelt and LATCH (Lower Anchors and Top Tether Anchor)	Seatbelt Only
Rear facing child restraint	Up to 65 lb (29.5 kg)		X			X
Rear facing child restraint	Over 65 lb (29.5 kg)					X
Forward facing child restraint	Up to 65 lb (29.5 kg)	X		X	X	
Forward facing child restraint	Over 65 lb (29.5 kg)			X	X	

**Note:** The child restraint must rest tightly against the vehicle seat upon which it is installed. It may be necessary to lift or remove the head restraint. See **Seats** (page 115).

## CHILD SAFETY LOCKS



**WARNING:** You cannot open the rear doors from inside if you have put the child safety locks on.

# Child Safety

---

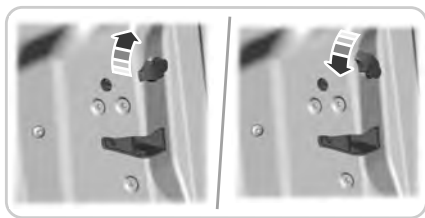

E189148

A child safety lock is on the rear edge of each rear door. You must set the child safety lock separately on each door.

## **Left-Hand Side**

Turn counterclockwise to lock and clockwise to unlock.

## **Right-Hand Side**

Turn clockwise to lock and counterclockwise to unlock.

# Seatbelts

## PRINCIPLE OF OPERATION



**WARNING:** Always drive and ride with your seatback upright and the lap belt snug and low across the hips.



**WARNING:** Children must always be properly restrained.



**WARNING:** Do not allow a passenger to hold a child on their lap when your vehicle is moving. Failure to follow this instruction could result in personal injury or death in the event of a sudden stop or crash.



**WARNING:** All occupants of your vehicle, including the driver, should always properly wear their seatbelts, even when an airbag supplemental restraint system is provided. Failure to properly wear your seatbelt could seriously increase the risk of injury or death.



**WARNING:** It is extremely dangerous to ride in a cargo area, inside or outside of a vehicle. In a crash, people riding in these areas are more likely to be seriously injured or killed. Do not allow people to ride in any area of your vehicle that is not equipped with seats and seatbelts. Make sure everyone in your vehicle is in a seat and properly using a seatbelt. Failure to follow this warning could result in serious personal injury or death.



**WARNING:** In a rollover crash, an unbelted person is significantly more likely to die than a person wearing a seatbelt.



**WARNING:** Each seating position in your vehicle has a specific seatbelt assembly made up of one buckle and one tongue designed to be used as a pair. Use the shoulder belt on the outside shoulder only. Never wear the shoulder belt under the arm. Never use a single seatbelt for more than one person.



**WARNING:** Properly secure children 12 years old and under in a rear seating position whenever possible. If you are unable to properly secure all children in a rear seating position, properly secure the largest child on the front seat. If you must use a forward facing child restraint on the front seat, move the seat as far back as possible. Failure to follow these instructions could result in personal injury or death.



**WARNING:** Seatbelts and seats may be hot in a vehicle that is in the sunshine. The hot seatbelts or seats may burn a small child. Check seat covers and buckles before you place a child anywhere near them.



**WARNING:** Always ride and drive with your seatback upright and properly fasten your seatbelt. Fit the lap portion of the seatbelt snugly and low across the hips. Position the shoulder portion of the seatbelt across your chest. Pregnant women must follow this practice. See the following figure.

All seating positions in your vehicle have lap and shoulder seatbelts. All occupants of the vehicle should always properly wear their seatbelts, even when an airbag supplemental restraint system is provided.

# Seatbelts

The seatbelt system consists of:

- Lap and shoulder seatbelts.
- Shoulder seatbelt with automatic locking mode (except driver seatbelt).
- Height adjuster at the front outboard seating positions.
- Seatbelt pretensioner at the front and second row outermost seating positions.
- Belt tension sensor at the front outboard passenger seating position.



- Seatbelt warning light and chime.



- Crash sensors and monitoring system with readiness indicator.

The seatbelt pretensioners at the front and second row outermost seating positions are designed to tighten the seatbelts when activated. In frontal and near-frontal crashes, the seatbelt pretensioners may be activated alone or, if the crash is of sufficient severity, together with the front airbags. The pretensioners may also activate when the Safety Canopy is deployed.

## FASTENING THE SEATBELTS

The front outermost and rear safety restraints in your vehicle are combination lap and shoulder belts.



E142587

1. Insert the seatbelt tongue into the proper buckle (the buckle closest to the direction the tongue is coming from) until you hear a snap and feel it latch.

**Note:** Make sure that the seatbelt tongue is properly fastened in the seatbelt buckle.



E142588

2. Press the button to release the seatbelt tongue.

# Seatbelts

## Using Seatbelts During Pregnancy

**WARNING:** Always ride and drive with your seatback upright and properly fasten your seatbelt. Fit the lap portion of the seatbelt snugly and low across the hips. Position the shoulder portion of the seatbelt across your chest. Pregnant women must follow this practice. See the following figure.

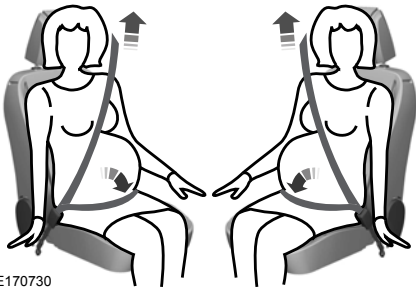

E170730

Pregnant women should always wear their seatbelt. The lap belt portion of a combination lap and shoulder belt should be positioned low across the hips below the belly and worn as tight as comfort allows. The shoulder belt should be positioned to cross the middle of the shoulder and the center of the chest.

## Seatbelt Locking Modes

**WARNING:** After a crash, have a qualified technician check all the seatbelts to make sure the seatbelts including the automatic locking retractor feature for child restraints operate properly. We recommend replacing any system that has damage or does not operate properly. Failure to do so can result in personal injury or death in the event of a sudden stop or another crash.

**WARNING:** You must replace the seatbelt if the automatic locking retractor or any other seatbelt function is not operating correctly. Failure to replace the seatbelt and retractor assembly could increase the risk of injury in a crash.

The driver seatbelt has the first type of locking mode, and the front outboard passenger and rear seat seatbelts have both types of locking modes described as follows:

### Vehicle Sensitive Mode

This is the normal retractor mode which allows free shoulder belt length adjustment to your movements and locking in response to vehicle movement. For example, if you brake suddenly or turn a corner sharply, or your vehicle receives an impact of approximately 5 mph (8 km/h) or more, the combination seatbelts lock to help reduce forward movement of the driver and passengers.

In addition, the retractor is designed to lock if you pull the webbing out too quickly. If the seatbelt retractor locks, slowly lower the height adjuster to allow the seatbelt to retract. If the retractor does not unlock, pull the seatbelt out slowly then feed a

# Seatbelts

small length of webbing back toward the stowed position. For rear seatbelts, recline the rear seat backrest or push the seat backrest cushion away from the seatbelt. Feed a small length of webbing back toward the stowed position.

## Automatic Locking Mode

In this mode, the shoulder belt automatically pre-locks. The seatbelt still retracts to remove any slack in the shoulder belt. The automatic locking mode is not available on the driver seatbelt.

## Using Automatic Locking Mode

You should use automatic locking mode when a child safety seat, except a booster, is on the front passenger seat or rear seat. Children 12 years old and under should be correctly restrained in a rear seating position whenever possible. See **Child Safety** (page 18).



E142591

1. Buckle the combination lap and shoulder belt.
2. Grasp the shoulder portion and pull downward until you pull the entire seatbelt out.
3. Let the seatbelt retract.

**Note:** As the seatbelt retracts, you will hear a clicking sound. This indicates the seatbelt is now in the automatic locking mode.

## Disengaging Automatic Locking Mode

Unbuckle the combination lap and shoulder belt and allow it to retract completely to disengage the automatic locking mode and return the seatbelt to the vehicle sensitive mode.

## SEATBELT HEIGHT ADJUSTMENT

**WARNING:** Position the seatbelt height adjuster so that the seatbelt rests across the middle of your shoulder. Failure to adjust the seatbelt correctly could reduce its effectiveness and increase the risk of injury in a crash.

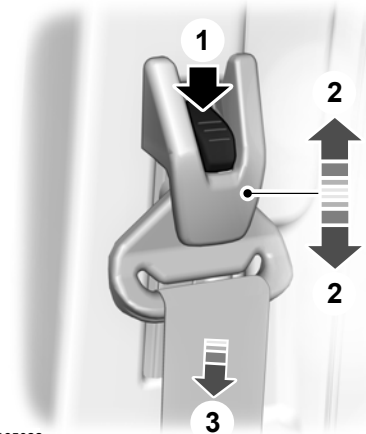

E165022

1. Press the button.
2. Slide the height adjuster up or down.
3. Release the button and pull down on the height adjuster to make sure it is locked in place.

# Seatbelts

## SEATBELT WARNING LAMP AND INDICATOR CHIME



This lamp illuminates and an audible warning will sound if the driver seatbelt has not been fastened when the vehicle's ignition is turned on.

### Conditions of operation

If	Then
The driver seatbelt is not buckled before the ignition switch is turned to the on position...	The seatbelt warning light illuminates and the warning chime sounds for a few seconds.
The driver seatbelt is buckled while the indicator light is illuminated and the warning chime is sounding...	The seatbelt warning light and warning chime turn off.
The driver seatbelt is buckled before the ignition switch is turned to the on position...	The seatbelt warning light and indicator chime remain off.

## SEATBELT REMINDER

### Belt-Minder™

This feature supplements the seatbelt warning function by providing additional reminders that intermittently sound a tone and illuminate the seatbelt warning light when you are in the driver seat or you have a front seat passenger and a seatbelt is unbuckled.

The system uses information from the front passenger sensing system to determine if a front seat passenger is present and therefore potentially in need of a warning. To avoid the system turning on the Belt-Minder feature for objects you place on the front passenger seat, only the front seat passengers receive warnings as determined by the front passenger sensing system.

If the Belt-Minder warnings expire (warnings for about five minutes) for one passenger (driver or front passenger), the other passenger can still cause the Belt-Minder feature to turn on.



# Seatbelts

If...	Then...
You and the front seat passenger buckle your seatbelts before you switch the ignition on or less than 1–2 minutes elapse after you switch the ignition on...	The Belt-Minder feature will not activate.
You or the front seat passenger do not buckle your seatbelts before your vehicle reaches at least 6 mph (9.7 km/h) and 1–2 minutes elapse after you switch the ignition on...	The Belt-Minder feature activates, the seatbelt warning light illuminates and a warning tone sounds for 6 seconds every 25 seconds, repeating for about 5 minutes or until you and the front seat passenger buckle your seatbelts.
The seatbelt for the driver or front passenger is unbuckled for about 1 minute while the vehicle is traveling at least 6 mph (9.7 km/h) and more than 1–2 minutes elapse after you switch the ignition on...	The Belt-Minder feature activates, the seatbelt warning light illuminates and a warning tone sounds for 6 seconds every 25 seconds, repeating for about 5 minutes or until you and the front seat passenger buckle your seatbelts.

## Deactivating and Activating the Belt-Minder Feature



**WARNING:** While the system allows you to deactivate it, this system is designed to improve your chances of being safely belted and surviving an accident. We recommend you leave the system activated for yourself and others who may use the vehicle.

**Note:** *The driver and front passenger warnings switch on and off independently. When you perform this procedure for one seating position, do not buckle the other position as this will terminate the process.*

Read Steps 1–4 thoroughly before proceeding with the programming procedure.

Before following the procedure, make sure that:

- The parking brake is set.
- The transmission is in park (P).
- The ignition is off.
- The driver and front passenger seatbelts are unbuckled.

1. Switch the ignition on. Do not start the vehicle.
2. Wait until the seatbelt warning light turns off (about 1 minute). After Step 2, wait an additional 5 seconds before proceeding with Step 3. Once you start Step 3, you must complete the procedure within 30 seconds.
3. For the seating position you are switching off, buckle then unbuckle the seatbelt four times at a moderate speed, ending in the unbuckled state. After Step 3, the seatbelt warning light turns on.

# Seatbelts

4. While the seatbelt warning light is on, buckle and then unbuckle the seatbelt. After Step 4, the seatbelt warning light flashes for confirmation.
- This will switch the feature off for that seating position if it is currently on.
  - This will switch the feature on for that seating position if it is currently off.

## CHILD RESTRAINT AND SEATBELT MAINTENANCE

Inspect the vehicle seatbelts and child safety seat systems periodically to make sure they work properly and are not damaged. Inspect the vehicle and child restraint seatbelts to make sure there are no nicks, tears or cuts. Replace if necessary. All vehicle seatbelt assemblies, including retractors, buckles, front seatbelt buckle assemblies, buckle support assemblies (slide bar-if equipped), shoulder belt height adjusters (if equipped), shoulder belt guide on seat backrest (if equipped), child safety seat LATCH and tether anchors, and attaching hardware, should be inspected after a crash. Read the child restraint manufacturer's instructions for additional inspection and maintenance information specific to the child restraint.

We recommend that all seatbelt assemblies in use in vehicles involved in a crash be replaced. However, if the crash was minor and an authorized dealer finds that the belts do not show damage and continue to operate properly, they do not need to be replaced. Seatbelt assemblies not in use during a crash should also be inspected and replaced if either damage or improper operation is noted.

Properly care for seatbelts. See **Vehicle Care** (page 286).

## SEATBELT EXTENSION



**WARNING:** Persons who fit into the vehicle's seatbelt should not use an extension. Unnecessary use could result in serious personal injury in the event of a crash.



**WARNING:** Only use extensions provided free of charge by Ford Motor Company dealers. The dealer will provide an extension designed specifically for this vehicle, model year and seating position. The use of an extension intended for another vehicle, model year or seating position may not offer you the full protection of your vehicle's seatbelt restraint system.



**WARNING:** Never use seatbelt extensions to install child restraints.



**WARNING:** Do not use a seatbelt extension with an inflatable seatbelt.



**WARNING:** Do not use extensions to change the fit of the belt across the torso, over the lap or to make the seatbelt buckle easier to reach.

If, because of body size or driving position, it is not possible to properly fasten the seatbelt over your lap and shoulder, an extension that is compatible with the seatbelts is available free of charge from Ford Motor Company dealers. Only Ford seatbelt extensions made by the original equipment seatbelts manufacturer should be used with Ford seatbelts. Ask your authorized dealer if your extension is compatible with your Ford vehicle restraint system.

# Personal Safety System™

---

The Personal Safety System provides an improved overall level of frontal crash protection to front seat occupants and is designed to help further reduce the risk of airbag-related injuries. The system is able to analyze different occupant conditions and crash severity before activating the appropriate safety devices to help better protect a range of occupants in a variety of frontal crash situations.

The Vehicle Personal Safety System consists of:

- Driver and passenger dual-stage airbag supplemental restraints.
- Front seat outboard seatbelts with pretensioners, energy management retractors and seatbelt usage sensors.
- Driver seat position sensor.
- Front passenger sensing system.
- Passenger airbag status indicator.
- Front crash severity sensors.
- Restraints control module with impact and safing sensors.
- Restraint system warning lamp and tone.
- The electrical wiring for the airbags, crash sensors, seatbelt pretensioners, front seatbelt usage sensors, driver seat position sensor, front passenger sensing system and indicator lights.

## **How Does the Personal Safety System Work?**

The Personal Safety System can adapt the deployment strategy of the safety devices according to crash severity and occupant conditions. A collection of crash and occupant sensors provides information to the restraints control module. During a crash, the restraints control module may deploy the seatbelt pretensioners, one or both stages of the dual-stage airbags based on crash severity and occupant conditions.

# Supplementary Restraints System

## PRINCIPLE OF OPERATION



**WARNING:** Airbags do not inflate slowly or gently, and the risk of injury from a deploying airbag is the greatest close to the trim covering the airbag module.



**WARNING:** All occupants of your vehicle, including the driver, should always properly wear their seatbelts, even when an airbag supplemental restraint system is provided. Failure to properly wear your seatbelt could seriously increase the risk of injury or death.



**WARNING:** Even with advanced restraints systems, properly restrain children 12 and under in a rear seating position. Failure to follow this could seriously increase the risk of injury or death.



**WARNING:** Do not place your arms on the airbag cover or through the steering wheel. Failure to follow this instruction could result in personal injury.



**WARNING:** Keep the areas in front of the airbags free from obstruction. Do not affix anything to or over the airbag covers. Objects could become projectiles during airbag deployment or in a sudden stop. Failure to follow this instruction could result in personal injury or death.



**WARNING:** Airbags can kill or injure a child in a child restraint. Never place a rear-facing child restraint in front of an active airbag. If you must use a forward-facing child restraint in the front seat, move the seat upon which the child restraint is installed all the way back.



**WARNING:** Do not attempt to service, repair, or modify the supplementary restraint system or associated components. Failure to follow this instruction could result in personal injury or death.



**WARNING:** Several airbag system components get hot after inflation. To reduce the risk of injury, do not touch them after inflation.



**WARNING:** If a supplementary restraint system component has deployed, it will not function again. Have the system and associated components inspected as soon as possible. Failure to follow this instruction could result in personal injury or death.

The airbags are a supplemental restraint system and are designed to work with the seatbelts to help protect the driver and right front passenger from certain upper body injuries. Airbags do not inflate slowly; there is a risk of injury from a deploying airbag.

**Note:** *You will hear a loud bang and see a cloud of harmless powdery residue if an airbag deploys. This is normal.*

The airbags inflate and deflate rapidly upon activation. After airbag deployment, it is normal to notice a smoke-like, powdery residue or smell the burnt propellant. This may consist of cornstarch, talcum powder (to lubricate the bag) or sodium compounds (for example, baking soda) that result from the combustion process that inflates the airbag. Small amounts of sodium hydroxide may be present which may irritate the skin and eyes, but none of the residue is toxic.

# Supplementary Restraints System

While the system is designed to help reduce serious injuries, contact with a deploying airbag may also cause abrasions or swelling. Temporary hearing loss is also a possibility as a result of the noise associated with a deploying airbag. Because airbags must inflate rapidly and with considerable force, there is the risk of death or serious injuries such as fractures, facial and eye injuries or internal injuries, particularly to occupants who are not properly restrained or are otherwise out of position at the time of airbag deployment. Thus, it is extremely important that occupants be properly restrained as far away from the airbag module as possible while maintaining vehicle control.

Routine maintenance of the airbags is not required.

## DRIVER AND PASSENGER AIRBAGS

 **WARNING:** Do not place your arms on the airbag cover or through the steering wheel. Failure to follow this instruction could result in personal injury.

 **WARNING:** Keep the areas in front of the airbags free from obstruction. Do not affix anything to or over the airbag covers. Objects could become projectiles during airbag deployment or in a sudden stop. Failure to follow this instruction could result in personal injury or death.

 **WARNING:** Airbags can kill or injure a child in a child restraint. Never place a rear-facing child restraint in front of an active airbag. If you must use a forward-facing child restraint in the front seat, move the seat upon which the child restraint is installed all the way back.

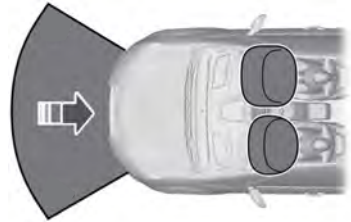

E151127

The driver and front passenger airbags will deploy during significant frontal and near frontal crashes.

The driver and passenger front airbag system consists of:

- Driver and passenger airbag modules.
- Front passenger sensing system.
- Crash sensors and monitoring system with readiness indicator. See **Crash Sensors and Airbag Indicator** (page 47).

## Proper Driver and Front Passenger Seating Adjustment

 **WARNING:** National Highway Traffic Safety Administration (NHTSA) recommends a minimum distance of at least 10 in (25 cm) between an occupant's chest and the driver airbag module.

To properly position yourself away from the airbag:

- Move your seat to the rear as far as you can while still reaching the pedals comfortably.
- Recline the seat slightly (one or two degrees) from the upright position.

# Supplementary Restraints System

After all occupants have adjusted their seats and put on seatbelts, it is very important that they continue to sit properly. A properly seated occupant sits upright, leaning against the seatback, and centered on the seat cushion, with their feet comfortably extended on the floor. Sitting improperly can increase the chance of injury in a crash event. For example, if an occupant slouches, lies down, turns sideways, sits forward, leans forward or sideways, or puts one or both feet up, the chance of injury during a crash is greatly increased.

## Children and Airbags

**WARNING:** Airbags can kill or injure a child in a child restraint. Never place a rear-facing child restraint in front of an active airbag. If you must use a forward-facing child restraint in the front seat, move the seat upon which the child restraint is installed all the way back.



E142846

Children must always be properly restrained. Accident statistics suggest that children are safer when properly restrained in the rear seating positions than in the front seating position. Failure to follow these instructions may increase the risk of injury in a crash.

## FRONT PASSENGER SENSING SYSTEM

**WARNING:** Even with advanced restraints systems, properly restrain children 12 and under in a rear seating position. Failure to follow this could seriously increase the risk of injury or death.

**WARNING:** Sitting improperly, out of position or with the seatback reclined too far can take weight off the seat cushion and affect the decision of the passenger sensing system, resulting in serious injury or death in the event of a crash. Always sit upright against your seat back, with your feet on the floor.

**WARNING:** Do not stow objects in the seatback map pocket or hang objects off a seatback if a child is in the front passenger seat. Do not place objects under the front passenger seat or between the seat and the center console. Check the passenger airbag indicator lamp for proper airbag status. Failure to follow these instructions may interfere with the front passenger seat sensing system and increase the risk of serious injury.

**WARNING:** Any alteration or modification to the front passenger seat may affect the performance of the front passenger sensing system. This could seriously increase the risk of injury or death.

This system works with sensors that are part of the front passenger seat and seatbelt to detect the presence of a properly-seated occupant and determine if the front passenger frontal airbag should be enabled (may inflate) or not.

# Supplementary Restraints System



E279408

The front passenger sensing system uses a passenger airbag indicator which will illuminate indicating that the front passenger frontal airbag is either ON (enabled) or OFF (disabled).

The indicator lamp is in the center stack of the instrument panel.

**Note:** *When you first switch the ignition on, the indicator lamp illuminates for a short period of time to confirm it is functional.*

The front passenger sensing system is designed to disable (will not inflate) the front passenger frontal airbag when a rear facing infant seat, a forward-facing child restraint, or a booster seat is detected. Even with this technology, parents are **strongly** encouraged to always properly restrain children in the rear seat. The sensor also turns off the passenger front airbag and seat-mounted side airbag when the passenger seat is empty.

- When the front passenger sensing system disables (will not inflate) the front passenger frontal airbag, the OFF indicator lamp will illuminate and stay illuminated to remind you that the front passenger frontal airbag is disabled.
- If the child restraint has been installed and the passenger airbag status indicator illuminates the ON lamp, then turn the vehicle off, remove the child restraint from the vehicle and reinstall the restraint following the child restraint manufacturer's instructions.

The front passenger sensing system is designed to enable (may inflate) the front passenger frontal airbag anytime the system senses that a person of adult size is sitting properly in the front passenger seat.

- When the front passenger sensing system enables the front passenger frontal airbag (may inflate), the ON indicator lamp illuminates.

If a person of adult size is sitting in the front passenger seat, but the airbag OFF indicator lamp is illuminated, it is possible that the person is not sitting properly in the seat. If this happens:

- Turn the vehicle off and ask the person to place the seatback in the full upright position.
- Have the person sit upright in the seat, centered on the seat cushion, with the person's legs comfortably extended.
- Restart the vehicle and have the person remain in this position for about two minutes. This will allow the system to detect that person and enable the passenger frontal airbag.
- If the OFF indicator lamp remains illuminated even after this, the person should be advised to ride in the rear seat.

# Supplementary Restraints System

Occupant	Passenger airbag indicator	Passenger airbag
Empty	OFF: Lit	Disabled
	ON: Unlit	
Child	OFF: Lit	Disabled
	ON: Unlit	
Adult	OFF: Unlit	Enabled
	ON: Lit	

**Note:** When the passenger airbag OFF light is illuminated, the passenger (seat mounted) side airbag may be disabled to avoid the risk of airbag deployment injuries.

After all occupants have adjusted their seats and put on seatbelts, it is very important that they continue to sit properly. A properly seated occupant sits upright, leaning against the seat back, and centered on the seat cushion, with their feet comfortably extended on the floor. Sitting improperly can increase the chance of injury in a crash event. For example, if an occupant slouches, lies down, turns sideways, sits forward, leans forward or sideways, or puts one or both feet up, the chance of injury during a crash is greatly increased.

If you think that the status of the passenger airbag off indicator lamp is incorrect, check for the following:

- Objects lodged underneath the seat.
- Objects between the seat cushion and the center console.
- Objects hanging off the seatback.
- Objects stowed in the seatback map pocket.
- Objects placed on the occupant's lap.
- Cargo interference with the seat.

- Other passengers pushing or pulling on the seat.
- Rear passenger feet and knees resting or pushing on the seat.

The conditions listed above may cause the weight of a properly seated occupant to be incorrectly interpreted by the front passenger sensing system. The person in the front passenger seat may appear heavier or lighter due to the conditions described in the list above.



Make sure the front passenger sensing system is operating properly. See **Crash Sensors and Airbag Indicator** (page 47).

If the airbag readiness light is illuminated, do the following:

The driver and adult passengers should check for objects lodged underneath the front passenger seat, or cargo interfering with the seat.

If there are lodged objects, or cargo is interfering with the seat, take the following steps to remove the obstruction:

- Pull the vehicle over.
- Turn the vehicle off.
- Driver and adult passengers should check for any objects lodged underneath the front passenger seat or cargo interfering with the seat.



# Supplementary Restraints System

- Remove the obstruction(s) (if found).
- Restart the vehicle.
- Wait at least two minutes and verify that the airbag readiness light is no longer illuminated.
- If the airbag readiness light remains illuminated, this may or may not be a problem due to the front passenger sensing system.

Do not attempt to repair or service the system. Take your vehicle immediately to an authorized dealer.

If it is necessary to modify an advanced front airbag system to accommodate a person with disabilities, contact the Ford Customer Relationship Center. See **Getting the Services You Need** (page 247).

## SIDE AIRBAGS

 **WARNING:** Do not place objects or mount equipment on or near the airbag cover, on the side of the seatbacks (of the front seats), or in front seat areas that may come into contact with a deploying airbag. Failure to follow these instructions may increase the risk of personal injury in the event of a crash.

 **WARNING:** Do not use accessory seat covers. The use of accessory seat covers may prevent the deployment of the side airbags and increase the risk of injury in an accident.

 **WARNING:** Do not lean your head on the door. The side airbag could injure you as it deploys from the side of the seatback.

 **WARNING:** Do not attempt to service, repair, or modify the airbag, its fuses or the seat cover on a seat containing an airbag as you could be seriously injured or killed. Contact your authorized dealer as soon as possible.

 **WARNING:** If the side airbag has deployed, the airbag will not function again. The side airbag system (including the seat) must be inspected and serviced by an authorized dealer. If the airbag is not replaced, the unrepaired area will increase the risk of injury in a crash.

The side airbags are located on the outboard side of the seatbacks of the front seats. In certain sideways crashes, the airbag on the side affected by the crash will be inflated. The airbag was designed to inflate between the door panel and occupant to further enhance the protection provided occupants in side impact crashes.



E152533

The system consists of the following:

- A label or embossed side panel indicating that side airbags are fitted to your vehicle.
- Side airbags located inside the driver and front passenger seatbacks.
- Front passenger sensing system.

# Supplementary Restraints System



- Crash sensors and monitoring system with readiness indicator. See **Crash Sensors and Airbag Indicator** (page 47).

**Note:** *The passenger sensing system will deactivate the passenger seat-mounted side airbag if it detects an empty passenger seat.*

The design and development of the side airbag system included recommended testing procedures that were developed by a group of automotive safety experts known as the Side Airbag Technical Working Group. These recommended testing procedures help reduce the risk of injuries related to the deployment of side airbags.

## DRIVER KNEE AIRBAG

A driver's knee airbag is located under the instrument panel. During a crash, the restraints control module may activate the driver's knee airbag based on crash severity and occupant conditions. Under certain crash and occupant conditions, the driver's knee airbag may deploy but the driver's front airbag may not activate. As with front and side airbags, it is important to be properly seated and restrained to reduce the risk of death or serious injury.



- Make sure the knee airbag is operating properly. See **Crash Sensors and Airbag Indicator** (page 47).

## SAFETY CANOPY™



**WARNING:** Do not place objects or mount equipment on or near the headliner at the siderail that may come into contact with a deploying curtain airbag. Failure to follow these instructions may increase the risk of personal injury in the event of a crash.



**WARNING:** Do not lean your head on the door. The curtain airbag could injure you as it deploys from the headliner.



**WARNING:** Do not attempt to service, repair, or modify the supplementary restraint system or associated components. Failure to follow this instruction could result in personal injury or death.



**WARNING:** All occupants of your vehicle, including the driver, should always properly wear their seatbelts, even when an airbag supplemental restraint system is provided. Failure to properly wear your seatbelt could seriously increase the risk of injury or death.



**WARNING:** If the curtain airbags have deployed, the curtain airbags will not function again. The curtain airbags (including the A, B and C pillar trim and headliner) must be inspected and serviced as soon as possible. If the curtain airbag is not replaced, the unrepaired area will increase the risk of injury in a crash.

The Safety Canopy will deploy during significant side crashes or when a certain likelihood of a rollover event is detected by the rollover sensor. The Safety Canopy is mounted to the roof side-rail sheet metal, behind the headliner, above each row of seats. In certain sideways crashes

# Supplementary Restraints System

or rollover events, the Safety Canopy will be activated, regardless of which seats are occupied. The Safety Canopy is designed to inflate between the side window area and occupants to further enhance protection provided in side impact crashes and rollover events.

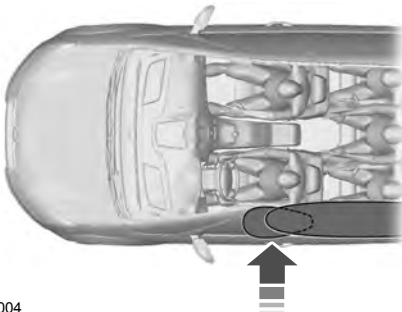

E75004

The system consists of the following:

- Safety canopy curtain airbags located above the trim panels over the front and rear side windows identified by a label or wording on the headliner or coat hook.
- A flexible headliner which opens above the side doors to allow air curtain deployment.



- The crash sensors and monitoring system have a readiness indicator. See **Crash Sensors and Airbag Indicator** (page 47).

Children 12 years old and under should always be properly restrained in the rear seats. The Safety Canopy will not interfere with children restrained using a properly installed child or booster seat because it is designed to inflate downward from the headliner above the doors along the side window opening.

The design and development of the Safety Canopy included recommended testing procedures that were developed by a group of automotive safety experts known as the Side Airbag Technical Working Group. These recommended testing procedures help reduce the risk of injuries related to the deployment of side airbags (including the Safety Canopy).

## CRASH SENSORS AND AIRBAG INDICATOR



**WARNING:** Modifying or adding equipment to the front end of your vehicle (including hood, bumper system, frame, front end body structure, tow hooks and hood pins) may affect the performance of the airbag system, increasing the risk of injury. Do not modify or add equipment to the front end of your vehicle.

Your vehicle has a collection of crash and occupant sensors which provide information to the restraints control module. The restraints control module deploys (activates) the seatbelt pretensioners, driver airbag, passenger airbag, knee airbag(s), seat mounted side airbags and the Safety Canopy. Based on the type of crash, the restraints control module deploys the appropriate safety devices.

The restraints control module also monitors the readiness of the above safety devices plus the crash and occupant sensors. The readiness of the safety system is indicated by a warning indicator light in the instrument cluster or by a backup tone if the warning light is not working. Routine maintenance of the airbag is not required.

A difficulty with the system is indicated by one or more of the following:

# Supplementary Restraints System

---



- The readiness light will not illuminate immediately after you switch the ignition on.
- The readiness light either flashes or stays lit.
- A series of five beeps is heard. The tone pattern repeats periodically until the problem, the light or both are repaired.

If any of these things happen, even intermittently, have the supplemental restraint system serviced at an authorized dealer immediately. Unless serviced, the system may not function properly in the event of a crash.

The seatbelt pretensioners and the front airbag supplemental restraint system are designed to activate when the vehicle sustains frontal deceleration sufficient to cause the restraints control module to deploy a safety device.

The fact that the seatbelt pretensioners or front airbags did not activate for both front seat occupants in a crash does not mean that something is wrong with the system. Rather, it means the restraints control module determined the accident conditions (crash severity, belt usage) were not appropriate to activate these safety devices.

- The front airbags are designed to activate only in frontal and near-frontal crashes (not rollovers, side impacts or rear impacts) unless the crash causes sufficient frontal deceleration.
- The seatbelt pretensioners are designed to activate in frontal, near-frontal and side crashes, and in rollovers.
- The knee airbag(s) may deploy based on crash severity and occupant conditions.

- The side airbags are designed to inflate in certain side impact crashes. Side airbags may activate in other types of crashes if the vehicle experiences sufficient sideways motion or deformation.
- The Safety Canopy is designed to inflate in certain side impact crashes or rollover events. The Safety Canopy may activate in other types of crashes if the vehicle experiences sufficient sideways motion or deformation, or a certain likelihood of rollover.

## AIRBAG DISPOSAL

Contact your authorized dealer as soon as possible. Airbags must be disposed of by qualified personnel.

# Automatic Crash Notification System

## 911 ASSIST



**WARNING:** Unless the 911 Assist setting is set on before a crash, the system will not dial for help which could delay response time, potentially increasing the risk of serious injury or death after a crash.



**WARNING:** Do not wait for 911 Assist to make an emergency call if you can do it yourself. Dial emergency services immediately to avoid delayed response time which could increase the risk of serious injury or death after a crash. If you do not hear 911 Assist within five seconds of the crash, the system or phone may be damaged or non-functional.



**WARNING:** Always place your phone in a secure location in your vehicle so it does not become a projectile or get damaged in a crash. Failure to do so may cause serious injury to someone or damage the phone which could prevent 911 Assist from working properly.

**Note:** *The SYNC 911 Assist feature must be set on before the incident.*

**Note:** *The SYNC 911 Assist feature only operates in the U.S., Canada or in a territory in which 911 is the emergency number.*

**Note:** *Before setting this feature on, make sure that you read the 911 Assist Privacy Notice later in this section for important information.*

**Note:** *If any user sets 911 Assist to on or off, that setting applies for all paired phones. If 911 Assist is switched off and the phone is connected to SYNC, an icon displays on the status bar.*

**Note:** *Every phone operates differently. While SYNC 911 Assist works with most cellular phones, some may have trouble using this feature.*

If a crash deploys an airbag (excluding knee airbags and rear inflatable seatbelts [if equipped]) or activates the fuel pump shut-off, your SYNC-equipped vehicle may be able to contact emergency services by dialing 911 through a paired and connected Bluetooth-enabled phone. You can learn more about the 911 Assist feature, by visiting:

Website
<a href="http://www.owner.ford.com">www.owner.ford.com</a>
<a href="http://www.syncmyride.ca">www.syncmyride.ca</a>
<a href="http://www.syncmaroute.ca">www.syncmaroute.ca</a>

For important information about airbag deployment and the fuel pump shut-off please see the Supplementary Restraints and Roadside Emergencies sections of your owner manual.

To switch 911 Assist on and off please view the settings information. See **Settings** (page 386).

To make sure that 911 Assist works correctly:

- SYNC must be powered and working properly at the time of the incident and throughout feature activation and use.
- The 911 Assist feature must be set on before the incident.
- You must pair and connect a Bluetooth-enabled and compatible cell phone to SYNC.
- A connected Bluetooth-enabled phone must have the ability to make and maintain an outgoing call at the time of the incident.
- A connected Bluetooth-enabled phone must have adequate network coverage, battery power and signal strength.
- The vehicle must have battery power and be located in the U.S., Canada or in a territory in which 911 is the emergency number.

# Automatic Crash Notification System

---

## In the Event of a Crash

Not all crashes will deploy an airbag or activate the fuel pump shut-off (the triggers for 911 Assist). If a connected cell phone sustains damage or loses its connection to SYNC during a crash, SYNC will search for and try to connect to a previously paired cell phone; SYNC will then attempt to call the emergency services.

Before making the call:

- SYNC provides a short window of time (about 10 seconds) to cancel the call. If you fail to cancel the call, SYNC attempts to dial 911.
- SYNC says the following, or a similar message: "SYNC will attempt to call 911, to cancel the call, press Cancel on your screen or press and hold the phone button on your steering wheel."

If you do not cancel the call, and SYNC makes a successful call, a pre-recorded message plays for the 911 operator, and then the occupant(s) in your vehicle is able to talk with the operator. Be prepared to provide your name, phone number and location immediately, because not all 911 systems are capable of receiving this information electronically.

## 911 Assist May Not Work If

- Your cellular phone or 911 Assist hardware sustains damage in a crash.
- The vehicle's battery or the SYNC system has no power.
- The phone(s) thrown from your vehicle are the ones paired and connected to the system.

## 911 Assist Privacy Notice

When you switch on 911 Assist, it may disclose to emergency services that your vehicle has been in a crash involving the deployment of an airbag or activation of the fuel pump shut-off. Certain versions or updates to 911 Assist may also be capable of electronically or verbally disclosing to 911 operators your vehicle location or other details about your vehicle or crash to assist 911 operators to provide the most appropriate emergency services. If you do not want to disclose this information, do not switch the feature on.

# Keys and Remote Controls

## GENERAL INFORMATION ON RADIO FREQUENCIES

This device complies with Part 15 of the FCC Rules and with Licence exempt RSS Standards of Industry Canada. Operation is subject to the following two conditions:

- This device may not cause harmful interference, and
- This device must accept any interference received, including interference that may cause undesired operation.



**WARNING:** Changes or modifications not expressly approved by the party responsible for compliance could void the user's authority to operate the equipment. The term "IC:" before the radio certification number only signifies that Industry Canada technical specifications were met.

The typical operating range for your transmitter is approximately 33 ft (10 m). Vehicles with the remote start feature will have a greater range. One of the following could cause a decrease in operating range:

- Weather conditions.
- Nearby radio towers.
- Structures around the vehicle.
- Other vehicles parked next to your vehicle.

Other short distance radio transmissions, for example amateur radios, medical equipment, wireless headphones, remote controls and alarm systems can also use the radio frequency used by your remote control. If the frequencies are jammed, you will not be able to use your remote control. You can lock and unlock the doors with the key.

**Note:** Make sure to lock your vehicle before leaving it unattended.

**Note:** If you are in range, the remote control will operate if you press any button unintentionally.

**Note:** The remote control contains sensitive electrical components. Exposure to moisture or impact may cause permanent damage.

## REMOTE CONTROL - VEHICLES WITH: KEYLESS ENTRY AND PUSH BUTTON START



E272924

The key operates the power locks. The key must be in your vehicle to use the push button start.

**Note:** You may not be able to shift out of park (P) unless the key is inside your vehicle.

### Removable Key Blade

The key also contains a removable key blade that you can use to unlock your vehicle.

# Keys and Remote Controls



E272925

Press the release button and pull the key blade out.



E272925

1. Press the release button and pull the key blade out.



E151795

**Note:** Your vehicle keys came with a security label that provides important key cut information. Keep the label in a safe place for future reference.

## Replacing the Battery

**Note:** Refer to local regulations when disposing of transmitter batteries.

**Note:** Do not wipe off any grease on the battery terminals or on the back surface of the circuit board.

**Note:** Replacing the battery does not erase the programmed key from your vehicle. The transmitter should operate normally.



## Keys and Remote Controls



E218401

2. Twist a thin coin under the tab hidden behind the key blade head to remove the battery cover.



E218402

3. Insert a suitable tool, for example a screwdriver, in the position shown and carefully remove the battery.
4. Install a new battery with the + facing up.
5. Reinstall the battery cover and the key blade.

### Locating Your Vehicle



Press the button twice within three seconds. The horn sounds and the direction indicators flash. We recommend you use this method to locate your vehicle, rather than using the panic alarm.

### Sounding the Panic Alarm

**Note:** *The panic alarm only operates when the ignition is off.*



Press the button to sound the panic alarm. Press the button again or switch the ignition on to switch it off.

# Keys and Remote Controls

## REMOTE CONTROL-VEHICLES WITH: REMOTE FLIP KEY

Use the key blade to start your vehicle and unlock or lock the driver door from outside your vehicle. The buttons on the key operate the remote control function.



E272914

Press the button to release the key blade. Press and hold the button to fold the key blade back in when not in use.



E151795

**Note:** Your vehicle keys came with a security label that provides important key cut information. Keep the label in a safe place for future reference.

## Replacing the Battery

**Note:** Refer to local regulations when disposing of transmitter batteries.

**Note:** Do not wipe off any grease on the battery terminals or on the back surface of the circuit board.

**Note:** Replacing the battery does not erase the programmed key from your vehicle. The transmitter should operate normally.

A message appears in the information display when the remote control battery is low. See **Information Messages** (page 94).

The remote control uses one coin-type three-volt lithium battery CR2032 or equivalent.

Press the button to release the key blade before beginning the procedure.



E272915

1. Insert a suitable tool, for example a screwdriver, in the position shown and gently press the clip.
2. Press the clip down to release the battery cover.

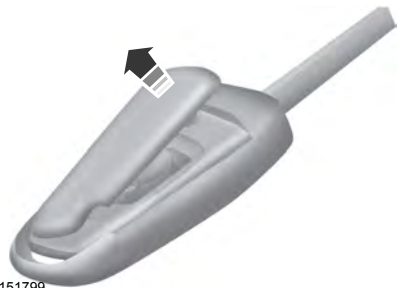

E151799

3. Carefully remove the battery cover.

# Keys and Remote Controls



E151800

**Note:** Do not touch the battery contacts or the printed circuit board with the screwdriver.

4. Insert the screwdriver in the position shown to release the battery.



E151801

5. Remove the battery.
6. Install a new battery with the + facing upward.
7. Reinstall the battery cover.

## Locating Your Vehicle



Press the button twice within three seconds. The horn sounds and the direction indicators flash. We recommend you use this method to locate your vehicle, rather than using the panic alarm.

## Sounding the Panic Alarm

**Note:** The panic alarm only operates when the ignition is off.



Press the button to sound the panic alarm. Press the button again or switch the ignition on to switch it off.

## REPLACING A LOST KEY OR REMOTE CONTROL

You can purchase replacement keys or remote controls from an authorized dealer. Authorized dealers can program remote controls for your vehicle. See **Remote Control** (page 51).

To re-program the passive anti-theft system see an authorized dealer.

## PASSIVE KEY BACKUP POSITION

1. Remove the key blade. See **Remote Control** (page 51).

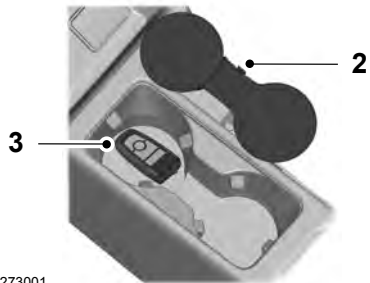

E273001

2. Remove the rubber mat.
3. Place the passive key in the position shown, with the buttons facing upward and the unlock button facing the front of your vehicle.

## PRINCIPLE OF OPERATION

The system is designed to promote good driving behaviors using keys that you have programmed with some restricted settings.

## MYKEY SETTINGS

### Non-Configurable Settings

#### Seatbelt Reminder

The audio system mutes when the seatbelt reminder turns on. The seatbelt reminder cannot be switched off with a MyKey.

#### Early Low Fuel

The low fuel level indicator turns on earlier.

#### Driving and Parking Aids

Parking aids, blind spot information system and cross traffic alert turn on when you start the engine and cannot be switched off with a MyKey.

Pre-collision assist and lane keeping alert turn on when you start the engine, but can be switched off with a MyKey.

A new destination in the navigation system can only be set using voice commands, when using a MyKey and your vehicle is moving.

### Configurable Settings

You can configure the following settings after creating a MyKey. See **Creating a MyKey** (page 57).

### Speed Limit



**WARNING:** Do not set MyKey maximum speed limit to a limit that will prevent the driver from maintaining a safe speed considering posted speed limits and prevailing road conditions. The driver is always responsible to drive in accordance with local laws and prevailing conditions. Failure to do so could result in accident or injury.

You can set a speed limit for your vehicle. Warning messages appear in the information display and a tone sounds if your vehicle reaches the set speed. You cannot override the set speed when using a MyKey.

#### Speed Reminder

You can set a speed reminder for your vehicle. Warning messages appear in the information display and a tone sounds if your vehicle exceeds the set speed.

#### Audio System Volume Limit

The audio system maximum volume is reduced. A message appears in the information display if you attempt to exceed the volume limit. Automatic volume control turns off.

#### Emergency Assistance

If you set emergency assistance to be always on, it cannot be switched off with a MyKey.

#### Do Not Disturb

If you set do not disturb to be always on, it cannot be switched off with a MyKey.

#### Traction Control

If you set traction control to be always on, it cannot be switched off with a MyKey.

## CREATING A MYKEY - VEHICLES WITHOUT: PUSH BUTTON START

Switch the ignition on using an admin key.

**To create a MyKey, use the information display controls on the steering wheel to select the following:**

Menu Item	Action
Settings	Press the menu button.
MyKey	Press the <b>OK</b> button.
Create MyKey	Press and hold the <b>OK</b> button until a confirmation message appears in the information display.
	Switch the ignition off.

**Note:** We recommend that you label this key.

### MyKey Information Messages

Message	Description
Key is Already a MyKey	Displays when trying to create a MyKey with a key already designated as a MyKey.
Hold OK to Create MyKey	Displays when creating a MyKey.
Creation Completed	Displays to confirm that a MyKey has been created.
This Key restricted at Next Key Cycle. Label Key as MyKey	Displays to confirm that the key is restricted after you switch the ignition off.
MyKey not Created	Displays if the system fails to create a MyKey.

2. Switch the ignition on.

## CREATING A MYKEY - VEHICLES WITH: PUSH BUTTON START

1. Place an admin key in the backup position. See **Passive Key Backup Position** (page 55).

# MyKey™

**To create a MyKey, use the information display controls on the steering wheel to select the following:**

Menu Item	Action
Settings	Press the menu button.
MyKey	Press the <b>OK</b> button.
Create MyKey	Press and hold the <b>OK</b> button until a confirmation message appears in the information display.
	Switch the ignition off.

**Note:** We recommend that you label this key.

## MyKey Information Messages

Message	Description
Place Key in Backup Location	Displays when trying to create a MyKey and the key is not placed in the backup position. See <b>Passive Key Backup Position</b> (page 55).
Key is Already a MyKey	Displays when trying to create a MyKey with a key already designated as a MyKey.
Hold OK to Create MyKey	Displays when creating a MyKey.
Creation Completed	Displays to confirm that a MyKey has been created.
This Key restricted at Next Key Cycle. Label Key as MyKey	Displays to confirm that the key is restricted after you switch the ignition off.
MyKey not Created	Displays if the system fails to create a MyKey.

Switch the ignition on using an admin key.

## PROGRAMMING A MYKEY

You can only program MyKeys to the same settings.

# MyKey™

---

**To program a MyKey, use the information display controls on the steering wheel to select the following:**

Menu Item	Action
Settings	Press the menu button.
MyKey	Press the <b>OK</b> button. Choose a setting and press the <b>OK</b> button. Configure the setting. Switch the ignition off.

## CLEARING ALL MYKEYS

When you clear all MyKeys, you remove all

restrictions and return all MyKeys to their original admin key status.

Switch the ignition on using an admin key.

**To clear all MyKeys, use the information display controls on the steering wheel to select the following:**

Menu Item	Action
Settings	Press the menu button.
MyKey	Press the <b>OK</b> button.
Clear MyKeys	Press and hold the <b>OK</b> button until a confirmation message appears in the information display.

## MyKey Information Messages

Message	Description
Hold OK to Clear MyKeys	Displays when clearing all MyKeys.
All MyKeys Cleared	Displays to confirm that all MyKeys have been cleared.

## CHECKING MYKEY SYSTEM STATUS

Switch the ignition on.

**To find information about the distance traveled using a MyKey and also the number of admin keys and MyKeys created for your vehicle, use the information display controls on the steering wheel to select the following:**

Menu Item	Action
Settings	Press the menu button.
MyKey	Press the <b>OK</b> button.
MyKey Info	Press the <b>OK</b> button.



## USING MYKEY WITH REMOTE START SYSTEMS

The system is not compatible with non-Ford remote start systems.

## MYKEY TROUBLESHOOTING- VEHICLES WITHOUT: PUSH BUTTON START

### What is an admin key?

- An admin key is a key that has not been created as a MyKey. See **Creating a MyKey** (page 57).

### Why can I not create a MyKey?

- The key used to switch the ignition on is not an admin key.
- The key used to switch the ignition on is the only admin key. There always has to be at least one admin key.

### Why can I not program a MyKey?

- The key used to switch the ignition on is not an admin key.
- No MyKeys are created. See **Creating a MyKey** (page 57).

### Why can I not clear the MyKeys?

- The key used to switch the ignition on is not an admin key.
- No MyKeys are created. See **Creating a MyKey** (page 57).

### Why does the MyKey distance not accumulate?

- The key used to start the engine is an admin key.
- No MyKeys are created. See **Creating a MyKey** (page 57).
- The MyKeys have been cleared.

## MYKEY TROUBLESHOOTING- VEHICLES WITH: PUSH BUTTON START

### What is an admin key?

- An admin key is a key that has not been created as a MyKey. See **Creating a MyKey** (page 57).

### Why can I not create a MyKey?

- The admin key is not placed in the backup position. See **Passive Key Backup Position** (page 55).
- The key used to switch the ignition on is not an admin key.
- The key used to switch the ignition on is the only admin key. There always has to be at least one admin key.
- The last MyKey was created without switching the ignition off.

### Why can I not program a MyKey?

- The admin key is not inside your vehicle.
- The key used to switch the ignition on is not an admin key.
- No MyKeys are created. See **Creating a MyKey** (page 57).

### Why can I not clear the MyKeys?

- The admin key is not inside your vehicle.
- The key used to switch the ignition on is not an admin key.
- No MyKeys are created. See **Creating a MyKey** (page 57).

## **Why does the MyKey distance not accumulate?**

- The key used to start the engine is an admin key.
- An admin key and a MyKey are inside your vehicle.
- No MyKeys are created. See **Creating a MyKey** (page 57).
- The MyKeys have been cleared.

## **Why can I not start the engine with a MyKey?**

- An admin key and a MyKey are inside your vehicle.

# Doors and Locks

## LOCKING AND UNLOCKING

### Remote Control

You can use the remote control at any time.

### Unlocking the Doors

The position lamps illuminate when you unlock the doors. When you switch the ignition on, they automatically turn off.

**Note:** *You can unlock the driver door with the key. Use the key when the remote control is not functioning.*

**Note:** *When you leave your vehicle unattended for several weeks, the remote control turns off. Your vehicle must be unlocked and the engine started using the key. Unlocking and starting your vehicle once enables the remote control.*

### One-Stage Unlocking



Press the button to unlock all doors. The direction indicators will flash.

### Two-Stage Unlocking



Press the button to unlock the front doors. Press the button again within three seconds to unlock all doors. The direction indicators will flash.

### Reprogramming the Unlocking Function

When you press the unlock button only the driver and passenger doors unlock. Pressing the unlock button again unlocks all doors.

You can reprogram the unlocking function so that all doors unlock when you press the unlock button once.

1. Switch the ignition off.

2. Press and hold both the lock and unlock buttons on the remote control until the direction indicators flash twice to confirm the change.

To return to the original unlocking function, repeat the process.

### Locking the Doors



Press the button to lock all doors. The direction indicators will flash.

Press the button again within three seconds to confirm that all the doors are closed. The doors will lock again, the horn will sound and the direction indicators will flash if all the doors and the liftgate are closed.

**Note:** *If any door or the liftgate is open, or if the hood is open on vehicles with an anti-theft alarm or remote start, the horn does not sound.*

### Locking and Unlocking the Doors From Inside

The power door lock control is on the driver and front passenger door panels.



Press the button to lock or unlock all the doors. The lamp illuminates with the doors locked.

### Opening the Double Rear Doors

**Note:** *If there is a ladder fitted to the rear cargo door, do not open the door fully if the side-loading door is open.*

# Doors and Locks



2. Press the button.
3. Open the cargo door fully.

## Locking and Unlocking the Doors with the Key Blade

**Note:** Do not leave your keys in your vehicle.

### Locking with the Key

Turn the top of the key toward the front of your vehicle.

### Unlocking with the Key

Turn the top of the key toward the rear of your vehicle.

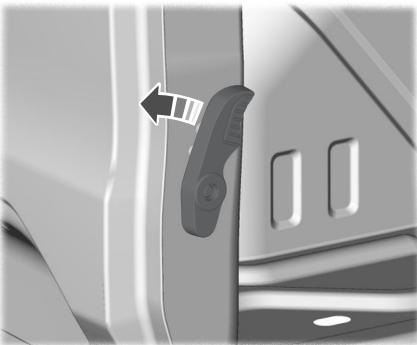

## Unlocking the Doors with the Interior Door Handles

Doors can be unlocked individually by pulling the interior door handles on those doors. Pulling the driver door interior door handle unlocks all the doors, if autounlock has been enabled.

## Rear Door Unlocking and Opening

Pull the interior door handle twice to unlock and open a rear door. The first pull unlocks the door and the second pull opens the door.

## Smart Unlocks for Integrated Keyhead Transmitter

This helps to prevent you from locking yourself out of your vehicle if the key is still in the ignition.

When you open one of the front doors and lock your vehicle with the power door lock control, all the doors will lock then unlock if the key is still in the ignition.

You can still lock your vehicle with the key in the ignition by pressing the lock button on the remote control even if the doors are not closed.

1. Open the rear cargo door.

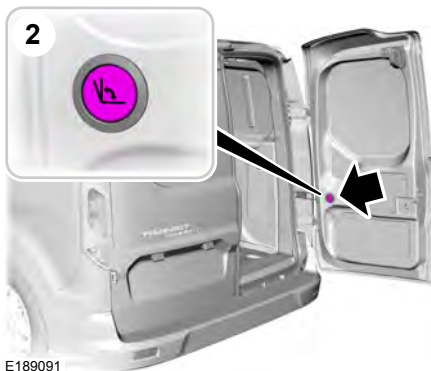

# Doors and Locks

If both front doors are closed, you can lock your vehicle by any method, regardless of whether the key is in the ignition or not.

## Autolock

Autolock locks all the doors and liftgate when all of the following occur:

- All doors are closed.
- The ignition is on.
- Your vehicle is moving at a speed greater than 4 mph (7 km/h) for more than two seconds.

## Autounlock

Autounlock unlocks all the doors when all of the following occur:

- The ignition is on, all doors are closed, and your vehicle is moving at a speed greater than 4 mph (7 km/h) for more than two seconds.
- Your vehicle has come to a stop and you switch the ignition off or to the accessory position.
- The driver door is opened within 10 minutes of you switching the ignition off or to the accessory position.

**Note:** *The doors will not autounlock if your vehicle has been electronically locked after you switch the ignition off and before you open the driver door.*

## Switching Autounlock On or Off

**To switch autounlock on or off, use the information display controls on the steering wheel to select the following:**

Menu Item	Action
Settings	Press the menu button.
Vehicle Settings	Press the <b>OK</b> button.
Locks	Press the <b>OK</b> button.
Autounlock	Press the <b>OK</b> button.

## Emergency Locking with the Key

**Note:** *If the child safety locks are on and you pull the interior handle, you only switch off the emergency locking, not the child safety lock. You can only open the doors using the external door handle.*

**Note:** *When the doors have been unlocked using this method, the doors must be locked individually until the central locking function has been repaired.*

If the central locking function does not operate, lock the doors individually using the key in the position shown.

# Doors and Locks

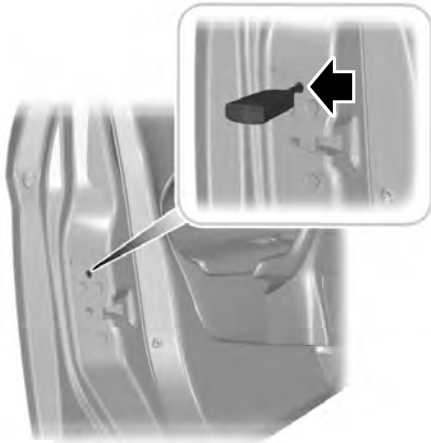

E112203

## Left-Hand Side

Turn clockwise to lock.

## Right-Hand Side

Turn counterclockwise to lock.

## Opening the Double Rear Doors From Inside

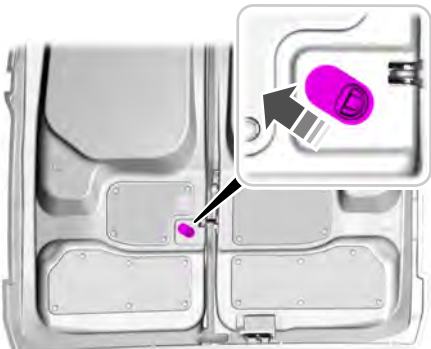

E180300

1. Slide the release lever upward to open the door. If the vehicle is locked, repeat the step.

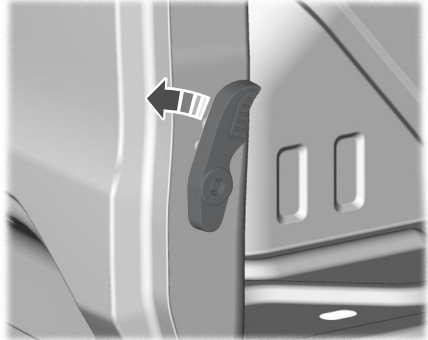

E148806

2. Pull the release lever to open the other door.

## SLIDING DOOR



E145826

When the rear doors are fully open, make sure that you do not step on the cable or mechanism at the base of the door aperture. This could damage the sliding door and its components.

# Doors and Locks

## KEYLESS ENTRY

### General Information

The system will not function if:

- The vehicle battery has no charge.
- The passive key battery has no charge.
- The passive key frequencies are jammed.
- The door handle is not clean.

**Note:** *If the system does not function, you will need to use the key blade to lock and unlock your vehicle.*

The system allows you to operate your vehicle without the use of a key or remote control.

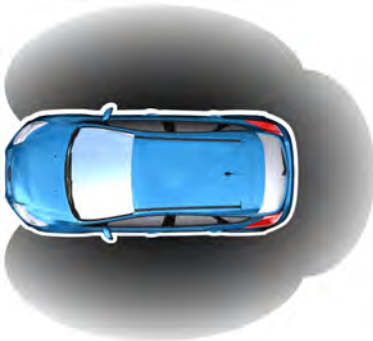

E78276

Passive locking and unlocking requires a valid passive key to be located within one of the three external detection ranges. These are located approximately 5 ft (1.5 m) from the front door handles and the liftgate.

**Note:** *The system may not function if the passive key is close to metal objects or electronic devices, for example keys or a cell phone.*

## Passive Key

Your vehicle can be locked and unlocked using the passive key. You can also use the passive key as a remote control to lock and unlock your vehicle. See **Locking and Unlocking** (page 63).

## Locking Your Vehicle

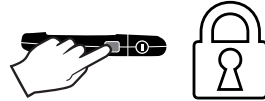

E248556

The locking sensors are on the front door handles.

Touch a locking sensor once to lock your vehicle and arm the alarm.

For vehicles with double locking, touch a locking sensor twice within three seconds to double lock your vehicle and arm the alarm.

**Note:** *When locking your vehicle, do not grip the door handle.*

**Note:** *Your vehicle remains locked for approximately one second. When the delay period is over, you can open the doors again, provided the passive key is within the respective detection range.*

**Note:** *Your vehicle does not automatically lock. If you do not touch a locking sensor your vehicle remains unlocked.*

Two short flashes of the direction indicators confirms that all the doors and the liftgate have been locked and that the alarm has been armed.

## At the Liftgate

The liftgate cannot be closed and will reopen if the passive key is located inside the luggage compartment with the doors locked.

# Doors and Locks

**Note:** If a second valid passive key is located within the liftgate detection range, the liftgate can be closed.

## Unlocking Your Vehicle



E248555

Pull a front exterior door handle to unlock and open the door. Do not touch the lock sensor on the front of the handle.

One long flash of the direction indicators confirms that all the doors and the liftgate have been unlocked and that the alarm has been disarmed.

**Note:** A valid passive key must be located within the detection range of that door.

## Unlocking Only the Driver's Door

You can program the system so that only the driver door is unlocked. See **Locking and Unlocking** (page 63).

If you program the unlocking function so that only the driver door unlocks, the following occurs:

- If the driver's door is the first door which is opened, the other doors will remain locked. All the other doors can be unlocked from inside your vehicle by pressing the unlock button located on the driver's and front passenger's door. You can unlock individual doors by pulling the interior door handles on those doors.
- If the front passenger's door is the first door which is opened, all the doors and the liftgate will be unlocked.

## Disabled Keys

Any keys left inside your vehicle interior when it is locked will be disabled.

You cannot use a disabled key to switch the ignition on or start the engine.

You must enable all passive keys again in order to use them. To enable all your passive keys, unlock your vehicle using a passive key that has not been disabled or the remote control unlocking function. All passive keys will then be enabled if you switch the ignition on or you start your vehicle with a valid key.

**Note:** You can still start your vehicle when the passive key is in the back-up position. See **Push Button Ignition Switch** (page 135).

## Locking and Unlocking the Doors with the Key Blade



E272923

Push the release button and pull the key blade out.

**Note:** Only the driver door handle has a lock cylinder.



# Liftgate

## MANUAL LIFTGATE



**WARNING:** It is extremely dangerous to ride in a cargo area, inside or outside of a vehicle. In a crash, people riding in these areas are more likely to be seriously injured or killed. Do not allow people to ride in any area of your vehicle that is not equipped with seats and seatbelts. Make sure everyone in your vehicle is in a seat and properly using a seatbelt. Failure to follow this warning could result in serious personal injury or death.



**WARNING:** Make sure to close and latch the liftgate to prevent drawing exhaust fumes into your vehicle. This will also prevent passengers and cargo from falling out. If you must drive with the liftgate open, keep the vents or windows open so outside air comes into your vehicle. Failure to follow this warning could result in serious personal injury.

**Note:** *Be careful when opening or closing the liftgate in a garage or other enclosed area to avoid damaging the liftgate.*

**Note:** *Do not hang anything, for example a bike rack, from the glass or liftgate. This could damage the liftgate and its components.*

## Unlocking the Liftgate



Press the button on the remote control.

## Opening the Liftgate

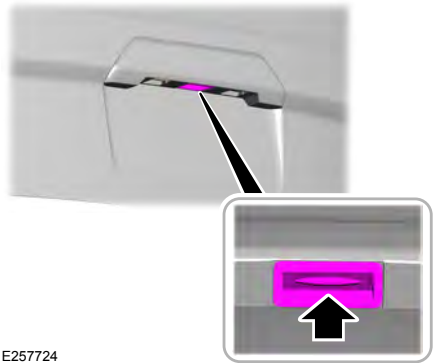

E257724

Press the exterior release button hidden above the license plate.

## Closing the Liftgate

Pull the strap inside the liftgate to help with closing.

# Security

---

## PASSIVE ANTI-THEFT SYSTEM

**Note:** *The system is not compatible with non-Ford aftermarket remote start systems. Use of these systems may result in vehicle starting problems and a loss of security protection.*

**Note:** *Metallic objects, electronic devices or a second programmed key on the same key chain may cause vehicle starting problems if they are too close to the key when starting the engine. Prevent these objects from touching the programmed key while starting the engine. Switch the ignition off, move all objects on the key chain away from the programmed key and restart the engine if a problem occurs.*

**Note:** *Do not leave a duplicate programmed key in your vehicle. Always take your keys and lock all doors when leaving your vehicle.*

### SecuriLock®

The system is an engine immobilization system. It is designed to help prevent the engine from being started unless a programmed key for your vehicle is used. Using an incorrectly programmed key may prevent the engine from starting. A message may appear in the information display.

If you are unable to start the engine with a programmed key, a malfunction has happened and a message may appear in the information display.

### Automatic Arming

The engine immobilization system arms immediately after you switch the ignition off.

### Automatic Disarming

Switching the ignition on with a programmed key disarms the engine immobilization system.

### Replacement Keys

If your keys are lost or stolen and you do not have a spare programmed key, you will need to have your vehicle towed to an authorized dealer. You need to erase the programmed keys from your vehicle and program new keys.

Store an extra programmed key away from your vehicle in a safe place to help prevent any inconveniences. We recommend that you contact an authorized dealer to purchase additional spare or replacement keys.

**Note:** *Your vehicle comes with two keys.*

### Programming a Remote Flip Key

The procedure programs both the vehicle immobilizer keycode and the remote entry portion of the remote control to your vehicle.

To program a new key, you require two programmed keys and one unprogrammed key with you in your vehicle.

We recommend that you contact an authorized dealer to have the key programmed if you do not have two programmed keys.

Make sure that you complete the procedure within 30 seconds.

Stop and wait for at least one minute before you start again if you miss a step.

**Note:** *You can program a maximum of six keys to your vehicle.*

Read the entire procedure before you begin.

1. Close all the doors.

# Security

**Note:** *Keep the doors closed throughout the procedure.*

2. Switch the ignition off.

**Note:** *Do not press the brake pedal or accelerator pedal throughout the procedure.*

3. Insert the first programmed key into the ignition.
4. Switch the ignition on.
5. Wait five seconds.
6. Switch the ignition off and remove the key from the ignition.
7. Within 10 seconds, insert the second programmed key into the ignition.
8. Switch the ignition on.
9. Wait five seconds.
10. Switch the ignition off and remove the key from the ignition.
11. Within 10 seconds, insert the unprogrammed key into the ignition.
12. Switch the ignition on.
13. Wait five seconds.
14. Switch the ignition off and remove the key from the ignition.

Check that the remote control functions operate and your vehicle starts with the new key.

**Note:** *Wait 10 seconds and repeat the procedure if the remote control functions do not operate and you cannot start the engine.*

Wait 20 seconds and repeat the procedure to program an additional key.

## Programming a Passive Key

The procedure programs both the vehicle immobilizer keycode and the remote entry portion of the remote control to your vehicle.

To program a new key, you require two programmed keys and one unprogrammed key with you in your vehicle.

We recommend that you contact an authorized dealer to have the key programmed if you do not have two programmed keys.

Make sure that you complete the procedure within 30 seconds.

Stop and wait for at least one minute before you start again if you miss a step.

**Note:** *You can program a maximum of four keys to your vehicle.*

Read the entire procedure before you begin.

1. Close all the doors.

**Note:** *Keep the doors closed throughout the procedure.*

2. Switch the ignition off.

**Note:** *Do not press the brake pedal or accelerator throughout the procedure.*

3. Remove the key blade. See **Remote Control** (page 51).

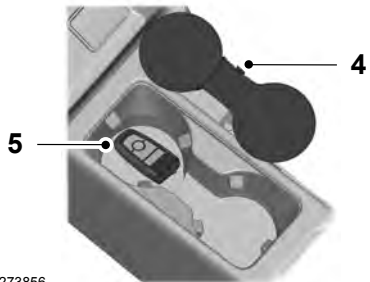

E273856

4. Remove the rubber mat from the cup holder.
5. Place the first programmed key in the backup position with the buttons facing upward and the unlock button facing the front of your vehicle.

# Security

6. Press the push button ignition switch.
7. Wait five seconds.
8. Press the push button ignition switch.
9. Remove the key.
10. Within 10 seconds, place the second programmed key in the backup position.
11. Press the push button ignition switch.
12. Wait five seconds.
13. Press the push button ignition switch.
14. Remove the key.
15. Within 10 seconds, place the unprogrammed key in the backup position.
16. Press the push button ignition switch.

Check that the remote control function operate with the new key.

**Note:** *Wait 10 seconds and repeat the procedure if the key functions do not operate.*

Wait 20 seconds and repeat the procedure to program an additional key.

## ANTI-THEFT ALARM

### Alarm System

The perimeter alarm is a deterrent against unauthorized access to your vehicle through the doors, luggage compartment and the hood. It also protects the audio unit.

### Triggering the Alarm

Once armed, the alarm is triggered in any of the following ways:

- If someone opens a door, luggage compartment or the hood without a valid key or remote control.
- If someone removes the audio or navigation system.
- If you switch the ignition on without a valid key.

If the alarm is triggered, the horn will sound for 30 seconds and the hazard warning flasher will flash for five minutes.

Any further attempts to perform one of the above will trigger the alarm again.

## Full Guard and Reduced Guard

### Full Guard

Full guard is the standard setting.

In full guard, the interior sensors are on when you arm the alarm.

**Note:** *Do not arm the alarm with full guard if passengers, animals or other moving objects are inside your vehicle.*

### Reduced Guard

In reduced guard, the interior sensors are off when you arm the alarm.

### Selecting Full or Reduced Guard

You can select full or reduced guard using the information display. See **General Information** (page 92).

### Ask on Exit

If you switch ask on exit on, you can choose which level of guard you require after you switch the ignition off.

### Arming the Alarm

To arm the alarm, lock your vehicle. See **Doors and Locks** (page 63).

# Security

---

## **Disarming the Alarm**

Disarm and silence the alarm by unlocking the doors with the key and switching the ignition on with a correctly coded key within 12 seconds, or by unlocking the doors or the luggage compartment with the remote control.

# Steering Wheel

## ADJUSTING THE STEERING WHEEL



**WARNING:** Do not adjust the steering wheel when your vehicle is moving.

**Note:** Make sure that you are sitting in the correct position. See **Sitting in the Correct Position** (page 115).



E95178

1. Unlock the steering column.
2. Adjust the steering wheel to the desired position.



E95179

3. Lock the steering column.

# Wipers and Washers

## WINDSHIELD WIPERS

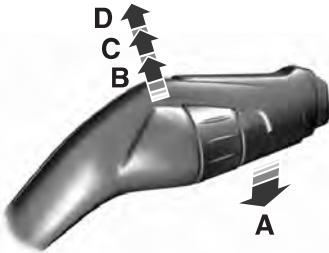

E197525

- A Single wipe.
- B Intermittent wipe.
- C Normal wipe.
- D High-speed wipe.

**Note:** Fully defrost the windshield before you switch the windshield wipers on.

**Note:** Make sure that you switch the windshield wipers off before entering a car wash.

**Note:** If streaks or smears appear on the windshield, clean the windshield and the wiper blades. See **Checking the Wiper Blades** (page 275). If that does not resolve the issue, install new wiper blades. See **Changing the Front Wiper Blades** (page 275).

**Note:** Do not operate the wipers on a dry windshield. This may scratch the glass or damage the wiper blades. Always use the windshield washers before wiping a dry windshield.

## Intermittent Wipe

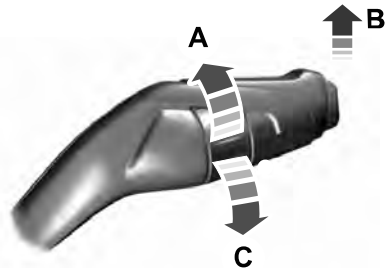

E197526

- A Short wipe interval.
- B Intermittent wipe.
- C Long wipe interval.

Use the rotary control to adjust the intermittent wipe interval.

**Note:** The wipers remain in a slightly raised position during operation and only return to the park position when you switch intermittent wipe off.

## Speed Dependent Wipers (If Equipped)

When your vehicle speed increases, the interval between wipes decreases.

## AUTOWIPERS

Autowipers uses a rain sensor in the area around the interior mirror. The wipers operate when the rain sensor detects water on the windshield in front of it. The rain sensor continues to monitor the amount of water and adjusts the speed of the wipers.

**Note:** The wipers remain in a slightly raised position during operation and only return to the park position a short time after the rain sensor detects no water on the windshield.

# Wipers and Washers

You can switch autowipers off in the information display. If you switch autowipers off, the windshield wipers operate in intermittent mode.

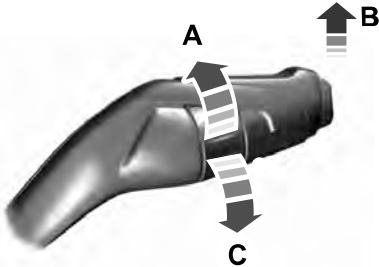

E197526

- A High sensitivity.
- B Autowipers on.
- C Low sensitivity.

Move the wiper lever upward to the first position to switch autowipers on.

Use the rotary control to adjust the sensitivity of the autowipers. When you select low sensitivity, the wipers operate when the sensor detects a large amount of water on the windshield. When you select high sensitivity, the wipers operate when the sensor detects a small amount of water on the windshield.

**Note:** Keep the outside of the windshield clean. The rain sensor is very sensitive and the wipers may operate if dirt, mist or insects hit the windshield.

If you leave autowipers on, it may not operate when you switch the ignition on during freezing temperatures. This is because the system has deactivated the rain sensor to prevent damage to the windshield wipers. Defrost the windshield before reactivating the rain sensor. You can reactivate the rain sensor by moving the rotary control or switching autowipers off and on.

**Note:** Fully defrost the windshield before you switch the windshield wipers on.

**Note:** Make sure that you switch the windshield wipers off before entering a car wash.

Wet or winter weather conditions could cause unexpected wiping or smearing.

To keep the windshield clear:

- Lower the sensitivity of the autowipers to reduce the amount of smearing on the windshield.
- Switch autowipers off.

**Note:** If streaks or smears appear on the windshield, clean the windshield and the wiper blades. If that does not resolve the issue, install new wiper blades. See **Changing the Front Wiper Blades** (page 275).

## WINDSHIELD WASHERS



E144498

Pull the lever toward you to operate the windshield washers. When you release the lever, the wipers operate for a short time.

**Note:** Do not operate the washers when the washer reservoir is empty. This may cause the washer pump to overheat.



# Wipers and Washers

## REAR WINDOW WIPER AND WASHERS

### Rear Window Wiper



E171615

- A Intermittent wipe.
- B Continuous wipe.
- C Rear window wiper off.

Press the top of the button to switch intermittent wipe on. Press the top of the button again to switch continuous wipe on. Press the bottom of the button to switch the rear window wiper off.

**Note:** Make sure you switch the rear window wiper off before entering a car wash.

### Reverse Gear Wipe (If Equipped)

If you shift to reverse (R) when the windshield wipers are on, the rear window wiper turns on.

### Rear Window Washer

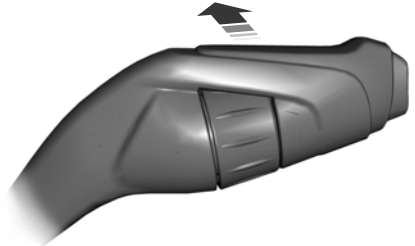

E167407

Push the lever away from you to operate the rear window washer. When you release the lever, the wipers operate for a short time.

# Lighting

## GENERAL INFORMATION

### Condensation in the Exterior Front Lamps and Rear Lamps

Exterior front lamps and rear lamps have vents to accommodate normal changes in air pressure.

Condensation can be a natural by-product of this design. When moist air enters the lamp assembly through the vents, there is a possibility that condensation can occur when the temperature is cold. When normal condensation occurs, a fine mist can form on the interior of the lens. The fine mist eventually clears and exits through the vents during normal operation.

Clearing time may take as long as 48 hours under dry weather conditions.

Examples of acceptable condensation are:

- The presence of a fine mist (no streaks, drip marks or large droplets).
- A fine mist covers less than 50% of the lens.

Examples of unacceptable condensation are:

- A water puddle inside the lamp.
- Streaks, drip marks or large droplets present on the interior of the lens.

If you see any unacceptable condensation, have your vehicle checked by an authorized dealer.

## LIGHTING CONTROL

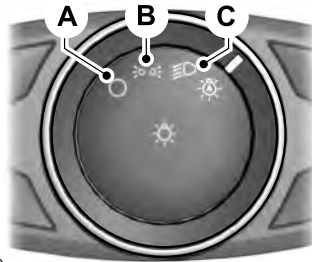

E142449

- A Off.
- B Parking lamps, instrument panel lamps, license plate lamps and tail lamps.
- C Headlamps.

### Parking Lamps

**Note:** Prolonged use of the parking lamps will cause the battery to run out of charge.

**Note:** Parking lamps may turn off automatically. This prevents the vehicle battery from running out of charge.

Switch the ignition off.

Select position B on the lighting control to switch the parking lamps on.

### High Beams



E163718

# Lighting

Push the lever away from you to switch the high beam on.

Push the lever forward again or pull the lever toward you to switch the high beams off.

## Headlamp Flasher



E163719

Slightly pull the lever toward you and release it to flash the headlamps.

## AUTOLAMPS (If Equipped)



**WARNING:** The system does not relieve you of your responsibility to drive with due care and attention. You may need to override the system if it does not turn the headlamps on in low visibility conditions, for example daytime fog.

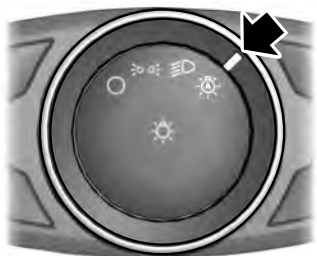

E142451

When the lighting control is in the autolamps position, the headlamps turn on in low light situations, or when the wipers turn on.

The headlamps remain on for a period of time after you switch the ignition off. Use the information display controls to adjust the period of time that the headlamps remain on.

**Note:** If you switch the autolamps on, you cannot switch the high beams on until the system turns the low beams on.

## Windshield Wiper Activated Headlamps

When you switch the autolamps on, the headlamps turn on within 10 seconds of switching the wipers on. They turn off approximately 60 seconds after you switch the windshield wipers off.

The headlamps do not turn on with the wipers:

- During a single wipe.
- When using the windshield washers.
- If the wipers are in intermittent mode.

**Note:** If you switch the autolamps and the autowipers on, the headlamps turn on when the windshield wipers continuously operate.

## INSTRUMENT LIGHTING DIMMER

The instrument lighting dimmer buttons are on the lighting control.



Repeatedly press one of the buttons to adjust the brightness.

**Note:** If you disconnect or replace the battery, reset the brightness when the battery is reconnected.

# Lighting

## HEADLAMP EXIT DELAY

After you switch the ignition off, you can switch the headlamps on by pulling the direction indicator lever toward you. You will hear a short tone. The headlamps will switch off automatically after three minutes with any door open or 30 seconds after the last door has been closed. You can cancel this feature by pulling the direction indicator toward you again or switching the ignition on.

## AUTOMATIC HIGH BEAM CONTROL



**WARNING:** The system does not relieve you of your responsibility to drive with due care and attention. You may need to override the system if it does not turn the high beams on or off.

The system turns on high beams if it is dark enough and no other traffic is present. If it detects an approaching vehicle's headlamps or tail lamps, or street lighting ahead, the system turns off high beams before they can distract other road users. Low beams remain on.

**Note:** *The system may not operate properly if the sensor is blocked. Keep the windshield free from obstruction or damage.*

**Note:** *The system may not operate properly in cold or inclement conditions. You can switch on the high beams by overriding the system.*

**Note:** *If the system detects a blockage, for example bird droppings, bug splatter, snow or ice, the system goes into low beam mode until you clear the blockage. A message may appear in the information display if the camera is blocked.*

**Note:** *Using much larger tires or equipping vehicle accessories such as snowplows can modify your vehicle's ride height and degrade automatic high beam control performance.*

A camera sensor, centrally mounted behind the windshield of your vehicle, continuously monitors conditions to turn the high beams on and off.

Once the system is active, the high beams turn on if:

- The ambient light level is low enough.
- There is no traffic in front of your vehicle.
- The vehicle speed is greater than approximately 32 mph (51 km/h).

The system turns the high beams off if:

- The ambient light level is high enough that high beams are not required.
- The system detects an approaching vehicle's headlamps or tail lamps.
- The vehicle speed falls below approximately 27 mph (44 km/h).
- The system detects severe rain, snow or fog.
- The camera is blocked.

## Switching the System On and Off

Switch the system on using the information display. See **Information Displays** (page 92).

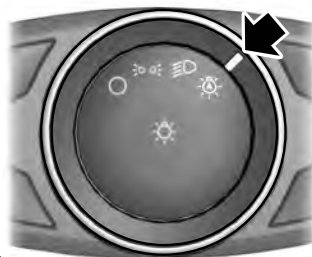

E142451

# Lighting

Switch the lighting control to the autolamps position. See **Autolamps** (page 79).

## Overriding the System

Push the lever away from you to switch between high beam and low beam.

## Automatic High Beam Indicator (if Equipped)



The indicator illuminates to confirm when the system is ready to assist.

## FRONT FOG LAMPS

Only switch the front fog lamps on during reduced visibility.

You can switch the front fog lamps on when the lighting control is in any position except off.

If you switch the autolamps on, you can only switch the front fog lamps on when the headlamps are on.

The front fog lamps button is on the lighting control.



Press the button to switch the front fog lamps on and off.

## CORNERING LAMPS

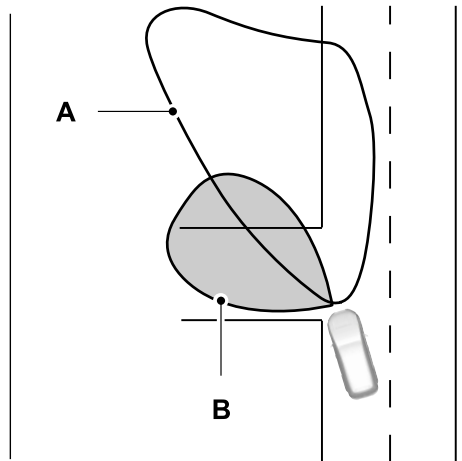
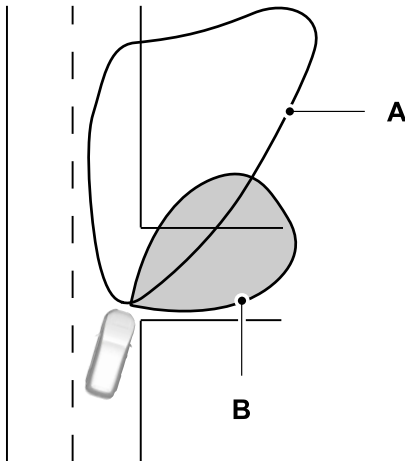

E72898

- A Headlamp beam.
- B Cornering lamp beam.

The cornering lamps illuminate the inside of a corner when you are turning the steering wheel.

# Lighting

## DIRECTION INDICATORS



E162681

Push the lever up or down to use the direction indicators.

**Note:** Tap the lever up or down to make the direction indicators flash three times to indicate a lane change.

## INTERIOR LAMPS

### Courtesy Lamp

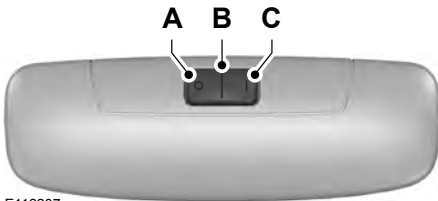

E112207

- A Off
- B Door contact
- C On

If you set the switch to position B, the courtesy lamp will switch on when you unlock your vehicle, open a door or the liftgate. If you leave a door open with the ignition switched off, the courtesy lamp will switch off automatically after a short period of time to prevent your vehicle battery from losing charge. To switch it back on, switch the ignition on for a short period of time.

The courtesy lamp will also switch on when you switch the ignition off. It will switch off automatically after a short period of time or when you start the engine.

If you set the switch to position C with the ignition switched off, the courtesy lamp will switch on. It will switch off automatically after a short period of time to prevent your vehicle battery from losing charge. To switch it back on, switch the ignition on for a short period of time.

### Reading Lamps



E112208

If you switch the ignition off, the reading lamps will switch off automatically after a short period of time to prevent your vehicle battery from losing charge. To switch them back on, switch the ignition on for a short period of time.

# Windows and Mirrors

## POWER WINDOWS - VEHICLES WITH: REAR POWER WINDOWS



**WARNING:** Do not leave children unattended in your vehicle and do not let them play with the power windows. Failure to follow this instruction could result in personal injury.



**WARNING:** When closing the power windows, verify they are free of obstruction and make sure that children and pets are not in the proximity of the window openings.



Press the control to open the window. Lift the control to close the window.

**Note:** *The power windows operate with the ignition on, and for several minutes after you switch the ignition off or until you open a front door.*

To reduce wind noise or pulsing noise when just one window is open, slightly open the opposite window.

### One-Touch Open (If Equipped)

Fully press the control and release it. Press again or lift it to stop the window.

### One-Touch Close (If Equipped)

Fully lift the control and release it. Press again or lift it to stop the window.

### Resetting One-Touch Close

Start the engine.

1. Lift and hold the control until you fully close the window. Continue to hold the control for a few seconds after you close the window.

2. Release the control.
3. Press and hold the control until you fully open the window.
4. Release the control.
5. Lift and hold the control until you fully close the window.
6. Test for correct window operation by opening and closing the windows using one-touch.

### Bounce-Back

The window stops and reverses if it detects an obstruction.

### Overriding Bounce-Back



**WARNING:** If you override bounce-back, the window does not reverse if it detects an obstacle. Take care when closing the windows to avoid personal injury or damage to your vehicle.

1. Close the window until it reaches the point of resistance and let it reverse.
2. Lift the control within a few seconds to override bounce-back and close the window. Bounce-back is now disabled and you can close the window manually.

**Note:** *The window goes past the point of resistance and you can fully close it.*

**Note:** *If the window does not close, have your vehicle checked as soon as possible.*

### Rear Window Lock



Press the control to lock or unlock the rear window controls. It illuminates when you lock the rear window controls.

# Windows and Mirrors

## POWER WINDOWS - VEHICLES WITH: ONE-TOUCH OPEN DRIVER WINDOW



**WARNING:** Do not leave children unattended in your vehicle and do not let them play with the power windows. Failure to follow this instruction could result in personal injury.



**WARNING:** When closing the power windows, verify they are free of obstruction and make sure that children and pets are not in the proximity of the window openings.



Press the control to open the window. Lift the control to close the window.

**Note:** The power windows operate with the ignition on, and for several minutes after you switch the ignition off or until you open a front door.

To reduce wind noise or pulsing noise when just one window is open, slightly open the opposite window.

### One-Touch Open (If Equipped)

Fully press the control and release it. Press again or lift it to stop the window.

## GLOBAL OPENING

1. Press and release the unlock button on the remote control.
2. Press and hold the unlock button on the remote control.
3. Release the button when the windows start to open.

Press the lock or the unlock button on the remote control to stop global opening.

**Note:** You can use global opening for a short period of time when you unlock your vehicle using the remote control.

## EXTERIOR MIRRORS

### Adjusting the Mirrors



**WARNING:** Do not adjust the mirrors when your vehicle is moving. This could result in the loss of control of your vehicle, serious personal injury or death.

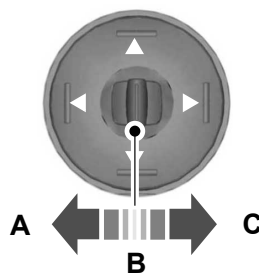

E70846

- A Left-hand mirror switch.
- B Mirror adjustment control.
- C Right-hand mirror switch.

### Folding the Mirrors

#### Vehicles with Manual Fold

Push the mirror toward the door window glass.

Make sure that you fully engage the mirror in its support when returning it to its original position.



# Windows and Mirrors

## Vehicles with Auto-fold

The exterior mirrors fold when you lock your vehicle and unfold when you unlock your vehicle.



For tight parking conditions, press the control to fold the mirrors.

Press the control again to unfold the mirrors.

If you press the control to fold in the mirrors with auto-fold on, the mirrors do not unfold when you unlock your vehicle.

You can switch auto-fold on or off in the information display. See **General Information** (page 92).

**Note:** *The power folding mirrors operate with the ignition on, and for several minutes after you switch the ignition off.*

**Note:** *If you fold and unfold the mirrors several times within one minute, the power fold function may turn off to protect the motors from overheating.*

## INTERIOR MIRROR - VEHICLES WITHOUT: AUTO-DIMMING INTERIOR MIRROR



**WARNING:** Do not adjust the mirrors when your vehicle is moving. This could result in the loss of control of your vehicle, serious personal injury or death.

Pull the tab below the mirror toward you to reduce the effect of bright light from behind.

## INTERIOR MIRROR - VEHICLES WITH: AUTO-DIMMING INTERIOR MIRROR



**WARNING:** Do not adjust the mirrors when your vehicle is moving. This could result in the loss of control of your vehicle, serious personal injury or death.

The mirror dims to reduce the effect of bright light from behind. It returns to normal when the bright light from behind is no longer present or if you shift into reverse (R).

Do not block the sensors on the front and back of the mirror.

**Note:** *A rear center passenger or raised rear center head restraint could prevent light from reaching the sensor.*

## SUN SHADES



**WARNING:** Do not let children play with the sun shade or leave them unattended in the vehicle. They may seriously hurt themselves.



**WARNING:** When closing the sun shade, you should verify that it is free of obstructions and make sure that children and pets are not in the proximity of the sunshade.

The control is located in the overhead console.

The sun shade has a one-touch open and close feature. To stop motion during one-touch operation, press the control a second time.

# Windows and Mirrors

## Opening and Closing the Sun Shade



E223717

Fully press and release the front of the control to open the sun shade.

Fully press and release the rear of the control to close the sun shade.

## Bounce-Back

The sun shade will stop automatically while closing. It will reverse some distance if there is an obstacle in the way.

## Sun Shade Relearning



**WARNING:** The bounce-back function is not active during this procedure. Make sure that there are no obstacles in the way of the moving sun shade.

**Note:** You must start the relearning process within 30 seconds of switching the ignition on.

In case the sun shade no longer opens or closes properly, follow this relearning procedure:

1. Press the front of the control to the first action point twice and release it within two seconds.

2. Press the rear of the control to the first action point twice and release it within two seconds.
3. Press and hold the front of the control to the first action point, until the sun shade fully opens.
4. Press and hold the rear of the control to the first action point, until the sun shade fully closes.

If you do not complete Step 2 within 15 seconds of Step 1, the relearning function end. Switch the ignition off, wait for another 30 seconds and then switch the ignition back on again. Start the procedure again from the beginning.

Confirm that relearning was successful by opening and closing the sun shade.

# Instrument Cluster

## GAUGES

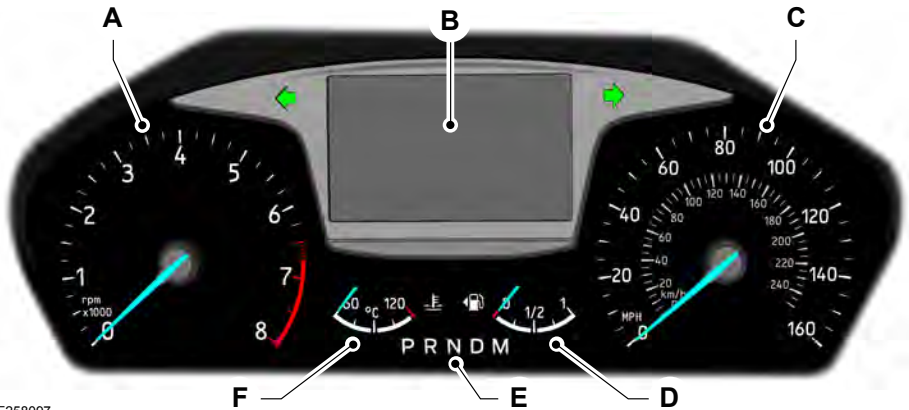

E258097

- A Tachometer.
- B Information display.
- C Speedometer.
- D Fuel gauge.
- E Automatic transmission gearshift lever position indicator.
- F Engine coolant temperature gauge.

## Information Display

### Odometer

Records the total distance traveled by your vehicle.

The system detects unauthorized odometer adjustments to avoid total distance reading fraud. If the system detects an unauthorized odometer adjustment, the total distance reading displays XXXX. Recovery of the original mileage could result in system damage not covered by the vehicle Warranty and may carry a significant expense.

### Trip Computer

See **Trip Computer** (page 94).

### Vehicle Settings and Personalization

See **Personalized Settings** (page 94).

### Fuel Gauge

The fuel gauge indicates approximately how much fuel is in the fuel tank.

The arrow adjacent to the fuel pump symbol indicates on which side of your vehicle the fuel filler door is located.

# Instrument Cluster



A



B

E236403

- A The fuel filler door is on the left-hand side of your vehicle.
- B The fuel filler door is on the right-hand side of your vehicle.

## Engine Coolant Temperature Gauge

At normal operating temperature, the needle remains in the center section. If the needle enters the red section, the engine is overheating. Stop your vehicle as soon as it is safe to do so, switch the engine off and allow it to cool.

**Note:** *The system reduces the engine speed if you continue to operate the engine at a high engine speed.*

**Note:** *Do not restart the engine until the cause of overheating has been determined and resolved.*

## WARNING LAMPS AND INDICATORS

The following warning lamps and indicators alert you to a vehicle condition that may become serious. Some lamps illuminate when you start your vehicle to make sure they work. If any lamps remain on after starting your vehicle, refer to the respective system warning lamp for further information.

**Note:** *Some warning indicators appear in the information display and operate the same as a warning lamp but do not illuminate when you start your vehicle.*

### Adaptive Cruise Control Indicator



It illuminates when you switch the system on.

It illuminates white when the system is in standby mode. It illuminates green when you set the adaptive cruise speed.

### Airbag Warning Lamp



If it does not illuminate when you switch the ignition on, continues to flash or remains on when the engine is running, this indicates a malfunction. Have your vehicle checked as soon as possible.

### Anti-Lock Brake System Warning Lamp



If it illuminates when you are driving, this indicates a malfunction. Your vehicle continues to have normal braking without the anti-lock brake system function. Have your vehicle checked as soon as possible.

### Blind Spot Information System Indicator



It illuminates when you switch the system off. See **Blind Spot Information System** (page 209).

# Instrument Cluster

## Brake System Warning Lamp



**WARNING:** Driving your vehicle with the warning lamp on is dangerous. A significant decrease in braking performance may occur. It may take you longer to stop your vehicle. Have your vehicle checked as soon as possible. Driving extended distances with the parking brake engaged can cause brake failure and the risk of personal injury.



It illuminates when you engage the parking brake and the ignition is on.



If it illuminates when your vehicle is moving, make sure the parking brake is disengaged. If the parking brake is disengaged, this indicates low brake fluid level or a brake system fault. Have your vehicle checked as soon as possible.

## Cruise Control Indicator



It illuminates when you switch the system on. See **Using Cruise Control** (page 195).

## Direction Indicator



It flashes when you switch the direction indicators on.

**Note:** An increase in the rate of flashing warns of a failed indicator bulb.

## Engine Coolant Temperature Warning Lamp



It illuminates if the system has malfunctioned. Have your vehicle checked as soon as possible.

## Engine Warning Lamps



Service Engine Soon

If it illuminates when the engine is running this indicates a malfunction.

If it flashes when you are driving, reduce the speed of your vehicle immediately. Avoid heavy acceleration and deceleration and have your vehicle checked as soon as possible.



Malfunction Indicator Lamp

If it illuminates when the engine is running this indicates a malfunction. The On Board Diagnostics system has detected a malfunction of the vehicle emission control system.

If it flashes, engine misfire may be occurring. Increased exhaust gas temperatures could damage the catalytic converter or other vehicle components. Avoid heavy acceleration and deceleration and have your vehicle checked as soon as possible.

If both lamps illuminate when the engine is running, stop your vehicle as soon as it is safe to do so. Continuing to drive your vehicle may cause reduced power or the engine to stop. Switch the ignition off and attempt to restart the engine. Have your vehicle checked as soon as possible.

## Fasten Seatbelt Warning Lamp



It illuminates to remind you to fasten your seatbelt. See **Seatbelt Reminder** (page 36).

## Front Fog Lamp Indicator



It illuminates when you switch the front fog lamps on.

# Instrument Cluster

## Hazard Flashers Warning Lamp



It flashes when you switch the hazard flashers on.

## High Beam Headlamp Indicator



It illuminates when you switch the high beam headlamps on.

## Ignition Warning Lamp



It illuminates when you switch the ignition on.

If it illuminates when the engine is running this indicates a malfunction. Have your vehicle checked as soon as possible.

## Information Message Indicator



It illuminates to supplement some information messages.

The indicator is red or amber depending on the severity of the condition and it remains on until the condition is resolved.

## Lamps on Indicator



It illuminates when you switch the low beam headlamps or the parking lamps on.

## Low Fuel Level Warning Lamp



It illuminates when the fuel level is low or the fuel tank is nearly empty. Refuel as soon as possible.

## Low Tire Pressure Warning Lamp



It illuminates if one or more tires on your vehicle has low tire pressure. See **Tire Pressure Monitoring System** (page 316).

## Oil Pressure Warning Lamp



It illuminates when you switch the ignition on.

If it illuminates when the engine is running this indicates a malfunction. Stop your vehicle as soon as it is safe to do so and switch the engine off. Check the engine oil level. If the oil level is sufficient, this indicates a system malfunction. Have your vehicle checked as soon as possible.

See **Engine Oil Check** (page 266).

## Stability Control and Traction Control Indicator



Flashes during operation.

If it does not illuminate when you switch the ignition on, or remains on when the engine is running, this indicates a malfunction. Have your vehicle checked as soon as possible.

## Stability Control and Traction Control Off Warning Lamp



It illuminates when you switch the system off.

## AUDIBLE WARNINGS AND INDICATORS

### Airbag Secondary Warning Audible Warning

Sounds when the airbag warning lamp is not working.

### Automatic Transmission Audible Warning

Sounds when you have not moved the transmission selector lever to park. A message will be shown in the display.

# Instrument Cluster

---

## **Door Ajar Audible Warning**

Sounds when a door is not fully closed and your vehicle is moving.

## **Fasten Seatbelt Audible Warning**

Sounds when a seatbelt is unfastened in an occupied seat and your vehicle is moving.

## **Key in Ignition Audible Warning**

Sounds when you open the driver's door and you have left the key in the ignition.

## **Headlamps On Audible Warning**

Sounds when you remove the key from the ignition and open the driver door and you have left the headlamps or parking lamps on.

## **Parking Brake On Audible Warning**

Sounds when you have left the parking brake on and drive your vehicle. If the audible warning remains on after you have released the parking brake, have your vehicle checked by an authorized dealer immediately.

# Information Displays

## GENERAL INFORMATION



**WARNING:** Driving while distracted can result in loss of vehicle control, crash and injury. We strongly recommend that you use extreme caution when using any device that may take your focus off the road. Your primary responsibility is the safe operation of your vehicle. We recommend against the use of any hand-held device while driving and encourage the use of voice-operated systems when possible. Make sure you are aware of all applicable local laws that may affect the use of electronic devices while driving.

**Note:** For your safety, some features are speed-dependent. Their use is limited to when your vehicle speed is not moving.

## Information Display Controls



E275331

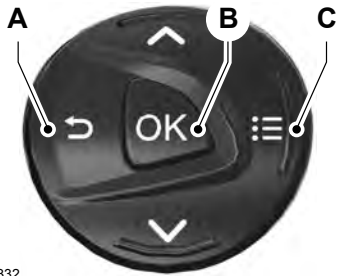

E275332

- A Return button.
- B OK button.
- C Menu button.

### Return Button

Use the return button to go back or to exit.

### OK Button

Use the **OK** button to make a selection. You can also use it to scroll through a menu.

### Menu Button

Use the menu button on the main screen to display the submenu.

## Information Display Menus

### Main Menu

Menu Item
<b>Trip 1 or Trip 2</b>
MyView
Driver Assist.
Navigation



# Information Displays

Menu Item
Audio
Phone
Settings

## Submenus

### *Trip 1 and Trip 2*

Menu Item
Trip 1
Trip 2
Reset Individual Values
Configure View

### *MyView*

Menu Item
Digital Speedometer
Fuel Economy
Trip/Audio
Eco Coach
Calm Screen

### *Driver Assist.*

Menu Item
Traction Control
Blind Spot
Pre-Collision Assist
Traffic Sign Recognition
Lane Keeping System
Driver Alert

Menu Item
Wrong Way Alert
Hill Start Assist
Cross Traffic Alert
Eco Coach
Trailer Sway
Cruise Control
Speed Limiter
Rear Parking Aid

### *Navigation*

Menu Item
Home
Favorite Destinations
Previous Destinations

### *Audio*

Menu Item
Radio
CD
USB device.
Bluetooth device.

### *Phone*

Menu Item
All Calls
Incoming Calls
Missed Calls
Outgoing Calls

# Information Displays

## Settings

Menu Item
Information
Display
Driver Assistance
Vehicle Settings
Vehicle Maintenance
MyKey

## CLOCK

### Type 1

To adjust the clock, switch the ignition on and press buttons H or M on the information and entertainment display as necessary.

### Type 2

**Note:** Use the information display to adjust the clock. See **General Information** (page 92).

## TRIP COMPUTER

### Resetting the Trip Computer

Press and hold **OK** on the current screen to reset the respective trip, distance, time and average fuel information.

### Trip Odometer

Registers the distance traveled of individual journeys.

## INFORMATION MESSAGES

## Distance to Empty

Indicates the approximate distance your vehicle will travel on the fuel remaining in the tank. Changes in driving pattern may cause the value to vary.

## Average Fuel

Indicates the average fuel consumption since the function was last reset.

## Digital Speedometer

The speed your vehicle is traveling at will display as a digital number.

## PERSONALIZED SETTINGS

### Measure Units

To swap between imperial and metric units, scroll to this display and press the **OK** button.

Swapping between imperial and metric units will affect the following displays:

- Distance to empty.
- Average fuel consumption.
- Instantaneous fuel consumption.
- Average speed.

### Switching Chimes Off

The following chimes can be switched off:

- Warning messages.
- Information messages.

# Information Displays

## Active Park Assist

Message	Description
Active Park Fault	The system has malfunctioned. Have your vehicle checked as soon as possible.

## Adaptive Cruise Control

Message	Description
Adaptive Cruise Malfunction	The system has malfunctioned. Have your vehicle checked as soon as possible.
Adaptive Cruise Not Available	The system is not available. See <b>Using Adaptive Cruise Control</b> (page 196).
Adaptive Cruise Not Available Sensor Blocked See Manual	The radar has reduced visibility. See <b>Using Adaptive Cruise Control</b> (page 196).
Normal Cruise Active Adaptive Braking Off	You have switched normal cruise control on. Adaptive braking turns off.
Front Sensor Not Aligned	The system has malfunctioned. Have your vehicle checked as soon as possible.
Adaptive Cruise Control Driver Resume Control	The adaptive cruise has reinstated controls to the driver.
Adaptive Cruise Control Speed Too Low To Activate	Your vehicle speed is too slow to activate the adaptive cruise.
Adaptive Cruise Control Speed Sign Recognition Not Available	Navigation system based speed limit information is not available. If the message continues to appear, have your vehicle checked as soon as possible.

## Alarm

Message	Description
Vehicle Alarm To Stop Alarm, Start Vehicle.	Displays when the alarm has been triggered due to unauthorized entry.

# Information Displays

## Automatic High Beam Control

Message	Description
Front Camera Low Visibility Clean Screen	The camera has reduced visibility. Clean the windshield. If the message continues to appear, have your vehicle checked as soon as possible.
Front Camera Temporarily Not Available	The camera has malfunctioned. Wait a short period of time for the camera to cool down. If the message continues to appear, have your vehicle checked as soon as possible.
Front Camera Malfunction Service Required	The camera has malfunctioned. Have your vehicle checked as soon as possible.

## Auto-Start-Stop

Message	Description
Auto StartStop Press Brake to Start Engine	The system needs to restart the engine but requires your confirmation. Press the brake pedal to restart the engine.
Auto StartStop Press a Pedal to Start Engine	The system needs to restart the engine but requires your confirmation. Press any pedal to restart the engine.
Auto StartStop Select Neutral To Start Engine	The system needs to restart the engine but requires your confirmation. Shift into neutral (N) to restart the engine.
Auto StartStop Shift to P, then Restart Engine	The system needs to restart the engine but requires your confirmation. Shift into park (P) to restart the engine.
Auto StartStop Manual Restart Required	The system is not functioning. Restart the engine.
Auto StartStop Malfunction Service Required	The system has malfunctioned. Have your vehicle checked as soon as possible.

# Information Displays

## Blind Spot Information and Cross Traffic Alert Systems

Message	Description
Blind Spot System Fault	The system has malfunctioned. Have your vehicle checked as soon as possible.
Blind Spot Not Available Sensor Blocked See Manual	The system sensors are blocked. See <b>Blind Spot Information System</b> (page 209).
Blis Deactivated Trailer Attached	You have attached a trailer to your vehicle. The system turns off.
Vehicle Coming From Left  Vehicle Coming From Right	The system detects a vehicle. See <b>Blind Spot Information System</b> (page 209).
Cross Traffic Alert	Displays instead of indication arrows when the system detects a vehicle. Check for approaching traffic.
Cross Traffic System Fault	The system has malfunctioned. Have your vehicle checked as soon as possible.
Cross Traffic Not Avail- able Sensor Blocked See Manual	The system sensors are blocked. See <b>Cross Traffic Alert</b> (page 211).
Cross Traffic Alert Deac- tivated Trailer Attached	You have attached a trailer to your vehicle. The system turns off.
Cross Traffic Alert Applying Brakes	The system applies the brakes. Check for approaching traffic.

## Brake System

Message	Description
Check Brake System	The system has malfunctioned. Stop your vehicle in a safe place. Have your vehicle checked as soon as possible.

# Information Displays

## Doors and Locks

<b>Message</b>	<b>Description</b>
Driver Door Ajar Passenger Door Ajar Rear Left Door Ajar Rear Right Door Ajar Liftgate Ajar	The door listed is not completely closed.
Hood Ajar	The hood is not completely closed.
Switches Inhibited Security Mode	The system has disabled the door switches.

## Driver Alert

<b>Message</b>	<b>Description</b>
Driver Alert Warning Rest Now	Take a break due to low alertness levels.
Driver Alert Warning Rest Suggested	We recommend that you take a break due to low alertness levels.

## Engine

<b>Message</b>	<b>Description</b>
Engine Coolant Over Temperature	Displays when the engine temperature is too high. Stop your vehicle as soon as it is safe to do so, switch the engine off and allow it to cool. Have your vehicle checked as soon as possible.

# Information Displays

## Fuel System

Message	Description
Fuel Level Low	An early reminder of a low fuel condition.
Fuel Level Low Distance Metric:##0 Km To Empty	
Fuel Level Low Distance Imperial:##0 Miles To Empty	
Check Fuel Fill Inlet	The fuel fill inlet may not be properly closed.
Fuel Pressure Low	The system has malfunctioned. Have your vehicle checked as soon as possible.
Water in Fuel Drain Filter	The system detects there is excess water in the fuel filter. Have your vehicle checked as soon as possible.

## Headlamps

Message	Description
Check Headlamp System See manual	Displays if an electrical malfunction occurs with the headlamp system. Have your vehicle checked as soon as possible.

## Hill Start Assist

Message	Description
Hill Start Assist Not Available	The system is not available. Have your vehicle checked as soon as possible. See <b>Hill Start Assist</b> (page 174).

## Lane Keeping System

Message	Description
Lane Keeping Sys. Malfunction Service Required	The system has malfunctioned. Have your vehicle checked as soon as possible.

# Information Displays

## Maintenance

Message	Description
Engine Oil Level Low Add Oil	The engine oil level is low. Stop your vehicle as soon as it is safe to do so and switch the engine off. Check the engine oil level. See <b>Engine Oil Check</b> (page 266). If the message continues to appear, have your vehicle checked as soon as possible.
Low Engine Oil Pressure	The engine oil pressure is low. Stop your vehicle as soon as it is safe to do so and switch the engine off. Check the engine oil level. See <b>Engine Oil Check</b> (page 266). If the message continues to appear, have your vehicle checked as soon as possible.
Change Engine Oil Soon	The engine oil life remaining is 10% or less. See <b>Engine Oil Check</b> (page 266).
Oil Change Required	The oil life left is at 0%. See <b>Engine Oil Check</b> (page 266).
Brake Fluid Level Low	The brake fluid level is low or the brake system has malfunctioned. See <b>Brake Fluid Check</b> (page 272). Have your vehicle checked as soon as possible.
Power Reduced to Lower Engine Temp	The engine has reduced power to help reduce high engine temperature.
Transport Mode Contact Dealer	Transport mode is on. This may not allow some features to properly operate. Have your vehicle checked as soon as possible.
Factory Mode Contact Dealer	Factory mode is on. This may not allow some features to properly operate. Have your vehicle checked as soon as possible.
Washer Fluid Level Low	The washer fluid is low and needs to be refilled. See <b>Washer Fluid Check</b> (page 273).



## Information Displays

### MyKey

Message	Description
Place Key in Backup Location	Displays when trying to create a MyKey and the key is not placed in the backup position. See <b>Passive Key Backup Position</b> (page 55).
Key is Already a MyKey	Displays when trying to create a MyKey with a key already designated as a MyKey.
Hold OK to Create MyKey	Displays when creating a MyKey.
Creation Completed	Displays to confirm that a MyKey has been created.
This Key restricted at Next Key Cycle. Label Key as MyKey	Displays to confirm that the key is restricted after you switch the ignition off.
MyKey not Created	Displays if the system fails to create a MyKey.
Hold OK to Clear MyKeys	Displays when clearing all MyKeys.
All MyKeys Cleared	Displays to confirm that all MyKeys have been cleared.

### Parking Aid

Message	Description
Park Aid Fault	The system has malfunctioned. Have your vehicle checked as soon as possible.
Check Park Aid	
Check Front Park Aid Check Rear Park Aid	
Park Aid Not Available Sensor Blocked See Manual	The system sensors are blocked. See <b>Parking Aids</b> (page 179).
Front Park Aid Not Available Sensor Blocked See Manual	
Rear Park Aid Not Available Sensor Blocked See Manual	
Rear Park Aid Deactivated Trailer attached	You have attached a bike rack, trailer or other object near the sensors on the front or rear of your vehicle.

# Information Displays

---

## Parking Brake

Message	Description
Park Brake Engaged	You have not released the parking brake and your vehicle reaches 3 mph (5 km/h). If the message continues to appear after you have released the parking brake, have your vehicle checked as soon as possible.

## Pre-Collision Assist

Message	Description
Pre-Collision Assist Not Available	The system has malfunctioned. Have your vehicle checked as soon as possible.
Pre-Collision Assist Not Available Sensor Blocked	The system sensors are blocked. See <b>Pre-Collision Assist</b> (page 215).

## Rear Window Lock

Message	Description
Child Lock Malfunction See Manual	The system has malfunctioned. Have your vehicle checked as soon as possible.

## Remote Control

Message	Description
Key Battery Low Replace Soon	The key battery is low. Change the battery as soon as possible.

# Information Displays

## Selective Catalytic Reductant System

### Diesel Exhaust Fluid Level

Message	Description
DEF Level Range: distance metric:###0 km Refill Soon	Refill the diesel exhaust fluid tank as soon as possible. See <b>Selective Catalytic Reductant System</b> (page 160).
DEF Level Range: distance imperial:###0 mi Refill Soon	
DEF Level Low Range: distance metric:###0 km Refill Now	
DEF Level Low Range: distance imperial:###0 mi Refill Now	
DEF Level Empty Speed Limited to avg speed metric:#0 km/h in distance metric:###0 km	
DEF Level Empty Speed Limited to avg speed imperial:#0 MPH in distance imperial:###0 mi	
DEF Level Empty Speed Limited to avg speed metric:#0 km/h Upon Restart	
DEF Level Empty Speed Limited to avg speed imperial:#0 MPH Upon Restart	
DEF Level Empty Speed Limited to avg speed metric:#0 km/h	
DEF Level Empty Speed Limited to avg speed imperial:#0 MPH	

## Information Displays

Message	Description
DEF Level Empty Engine Idled Soon	The diesel exhaust fluid tank is empty. Refill the diesel exhaust fluid tank. The minimum fluid refill quantity required to restart the engine is 1.3 gal (5 L). See <b>Selective Catalytic Reductant System</b> (page 160).
DEF Level Empty Engine Idled See Manual	

### Diesel Exhaust Fluid System Malfunction

Message	Description
DEF Fault Speed Limited to avg speed metric:#0 km/h in distance metric:###0 km	The system has malfunctioned. Have your vehicle checked as soon as possible.
DEF Fault Speed Limited to avg speed imperial:#0 MPH in distance imperial:###0 mi	
DEF Fault Speed Limited to avg speed metric:#0 km/h Upon Restart	
DEF Fault Speed Limited to avg speed imperial:#0 MPH Upon Restart	
DEF Fault Speed Limited to avg speed metric:#0 km/h	
DEF Fault Speed Limited to avg speed imperial:#0 MPH	
DEF Fault Engine Idled Soon	
DEF Fault Engine Idled See Manual	

# Information Displays

## Stability Control

Message	Description
Service AdvanceTrac	The system has malfunctioned. Have your vehicle checked as soon as possible.

## Starting System

Message	Description
Full Accessory Power Active	Displays if you switch the ignition on and do not start the engine.
To START Press Brake	A reminder to press the brake pedal when starting your vehicle.
Cranking Time Exceeded	Displays if your vehicle fails to start.
No Key Detected	The system does not detect a valid passive key inside your vehicle.
Starting System Fault	The system has malfunctioned. Have your vehicle checked as soon as possible.
Restart Now or Key is Needed	Displays if you switch the engine off and the system does not detect a valid passive key inside your vehicle.

## Steering System

Message	Description
Steering Loss Stop Safely	The system has malfunctioned. Stop your vehicle in a safe place. Have your vehicle checked as soon as possible.
Steering Fault Service Now	The system has malfunctioned. Have your vehicle checked as soon as possible.
Steering Assist Fault Service Required	
Steering Lock Malfunction Service Now	

# Information Displays

## Tire Pressure Monitoring System

Message	Description
Tire Pressure Low	One or more tires on your vehicle have low tire pressure.
Tire Pressure Monitor Fault	The system has malfunctioned. Have your vehicle checked as soon as possible.
Tire Pressure Sensor Fault	The system has malfunctioned or the spare tire is in use. If the message continues to appear, have your vehicle checked as soon as possible.

## Transmission

Message	Description
Transmission Malfunction Service Now Transmission Service Required	The system has malfunctioned. Have your vehicle checked as soon as possible.
Transmission Overtemperature Stop Safely Transmission Overheating Stop Safely Transmission Too Hot Press Brake	The transmission is overheating and needs to cool. Stop your vehicle as soon as it is safe to do so, switch the engine off and allow the transmission to cool. If the message continues to appear, have your vehicle checked as soon as possible.
Transmission Limited Function See Manual	The transmission has limited functionality. Have your vehicle checked as soon as possible.
Transmission Warming Up Please Wait	Displays at low outside temperatures, if it takes a few seconds for the transmission to engage a gear. Fully press the brake pedal until the message disappears from the information display.
Transmission Not in Park	Displays as a reminder to shift into park (P).
Press Brake to Unlock Gearshift Lever	Press the brake pedal to unlock the transmission.
Gearshift Lever Unlocked	Displays when the selector lever unlocks.

# Information Displays

---

## Wireless Accessory Charging

<b>Message</b>	<b>Description</b>
Wireless Charger Active	Wireless charging has started.
Charging Terminated Phone misaligned or object between phone and charger detected. Correct the condition to resume charging.	Wireless charging has stopped. Remove objects from the charging surface and place phone on center of charging surface.

# Climate Control

## MANUAL CLIMATE CONTROL

### Switching the Climate Control On and Off



### Switching the Recirculated Air On and Off



**Note:** The air currently in the passenger compartment recirculates.

### Switching the Air Conditioning On and Off



**Note:** Under certain conditions, the air conditioning compressor could continue to operate after you switch air conditioning off.

### Switching Maximum Defrost On and Off



Turn the temperature control clockwise past the highest setting to maximize defrosting.

**Note:** The temperature control springs back to the highest setting.

**Note:** When you switch maximum defrost on, the heated windshield, heated rear window and air conditioning turn on.

**Note:** When you switch maximum defrost off, the heated windshield and heated rear window remain on.

### Switching Maximum Cooling On and Off



Turn the temperature control counterclockwise past the lowest setting to maximize cooling.

**Note:** The temperature control springs back to the lowest setting.

**Note:** When you switch maximum cooling off, air conditioning remains on.

### Setting the Blower Motor Speed



**Note:** Lights on the control illuminate to indicate the blower motor speed.

**Note:** When you switch the blower motor off, air conditioning turns off and the windows could fog up.



# Climate Control

## Directing Air to the Windshield Air Vents



## Directing Air to the Instrument Panel Air Vents



## Directing Air to the Footwell Air Vents



## Setting the Temperature

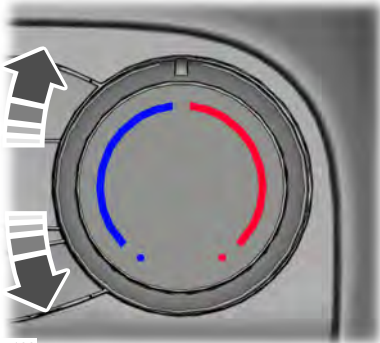

E244106

Turn the temperature control counterclockwise for cooler temperature settings.

Turn the temperature control clockwise for warmer temperature settings.

## AUTOMATIC CLIMATE CONTROL

### Switching the Climate Control On and Off



### Switching the Recirculated Air On and Off



**Note:** The air currently in the passenger compartment recirculates.

**Note:** Recirculated air could turn off or be prevented from turning on in all air flow modes except maximum cooling to reduce the risk of the windows fogging up. It could also turn on and off when you direct air to the instrument panel or footwell air vents during hot weather to improve cooling efficiency.

### Switching the Air Conditioning On and Off



**Note:** Under certain conditions, the air conditioning compressor could continue to operate after you switch air conditioning off.

### Switching Maximum Defrost On and Off



**Note:** When you switch maximum defrost on, the heated windshield, heated rear window and air conditioning turn on. The blower motor is set to the highest speed.

**Note:** When you switch maximum defrost off, the heated windshield and heated rear window remain on.

# Climate Control

## Switching Maximum Cooling On and Off

MAX A/C

**Note:** When you switch maximum cooling off, air conditioning remains on.

## Switching Auto Mode On and Off

AUTO

The system controls the blower motor speed and direction of air to reach and maintain the temperature you have set.

**Note:** When you switch auto mode on, lights on the blower motor control do not illuminate to indicate the blower motor speed.

Adjust the blower motor control or air distribution control to switch auto mode off.

## Adjusting the Auto Mode

AUTO

Repeatedly press to limit the maximum blower motor speed.

**Note:** Limiting the blower motor speed increases the time taken to cool or heat the interior.

## Setting the Blower Motor Speed



**Note:** Lights on the control illuminate to indicate the blower motor speed.

## Switching Dual Mode On and Off

DUAL

**Note:** When you switch dual mode on, the passenger side temperature control can be independently adjusted.

**Note:** You can also switch dual mode on by adjusting the passenger side temperature control.

## Directing Air to the Windshield Air Vents



## Directing Air to the Instrument Panel Air Vents



## Directing Air to the Footwell Air Vents



## Setting the Temperature

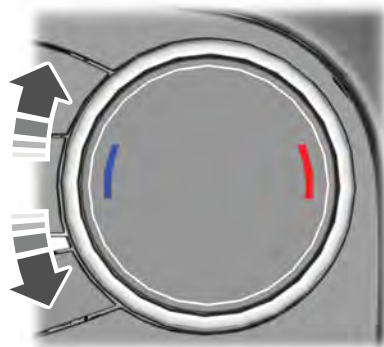

E244115

Turn the temperature control counterclockwise for cooler temperature settings.

Turn the temperature control clockwise for warmer temperature settings.

**Note:** You can adjust the temperature between 60–85°F (15.5–29.5°C).

# Climate Control

---

## HINTS ON CONTROLLING THE INTERIOR CLIMATE - VEHICLES WITH: AUTOMATIC TEMPERATURE CONTROL

### General Hints

Do not place objects under the front seats as this may interfere with directing air to the rear seats.

Remove any snow, ice or leaves from the air intake area at the base of the windshield.

**Note:** *You may feel a small amount of air from the footwell air vents regardless of the air distribution setting.*

**Note:** *To reduce humidity build-up inside your vehicle, do not drive with the system switched off or with recirculated air always switched on.*

**Note:** *Prolonged use of recirculated air may cause the windows to fog up.*

**Note:** *Use air conditioning with recirculated air to improve cooling performance and efficiency.*

**Note:** *When you select automatic mode and the outside temperature is low and the engine is cold, air is directed to the windshield and the outer instrument panel air vents.*

**Note:** *When you select automatic mode and the outside temperature and in-vehicle temperature is high, the system selects recirculated air to maximize cooling. When the required temperature is reached, recirculated air turns off.*

**Note:** *When you select maximum defrost, air conditioning turns on and air is directed to the windshield air vents.*

### Recommended Settings for Heating

- Press AUTO.
- Select the required temperature.

**Note:** *Adjusting the settings when your vehicle interior is extremely hot or cold is not necessary. The system automatically adjusts to heat or cool the interior to your selected temperature as quickly as possible. For the system to function efficiently, the instrument panel and side air vents should be fully open.*

### Quickly Cooling the Interior

- Press MAX A/C.

**Note:** *To improve the time to reach a comfortable temperature in hot weather, drive with the windows open until you feel cold air through the air vents.*

### Recommended Settings for Cooling

- Press AUTO.
- Select the required temperature.

### Defogging the Side Windows in Cold Weather

- Select maximum defrost.

### Defogging or Clearing the Windshield of Thin Ice

- Select maximum defrost.

# Climate Control

## HINTS ON CONTROLLING THE INTERIOR CLIMATE - VEHICLES WITH: MANUAL TEMPERATURE CONTROL

### General Hints

Do not place objects under the front seats as this may interfere with directing air to the rear seats.

Remove any snow, ice or leaves from the air intake area at the base of the windshield.

**Note:** You may feel a small amount of air from the footwell air vents regardless of the air distribution setting.

**Note:** To reduce humidity build-up inside your vehicle, do not drive with the system switched off or with recirculated air always switched on.

**Note:** To reduce fogging of the windshield during humid weather conditions, direct air to the windshield air vents.

**Note:** Prolonged use of recirculated air may cause the windows to fog up.

**Note:** Use air conditioning with recirculated air to improve cooling performance and efficiency.

### Quickly Heating the Interior

- Select the highest blower motor speed.
- Select the highest temperature.
- Direct air to the footwell air vents.

### Recommended Settings for Heating

- Select a medium blower motor speed.
- Select the required temperature.
- Direct air to the footwell and windshield air vents.

### Quickly Cooling the Interior

- Select maximum cooling.

**Note:** To improve the time to reach a comfortable temperature in hot weather, drive with the windows open until you feel cold air through the air vents.

### Recommended Settings for Cooling

- Select a medium blower motor speed.
- Select the required temperature.
- Direct air to the instrument panel air vents.
- Press A/C.

### Defogging the Side Windows in Cold Weather

- Select maximum defrost.

### Defogging or Clearing the Windshield of Thin Ice

- Select maximum defrost.

## REAR PASSENGER CLIMATE CONTROLS

### Switching the Rear Passenger Climate Controls On and Off



Press the button on the front climate controls.

**Note:** You can also switch off the rear passenger climate controls by adjusting the rear blower motor speed to zero.

# Climate Control

## Adjusting the Blower Motor Speed



## Directing Air to the Overhead Air Vents



When you direct air to the overhead air vents, the system distributes cold air.

## Directing Air to the Footwell Air Vents



When you direct air to the footwell air vents, the system distributes hot air.

## Directing Air to the Overhead Air Vents and the Footwell Air Vents



When you direct air to the Overhead and footwell air vents, the system distributes warm air.

## HEATED WINDSHIELD



Press the button to clear the windshield of thin ice and fog. The heated windshield turns off after a short period of time.

**Note:** Make sure that the engine is running before switching the heated windshield on.

**Note:** The system does not operate if the battery charge level is low.

## HEATED REAR WINDOW



Press the button to clear the rear window of thin ice and fog. The heated rear window turns off after a short period of time.

**Note:** Make sure the engine is on before operating the heated windows.

**Note:** Do not use razor blades or other sharp objects to clean or remove decals from the inside of the heated rear window. The vehicle Warranty may not cover damage caused to the heated rear window grid lines.

## HEATED EXTERIOR MIRRORS

When you switch the heated rear window on, the heated exterior mirrors turn on.

**Note:** Do not remove ice from the mirrors with a scraper or adjust the mirror glass when it is frozen in place.

**Note:** Do not clean the mirror housing or glass with harsh abrasives, fuel or other petroleum-based cleaning products.

## CABIN AIR FILTER

Your vehicle is equipped with a cabin air filter. It is located behind the center console.

If your vehicle has rear climate control. The cabin air filter is under the driver seat.

The particulate filtration system reduces the concentration of airborne particles such as dust, spores and pollen in the air supplied to the interior of your vehicle.

**Note:** Make sure you have a cabin air filter installed at all times. This prevents foreign objects from entering the system. Running the system without a filter in place could result in degradation or damage to the system.

# Climate Control

---

The particulate filtration system gives you and your passengers the following benefits:

- It improves your driving comfort by reducing particle concentration.
- It improves the interior compartment cleanliness.
- It protects the climate control components from particle deposits.

Replace the filter element at regular intervals. See **Replacement Parts Recommendation** (page 13).

For additional cabin air filter information, or to replace the filter element, see an authorized dealer.

# Seats

## SITTING IN THE CORRECT POSITION



**WARNING:** Do not recline the seatback too far as this can cause the occupant to slide under the seatbelt, resulting in serious injury in the event of a collision.



**WARNING:** Always sit upright against your seatback with your feet on the floor.



**WARNING:** Do not place objects higher than the top of the seat backrest. Failure to follow this instruction could result in personal injury or death in the event of a sudden stop or crash.

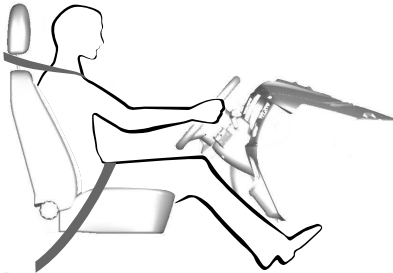

E688595

When you use them properly, the seat, head restraint, seatbelt and airbags will provide optimum protection in the event of a crash.

We recommend that you follow these guidelines:

- Sit in an upright position with the base of your spine as far back as possible.
- Do not recline the seat backrest more than 30°.
- Adjust the head restraint so that the top of it is level with the top of your head and as far forward as possible. Make sure that you remain comfortable.
- Keep sufficient distance between yourself and the steering wheel. We recommend a minimum of 10 in (25 cm) between your breastbone and the airbag cover.
- Hold the steering wheel with your arms slightly bent.
- Bend your legs slightly so that you can press the pedals fully.
- Position the shoulder strap of the seatbelt over the center of your shoulder and position the lap strap tightly across your hips.

Make sure that your driving position is comfortable and that you can maintain full control of your vehicle.

## HEAD RESTRAINTS



**WARNING:** Adjust the head restraints for all passengers before you drive your vehicle. This will help minimize the risk of neck injury in the event of a crash. Do not adjust the head restraints when your vehicle is moving.

# Seats



**WARNING:** The head restraint is a safety device. Whenever possible it should be installed and properly adjusted when the seat is occupied. An improperly adjusted head restraint may not adequately protect an occupant during an impact from the rear.



**WARNING:** Install the head restraint properly to help minimize the risk of neck injury in the event of a crash.

**Note:** Adjust the seat backrest to an upright driving position before adjusting the head restraint. Adjust the head restraint so that the top of it is level with the top of your head and as far forward as possible. Make sure that you remain comfortable. If you are extremely tall, adjust the head restraint to its highest position.

## Front Seat Head Restraint

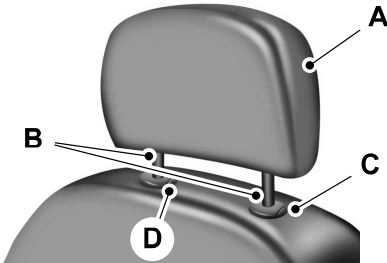

E138642

## Second Row Outboard Head Restraints

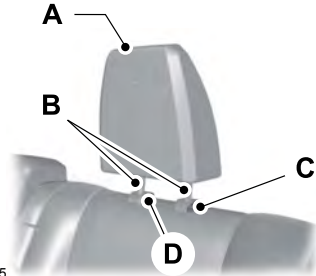

E153105

## Second Row Center Head Restraint and Third Row Head Restraints

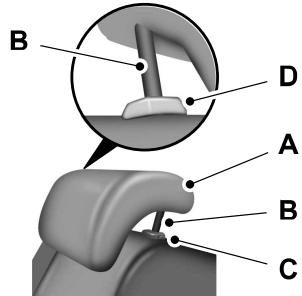

E138645

The head restraints consist of:

- A Energy absorbing head restraint.
- B Steel stems.
- C Guide sleeve adjust and unlock button.
- D Guide sleeve unlock and remove button.

## Adjusting the Head Restraint

### Raising the Head Restraint

Pull the head restraint up.



# Seats

## Lowering the Head Restraint

1. Press and hold button C.
2. Push the head restraint down.

## Removing the Head Restraint

1. Pull the head restraint up until it reaches its highest position.
2. Press and hold buttons C and D.
3. Pull the head restraint up.

## Installing the Head Restraint

Align the steel stems into the guide sleeves and push the head restraint down until it locks.

## Tilting Head Restraints (If Equipped)

The head restraints tilt for extra comfort. To tilt the head restraint, do the following:



E144727

1. Adjust the seat backrest to an upright driving or riding position.
2. Pivot the head restraint forward toward your head to the desired position.

After the head restraint reaches the forward-most tilt position, pivot it forward again to release it to the rearward, un-tilted position.

## MANUAL SEATS



**WARNING:** Do not adjust the driver seat when your vehicle is moving.



**WARNING:** Do not place cargo or any objects behind the seat backrest before returning it to the original position. Pull on the seat backrest to make sure that it has fully latched after returning the seat backrest to its original position. An unlatched seat may become dangerous if you stop suddenly or have a crash.

## Moving the Seat Backward and Forward



**WARNING:** Make sure the seat fully locks into place by rocking it backward and forward. Not securing the seat into the locked position can be dangerous in a crash and could cause serious personal injury or death.



E130249

# Seats

## Adjusting the Seat Backrest

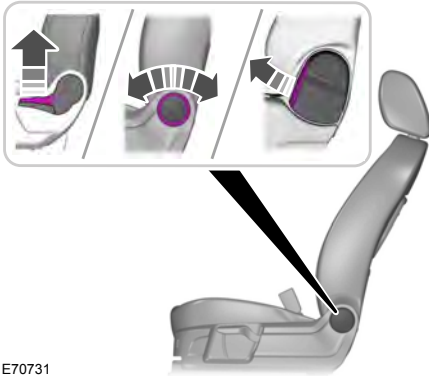

E70731

## Adjusting the Lumbar Support (If Equipped)



E142199

## Adjusting the Seat Height (If Equipped)

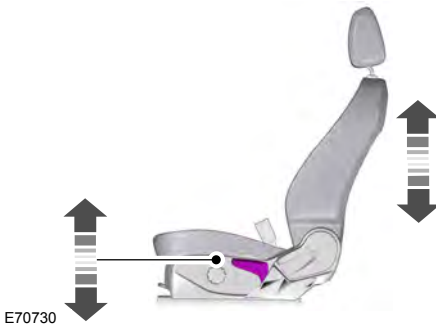

E70730

## Single Passenger Seat (If Equipped)

**WARNING:** When folding the seat backrest down, take care not to get your fingers caught in the mechanism.

**WARNING:** Do not sit in a seat facing a folded seat. Failure to follow this instruction could result in personal injury in the event of a sudden stop or crash.

## Folding the Seat Backrest



E275437

# Seats

1. Move the seat fully backward.

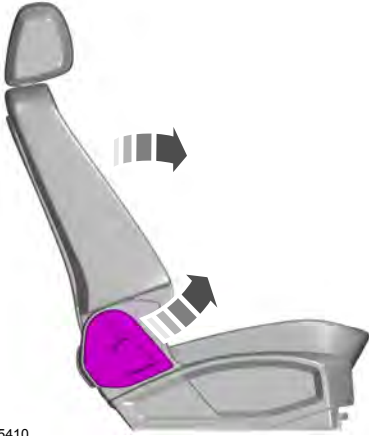

E275410

2. Fold the seat backrest fully forward.



E275411



3. Fully lower the head restraint.



E275412

4. Pull the lever.
5. Push the seat backrest forward.

## POWER SEATS

-  **WARNING:** Do not adjust the driver's seat or seatback when your vehicle is moving.
-  **WARNING:** Do not place cargo or any objects behind the seatback before returning it to the original position.

# Seats

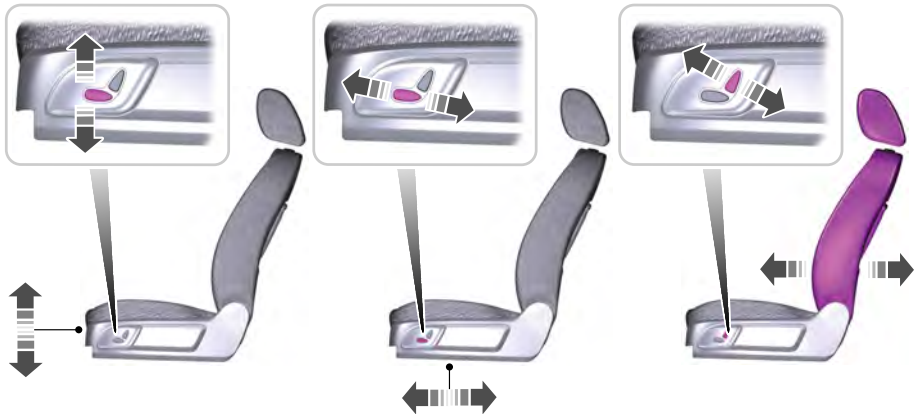

E167101

## REAR SEATS - SHORT WHEELBASE

**WARNING:** Do not use the bench seats as a bed when your vehicle is moving. Failure to follow this warning could result in serious personal injury or death.

**WARNING:** When folding or unfolding the seats, take care not to get your fingers caught between the seat backrest and seat frame. Failure to follow this warning could result in serious personal injury.

**WARNING:** Do not sit in a seat facing a folded seat. Failure to follow this instruction could result in personal injury in the event of a sudden stop or crash.

**WARNING:** Do not place any objects on a folded seat. Hard objects may become projectiles in a crash or sudden stop, which may increase the risk of serious personal injury.

## Second Row Seats

### Folding the Seat

1. Fully lower the head restraints. See **Head Restraints** (page 115).

# Seats

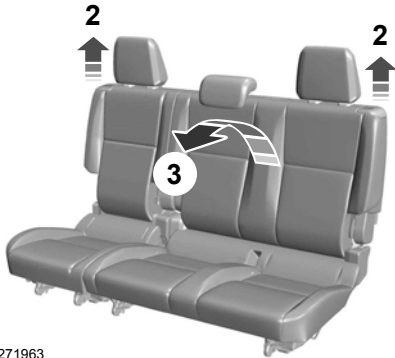

E271963

2. Pull the lever on the top of the seat.
3. Fold the seat backrest forward.

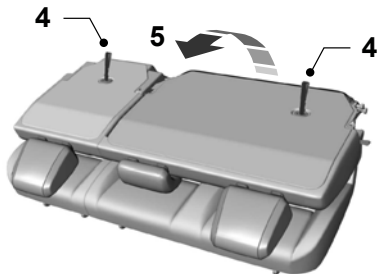

E271964

4. Pull the strap on the rear of the seat backrest.
5. Raise the seat.

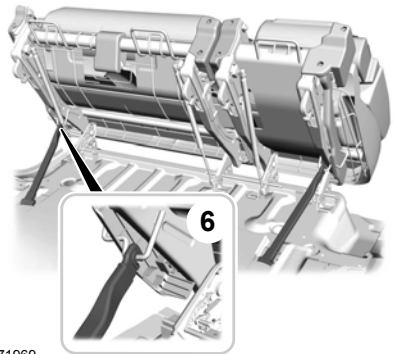

E271969

6. Lift the support rod and connect it to the seat frame. This prevents the seat from falling backward.

**Note:** Rear row occupants can sit next to a seat in the same row that has the seat backrest in the folded position, but not when the seat is in the tilted position.

## Unfolding the Seat

1. Disconnect the support rod from the seat frame.
2. Unfold the seat backward and lock into position.
3. Unfold the seat backrest backward and lock into position.

# Seats

## Removing the Seat

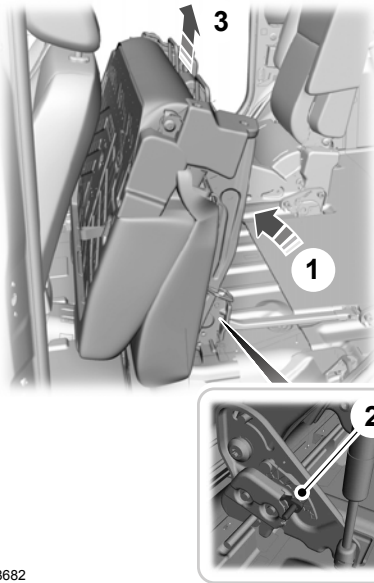

E168682

1. Raise the seat.
2. Rotate the locking lever.
3. Remove the seat.

## Installing the Seat

1. Align the seat catches, push the seat down and lock into position.
2. Unfold the seat backward and lock into position.
3. Unfold the seat backrest backward and lock into position.

## Third Row Seats

### Moving the Seat Backward and Forward

 **WARNING:** Make sure the seat fully locks into place by rocking it backward and forward. Not securing the seat into the locked position can be dangerous in a crash and could cause serious personal injury or death.



E271965

### Folding the Seat Backrest

1. Fully lower the head restraints. See **Head Restraints** (page 115).
2. Fully move the seat backward.

# Seats

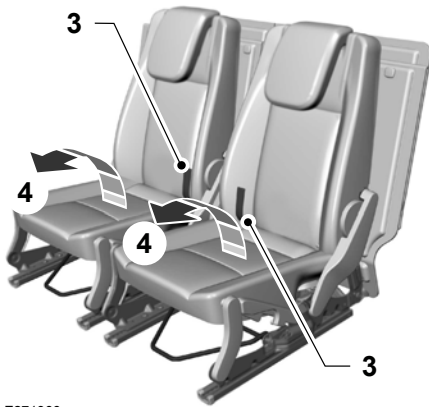

E271966

3. Pull the strap on the rear of the seat backrest.
4. Fold the seat cushion forward.

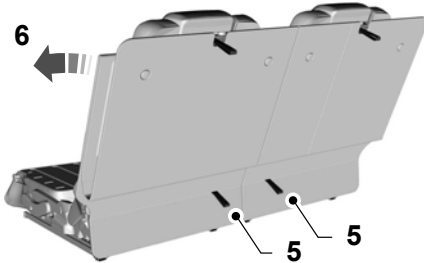

E272026

5. Pull the strap on the rear of the seat backrest.
6. Fold the seat backrest forward.

**Note:** Rear row occupants can sit next to a seat in the same row that has the seat backrest in the folded position, but not when the seat is in the tilted position.

## Unfolding the Seat Backrest

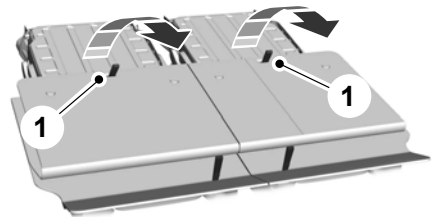

E167644

1. Pull the strap on the rear of the seat backrest.
2. Unfold the seat backrest backward and lock into position.
3. Unfold the seat cushion backward and lock into position.

## Creating a Level Load Floor



E167645

The carpeted cover is held in position by magnets. Fold the carpeted cover forward to cover up the folded seats.

# Seats

## REAR SEATS - LONG WHEELBASE, VEHICLES WITH: SECOND ROW DUAL CAPTAIN CHAIRS



**WARNING:** When folding or unfolding the seats, take care not to get your fingers caught between the seat backrest and seat frame. Failure to follow this warning could result in serious personal injury.



**WARNING:** Do not use the bench seats as a bed when your vehicle is moving. Failure to follow this warning could result in serious personal injury or death.



**WARNING:** Do not place any objects on a folded seat. Hard objects may become projectiles in a crash or sudden stop, which may increase the risk of serious personal injury.



**WARNING:** Do not sit in a seat facing a folded seat. Failure to follow this instruction could result in personal injury in the event of a sudden stop or crash.

### Second Row Seats

#### Folding the Seat

1. Fully lower the head restraint. See **Head Restraints** (page 115).

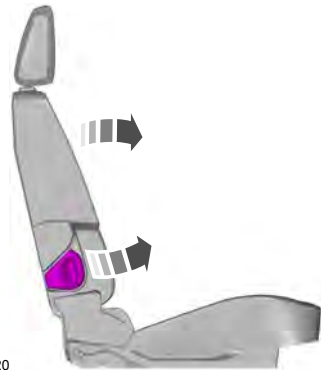

E276420

2. Pull the lever.
3. Fold the seat backrest forward.



E276421

4. Pull the strap.
5. Move the seat forward to the lowered position.



# Seats

## Unfolding the Seat



E276422

1. Pull the strap.
2. Lift the seat and move it backward.



E276423

3. Pull the strap.
4. Unfold the seat backrest backward.

## Third Row Seats

### Moving the Seat Backward and Forward

 **WARNING:** Make sure the seat fully locks into place by rocking it backward and forward. Not securing the seat into the locked position can be dangerous in a crash and could cause serious personal injury or death.



E271965

### Folding the Seat Backrest

1. Fully lower the head restraints. See **Head Restraints** (page 115).
2. Fully move the seat backward.

# Seats

## Unfolding the Seat Backrest

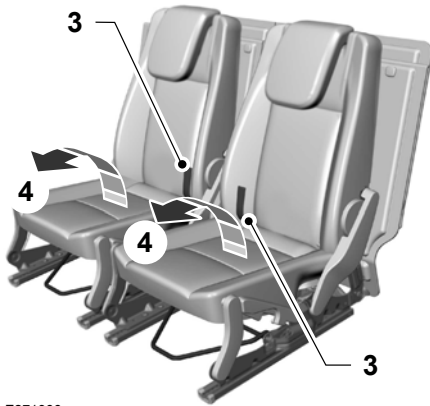

E271966

3. Pull the strap on the rear of the seat backrest.
4. Fold the seat cushion forward.

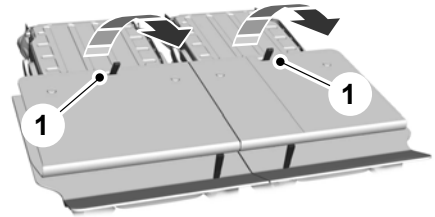

E167644

1. Pull the strap on the rear of the seat backrest.
2. Unfold the seat backrest backward and lock into position.
3. Unfold the seat cushion backward and lock into position.

## Creating a Level Load Floor

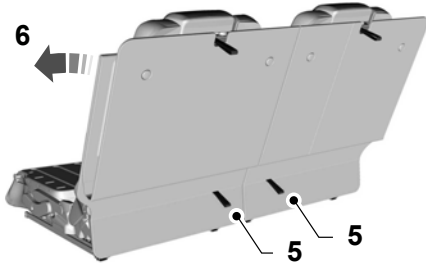

E272026

5. Pull the strap on the rear of the seat backrest.
6. Fold the seat backrest forward.



E167645

The carpeted cover is held in position by magnets. Fold the carpeted cover forward to cover up the folded seats.

**Note:** Rear row occupants can sit next to a seat in the same row that has the seat backrest in the folded position, but not when the seat is in the tilted position.

# Seats

## REAR SEATS - LONG WHEELBASE, VEHICLES WITH: 60/40 SPLIT SECOND ROW SEATING



**WARNING:** When folding or unfolding the seats, take care not to get your fingers caught between the seat backrest and seat frame. Failure to follow this warning could result in serious personal injury.



**WARNING:** Do not use the bench seats as a bed when your vehicle is moving. Failure to follow this warning could result in serious personal injury or death.



**WARNING:** Do not place any objects on a folded seat. Hard objects may become projectiles in a crash or sudden stop, which may increase the risk of serious personal injury.



**WARNING:** Do not sit in a seat facing a folded seat. Failure to follow this instruction could result in personal injury in the event of a sudden stop or crash.

### Second Row Seats

#### Folding the Seat

1. Fully lower the head restraints. See **Head Restraints** (page 115).



E271960

2. Pull the lever on the top of the seat.
3. Fold the seat backrest forward, then push down on the center of the seat backrest to lock the latches.

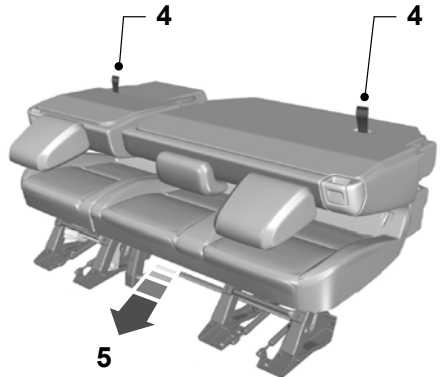

E271961

4. Pull the strap on the rear of the seat backrest.

# Seats

5. Move the seat forward to the lowered position, then push down on the center of the seat backrest to lock the latches.

**Note:** A distinct click sounds when the seat is locked in the lowered position.

**Note:** Rear row occupants can sit next to a seat in the same row that has the seat backrest in the folded position, but not when the seat is in the tilted position.

## Unfolding the Seat

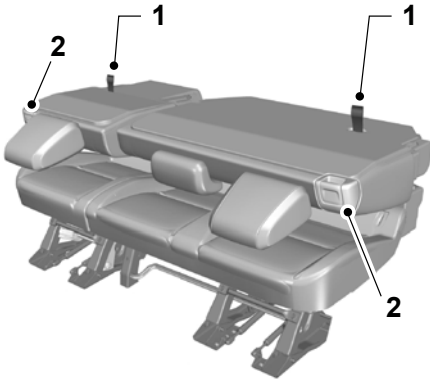

E271962

1. Pull the strap on the rear of the seat backrest, lift the seat and push down to lock into position.
2. Pull the lever on the top of the seat, unfold the seat backrest backward and lock into position. Push down in the center of the seat to make sure the latches are locked.

**Note:** You cannot unfold the seat backrest if a red flag is visible on the large strap. Make sure the seat is locked and the red flag is not visible.

## Third Row Seats

### Moving the Seat Backward and Forward

 **WARNING:** Make sure the seat fully locks into place by rocking it backward and forward. Not securing the seat into the locked position can be dangerous in a crash and could cause serious personal injury or death.



E271965

### Folding the Seat Backrest

1. Fully lower the head restraints. See **Head Restraints** (page 115).
2. Fully move the seat backward.

# Seats

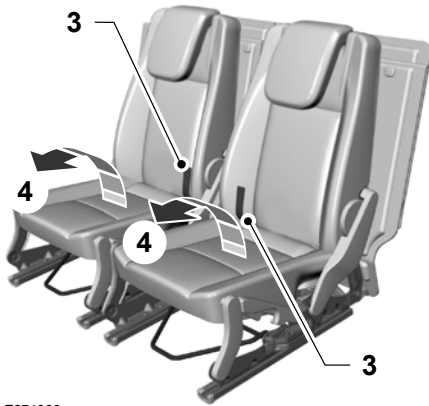

E271966

3. Pull the strap on the rear of the seat backrest.
4. Fold the seat cushion forward.

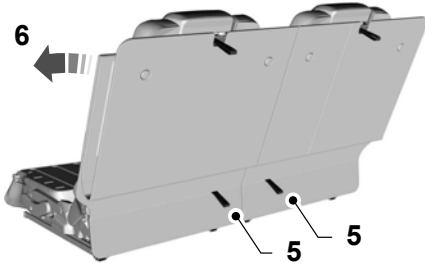

E272026

5. Pull the strap on the rear of the seat backrest.
6. Fold the seat backrest forward.

**Note:** Rear row occupants can sit next to a seat in the same row that has the seat backrest in the folded position, but not when the seat is in the tilted position.

## Unfolding the Seat Backrest

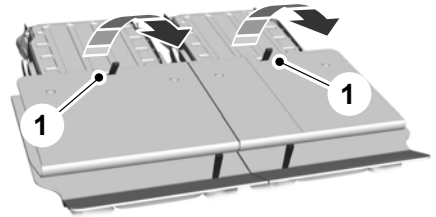

E167644

1. Pull the strap on the rear of the seat backrest.
2. Unfold the seat backrest backward and lock into position.
3. Unfold the seat cushion backward and lock into position.

## Creating a Level Load Floor



E167645

The carpeted cover is held in position by magnets. Fold the carpeted cover forward to cover up the folded seats.

# Seats

## HEATED SEATS (If Equipped)



**WARNING:** People who are unable to feel pain to their skin because of advanced age, chronic illness, diabetes, spinal cord injury, medication, alcohol use, exhaustion or other physical conditions, must use caution when using the heated seat. The heated seat may cause burns even at low temperatures, especially if used for long periods of time. Do not place anything on the seat that may block the heat, such as a blanket or cushion. This can cause the heated seat to overheat. Do not puncture the seat with pins, needles or other pointed objects. This damages the heating element and can cause the heated seat to overheat. An overheated seat may cause serious personal injury.

Do not do the following:

- Place heavy objects on the seat.
- Operate the heated seat if water or any other liquid spills on the seat. Allow the seat to dry thoroughly.
- Operate the heated seats unless the engine is running. Doing so can cause the battery to lose charge.



E146322

Press the heated seat symbol to cycle through the various heat settings and off. More indicator lights indicate warmer settings.

# Auxiliary Power Points

## 12 Volt DC Power Point



**WARNING:** Do not plug optional electrical accessories into the cigar lighter socket. Incorrect use of the cigar lighter can cause damage not covered by the vehicle warranty, and can result in fire or serious injury.



**WARNING:** Do not use a power point for operating a cigar lighter. Incorrect use of the power points can cause damage not covered by the vehicle warranty, and can result in fire or serious injury.

Do not hang any accessory from the accessory plug.

Do not use the power point over the vehicle capacity of 12 volt DC 180 watts or a fuse may blow.

Keep the power point caps closed when not in use.

Do not insert objects other than an accessory plug into the power point.

You can use the power point for up to 20 minutes after you switch the ignition off.

**Note:** When you switch the ignition on, you can use the socket to power 12 volt appliances with a maximum current rating of 15 amps.

Run the vehicle for full capacity use of the power point.

To prevent the battery from running out of charge:

- Do not use the power point longer than necessary when the vehicle is not running.
- Do not leave devices plugged in overnight or when you park your vehicle for extended periods.

Power points may be in the following locations:

- Front of the floor console.
- Rear of the floor console.
- Right hand side of the luggage compartment.
- Instrument panel cluster storage compartment.

## CIGAR LIGHTER



**WARNING:** Do not plug optional electrical accessories into the cigar lighter socket. Incorrect use of the cigar lighter can cause damage not covered by the vehicle warranty, and can result in fire or serious injury.

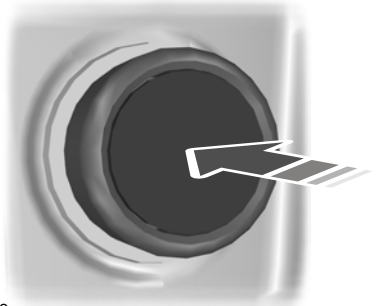

E103382

Press the element in to use the cigar lighter. It pops out after a short period of time.

Do not hold the cigar lighter element pressed in.

**Note:** If the power supply does not work after you switch the ignition off, switch the ignition on.

# Auxiliary Power Points

**Note:** If you use the socket when the engine is not running, the battery may run out of charge.

**Note:** When you switch the ignition on, you can use the socket to power 12 volt appliances with a maximum current rating of 15 amps.

## WIRELESS ACCESSORY CHARGING



**WARNING:** Wireless charging devices can affect the operation of implanted medical devices, including cardiac pacemakers. If you have any implanted medical devices, we recommend that you consult with your physician.

The system supports one wireless charging compatible device on the charging area.

**Note:** Devices without built-in Qi standards for wireless charging require an additional Qi receiver or sleeve.

Make sure the charging area is clean before charging a device.

Do not place items with a magnetic strip, for example passports, parking tickets or credit cards near the charging area when charging a device. This could damage the magnetic strip.

Do not place metal objects, for example remote controls, coins or keys on or near the charging area when charging a device. Metal objects may heat up and degrade the charging performance.



The charging area is below the audio unit.



E270527

Place the device with the charging side down to begin charging. The charging stops after your device reaches a full charge.

**Note:** Charging time and temperature are dependent on the device used. The system stops charging the device if it reaches a high temperature.



# Storage Compartments

## CUP HOLDERS



**WARNING:** Do not place hot drinks in the cup holders when your vehicle is moving.



**WARNING:** Make sure that cups placed in the holders do not obstruct your vision while driving.

## OVERHEAD CONSOLE



**WARNING:** Do not place heavy objects in the storage compartment. Heavy objects may become projectiles in a crash or sudden stop, which may increase the risk of serious injury.



E175398

## Rear Door Storage Compartment (If Equipped)



E188482

# Starting and Stopping the Engine

## GENERAL INFORMATION



**WARNING:** Extended idling at high engine speeds can produce very high temperatures in the engine and exhaust system, creating the risk of fire or other damage.



**WARNING:** Do not park, idle or drive your vehicle on dry grass or other dry ground cover. The emission system heats up the engine compartment and exhaust system, creating the risk of fire.



**WARNING:** Do not start the engine in a closed garage or in other enclosed areas. Exhaust fumes can be toxic. Always open the garage door before you start the engine.



**WARNING:** Exhaust leaks may result in entry of harmful and potentially lethal fumes into the passenger compartment. If you smell exhaust fumes inside your vehicle, have your vehicle inspected immediately. Do not drive if you smell exhaust fumes.

If you disconnect the battery, your vehicle may exhibit some unusual driving characteristics for approximately 5 mi (8 km) after you reconnect it. This is because the engine management system must realign itself with the engine. You can disregard any unusual driving characteristics during this period.

The powertrain control system meets all Canadian interference-causing equipment standard requirements regulating the impulse electrical field or radio noise.

When you start the engine, avoid pressing the accelerator pedal before and during operation. Only use the accelerator pedal when you have difficulty starting the engine.

## IGNITION SWITCH



E72128

**O** (off) - The ignition is off.

**Note:** When you switch the ignition off and leave your vehicle, do not leave your key in the ignition. This could cause your vehicle battery to lose charge.

**Note:** To switch the engine off when your vehicle is moving, move the transmission selector lever to position **N**. Use the brakes to bring the vehicle to a safe stop. After your vehicle has stopped, switch the engine off and move the transmission selector lever to position **P**. Turn the key to position **O** or **I**.

**I** (accessory) - Allows the electrical accessories such as the radio to operate while the engine is not running.

**Note:** Do not leave the ignition key in this position for too long. This could cause your vehicle battery to lose charge.

**II** (on) - All electrical circuits operational. Warning lamps and indicators are illuminated.

**III** (start) - cranks the engine. Release the key as soon as the engine starts.

# Starting and Stopping the Engine

## PUSH BUTTON IGNITION SWITCH



**WARNING:** Always check that the steering wheel lock is deactivated before attempting to move your vehicle. Failure to deactivate the steering wheel lock could result in a crash.

## Switching the Ignition On to Accessory Mode



Press the push button ignition switch once without your foot on the brake or clutch pedal. It is on the instrument panel near the steering wheel. All electrical circuits and accessories are operational and the warning lamps and indicators illuminate.

Press the push button ignition switch again without your foot on the brake or clutch pedal to switch the ignition off.

**Note:** The system may not function if the passive key is close to metal objects or electronic devices, for example keys or a cell phone.

**Note:** The ignition turns off if you leave your vehicle unattended. This is to prevent the vehicle battery from losing charge.

**Note:** A valid passive key must be inside your vehicle to switch the ignition on and start the engine.

## Starting The Engine - Vehicles with Manual Transmission (If Equipped)

1. Fully press the clutch pedal.
2. Press the push button ignition switch.

**Note:** If you release the clutch pedal during engine starting, the engine stops cranking.

## Starting The Engine - Vehicles with Automatic Transmission (If Equipped)

1. Fully press the brake pedal.
2. Shift into park (P).
3. Press the push button ignition switch.

**Note:** If you release the brake pedal during engine starting, the engine stops cranking.

## Vehicles with a Diesel Engine (If Equipped)

**Note:** The engine does not crank until the glow plug indicator turns off. This may take several seconds in extremely cold conditions.

## Failure to Start - Vehicles with Manual Transmission (If Equipped)

The system does not function if:

- The passive key frequencies are jammed.
- The key battery has no charge.

If you are unable to start the engine, do the following:

1. Insert the passive key into the backup position. See **Passive Key Backup Position** (page 55).
2. With the passive key in this position, you can use the push button ignition switch to switch the ignition on and start the engine.

# Starting and Stopping the Engine

If the engine does not crank after you fully press the clutch pedal and press the push button ignition switch, do the following:

1. Fully press the clutch pedal and the brake pedal.
2. Press the push button ignition switch.

## Stopping the Engine When Your Vehicle is Stationary - Vehicles with Manual Transmission (If Equipped)

Press the push button ignition switch.

**Note:** The ignition, all electrical circuits and all warning lamps and indicators turn off.

## Stopping the Engine When Your Vehicle is Stationary - Vehicles with Automatic Transmission (If Equipped)

1. Fully press the brake pedal.
2. Shift into park (P).
3. Press the push button ignition switch.

**Note:** The ignition, all electrical circuits and all warning lamps and indicators turn off.

## Stopping the Engine When Your Vehicle is Moving - Vehicles with Manual Transmission (If Equipped)

 **WARNING:** Switching off the engine when your vehicle is still moving results in a significant decrease in braking assistance. Higher effort is required to apply the brakes and to stop your vehicle. A significant decrease in steering assistance could also occur. The steering does not lock, but higher effort could be required to steer your vehicle. When you switch the ignition off, some electrical circuits, for example airbags, also turn off. If you unintentionally switch the ignition off, shift into neutral (N) and restart the engine.

1. Press and hold the push button ignition switch until the engine stops, or press it three times within two seconds.
2. Shift into neutral and use the brakes to bring your vehicle to a safe stop.
3. Press the push button ignition switch.

## Stopping the Engine When Your Vehicle is Moving - Vehicles with Automatic Transmission (If Equipped)

 **WARNING:** Switching off the engine when your vehicle is still moving results in a significant decrease in braking assistance. Higher effort is required to apply the brakes and to stop your vehicle. A significant decrease in steering assistance could also occur. The steering does not lock, but higher effort could be required to steer your vehicle. When you switch the ignition off, some electrical circuits, for example airbags, also turn off. If you unintentionally switch the ignition off, shift into neutral (N) and restart the engine.

1. Press and hold the push button ignition switch until the engine stops, or press it three times within two seconds.
2. Shift into neutral and use the brakes to bring your vehicle to a safe stop.
3. Shift into park (P).
4. Press the push button ignition switch.

## Fast Restart

The system allows you to start the engine within 10 seconds of switching it off, even if it does not detect a valid passive key.

Within 10 seconds of switching the engine off, fully press the brake or clutch pedal and press the push button ignition switch. After 10 seconds, you can no longer start the engine if the system does not detect a valid passive key.

# Starting and Stopping the Engine

When you start the engine, it remains running until you press the push button ignition switch, even if your vehicle does not detect a valid passive key. If you open

and close a door when the engine is running, the system searches for a valid passive key.

## Starting System Information Messages

Message	Action
Full Accessory Power Active	Displays if you switch the ignition on and do not start the engine.
To START Press Brake	Displays when you start the engine as a reminder to fully press the brake pedal.
To START Press Clutch	Displays when you start the engine as a reminder to fully press the clutch pedal.
To START Press Brake and Clutch	Displays when you start the engine as a reminder to fully press the brake and clutch pedals.
Cranking Time Exceeded	Displays if the engine fails to start.
No Key Detected	Displays if the system does not detect a valid passive key.
Starting System Fault	Displays if you are unable to start the engine with a correctly coded key. The system has detected a fault that requires service. Have your vehicle checked as soon as possible.
Restart Now or Key is Needed	Displays for 10 seconds if you switch the engine off and the system does not detect a valid passive key. After 10 seconds, you can no longer start the engine if the system does not detect a valid passive key.

## Key Outside Vehicle Audible Warning

Sounds when you remove the passive key from your vehicle and the engine is running.

## STARTING A GASOLINE ENGINE

The speed at which the engine idles immediately after starting is optimized to minimize vehicle emissions and maximize cabin comfort and fuel economy.

**Note:** *You can only attempt to start the engine for a limited amount of time before the starting system temporarily disables. If you exceed the starting time limit, a message may appear and you cannot attempt to start the engine for at least 15 minutes.*

Before starting your vehicle, check the following:

- Make sure the headlamps and electrical accessories are off.
- Make sure the parking brake is on.
- Make sure the transmission is in park (P).

# Starting and Stopping the Engine

## Vehicles with an Ignition Key

1. Fully press the brake pedal.

**Note:** Do not touch the accelerator pedal.

2. Turn the key to position **III**.

**Note:** The engine may continue cranking for up to 15 seconds or until it starts.

**Note:** The engine takes longer to start at lower temperatures. It may crank for several seconds when very cold.

## Vehicles with a Push Button Ignition Switch

See **Push Button Ignition Switch** (page 135).

## Failure to Start

### Vehicles with an Ignition Key

If you cannot start the engine after 3 attempts, wait 10 seconds and do the following:

1. Fully press the brake pedal.
2. Apply the parking brake.
3. Shift into park (P).
4. Fully press the accelerator pedal and hold it there.
5. Turn the key to position **III** until the engine starts.

### Switching the Automatic Engine Shutdown On or Off

**To switch the automatic engine shutdown on or off, use the information display controls on the steering wheel to select the following:**

Menu Item	Action
Settings	Press the menu button.
Vehicle Settings	Press the <b>OK</b> button.
Auto Engine Off	Press the <b>OK</b> button.

## Vehicles with a Push Button Ignition Switch

See **Push Button Ignition Switch** (page 135).

## Automatic Engine Shutdown

For vehicles with a push button ignition switch, the engine shuts down if it has been idling for an extended period. The ignition also turns off to save battery power. Before your vehicle shuts down, a message appears in the information display showing a timer counting down. If you do not intervene within 30 seconds, your vehicle shuts down. Another message appears in the information display to inform you that your vehicle has shut down to save fuel. Start your vehicle as normal.

### Automatic Engine Shutdown Override

You can stop the shutdown, or reset the timer, at any point before the 30-second countdown has expired by doing any of the following:

- Pressing the brake or accelerator pedal.
- Switching off the automatic engine shutdown in the information display.
- Pressing the **OK** or **RESET** button during the 30-second countdown.

# Starting and Stopping the Engine

**Note:** You cannot permanently switch off the automatic shutdown. If you switch it off, it turns on each time you switch the ignition on.

## Stopping the Engine When Your Vehicle is Stationary

### Vehicles with an Ignition Key

1. Shift into park (P).
2. Turn the key to position **0**.
3. Apply the parking brake.

### Vehicles with a Push Button Ignition Switch

See **Push Button Ignition Switch** (page 135).

## Stopping the Engine When Your Vehicle is Moving



**WARNING:** Switching off the engine when your vehicle is still moving results in a significant decrease in braking assistance. Higher effort is required to apply the brakes and to stop your vehicle. A significant decrease in steering assistance could also occur. The steering does not lock, but higher effort could be required to steer your vehicle. When you switch the ignition off, some electrical circuits, for example airbags, also turn off. If you unintentionally switch the ignition off, shift into neutral (N) and restart the engine.

### Vehicles with an Ignition Key

1. Shift into neutral and use the brakes to bring your vehicle to a safe stop.
2. Shift into park (P).
3. Turn the key to position **0**.
4. Apply the parking brake.

## Vehicles with a Push Button Ignition Switch

See **Push Button Ignition Switch** (page 135).

## Guarding Against Exhaust Fumes



**WARNING:** Exhaust leaks may result in entry of harmful and potentially lethal fumes into the passenger compartment. If you smell exhaust fumes inside your vehicle, have your vehicle inspected immediately. Do not drive if you smell exhaust fumes.

## Important Ventilating Information

If you stop your vehicle and then leave the engine idling for long periods, we recommend that you do one of the following:

- Open the windows at least 1 in (3 cm).
- Set your climate control to outside air.

## Engine Warning Lamps



Malfunction Indicator Lamp  
Check Engine

If it illuminates when the engine is running this indicates a malfunction. The On Board Diagnostics system has detected a malfunction of the vehicle emission control system.

If it flashes, engine misfire may be occurring. Increased exhaust gas temperatures could damage the catalytic converter or other vehicle components. Avoid heavy acceleration and deceleration and have your vehicle immediately serviced.



Powertrain Warning Lamp

# Starting and Stopping the Engine

If it illuminates when the engine is running this indicates a malfunction. If it flashes when you are driving, immediately reduce the vehicle speed. Avoid heavy acceleration and deceleration and have your vehicle immediately serviced.

If both lamps illuminate when the engine is running, stop your vehicle as soon as it is safe to do so. Continuing to drive your vehicle may cause reduced power or the engine to stop. Switch the ignition off and attempt to restart the engine. Have your vehicle immediately checked.

## Starting System Information Messages

Message	Action
Full Accessory Power Active	Displays if you switch the ignition on and do not start the engine.
Cranking Time Exceeded	Displays if you exceed the starting time limit. You cannot attempt to start the engine for 15 minutes. If you cannot start the engine after 15 minutes passes, have your vehicle immediately checked.
Starting System Fault	Displays if you are unable to start your vehicle with a correctly coded key. The system has detected a fault that requires service. Have your vehicle checked as soon as possible.

## STARTING A FLEX FUEL ENGINE

### Flex Fuel Engine Start System

The speed at which the engine idles immediately after starting is optimized to minimize vehicle emissions and maximize cabin comfort and fuel economy.

**Note:** *You can only attempt to start the engine for a limited amount of time before the starting system temporarily disables. If you exceed the starting time limit, a message may appear and you cannot attempt to start the engine for at least 15 minutes.*

Before starting your vehicle, check the following:

- Make sure the headlamps and electrical accessories are off.
- Make sure the parking brake is on.
- Make sure the transmission is in park (P).

### Vehicles with an Ignition Key

1. Fully press the brake pedal.

**Note:** *Do not touch the accelerator pedal.*

2. Turn the key to position **III**.

If you have difficulty starting the engine when the temperature is below -13°F (-25°C) press the accelerator pedal to the midway point of its travel and try again.

**Note:** *The engine may continue cranking for up to 15 seconds or until it starts.*

**Note:** *The engine takes longer to start at lower temperatures. It may crank for several seconds when very cold.*



# Starting and Stopping the Engine

## Vehicles with Keyless Start

See **Push Button Ignition Switch** (page 135).

## Failure to Start

### Vehicles with an Ignition Key

If the engine does not crank when the ignition key is turned to position III:

1. Fully press the brake pedal.
2. Turn the key to position III until the engine has started.

**Note:** *The total cranking time without engine start is limited to prevent the starter motor overheating. That limit is a function of number of crank attempts and duration. Once the limit is exceeded, further cranking is inhibited until after a period of time, for example 15 to 30 minutes.*

### Vehicles with Keyless Start

See **Push Button Ignition Switch** (page 135).

## Automatic Shutdown

This feature automatically shuts down your vehicle if it has been idling for an extended period. The ignition also turns off in order to save battery power. Before your vehicle shuts down, a message appears in the information display showing a timer counting down from 30 seconds. If you do not intervene within 30 seconds, your vehicle shuts down. Another message appears in the information display to inform you that your vehicle has shut down in order to save fuel. Start your vehicle as you normally do.

### Automatic Shutdown Override

**Note:** *You cannot permanently switch off the automatic shutdown feature. If you switch it off, it turns on each time you switch the ignition on.*

You can stop the shutdown, or reset the timer, at any point before the 30-second countdown has expired by doing any of the following:

- You can reset the timer by interacting with your vehicle (such as pressing the brake pedal or accelerator pedal).
- You can temporarily switch off the shutdown feature any time the ignition is on (for the current ignition cycle only). Use the information display to do so. See **Information Displays** (page 92).
- During the countdown before shutdown, you are prompted to press OK or RESET (depending on your type of information display) to temporarily switch the feature off (for the current ignition cycle only).

## Stopping the Engine When Your Vehicle is Stationary

### Vehicles with an Ignition Key

1. Shift into park (P).
2. Turn the key to position 0.
3. Apply the parking brake.

### Vehicles with Keyless Start

See **Push Button Ignition Switch** (page 135).

## Stopping the Engine When Your Vehicle is Moving



**WARNING:** Switching off the engine when your vehicle is still moving results in a significant decrease in braking assistance. Higher effort is required to apply the brakes and to stop your vehicle. A significant decrease in steering assistance could also occur. The steering does not lock, but higher effort could be

# Starting and Stopping the Engine

required to steer your vehicle. When you switch the ignition off, some electrical circuits, for example airbags, also turn off. If you unintentionally switch the ignition off, shift into neutral (N) and restart the engine.

## Vehicles with an Ignition Key

1. Shift into neutral and use the brakes to bring your vehicle to a safe stop.
2. When your vehicle has stopped, shift into park (P) or neutral and switch the ignition off.
3. Apply the parking brake.

## Vehicles with Keyless Start

See **Push Button Ignition Switch** (page 135).

## Guarding Against Exhaust Fumes



**WARNING:** Exhaust leaks may result in entry of harmful and potentially lethal fumes into the passenger compartment. If you smell exhaust fumes inside your vehicle, have your vehicle inspected immediately. Do not drive if you smell exhaust fumes.

## Important Ventilating Information

If you stop your vehicle and then leave the engine idling for long periods, we recommend that you do one of the following:

- Open the windows at least 1 in (3 cm).
- Set your climate control to outside air.

## STARTING A DIESEL ENGINE

Before starting your vehicle, check the following:

- Make sure the headlamps and electrical accessories are off.
- Make sure the parking brake is on.
- Make sure the transmission is in park (P).

## Vehicles with an Ignition Key

1. Turn the key to position **II**.
2. Wait until the glow plug indicator turns off.
3. Fully press the brake pedal.

**Note:** *Do not touch the accelerator pedal.*

4. Turn the key to position **III**.

**Note:** *Releasing the brake pedal when the engine is starting stops the engine cranking and the ignition returns to on.*

**Note:** *When the temperature is below 5°F (-15°C), you may need to crank the engine for up to 10 seconds.*

**Note:** *You can only attempt to start the engine for a limited amount of time before the starting system temporarily disables. If you exceed the starting time limit, a message may appear and you cannot attempt to start the engine for at least 15 minutes.*

## Vehicles with a Push Button Ignition Switch

See **Push Button Ignition Switch** (page 135).

## Failure to Start

### Vehicles with an Ignition Key

If the engine does not start, do the following:

1. Fully press the brake pedal.

# Starting and Stopping the Engine

2. Apply the parking brake.
3. Shift into park (P).
4. Turn the key to position **III** until the engine starts.

## Vehicles with a Push Button Ignition Switch

See **Push Button Ignition Switch** (page 135).

## Stopping the Engine When Your Vehicle is Stationary

### Vehicles with an Ignition Key

1. Shift into park (P).
2. Turn the key to position **O**.
3. Apply the parking brake.

### Vehicles with a Push Button Ignition Switch

See **Push Button Ignition Switch** (page 135).

## Stopping the Engine When Your Vehicle is Moving



**WARNING:** Switching off the engine when your vehicle is still moving results in a significant decrease in braking assistance. Higher effort is required to apply the brakes and to stop your vehicle. A significant decrease in steering assistance could also occur. The steering does not lock, but higher effort could be required to steer your vehicle. When you switch the ignition off, some electrical circuits, for example airbags, also turn off. If you unintentionally switch the ignition off, shift into neutral (N) and restart the engine.

## Vehicles with an Ignition Key

1. Shift into neutral and use the brakes to bring your vehicle to a safe stop.
2. Shift into park (P).
3. Turn the key to position **O**.
4. Apply the parking brake.

## Vehicles with a Push Button Ignition Switch

See **Push Button Ignition Switch** (page 135).

## Guarding Against Exhaust Fumes



**WARNING:** Exhaust leaks may result in entry of harmful and potentially lethal fumes into the passenger compartment. If you smell exhaust fumes inside your vehicle, have your vehicle inspected immediately. Do not drive if you smell exhaust fumes.

## Important Ventilating Information

If you stop your vehicle and then leave the engine idling for long periods, we recommend that you do one of the following:

- Open the windows at least 1 in (3 cm).
- Set your climate control to outside air.

## Glow Plug Indicator



If it illuminates, wait until it turns off before starting.

## Engine Warning Lamps



Malfunction Indicator Lamp  
Check Engine

# Starting and Stopping the Engine

If it illuminates when the engine is running this indicates a malfunction. The On Board Diagnostics system has detected a malfunction of the vehicle emission control system.

If it flashes, engine misfire may be occurring. Increased exhaust gas temperatures could damage the diesel particulate filter or other vehicle components. Avoid heavy acceleration and deceleration and have your vehicle immediately serviced.



Powertrain Warning Lamp

If it illuminates when the engine is running this indicates a malfunction. If it flashes when you are driving, immediately reduce the vehicle speed. Avoid heavy acceleration and deceleration and have your vehicle immediately serviced.

If both lamps illuminate when the engine is running, stop your vehicle as soon as it is safe to do so. Continuing to drive your vehicle may cause reduced power or the engine to stop. Switch the ignition off and attempt to restart the engine. Have your vehicle immediately checked.

## Starting System Information Messages

Message	Action
Full Accessory Power Active	Displays if you switch the ignition on and do not start the engine.
Cranking Time Exceeded	Displays if your vehicle fails to start.
Starting System Fault	Displays if you are unable to start your vehicle with a correctly coded key. The system has detected a fault that requires service. Have your vehicle checked as soon as possible.

## SWITCHING OFF THE ENGINE

### Vehicles With a Turbocharger



**WARNING:** Do not switch the engine off when it is running at high speed. If you do, the turbocharger will continue running after the engine oil pressure has dropped to zero. This will lead to premature turbocharger bearing wear.

Release the accelerator pedal. Wait until the engine has reached idle speed and then switch it off.

## ENGINE BLOCK HEATER



**WARNING:** Failure to follow engine block heater instructions could result in property damage or serious personal injury.



**WARNING:** Do not use your heater with ungrounded electrical systems or two-pronged adapters. There is a risk of electrical shock.

# Starting and Stopping the Engine



**WARNING:** Do not fully close the hood, or allow it to drop under its own weight when using the engine block heater. This could damage the power cable and may cause an electrical short resulting in fire, injury and property damage.

**Note:** *The heater is most effective when outdoor temperatures are below 0°F (-18°C).*

The heater acts as a starting aid by warming the engine coolant. This allows the climate control system to respond quickly. The equipment includes a heater element (installed in the engine block) and a wire harness. You can connect the system to a grounded 120-volt AC electrical source.

We recommend that you do the following for a safe and correct operation:

- Use a 16-gauge outdoor extension cord that is product certified by Underwriter's Laboratory (UL) or Canadian Standards Association (CSA). This extension cord must be suitable for use outdoors, in cold temperatures, and be clearly marked Suitable for Use with Outdoor Appliances. Do not use an indoor extension cord outdoors. This could result in an electric shock or become a fire hazard.
  - Use as short an extension cord as possible.
  - Do not use multiple extension cords.
  - Make sure that when in operation, the extension cord plug and heater cord plug connections are free and clear of water. This could cause an electric shock or fire.
  - Make sure your vehicle is parked in a clean area, clear of combustibles.
- Make sure the heater, heater cord and extension cord are firmly connected.
  - Check for heat anywhere in the electrical hookup once the system has been operating for approximately 30 minutes.
  - Make sure the system is unplugged and properly stowed before starting and driving your vehicle. Make sure the protective cover seals the prongs of the block heater cord plug when not in use.
  - Make sure the heater system is checked for proper operation before winter.

## Using the Engine Block Heater

Make sure the receptacle terminals are clean and dry prior to use. Clean them with a dry cloth if necessary.

The heater uses 0.4 to 1.0 kilowatt-hours of energy per hour of use. The system does not have a thermostat. It achieves maximum temperature after approximately three hours of operation. Using the heater longer than three hours does not improve system performance and unnecessarily uses electricity.

# Unique Driving Characteristics

## AUTO-START-STOP



**WARNING:** Always switch the ignition off and fully apply the parking brake before carrying out any maintenance or leaving your vehicle. Failure to follow this instruction could result in personal injury or death if the engine restarts.

### Principle of Operation

The system is designed to help reduce fuel consumption and CO<sub>2</sub> emissions by stopping the engine when it is idling, for example at traffic lights. Your vehicle has an enhanced starter motor that is designed for an increased number of engine starts.

The system does not stop the engine under certain conditions, for example:

- If you have opened the driver door.
- If you have unfastened the driver seatbelt.
- If your vehicle is at high altitude.
- If you have switched the heated windshield on.
- If you have shifted into manual (M).
- If your vehicle is on a steep grade.
- If the engine is warming up.
- If the outside temperature is too low or too high.
- If the battery charge is low or the battery temperature is outside the optimal operating range.
- To maintain the interior climate or reduce fogging.
- If you have turned the steering more than 270 degrees.

The system restarts the engine under certain conditions, for example:

- If you have opened the driver door.
- If you have unfastened the driver seatbelt.
- If you switch the heated windshield on.
- If you switch maximum defrost on.
- If you turn the steering wheel.
- If your vehicle starts to roll downhill in neutral.
- To maintain adequate brake assistance.
- To maintain the interior climate or reduce fogging.

**Note:** *The blower motor speed could change when the system restarts the engine.*

### Using Auto-Start-Stop



**WARNING:** Apply the parking brake and shift into park (P) before leaving your vehicle.

### Stopping the Engine

Stop your vehicle and keep your foot on the brake pedal and the transmission in drive (D).

**Note:** *The engine stops if you shift into park (P) or neutral (N) regardless of whether you have your foot on the brake pedal or not.*

**Note:** *Power assist steering turns off when the engine is off.*

### Restarting the Engine

- Release the brake pedal.
- Press the accelerator pedal.
- Shift into drive (D), reverse (R) or manual (M).

# Unique Driving Characteristics

## Switching the System On and Off



The system turns on when you switch the ignition on. Press the switch to switch it off.

**Note:** *OFF* illuminates in the switch.

Press the switch again to switch the system back on.

The auto-start-stop indicator illuminates green when the engine stops. It flashes amber and a message appears when you need to take an action.



The auto-start stop indicator illuminates grey with a strike out when the system is not available.

**Note:** *The system turns off when it detects a malfunction. If it remains off, have your vehicle checked as soon as possible.*

## Information Messages

Message	Condition	Action
Auto Start/Stop Press Brake to Start Engine	The system needs to restart the engine but requires your confirmation.	Press the brake pedal to restart the engine.
Auto Start/Stop Shift to P, then Restart Engine	The system is not functioning.	Shift into park (P) and restart the engine yourself.

## Replacing the Battery

Replace the battery with one of exactly the same specification for the system to function correctly.

# Fuel and Refueling

## SAFETY PRECAUTIONS



**WARNING:** Do not overfill the fuel tank. The pressure in an overfilled tank may cause leakage and lead to fuel spray and fire.



**WARNING:** The fuel system may be under pressure. If you hear a hissing sound near the fuel filler inlet, do not refuel until the sound stops. Otherwise, fuel may spray out, which could cause serious personal injury.



**WARNING:** Fuels can cause serious injury or death if misused or mishandled.



**WARNING:** Fuel may contain benzene, which is a cancer-causing agent.



**WARNING:** When refueling always shut the engine off and never allow sparks or open flames near the fuel tank filler valve. Never smoke or use a cell phone while refueling. Fuel vapor is extremely hazardous under certain conditions. Avoid inhaling excess fumes.

Follow these guidelines when refueling:

- Extinguish all smoking materials and any open flames before refueling your vehicle.
- Always switch the engine off before refueling.
- Automotive fuels can be harmful or fatal if swallowed. Fuel is highly toxic and if swallowed can cause death or permanent injury. If fuel is swallowed immediately call a physician, even if no symptoms are immediately apparent. The toxic effects of fuel may not be apparent for hours.

- Avoid inhaling fuel vapors. Inhaling fuel vapor can lead to eye and respiratory tract irritation. In severe cases, excessive or prolonged breathing of fuel vapor can cause serious illness and permanent injury.
- Avoid getting fuel in your eyes. If you splash fuel in your eyes, immediately remove contact lenses (if worn), flush with water for 15 minutes and seek medical attention. Failure to seek proper medical attention could lead to permanent injury.
- Fuels can be harmful if absorbed through the skin. If you splash fuel on your skin, clothing or both, promptly remove contaminated clothing and thoroughly wash your skin with soap and water. Repeated or prolonged skin contact causes skin irritation.
- Be particularly careful if you are taking Antabuse or other forms of Disulfiram for the treatment of alcoholism. Breathing fuel vapors could cause an adverse reaction, serious personal injury or sickness. Immediately call a physician if you experience any adverse reactions.

## FUEL QUALITY - DIESEL

### **Fuel Requirements - Choosing The Right Fuel: Vehicles Operated Where Ultra Low Sulfur Diesel Fuel Is Required (United States/Canada/Puerto Rico/U.S. Virgin Islands And Other Locales)**

**Note:** *Your warranty will not cover damage caused by using an improper type of fuel or fuel additive.*



# Fuel and Refueling

**Note:** Do not blend used engine oil with diesel fuel under any circumstances. Blending used oil with the fuel will significantly increase your vehicle's exhaust emissions and reduce engine life due to increased internal wear.

You should use Ultra-Low Sulfur Diesel fuel (also known as ULSD) designated as number 1-D or 2-D with a maximum of 15-ppm sulfur in your diesel vehicle. You may operate your vehicle on diesel fuels containing up to 20% biodiesel, also known as B20. These fuels should meet the ASTM D975 diesel or the ASTM D7467 B6-B20 biodiesel industry specifications. Outside of North America, use fuels meeting EN590 or equivalent local market standard.



Using low sulfur diesel fuel (16-500 ppm) or high sulfur diesel fuel (greater than 500 ppm) in your diesel engine will cause certain emission components to malfunction which may also cause the service engine soon light to illuminate indicating an emissions-related concern.

Diesel fuel is adjusted seasonally for cold temperature. For best results at temperatures below 19°F (-7°C), it is recommended to use a diesel fuel which has been seasonally adjusted for the ambient conditions.

## Fuel Requirements - Choosing The Right Fuel: Vehicles Operated Where Ultra Low Sulfur Diesel Fuel Is Not Required

For the engine to operate reliably on low-sulfur or high-sulfur diesel fuel, the engine must be a factory built high-sulfur engine (available as a dealer order option for select markets) or an ultra low sulfur diesel fuel configured engine that has been retrofitted for high-sulfur diesel fuel using Ford Motor Company dealer service parts.

Failure to use retrofit components other than those available through your authorized dealer will result in coolant system damage, engine overheating, selective catalyst reduction system or diesel particulate filter damage and possible base engine damage.

Use only a diesel engine configured for use with high sulfur diesel fuel in markets with diesel fuel that has sulfur content greater than 15 ppm. Using low sulfur diesel fuel (16-500 ppm) or high sulfur diesel fuel (greater than 500 ppm) in a diesel engine designed to use only Ultra Low Sulfur Diesel fuel may result in damage to engine emission control devices and the aftertreatment system, potentially rendering the vehicle inoperable.

Vehicles with engines configured for use with high sulfur diesel fuel are only available for sale in countries where ultra low sulfur diesel fuel is generally not available or mandated by the government. Vehicles originally sold in a ultra low sulfur diesel fuel market that are subsequently exported to non- ultra low sulfur diesel fuel markets will need to be retrofitted (at the customer's expense using Ford authorized dealer service parts) in order to be reliably operated on non- ultra low sulfur diesel fuel.

## Biodiesel



**WARNING:** Do not mix diesel with gasoline, gasohol or alcohol. This could cause an explosion.

# Fuel and Refueling

**Note:** Do not use home heating oil, agricultural fuel, raw fats and oils, waste cooking greases, biodiesel greater than 20% or any diesel not intended for highway use. Damage to the fuel injection system, engine and exhaust catalyst, and diesel particulate filter can occur if you use an improper fuel. Red dye is used to identify fuels intended for agricultural and non-highway use.

You may operate your vehicle on diesel fuels containing up to 20% biodiesel, also known as B20.

Biodiesel fuel is a chemically converted product from renewable fuel sources, such as vegetable oils, animal fats and waste cooking greases.

To help achieve acceptable engine performance and durability when using biodiesel in your vehicle:

- Confirm the biodiesel content of the fuel to be B20 (20% biodiesel) or less
- Only use biodiesel fuel of good quality that complies with industry standards
- Follow the recommended service maintenance intervals. See **General Maintenance Information** (page 416).
- Do not store biodiesel fuel in the fuel tank for more than 1 month
- Consider changing brands or reducing biodiesel content if you have cold temperature fuel gelling issues or a frequent LOW FUEL PRESSURE message appearing

Use of biodiesel in concentrations greater than 20% may cause damage to your vehicle, including engine and/or exhaust after-treatment hardware (exhaust catalyst and particulate filter) failures. Concentrations greater than 20% can also cause fuel filter restrictions that may result in a lack of power or damage to fuel system components, including fuel pump and fuel injector failures.

SAE 5W-40 oil is recommended for fuels with greater than 5% biodiesel (B5). For more information about oil change intervals and other maintenance when operating on biodiesel. See **Special Operating Conditions Scheduled Maintenance** (page 422).

Look for a label on the fuel pump to confirm the amount of biodiesel contained in a diesel fuel. Biodiesel content is often indicated with the letter B followed by the percent of biodiesel in the fuel. For example, B20 indicates a fuel containing 20% biodiesel. Ask the service station attendant to confirm the biodiesel content of a diesel fuel if you do not see a label on the fuel pump.

Biodiesel fuels degrade more easily than diesel fuels not containing biodiesel and should not be stored in the fuel tank for more than 1 month. If you plan to park or store your vehicle for more than 1 month, then you should empty your vehicle fuel tank of biodiesel fuel. You should fill the tank with a pure petroleum-based diesel fuel and run your vehicle for a minimum of 30 minutes.

**Note:** Degraded or oxidized biodiesel can damage fuel system seals and plastics and corrode steel parts.

During cold weather, if you have problems operating on biodiesel, you may need to use a diesel fuel with lower biodiesel content, try another brand, or discontinue the use of biodiesel.

## Diesel Fuel Additives

It should not be necessary to add any aftermarket additives to your fuel if you use a high quality diesel fuel that conforms to ASTM industry specifications. Aftermarket additives can damage the fuel injector system or engine.

# Fuel and Refueling

Use Motorcraft® cetane booster or an equivalent cetane booster additive if you suspect fuel has low cetane. Use Motorcraft® anti-gel & performance improver or an equivalent additive if there is fuel gelling.

Do not use alcohol-based additives to improve cetane quality, to prevent fuel gelling or any other use. The use of alcohol additives may result in damage to the fuel injectors and system.

Your warranty may not cover repairs needed to correct the effects of using an aftermarket product that does not meet Ford specifications in your fuel.

## FUEL QUALITY - GASOLINE

### Choosing the Right Fuel

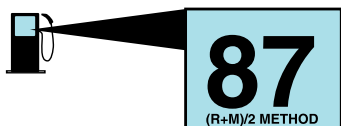

E161513

Your vehicle is designed to operate on regular unleaded gasoline with a minimum pump (R+M)/2 octane rating of 87.

Some fuel stations, particularly those in high altitude areas, offer fuels posted as regular unleaded gasoline with an octane rating below 87. The use of these fuels could result in engine damage that will not be covered by the vehicle warranty.

For best overall vehicle and engine performance, premium fuel with an octane rating of 91 or higher is recommended. The performance gained by using premium fuel is most noticeable in hot weather as well as other conditions, for example when towing a trailer. See **Towing** (page 230).

Do not be concerned if the engine sometimes knocks lightly. However, if the engine knocks heavily while using fuel with the recommended octane rating, contact an authorized dealer to prevent any engine damage.

We recommend Top Tier detergent gasolines, where available to help minimize engine deposits and maintain optimal vehicle and engine performance. For additional information, refer to [www.toptiergas.com](http://www.toptiergas.com).

**Note:** *Use of any fuel for which the vehicle was not designed can impair the emission control system, cause loss of vehicle performance, and cause damage to the engine which may not be covered by the vehicle Warranty.*

Do not use:

- Diesel fuel.
- Fuels containing kerosene or paraffin.
- Fuel containing more than 15% ethanol or E85 fuel.
- Fuels containing methanol.
- Fuels containing metallic-based additives, including manganese-based compounds.
- Fuels containing the octane booster additive, methylcyclopentadienyl manganese tricarbonyl (MMT).
- Leaded fuel, using leaded fuel is prohibited by law.

The use of fuels with metallic compounds such as methylcyclopentadienyl manganese tricarbonyl (commonly known as MMT), which is a manganese-based fuel additive, will impair engine performance and affect the emission control system.

# Fuel and Refueling

## FUEL QUALITY - E85

### Choosing the Right Fuel - Flex Fuel Vehicles

Flex fuel vehicles have one of the following identifiers:

- Yellow fuel filler cap.
- Yellow bezel around the fuel filler inlet.
- Yellow fuel filler housing.
- Yellow E85 label on the fuel tank filler door.

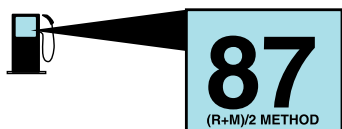

E161513

Your vehicle is designed to operate on regular unleaded gasoline with a minimum pump (R+M)/2 octane rating of 87 or regular unleaded gasoline blended with a maximum of 85% ethanol (E85).

Some fuel stations, particularly those in high altitude areas, offer fuels posted as regular unleaded gasoline with an octane rating below 87. The use of these fuels could result in engine damage that will not be covered by the vehicle warranty.

For best overall vehicle and engine performance, premium fuel with an octane rating of 91 or higher is recommended. The performance gained by using premium fuel is most noticeable in hot weather as well as other conditions, for example when towing a trailer. See **Towing** (page 230).

Do not be concerned if the engine sometimes knocks lightly. However, if the engine knocks heavily while using fuel with the recommended octane rating, contact an authorized dealer to prevent any engine damage.

We recommend Top Tier detergent gasolines, where available to help minimize engine deposits and maintain optimal vehicle and engine performance. For additional information, refer to [www.toptiergas.com](http://www.toptiergas.com).

**Note:** *Use of any fuel for which the vehicle was not designed can impair the emission control system, cause loss of vehicle performance, and cause damage to the engine which may not be covered by the vehicle Warranty.*

Do not use:

- Diesel fuel.
- Fuels containing kerosene or paraffin.
- Fuels containing more than 85% ethanol or E100 fuel.
- Fuels containing methanol.
- Fuels containing metallic-based additives, including manganese-based compounds.
- Fuels containing the octane booster additive, methylcyclopentadienyl manganese tricarbonyl (MMT).
- Leaded fuel, using leaded fuel is prohibited by law.

The use of fuels with metallic compounds such as methylcyclopentadienyl manganese tricarbonyl (commonly known as MMT), which is a manganese-based fuel additive, will impair engine performance and affect the emission control system.

# Fuel and Refueling

## Switching Between E85 and Gasoline

We do not recommend repeatedly alternating between E85 and gasoline. If you switch from using E85 to gasoline, or from gasoline to E85, add as much fuel as possible, at least half a tank. Drive your vehicle immediately for a minimum of 5 mi (8 km) to allow it to adapt to the change in ethanol concentration. If you use E85 exclusively, we recommend that you fill the fuel tank with regular unleaded gasoline at each scheduled oil change.

## FUEL FILLER FUNNEL LOCATION

The fuel filler funnel is in the glove compartment.

## RUNNING OUT OF FUEL

Running out of fuel can cause damage not covered by the vehicle Warranty.

If your vehicle runs out of fuel:

- Add a minimum of 1.3 gal (5 L) of fuel to restart the engine.
- You may need to switch the ignition from off to on several times after refueling to allow the fuel system to pump the fuel from the tank to the engine. When restarting, cranking time takes a few seconds longer than normal.

**Note:** *If your vehicle is on a steep slope, more fuel may be required.*

## Filling a Portable Fuel Container



**WARNING:** Flow of fuel through a fuel pump nozzle can produce static electricity. This can cause a fire if you are filling an ungrounded fuel container.

Use the following guidelines to avoid electrostatic charge build-up, which can produce a spark, when filling an ungrounded fuel container:

- Only use an approved fuel container to transfer fuel to your vehicle. Place the container on the ground when filling it.
- Do not fill a fuel container when it is inside your vehicle (including the cargo area).
- Keep the fuel pump nozzle in contact with the fuel container when filling it.
- Do not use a device that holds the fuel pump nozzle lever in the fill position.

## Adding Fuel From a Portable Fuel Container



**WARNING:** Do not insert the nozzle of a fuel container or an aftermarket funnel into the fuel filler neck. This may damage the fuel system filler neck or its seal and cause fuel to run onto the ground.



**WARNING:** Do not try to pry open or push open the capless fuel system with foreign objects. This could damage the fuel system and its seal and cause injury to you or others.



**WARNING:** Do not dispose of fuel in the household refuse or the public sewage system. Use an authorized waste disposal facility.

# Fuel and Refueling

When refueling the vehicle fuel tank from a fuel container, use the fuel filler funnel included with your vehicle. See **Fuel Filler Funnel Location** (page 153).

**Note:** Do not use aftermarket funnels as they may not work with the capless fuel system and can damage it.

When refueling the vehicle fuel tank from a fuel container, do the following:

1. Fully open the fuel filler door.
2. Fully insert the fuel filler funnel into the fuel filler inlet.



3. Add fuel to your vehicle from the fuel container.
4. Remove the fuel filler funnel.
5. Fully close the fuel filler door.
6. Clean the fuel filler funnel and place it back in your vehicle or correctly dispose of it.

**Note:** Extra funnels can be purchased from an authorized dealer if you choose to dispose of the funnel.

## REFUELING

### Refueling System Overview

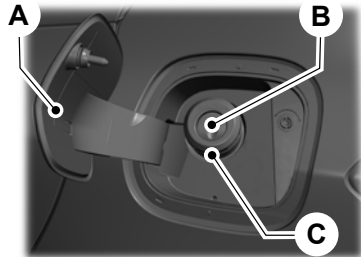

- A Fuel filler door.
- B Fuel tank filler valve.
- C Fuel tank filler pipe.

Your vehicle does not have a fuel tank filler cap.

# Fuel and Refueling

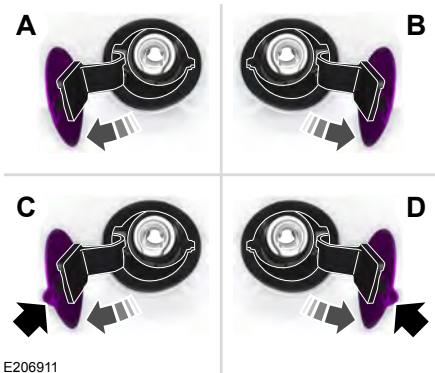

E206911

- A Left-hand side. To open the fuel filler door, press the center rear edge of the fuel filler door and then release.
- B Right-hand side. To open the fuel filler door, press the center rear edge of the fuel tank filler door and then release.
- C Left-hand side. Pull the rear of the fuel filler door to open it.
- D Right-hand side. Pull the rear of the fuel filler door to open it.

## Refueling Your Vehicle

**WARNING:** When refueling always shut the engine off and never allow sparks or open flames near the fuel tank filler valve. Never smoke or use a cell phone while refueling. Fuel vapor is extremely hazardous under certain conditions. Avoid inhaling excess fumes.

**WARNING:** The fuel system may be under pressure. If you hear a hissing sound near the fuel filler inlet, do not refuel until the sound stops. Otherwise, fuel may spray out, which could cause serious personal injury.

**WARNING:** Do not pry open the fuel tank filler valve. This could damage the fuel system. Failure to follow this instruction could result in fire, personal injury or death.

**WARNING:** Do not remove the fuel pump nozzle from its fully inserted position when refueling.

**WARNING:** Stop refueling when the fuel pump nozzle automatically shuts off for the first time. Failure to follow this will fill the expansion space in the fuel tank and could lead to fuel overflowing.

**WARNING:** Do not overfill the fuel tank. The pressure in an overfilled tank may cause leakage and lead to fuel spray and fire.

**WARNING:** Wait at least five seconds before removing the fuel pump nozzle to allow any residual fuel to drain into the fuel tank.

1. Fully open the fuel filler door.
2. Select the correct fuel pump nozzle for your vehicle.

# Fuel and Refueling

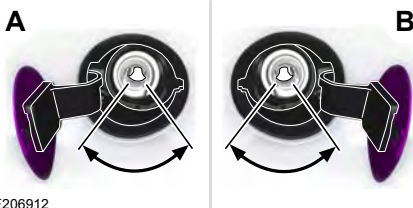
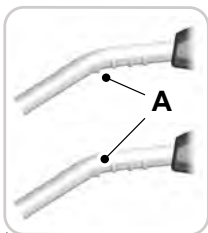

E206912

5. Operate the fuel pump nozzle within the area shown.



E119081

6. When you finish refueling slightly raise the fuel pump nozzle and slowly remove it.
7. Fully close the fuel filler door.

Do not attempt to start the engine if you have filled the fuel tank with incorrect fuel. Incorrect fuel use could cause damage not covered by the vehicle Warranty. Have your vehicle immediately checked.

## Refueling System Warning (If Equipped)

If the fuel tank filler valve does not fully close, a message could appear in the information display.

Message
Check Fuel Fill Inlet

If the message appears, do the following:

1. Stop your vehicle as soon as it is safe to do so and switch the engine off.
2. Shift into park (P) or neutral (N).



E139202

3. Insert the fuel pump nozzle up to the first notch on the nozzle A. Keep the fuel pump nozzle resting on the fuel tank filler pipe.

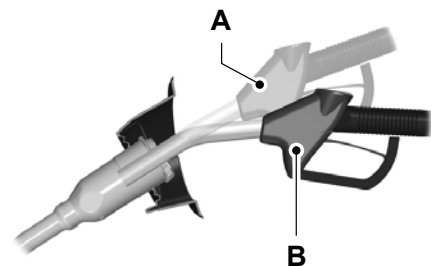

E139203

4. Hold the fuel pump nozzle in position B when refueling. Holding the fuel pump nozzle in position A can affect the flow of fuel and shut off the fuel pump nozzle before the fuel tank is full.



# Fuel and Refueling

---

3. Apply the parking brake.
4. Fully open the fuel filler door.
5. Check the fuel tank filler valve for any debris that may be restricting its movement.
6. Remove any debris from the fuel tank filler valve.
7. Fully insert a fuel pump nozzle or the fuel filler funnel provided with your vehicle into the fuel filler pipe. See **Fuel Filler Funnel Location** (page 153). This action should dislodge any debris that may be preventing the fuel tank filler valve from fully closing.
8. Remove the fuel pump nozzle or fuel filler funnel from the fuel filler pipe.
9. Fully close the fuel filler door.

**Note:** *The message may not immediately reset. If the message continues to appear and a warning lamp illuminates, have your vehicle checked as soon as possible.*

## FUEL CONSUMPTION

### Advertised Capacity

The advertised capacity is the maximum amount of fuel that you can add to the fuel tank after running out of fuel. Included in the advertised capacity is an empty reserve. The empty reserve is an unspecified amount of fuel that remains in the fuel tank when the fuel gauge indicates empty.

**Note:** *The amount of fuel in the empty reserve varies and should not be relied upon to increase driving range.*

### Fuel Economy

Your vehicle calculates fuel economy figures through the trip computer average fuel function. See **General Information** (page 92).

The first 1,000 mi (1,500 km) of driving is the break-in period of the engine. A more accurate measurement is obtained after 2,000 mi (3,000 km).

### Impacting Fuel Economy

- Incorrect tire inflation pressures.
- Fully loading your vehicle.
- Carrying unnecessary weight.
- Adding certain accessories to your vehicle such as bug deflectors, rollbars or light bars, running boards and ski racks.
- Using fuel blended with alcohol. See **Fuel Quality** (page 151).
- Fuel economy may decrease with lower temperatures.
- Fuel economy may decrease when driving short distances.
- You may get better fuel economy when driving on flat terrain than when driving on hilly terrain.

# Engine Emission Control

## EMISSION LAW



**WARNING:** Do not remove or alter the original equipment floor covering or insulation between it and the metal floor of the vehicle. The floor covering and insulation protect occupants of the vehicle from the engine and exhaust system heat and noise. On vehicles with no original equipment floor covering insulation, do not carry passengers in a manner that permits prolonged skin contact with the metal floor. Failure to follow these instructions may result in fire or personal injury.

U.S. federal laws and certain state laws prohibit removing or rendering inoperative emission control system components. Similar federal or provincial laws may apply in Canada. We do not approve of any vehicle modification without first determining applicable laws.



Tampering with emissions control systems including related sensors or the Diesel Exhaust Fluid system can result in reduced engine power and the illumination of the service engine soon light.

## Tampering With a Noise Control System

Federal laws prohibit the following acts:

- Removal or rendering inoperative by any person other than for purposes of maintenance.
- Repair or replacement of any device or element of the design incorporated into a new vehicle for the purpose of noise control prior to its sale or delivery to the ultimate purchaser or while it is in use.
- The use of the vehicle after any person removes or renders inoperative any device or element of the design.

The U.S. Environmental Protection Agency may presume to constitute tampering as follows:

- Removal of hood blanket, fender apron absorbers, fender apron barriers, underbody noise shields or acoustically absorptive material.
- Tampering or rendering inoperative the engine speed governor, to allow engine speed to exceed manufacturer specifications.

If the engine does not start, runs rough, experiences a decrease in engine performance, experiences excess fuel consumption or produces excessive exhaust smoke, check for the following:

- A plugged or disconnected air inlet system hose.
- A plugged engine air filter element.
- Water in the fuel filter and water separator.
- A clogged fuel filter.
- Contaminated fuel.
- Air in the fuel system, due to loose connections.
- An open or pinched sensor hose.
- Incorrect engine oil level.

# Engine Emission Control

- Incorrect fuel for climatic conditions.
- Incorrect engine oil viscosity for climactic conditions.

**Note:** *Some vehicles have a lifetime fuel filter that is integrated with the fuel tank. Regular maintenance or replacement is not needed.*

**Note:** *If these checks do not help you correct the concern, have your vehicle checked as soon as possible.*

## Noise Emissions Warranty, Prohibited Tampering Acts and Maintenance

On January 1, 1978, Federal regulation became effective governing the noise emission on trucks over 10,000 lb (4,536 kg) Gross Vehicle Weight Rating (GVWR). The preceding statements concerning prohibited tampering acts and maintenance, and the noise warranty found in the Warranty Guide, are applicable to complete chassis cabs over 10,000 lb (4,536 kg) GVWR.

## CATALYTIC CONVERTER



**WARNING:** Do not park, idle or drive your vehicle on dry grass or other dry ground cover. The emission system heats up the engine compartment and exhaust system, creating the risk of fire.



**WARNING:** The normal operating temperature of the exhaust system is very high. Never work around or attempt to repair any part of the exhaust system until it has cooled. Use special care when working around the catalytic converter. The catalytic converter heats up to a very high temperature after only a short period of engine operation and stays hot after the engine is switched off.

Your vehicle has various emission control components and a catalytic converter that enables it to comply with applicable exhaust emission standards.

To avoid damaging the catalytic converter:

- Do not crank the engine for more than 10 seconds at a time.
- Do not run the engine with a spark plug lead disconnected.
- Do not push-start or tow-start your vehicle. Use booster cables. See **Jump Starting the Vehicle** (page 243).
- Do not switch the ignition off when your vehicle is moving.
- Do not use leaded fuel.

**Note:** *Resulting component damage may not be covered by the vehicle Warranty.*

## On-Board Diagnostics System

Your vehicle has an on-board diagnostics system that monitors the emission control system. If any of the following warning lamps illuminate, this may indicate that the on-board diagnostics system has detected an emission control system malfunction.



Engine coolant temperature warning lamp.



Battery charging condition warning lamp.



Malfunction indicator lamp.  
Service engine soon warning lamp.

Continuing to drive your vehicle may cause reduced power or the engine to stop. Failure to respond to a warning lamp may cause component damage not covered by the vehicle Warranty. Have your vehicle checked as soon as possible.

# Engine Emission Control

See **Warning Lamps and Indicators** (page 88).

## SELECTIVE CATALYTIC REDUCTANT SYSTEM

Your vehicle has a selective catalytic reductant system to help reduce exhaust emission levels by injecting diesel exhaust fluid into the exhaust system. The engine may not start if you tamper with or disable the selective catalytic reductant system.

For the system to correctly operate, you must maintain the fluid level. The minimum fluid refill quantity required to restart the engine is 1.3 gal (5 L).

**Note:** *If your vehicle is on a gradient, the minimum fluid refill quantity required to restart the engine may be greater than 1.3 gal (5 L).*

### Diesel Exhaust Fluid Guidelines

- Do not put in the vehicle fuel tank. This can cause engine damage not covered by the vehicle Warranty.
- Do not overfill the tank.
- Do not dilute with water or any other liquid.
- Do not re-use an empty fluid container.
- Do not store in direct sunlight.
- Store at temperatures between 23°F (-5°C) and 68°F (20°C).
- Do not store fluid containers in your vehicle.
- The fluid is non-flammable, non-toxic, colorless and water-soluble.

## Filling the Diesel Exhaust Fluid Tank



E204215

The diesel exhaust fluid tank filler pipe is next to the fuel tank filler pipe and has a blue cap. Fill the tank using a fluid pump at a diesel exhaust fluid filling station or a diesel exhaust fluid container.

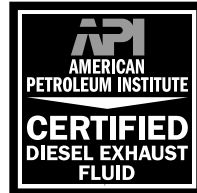

E163354

Only use diesel exhaust fluid that is certified by the American Petroleum Institute (API). Non-certified diesel exhaust fluid use can cause damage not covered by the vehicle Warranty.

**Note:** *Wash off any fluid that may have spilled on to a painted surface with soapy water.*

# Engine Emission Control

## Filling in Cold Climates

Diesel exhaust fluid may freeze when the temperature is below 12°F (-11°C). Your vehicle has a preheating system which allows the fluid to operate below 12°F (-11°C). If you overfill the diesel exhaust fluid tank and the fluid freezes, it may cause damage not covered by the vehicle Warranty.

## Filling the Diesel Exhaust Fluid Tank Using a Fuel Station Pump

**WARNING:** Keep diesel exhaust fluid out of reach of children. Avoid contact with skin, eyes or clothing. In case of contact with your eyes, flush immediately with water and get prompt medical attention. In case of contact with your skin, clean immediately with soap and water. If you swallow any diesel exhaust fluid, drink plenty of water, call a physician immediately.

**WARNING:** Only refill the diesel exhaust fluid tank in a well ventilated area. When you remove the diesel exhaust fluid tank filler cap or a diesel exhaust fluid container cap, ammonia vapors may escape. Ammonia vapors can be irritating to skin, eyes and mucous membranes. Inhaling ammonia vapors can cause burning to the eyes, throat and nose and cause coughing and watery eyes.

Filling the diesel exhaust fluid tank using a fuel station pump is similar to refueling your vehicle.

1. Fully open the fuel filler door.

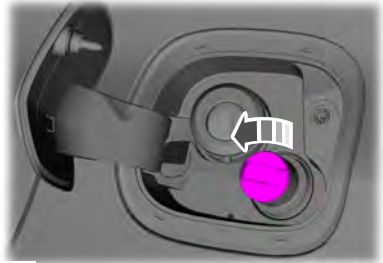

E268809

2. Remove the diesel exhaust fluid tank filler cap.
3. Fully insert the diesel exhaust fluid pump nozzle.

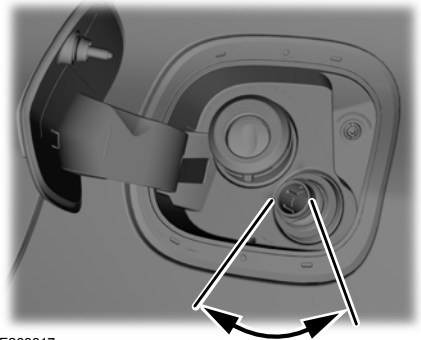

E268817

4. Operate the pump nozzle within the area shown.

**Note:** *The pump nozzle shuts off when the tank is full.*

5. Slightly raise the diesel exhaust fluid pump nozzle and then slowly remove it.
6. Replace the diesel exhaust fluid tank filler cap. Turn it clockwise until you feel a strong resistance.

# Engine Emission Control

Do not attempt to start the engine if you have filled the diesel exhaust fluid tank with incorrect fluid. Incorrect diesel exhaust fluid use could cause damage not covered by the vehicle Warranty. Have your vehicle immediately checked.

## Filling the Diesel Exhaust Fluid Tank Using a Container

**WARNING:** Keep diesel exhaust fluid out of reach of children. Avoid contact with skin, eyes or clothing. In case of contact with your eyes, flush immediately with water and get prompt medical attention. In case of contact with your skin, clean immediately with soap and water. If you swallow any diesel exhaust fluid, drink plenty of water, call a physician immediately.

**WARNING:** Only refill the diesel exhaust fluid tank in a well ventilated area. When you remove the diesel exhaust fluid tank filler cap or a diesel exhaust fluid container cap, ammonia vapors may escape. Ammonia vapors can be irritating to skin, eyes and mucous membranes. Inhaling ammonia vapors can cause burning to the eyes, throat and nose and cause coughing and watery eyes.

Always follow the manufacturer's instructions.

1. Remove the fluid container cap.
2. Place the spout on to the container and tighten it until you feel a strong resistance.

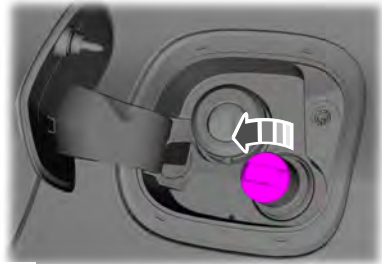

E268809

3. Remove the diesel exhaust fluid tank filler cap.
4. Insert the spout into the diesel exhaust fluid tank filler pipe until the seal on the spout fully seats.
5. Pour the fluid into the tank.

**Note:** *The fluid stops flowing when the tank is full.*

6. Return the container to the vertical position slightly below the diesel exhaust fluid tank filler pipe.
7. Allow any fluid remaining in the spout to drain back into the container.
8. Remove the spout from the diesel exhaust fluid tank filler pipe.
9. Remove the spout from the diesel exhaust fluid container and replace the cap.
10. Replace the diesel exhaust fluid tank filler cap. Turn it clockwise until you feel a strong resistance.

Do not attempt to start the engine if you have filled the diesel exhaust fluid tank with incorrect fluid. Incorrect diesel exhaust fluid use could cause damage not covered by the vehicle Warranty. Have your vehicle immediately checked.

# Engine Emission Control

## Selective Catalytic Reductant System Warning Lamp



The warning lamp illuminates if the system detects the diesel exhaust fluid level is low or if there is a system malfunction.

If the warning lamp illuminates, the information display messages give you an indication whether the concern is fluid related or if there is a selective catalytic reductant system malfunction. If the warning lamp illuminates when your vehicle is moving, and the fluid is at a sufficient level, this indicates a system malfunction. Have your vehicle checked as soon as possible.

**Note:** *When filling the diesel exhaust fluid tank from empty, there may be a short period before the increased diesel exhaust fluid level is registered.*

## DIESEL PARTICULATE FILTER



**WARNING:** Do not park or idle your vehicle over dry leaves, dry grass or other combustible materials. The regeneration process creates very high exhaust gas temperatures and the exhaust will radiate a considerable amount of heat during and after regeneration and after you have switched the engine off. This is a potential fire hazard.



**WARNING:** The normal operating temperature of the exhaust system is very high. Never work around or attempt to repair any part of the exhaust system until it has cooled. Use special care when working around the diesel oxidation

catalytic converter or the diesel particulate filter. The diesel oxidation catalytic converter and the diesel particulate filter heat up to very high temperatures after only a short period of engine operation and remain hot after you switch the engine off.

Your vehicle has various emission control components and a diesel particulate filter that enables it to comply with applicable exhaust emission standards. It filters harmful diesel particulates, for example soot from the exhaust gas.

To avoid damaging the diesel particulate filter:

- Do not crank the engine for more than 10 seconds at a time.
- Do not push-start or tow-start your vehicle. Use booster cables. See **Jump Starting the Vehicle** (page 243).
- Do not switch the ignition off when your vehicle is moving.
- Do not ignore warning lamps or information messages regarding exhaust system cleaning and regeneration.

**Note:** *This could result in damage not covered by the vehicle Warranty.*

## On-Board Diagnostics System

Your vehicle has an on-board diagnostics system that monitors the emission control system. If any of the following warning lamps illuminate, this indicates that the on-board diagnostics system has detected an emission control system malfunction.



Engine coolant temperature warning lamp.



Ignition warning lamp.

# Engine Emission Control



Malfunction indicator lamp.



Powertrain warning Lamp.



Water in fuel warning lamp.

If you continue to drive your vehicle when the warning lamp is illuminated, the engine could stop without warning. This could result in damage not covered by the vehicle Warranty. Have your vehicle checked as soon as possible.

See **Warning Lamps and Indicators** (page 88).

## Diesel Particulate Filter Automatic Regeneration



**WARNING:** Do not park or idle your vehicle over dry leaves, dry grass or other combustible materials. The regeneration process creates very high exhaust gas temperatures and the exhaust will radiate a considerable amount of heat during and after regeneration and after you have switched the engine off. This is a potential fire hazard.



**WARNING:** The normal operating temperature of the exhaust system is very high. Never work around or attempt to repair any part of the exhaust system until it has cooled. Use special care when working around the diesel oxidation catalytic converter or the diesel particulate filter. The diesel oxidation catalytic converter and the diesel particulate filter heat up to very high temperatures after only a short period of engine operation and remain hot after you switch the engine off.

The diesel particulate filter on your vehicle requires periodic regeneration to maintain correct operation. The emission control system automatically carries out this process. As soot gathers in the system it begins to restrict the filter. The soot that gathers inside the filter is cleaned in two different ways, passive regeneration and active regeneration. Both methods occur automatically and require no actions from the driver. During automatic regeneration, the system cleans the diesel particulate filter by oxidizing the soot. Cleaning happens during normal engine operating conditions at varying levels depending on driving conditions.



Diesel particulate filter warning lamp.

If the diesel particulate filter is near or at saturation, a warning lamp or information message appears in the information display. Drive your vehicle in a manner to allow effective diesel particulate filter cleaning.

The warning lamp continues to illuminate until the automatic regeneration process completes. Continue to drive your vehicle in a manner to allow effective diesel particulate filter cleaning until the warning lamp turns off.

Failure to carry out regeneration when required could result in a clogged diesel particulate filter. If the diesel particulate filter fills beyond the regeneration threshold, the system disables the ability to carry out regeneration. This could result in damage not covered by the vehicle Warranty.

Where vehicle use meets any of the following conditions:

- Driving short distances.
- Prolonged engine idling.



# Engine Emission Control

- Frequently switching the engine on and off.
- High levels of acceleration and deceleration.

We recommend you assist the regeneration process by:

- Avoiding prolonged engine idling.
- Drive your vehicle in a manner to allow effective cleaning. Drive at a steady vehicle speed of 30 mph (48 km/h) or above for approximately 20 minutes.



If the warning lamp illuminates the diesel particulate filter could have become overloaded. Have your vehicle checked as soon as possible.

Automatic regeneration raises the exhaust temperature to eliminate the soot particles. During cleaning soot particles are converted to harmless gasses. Once cleaned the diesel particulate filter continues to trap harmful diesel particles.

If you are driving your vehicle in a manner that allows effective cleaning, a message may appear in the information display to indicate automatic regeneration is in progress.

If you are not driving your vehicle in a manner that allows effective cleaning, a message may appear in the information display to instruct you to drive in a manner that allows automatic regeneration.

The automatic regeneration process is most effective when you drive at a steady vehicle speed of 30 mph (48 km/h) or above for approximately 20 minutes. The frequency and duration of the regeneration process varies by how you drive your vehicle, the outside air temperature and altitude. Frequency varies between 100 mi (160 km) and 310 mi (500 km) and each regeneration process lasts between 10 and 20 minutes.

**Note:** Changes in the engine or exhaust sound may be heard during the regeneration process.

**Note:** During regeneration at low speed or engine idle, you could smell a hot metallic odor and could notice a clicking metallic sound. This is due to the high temperatures reached during the regeneration process. This is normal.

## Diesel Particulate Filter Manual Regeneration (If Equipped)



**WARNING:** Do not park or idle your vehicle over dry leaves, dry grass or other combustible materials. The regeneration process creates very high exhaust gas temperatures and the exhaust will radiate a considerable amount of heat during and after regeneration and after you have switched the engine off. This is a potential fire hazard.



**WARNING:** The normal operating temperature of the exhaust system is very high. Never work around or attempt to repair any part of the exhaust system until it has cooled. Use special care when working around the diesel oxidation catalytic converter or the diesel particulate filter. The diesel oxidation catalytic converter and the diesel particulate filter heat up to very high temperatures after only a short period of engine operation and remain hot after you switch the engine off.



Diesel particulate filter warning lamp.

If the diesel particulate filter is near or at saturation, the warning lamp appears advising you to initiate diesel particulate filter manual regeneration.

# Engine Emission Control

Before you start manual regeneration, do the following:

- Park your vehicle outside of any enclosed structure.
- Make sure the transmission is in park (P) or neutral (N).
- Make sure the parking brake is on.
- Park your vehicle a minimum of 10 ft (3 m) from any obstructions and materials that can easily combust or melt, for example, paper, leaves, fuels, plastics and other dry organic material.
- Make sure there is a minimum of 3.2 gal (12 L) of fuel in the fuel tank.
- Check the engine oil level.
- Check the engine coolant level.

## Manual Regeneration

Where vehicle use has significant engine idle operation, frequent vehicle speed less than 25 mph (40 km/h), or driving short distances where the engine does not fully warm up, manual regeneration allows you to start diesel particulate filter cleaning when the engine is idling.

Use the manual regeneration feature when:

- You are not able to drive in a manner that allows effective automatic cleaning. See **Diesel Particulate Filter Automatic Regeneration**.
- You choose to manually start the regeneration process when the engine is idling.

## To start manual regeneration, from the main menu scroll to:

Message	Action and Description
Settings	Press the <b>OK</b> button or the right arrow button.
Exhaust Filter Full Clean Soon	Press the <b>OK</b> button or the right arrow button.

**Select one of the following:**

**Note:** Changes in the engine or exhaust sound may be heard during the regeneration process.

**Note:** During regeneration at low speed or engine idle, you may smell a hot metallic odor and could notice a clicking metallic sound. This is due to the high temperatures reached during the regeneration process. This is normal.

## Starting Manual Regeneration

You can only start manual regeneration with the engine running at normal operating temperature using the information display. See **Information Messages** (page 94).

**Note:** During the use of manual regeneration, you may observe a light amount of white smoke. This is normal.

**Note:** If you press any pedal during manual regeneration the engine may turn off. To protect the exhaust system you may not be able to restart the engine for 10 minutes.



If a warning illuminates you may not be able to start manual regeneration.

# Engine Emission Control

Message	Action and Description
Exhaust Filter at Limit Clean Now	Press the <b>OK</b> button or the right arrow button. Follow the prompts regarding exhaust position as required to start manual regeneration. Make sure you understand each prompt. The information display confirms that regeneration has started and when it is completed.
Exhaust Filter Over-loaded Clean Now	Press the <b>OK</b> button or the right arrow button. Follow the prompts regarding exhaust position as required to start manual regeneration. Make sure you understand each prompt. The information display confirms that regeneration has started and when it is completed.

**Note:** *You cannot use the manual regeneration until the diesel particulate filter load percentage has reached 100 percent. The diesel particulate filter load percentage fluctuates when driving due to automatic regeneration.*

When you start manual regeneration the engine speed rises to approximately 2000–2500 rpm and the cooling fan speed increases. A change in engine noise due to the cooling fan and engine speed increase may be heard during the regeneration process.

Depending on the amount of soot collected by the diesel particulate filter, the regeneration process varies depending on the outside air temperature and altitude. Manual regeneration may last up to 40 minutes.

When manual regeneration is complete the cooling fan and engine speed return to normal idling. The exhaust system remains very hot for several minutes after regeneration is complete. Do not reposition the vehicle over dry leaves, dry grass or other combustible materials until the exhaust system has had sufficient time to cool.

## **Interrupt or Cancel Manual Regeneration**

You can interrupt or cancel manual regeneration by switching the engine off. It may be possible to interrupt or cancel manual regeneration by pressing any pedal.

**Note:** *To protect the exhaust system you may not be able to restart the engine for 10 minutes.*

Depending on the amount of time allowed for manual regeneration to operate, soot may not have had sufficient time to be eliminated. The exhaust system may still be very hot for several minutes after regeneration.

If you switch the engine off during manual regeneration, turbo charger flutter occurs. This is a consequence of switching a diesel engine off during turbo charger boost operation, which is normal.

## **Manual Regeneration with Automatic Regeneration Control**

Where vehicle use has significant engine idle operation, frequent vehicle speed less than 25 mph (40 km/h), or driving short distances where the engine does not fully warm up, automatic regeneration could not sufficiently clean the diesel particulate filter. You can switch automatic regeneration off until you can drive your

# Engine Emission Control

---

vehicle in a manner to allow effective cleaning, for example at a steady vehicle speed of 30 mph (48 km/h) or above for

approximately 20 minutes. You can then switch automatic regeneration back on to clean the diesel particulate filter.

## To switch the automatic regeneration control on and off, from the main menu scroll to:

Message	Action and Description
Information	Press the <b>OK</b> button or the right arrow button.
Driver Assist	Press the <b>OK</b> button or the right arrow button.
Auto Exhaust Cleaning Off	Check the box to switch automatic regeneration off. Uncheck the box to switch automatic regeneration on.

# Transmission

## AUTOMATIC TRANSMISSION - 6-SPEED AUTOMATIC TRANSMISSION



**WARNING:** Do not apply the brake pedal and accelerator pedal simultaneously. Applying both pedals simultaneously for more than a few seconds will limit engine performance, which may result in difficulty maintaining speed in traffic and could lead to serious injury.

### Selector Lever Positions

The instrument cluster displays the current gear.

#### Park (P)

In park (P), power is not transmitted to the driven wheels and the transmission is locked. You can start the engine with the transmission in this position.

Shift into park (P) only when your vehicle is stationary.

#### Reverse (R)

Shift into reverse (R) only when your vehicle is stationary and the engine is at idle speed.

#### Neutral (N)

In neutral (N), power is not transmitted to the driven wheels but the transmission is not locked. You can start the engine with the transmission in this position.

#### Drive (D)

Drive (D) is the normal position for driving.

#### Sport (S)

In sport (S), the transmission selects the optimum gear for best performance.

### SelectShift™ (if Equipped)

#### About SelectShift™

Use this feature to upshift or downshift using the buttons on the selector lever.

#### Using SelectShift™

Shift into sport (S). Press the **+** button to switch the feature on.

- Press the **+** button to upshift.
- Press the **-** button to downshift.

Shift into another gear to switch the feature off.

### Brake Shift Interlock

#### About Brake Shift Interlock

Brake shift interlock prevents you from shifting out of park (P) when you have switched the ignition on and not pressed the brake pedal.

#### Shifting Out of Park (P)



**WARNING:** Do not drive your vehicle until you verify that the stoplamps are working.



**WARNING:** If the parking brake is fully released, but the brake warning lamp remains illuminated, the brakes may not be working properly. Have your vehicle checked as soon as possible.

Use the brake shift interlock lever to move the selector lever out of park (P) if you cannot start the engine.

In the event of an electrical malfunction, it is possible that a fuse has blown or the stoplamps are not working. See **Fuse Specification Chart** (page 254).

# Transmission

If the vehicle battery has no charge, jump start your vehicle. See **Jump Starting the Vehicle** (page 243).

**⚠ WARNING:** When doing this procedure, you need to take the transmission out of park (P) which means your vehicle can roll freely. To avoid unwanted vehicle movement, always fully apply the parking brake prior to doing this procedure. Use wheels chocks if appropriate.

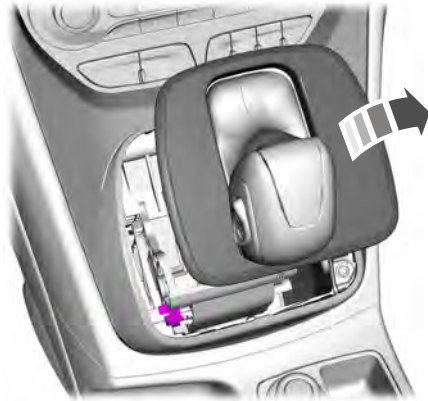

E275061

1. Using a flat-bladed screwdriver, remove the panel.



E142627

2. Locate the brake shift interlock lever.



E174827

3. Push the brake shift interlock lever toward the rear of your vehicle and hold it there.
4. Move the selector lever from park (P) to neutral (N).
5. Install the panel.
6. Press the brake pedal, start the engine and release the parking brake.

**Note:** Have your vehicle checked as soon as possible.

# Transmission

## **AUTOMATIC TRANSMISSION - 8-SPEED AUTOMATIC TRANSMISSION**



**WARNING:** Do not apply the brake pedal and accelerator pedal simultaneously. Applying both pedals simultaneously for more than a few seconds will limit engine performance, which may result in difficulty maintaining speed in traffic and could lead to serious injury.

### **Selector Lever Positions**

The instrument cluster displays the current gear.

#### **Park (P)**

In park (P), power is not transmitted to the driven wheels and the transmission is locked. You can start the engine with the transmission in this position.

Shift into park (P) only when your vehicle is stationary.

#### **Reverse (R)**

Shift into reverse (R) only when your vehicle is stationary and the engine is at idle speed.

#### **Neutral (N)**

In neutral (N), power is not transmitted to the driven wheels but the transmission is not locked. You can start the engine with the transmission in this position.

#### **Drive (D)**

Drive (D) is the normal position for driving.

### **Manual (M)**

In manual (M), you can upshift or downshift using the buttons on the selector lever.

### **SelectShift™**

#### **About SelectShift™**

Use this feature to upshift or downshift using the buttons on the selector lever.

#### **Using SelectShift™**

Shift into manual (M) to switch the feature on.

- Press the **+** button to upshift.
- Press the **-** button to downshift.

Shift into another gear to switch the feature off.

### **Brake Shift Interlock**

#### **About Brake Shift Interlock**

Brake shift interlock prevents you from shifting out of park (P) when you have switched the ignition on and not pressed the brake pedal.

#### **Shifting Out of Park (P)**



**WARNING:** Do not drive your vehicle until you verify that the stoplamps are working.



**WARNING:** If the parking brake is fully released, but the brake warning lamp remains illuminated, the brakes may not be working properly. Have your vehicle checked as soon as possible.

Use the brake shift interlock lever to move the selector lever out of park (P) if you cannot start the engine.

# Transmission

In the event of an electrical malfunction, it is possible that a fuse has blown or the stoplamps are not working. See **Fuse Specification Chart** (page 254).

If the vehicle battery has no charge, jump start your vehicle. See **Jump Starting the Vehicle** (page 243).

 **WARNING:** When doing this procedure, you need to take the transmission out of park (P) which means your vehicle can roll freely. To avoid unwanted vehicle movement, always fully apply the parking brake prior to doing this procedure. Use wheels chocks if appropriate.

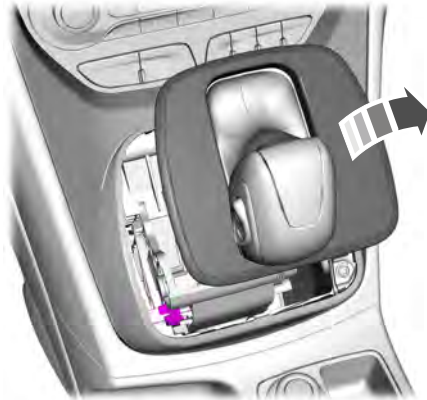

E275061

1. Using a flat-bladed screwdriver, remove the panel.



E142627

2. Locate the brake shift interlock lever.



E174827

3. Push the brake shift interlock lever toward the rear of your vehicle and hold it there.
4. Move the selector lever from park (P) to neutral (N).
5. Install the panel.
6. Press the brake pedal, start the engine and release the parking brake.

**Note:** Have your vehicle checked as soon as possible.



# Brakes

## GENERAL INFORMATION

Wet brakes result in reduced braking efficiency. Gently press the brake pedal a few times when driving from a car wash or standing water to dry the brakes.

**Note:** *Occasional brake noise is normal. If a metal-to-metal, continuous grinding or continuous squeal sound is present, the brake linings may be worn-out. Have the system checked by an authorized dealer. If your vehicle has continuous vibration or shudder in the steering wheel while braking, have it checked by an authorized dealer.*

**Note:** *Brake dust may accumulate on the wheels, even under normal driving conditions. Some dust is inevitable as the brakes wear and does not contribute to brake noise. See **Cleaning the Wheels** (page 292).*

**Note:** *Depending on applicable laws and regulations in the country for which your vehicle was originally built, the brake lamps could flash during heavy braking. Following this, the hazard lights could also flash when your vehicle comes to a stop.*

## Brake Over Accelerator

In the event that the accelerator pedal becomes stuck or entrapped, apply steady and firm pressure to the brake pedal to slow your vehicle and reduce engine power. If you experience this condition, apply the brakes and bring your vehicle to a safe stop. Move the transmission to park (P), switch the engine off and apply the parking brake. Inspect the accelerator pedal for any interference. If none are found and the condition persists, have your vehicle towed to the nearest authorized dealer.

## Brake Assist

Brake assist detects when you rapidly brake by measuring the rate at which you press the brake pedal. It provides maximum braking efficiency as long as you press the pedal, and can reduce stopping distances in critical situations

## Anti-Lock Brake System

This system helps you maintain steering control during emergency stops by keeping the brakes from locking.



If it illuminates when you are driving, this indicates a malfunction. Your vehicle continues to have normal braking without the anti-lock brake system function. Have your vehicle checked as soon as possible.

It also momentarily illuminates when you switch the ignition on to confirm the lamp is functional. If it does not illuminate when you switch the ignition on, or begins to flash at any time, have the system checked by an authorized dealer.



It illuminates when you engage the parking brake and the ignition is on.

If it illuminates when your vehicle is moving, make sure the parking brake is disengaged. If the parking brake is disengaged, this indicates low brake fluid level or a brake system fault. Have your vehicle immediately checked.

It also momentarily illuminates when you switch the ignition on to confirm the lamp is functional. If it does not illuminate when you switch the ignition on, or begins to flash at any time, have the system checked by an authorized dealer.

# Brakes

## HINTS ON DRIVING WITH ANTI-LOCK BRAKES

The anti-lock braking system does not eliminate the risks when:

- You drive too closely to the vehicle in front of you.
- Your vehicle is hydroplaning.
- You take corners too fast.
- The road surface is poor.

**Note:** *If the system activates, the brake pedal may pulse and may travel further. Maintain pressure on the brake pedal. You may also hear a noise from the system. This is normal.*

## PARKING BRAKE

 **WARNING:** Always fully apply the parking brake and make sure you shift into park (P). Switch the ignition off and remove the key whenever you leave your vehicle.

To apply the parking brake:

1. Firmly press the brake pedal.
2. Pull the parking brake lever upward to its fullest extent.

**Note:** *Do not press the release button when pulling the parking brake lever upward.*

**Note:** *If you park your vehicle on a hill and facing uphill, shift into park (P) and turn the steering wheel away from the curb.*

**Note:** *If you park your vehicle on a hill and facing downhill, shift into park (P) and turn the steering wheel toward the curb.*

To release the parking brake:

1. Firmly press the brake pedal.
2. Slightly pull the parking brake lever upward.

3. Press the release button and push the parking brake lever downward.

## HILL START ASSIST

 **WARNING:** The system does not replace the parking brake. When you leave your vehicle, always apply the parking brake. Failure to leave your vehicle securely parked may lead to a crash or injury. See **Parking Brake** (page 174).

 **WARNING:** You must remain in your vehicle once the system activates. Failure to follow this warning could result in serious personal injury or death.

 **WARNING:** During all times, you are responsible for controlling your vehicle, supervising the system and intervening, if required. Failure to take care may result in the loss of control of your vehicle, serious personal injury or death.

 **WARNING:** The system will turn off if a malfunction is apparent or if you rev the engine excessively. Failure to take care may result in the loss of control of your vehicle, serious personal injury or death.

The system makes it easier to pull away when your vehicle is on a slope without the need to use the parking brake.

When the system is active, your vehicle will remain stationary on the slope for two to three seconds after you release the brake pedal. This allows time to move your foot from the brake to the accelerator pedal. The brakes are released automatically

# Brakes

---

once the engine has developed sufficient torque to prevent your vehicle from rolling down the slope. This is an advantage when pulling away on a slope, for example from a car park ramp, traffic lights or when reversing uphill into a parking space.

The system will turn on automatically on any slope which can result in significant vehicle rollback.

## Using Hill Start Assist

1. Press the brake pedal to bring your vehicle to a complete standstill. Keep the brake pedal pressed. If equipped with a manual transmission, also press the clutch pedal.
2. If the sensors detect that your vehicle is on a slope, the system will activate automatically.
3. When you remove your foot from the brake pedal, your vehicle will remain on the slope without rolling away for approximately two to three seconds. This hold time will automatically be extended if you are in the process of driving off.
4. Drive off in the normal manner. The brakes will be released automatically.

## Switching the System On and Off

### Vehicles with Manual Transmission

You can switch this feature on or off in the information display. The system remembers the last setting when you start your vehicle.

### Vehicles with Automatic Transmission

You cannot turn the system on or off. When you switch the ignition on, the system automatically turns on.

# Traction Control

## PRINCIPLE OF OPERATION

The traction control system helps avoid drive wheel spin and loss of traction.

If your vehicle begins to slide, the system applies the brakes to individual wheels and, when needed, reduces engine power at the same time. If the wheels spin when accelerating on slippery or loose surfaces, the system reduces engine power in order to increase traction.

## USING TRACTION CONTROL



**WARNING:** The stability and traction control light illuminates steadily if the system detects a failure. Make sure you did not manually disable the traction control system using the information display controls or the switch. If the stability control and traction control light is still illuminating steadily, have the system serviced by an authorized dealer immediately. Operating your vehicle with the traction control disabled could lead to an increased risk of loss of vehicle control, vehicle rollover, personal injury and death.

The system automatically turns on each time you switch the ignition on.

If your vehicle is stuck in mud or snow, switching traction control off may be beneficial as this allows the wheels to spin.

**Note:** When you switch traction control off, stability control remains fully active.

## Switching the System Off

When you switch the system off or on, a message appears in the information display showing system status.

You can switch the system off by either using the information display controls or the switch.

## Using the Information Display Controls

You can switch this feature off or on in the information display. See **General Information** (page 92).

## Using a Switch (If Equipped)

Use the traction control switch on the instrument panel to switch the system off or on.

## System Indicator Lights and Messages



The stability and traction control light:

- Temporarily illuminates on engine start-up.
- Flashes when a driving condition activates either of the systems.
- Illuminates if a problem occurs in either of the systems.



The stability and traction control off light temporarily illuminates on engine start-up and stays on when you switch the traction control system off.

# Stability Control

## PRINCIPLE OF OPERATION



**WARNING:** Vehicle modifications involving braking system, aftermarket roof racks, suspension, steering system, tire construction and wheel and tire size may change the handling characteristics of your vehicle and may adversely affect the performance of the electronic stability control system. In addition, installing any stereo loudspeakers may interfere with and adversely affect the electronic stability control system. Install any aftermarket stereo loudspeaker as far as possible from the front center console, the tunnel, and the front seats in order to minimize the risk of interfering with the electronic stability control sensors. Reducing the effectiveness of the electronic stability control system could lead to an increased risk of loss of vehicle control, vehicle rollover, personal injury and death.



**WARNING:** Remember that even advanced technology cannot defy the laws of physics. It's always possible to lose control of a vehicle due to inappropriate driver input for the conditions. Aggressive driving on any road condition can cause you to lose control of your vehicle increasing the risk of personal injury or property damage. Activation of the electronic stability control system is an indication that at least some of the tires have exceeded their ability to grip the road; this could reduce the operator's ability to control the vehicle potentially resulting in a loss of vehicle control, vehicle rollover, personal injury and death. If your electronic stability control system activates, SLOW DOWN.

The system automatically turns on each time you switch the ignition on.

If a fault occurs in either the stability control or the traction control system, you may experience the following conditions:

- The stability and traction control light illuminates steadily.
- The stability control and traction control systems do not enhance your vehicle's ability to maintain traction of the wheels.

If a driving condition activates either the stability control or the traction control system you may experience the following conditions:

- The stability and traction control light flashes.
- Your vehicle slows down.
- Reduced engine power.
- A vibration in the brake pedal.
- The brake pedal is stiffer than usual.
- If the driving condition is severe and your foot is not on the brake, the brake pedal may move as the system applies higher brake force.

The stability control system has several features built into it to help you maintain control of your vehicle:

### Electronic Stability Control

The system enhances your vehicle's ability to prevent skids or lateral slides by applying brakes to one or more of the wheels individually and, if necessary, reducing engine power.

### Roll Stability Control

The system enhances your vehicle's ability to prevent rollovers by detecting your vehicle's roll motion and the rate at which it changes by applying the brakes to one or more wheels individually.

# Stability Control

## Traction Control

The system enhances your vehicle's ability to maintain traction of the wheels by detecting and controlling wheel spin. See **Using Traction Control** (page 176).

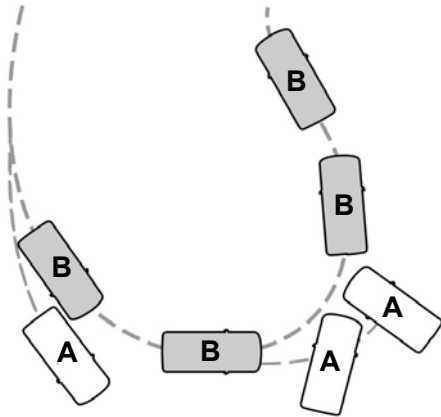

E72903

- A Vehicle without stability control skidding off its intended route.
- B Vehicle with stability control maintaining control on a slippery surface.

## USING STABILITY CONTROL

The system automatically turns on each time you switch the ignition on.

You cannot switch the stability control system off, but when you shift into reverse (R), the system deactivates.

You can switch the traction control system off or on. See **Using Traction Control** (page 176).

# Parking Aids (If Equipped)

## PRINCIPLE OF OPERATION



**WARNING:** To help avoid personal injury, please read and understand the limitations of the system as contained in this section. Sensing is only an aid for some (generally large and fixed) objects when moving on a flat surface at parking speeds. Certain objects with surfaces that absorb ultrasonic waves, surrounding vehicle's parking aid systems, traffic control systems, fluorescent lamps, inclement weather, air brakes, and external motors and fans may also affect the function of the sensing system; this may include reduced performance or a false activation.



**WARNING:** To help avoid personal injury, always use caution when in reverse (R) and when using the sensing system.



**WARNING:** This system is not designed to prevent contact with small or moving objects. The system is designed to provide a warning to assist the driver in detecting large stationary objects to avoid damaging your vehicle. The system may not detect smaller objects, particularly those close to the ground.



**WARNING:** Certain add-on devices such as large trailer hitches, bike or surfboard racks and any device that may block the normal detection zone of the system, may create false beeps.

**Note:** *Keep the sensors, located on the bumper or fascia, free from snow, ice and large accumulations of dirt. If the sensors are covered, the system's accuracy can be affected. Do not clean the sensors with sharp objects.*

**Note:** *If your vehicle sustains damage to the bumper or fascia, leaving it misaligned or bent, the sensing zone may be altered causing inaccurate measurement of obstacles or false alarms.*

**Note:** *The sensing system cannot be turned off when a MyKey is present. See **Principle of Operation** (page 56).*

**Note:** *If you attach certain add-on devices such as a trailer or bike rack, the rear sensing system may detect that add-on device and therefore provide warnings. It is suggested that you disable the rear sensing system when you attach an add-on device to your vehicle to prevent these warnings.*

The sensing system warns the driver of obstacles within a certain range of your vehicle. The system turns on automatically whenever you switch the ignition on.



You can turn the system on or off by pressing the parking aid button. If your vehicle does not have a parking aid button, the system can be switched off through the information display menu or from the pop-up message that appears once you shift the transmission into reverse (R). See **General Information** (page 92).

If a fault is present in the system, a warning message appears in the information display. See **Information Messages** (page 94).

## REAR PARKING AID



**WARNING:** The system may not detect objects with surfaces that absorb reflection. Always drive with due care and attention. Failure to take care may result in a crash.

## Parking Aids (If Equipped)



**WARNING:** The system may not detect small or moving objects, particularly those close to the ground.



**WARNING:** To help avoid personal injury, always use caution when in reverse (R) and when using the sensing system.



**WARNING:** The parking aid system can only assist you to detect objects when your vehicle is moving at parking speeds. To help avoid personal injury you must take care when using the parking aid system.

If the system malfunctions, a message appears in the information display.

**Note:** *Keep the sensors free from snow, ice and large accumulations of dirt.*

**Note:** *Do not cover up the sensors.*

**Note:** *Do not clean the sensors with sharp objects.*

**Note:** *If your vehicle sustains damage leaving the sensors misaligned, this may cause inaccurate measurements or false alerts.*

**Note:** *Some add-on accessories, for example large trailer hitches or bike or surfboard racks can cause reduced performance or false alerts.*

The sensors are active when the transmission is in reverse (R) and the vehicle speed is less than 3 mph (5 km/h). When the parking aid system sounds a tone, the audio system may reduce the set volume.

A warning tone sounds when an object approaches your vehicle. As your vehicle moves closer to an object, the rate of the tone increases. The warning tone continuously sounds when an object is 12 in (30 cm) or less from the center of the rear bumper.

**Note:** *There is a decreased coverage area at the outer corners.*



E130178

Sensor coverage area is up to 70 in (180 cm) from the rear bumper.

The system detects large objects when you shift into reverse (R) and any of the following occur:

- Your vehicle is moving backward at low speed.
- Your vehicle is stationary but an object is approaching the rear of your vehicle at low speed.
- Your vehicle is moving backward at low speed and an object is moving toward your vehicle, for example another vehicle at low speed.

If your vehicle remains stationary for two seconds the audible warning turns off. If your vehicle moves backward the tone sounds again.

**Note:** *If the detected object is 12 in (30 cm) or less from the rear bumper, the audible warning does not turn off.*

### Object Distance Indicator (If Equipped)

When you shift into reverse (R), the system provides object distance indication through the information display.



## Parking Aids (If Equipped)

- As the distance to the object decreases, the indicator blocks illuminate and move toward the vehicle icon.
- If there is no object detected, the distance indicator blocks are gray.

### Rear Parking Aid Information Messages

Message	Description
Park Aid Fault	The system has malfunctioned. Have your vehicle checked as soon as possible.
Check Park Aid	The system has malfunctioned. Have your vehicle checked as soon as possible.
Check Rear Park Aid	The system has malfunctioned. Have your vehicle checked as soon as possible.
Park Pilot Not Available Sensor Blocked See Manual	A sensor is blocked or the system has malfunctioned. Clean the bumper or remove any obstruction. If the message continues to appear, have your vehicle checked as soon as possible.
Front Park Pilot Not Available Sensor Blocked See Manual	A sensor is blocked or the system has malfunctioned. Clean the bumper or remove any obstruction. If the message continues to appear, have your vehicle checked as soon as possible.
Rear Park Pilot Not Available Sensor Blocked See Manual	A sensor is blocked or the system has malfunctioned. Clean the bumper or remove any obstruction. If the message continues to appear, have your vehicle checked as soon as possible.

### FRONT PARKING AID



**WARNING:** The system may not detect objects with surfaces that absorb reflection. Always drive with due care and attention. Failure to take care may result in a crash.



**WARNING:** The system may not detect small or moving objects, particularly those close to the ground.



**WARNING:** The parking aid system can only assist you to detect objects when your vehicle is moving at parking speeds. To help avoid personal injury you must take care when using the parking aid system.

The sensors are on the front bumper.

**Note:** Keep the sensors free from snow, ice and large accumulations of dirt.

**Note:** Do not cover up the sensors.

**Note:** Do not clean the sensors with sharp objects.

## Parking Aids (If Equipped)

**Note:** *If your vehicle sustains damage leaving the sensors misaligned, this may cause inaccurate measurements or false alerts.*

The sensors are active when the transmission is in any position other than park (P). When the parking aid system sounds a tone, the audio system may reduce the set volume.

A warning tone sounds when an object approaches your vehicle. As your vehicle moves closer to an object, the rate of the tone increases. The warning tone continuously sounds when an object is 12 in (30 cm) or less from the front bumper.

The system turns off when the vehicle speed reaches 5 mph (8 km/h).



E187330

Sensor coverage area is up to 28 in (70 cm) from the center of the bumper.

If the transmission is in reverse (R), the system detects objects when your vehicle is moving at low speed or an object is moving toward your vehicle, for example another vehicle at low speed. When you stop your vehicle, the audible warning turns off after two seconds.

If the transmission is in any forward gear, the system provides audible warnings when your vehicle is moving and an object is within the detection area. When you stop your vehicle, the audible warning turns off after two seconds and the visual warning turns off after four seconds.



Press the parking aid button to switch the system off.

If the system malfunctions, a message appears in the information display.

### Object Distance Indicator (If Equipped)

The system provides object distance indication through the information display.

- As the distance to the object decreases, the indicator blocks illuminate and move toward the vehicle icon.
- If there is no object detected, the distance indicator blocks are gray.

When you shift into reverse (R), the system provides audio warnings and visual indication when your vehicle is moving and the detected object is moving toward your vehicle. When you stop your vehicle, the audio warnings stop after two seconds. Visual indication remains on when the transmission is in reverse (R).

When you shift into any forward gear, the system provides audio warnings and visual indication when your vehicle is moving at a speed of approximately 5 mph (8 km/h) or below and the system detects an object within the detection zone. When you stop your vehicle, the audio warnings stop after two seconds and visual indication stops after four seconds.

**Note:** *If the detected object is 12 in (30 cm) or less from your vehicle, visual indication remains on.*

## Parking Aids (If Equipped)

When you shift into neutral (N), the system only provides visual indication if your vehicle is moving at a speed of approximately 5 mph (8 km/h) or below, for example, your vehicle is moving on a

slope, and the system detects an object moving toward your vehicle. When you stop your vehicle, visual indication stops after four seconds.

### Front Parking Aid Information Messages

Message	Description
Park Aid Fault	The system has malfunctioned. Have your vehicle checked as soon as possible.
Check Park Aid	The system has malfunctioned. Have your vehicle checked as soon as possible.
Check Front Park Aid	The system has malfunctioned. Have your vehicle checked as soon as possible.

## SIDE SENSING SYSTEM

The system uses the front and rear outermost parking aid sensors to detect objects that are near to the sides of your vehicle. The system displays them on a virtual map in the information display as your vehicle moves past them.

**Note:** *The system does not detect an object that is moving toward the side of your vehicle, for example another vehicle moving at low speed, if it does not pass a front or rear sensor.*

The sensors are on the front and rear bumpers.

**Note:** *Keep the sensors free from snow, ice and large accumulations of dirt.*

**Note:** *Do not cover up the sensors.*

**Note:** *Do not clean the sensors with sharp objects.*

**Note:** *If your vehicle sustains damage leaving the sensors misaligned, this may cause inaccurate measurements or false alerts.*

**Note:** *If you switch traction control off, the side sensing system also turns off.*

The system may not function if:

- You switch the ignition on, off and back on within a few seconds.
- Your vehicle remains stationary for over two minutes.
- The anti-lock brake system activates.
- The traction control system activates.

To reinitialize the system you may have to drive your vehicle approximately 10 ft (3 m).

## Parking Aids (If Equipped)



E190458

Coverage area is up to 24 in (60 cm) from the side of your vehicle.

When the system detects an object within the coverage area and the driving path of your vehicle an audible warning sounds. As the object moves closer to your vehicle, the rate of the tone increases.

### Object Distance Indicator (If Equipped)



E190459

The system provides object distance indication in the information display.

- As the distance to the object decreases, the indicator blocks illuminate and move toward the vehicle icon.
- If there is no object detected, the distance indicator blocks are gray.

When you shift into reverse (R), the system provides audible warnings and visual indication when detected objects are within 24 in (60 cm) and are inside the driving path of your vehicle. When you stop your vehicle, the audible warnings turn off after two seconds.

When you shift into any forward gear, the system provides audible warnings and visual indication when your vehicle is moving at a speed of approximately 5 mph (8 km/h) or below and the system detects an object within the detection zone. When you stop your vehicle, the audible warnings turn off after two seconds and visual indication turns off after four seconds.

When you shift into neutral (N), the system only provides visual indication if your vehicle is moving at a speed of approximately 5 mph (8 km/h) or below, for example, your vehicle is moving on a slope, and the system detects an object moving toward your vehicle. When you stop your vehicle, visual indication turns off after four seconds.

If the system is not available, the side distance indicator blocks do not display.

## ACTIVE PARK ASSIST



**WARNING:** You must remain in your vehicle when the system turns on. At all times, you are responsible for controlling your vehicle, supervising the system and intervening, if required. Failure to take care may result in the loss of control of your vehicle, serious personal injury or death.

## Parking Aids (If Equipped)



**WARNING:** The sensors may not detect objects in heavy rain or other conditions that cause interference.



**WARNING:** You are responsible for controlling your vehicle at all times. The system is designed to be an aid and does not relieve you of your responsibility to drive with due care and attention. Failure to follow this instruction could result in the loss of control of your vehicle, personal injury or death.

Active park assist is a multi-step process and may require you to shift the transmission multiple times. Follow the onscreen instructions until the parking maneuver is complete.

If you are uncomfortable with the proximity to any vehicle or object, you may choose to override the system by grabbing the steering wheel, or by taking full control of your vehicle after pressing the active park assist button.

Keep your hands, hair, clothing and any loose items clear of the steering wheel when using active park assist.

The sensors are on the front and rear bumpers.

**Note:** *Keep the sensors free from snow, ice and large accumulations of dirt.*

**Note:** *Do not cover up the sensors.*

**Note:** *Do not clean the sensors with sharp objects.*

**Note:** *The sensors may not detect objects with surfaces that absorb ultrasonic waves. The sensors may falsely detect objects due to ultrasonic interference caused by, for example motorcycle exhausts, truck air brakes or horns.*

**Note:** *If you change any tires, the system must recalibrate and may not correctly operate for a short time.*

The system may not correctly operate in any of the following conditions:

- You use a spare tire or a tire that is significantly worn more than the other tires.
- One or more tires are incorrectly inflated.
- You try to park on a tight curve.
- Something passes between the front bumper and the parking space. For example, a pedestrian or cyclist.
- The edge of the neighboring parked vehicle is high off the ground. For example, a bus, tow truck or flatbed truck.
- The weather conditions are poor. For example, during heavy rain, snow, fog, high humidity and high temperatures.

Do not use the system if:

- You have attached an add-on accessory close to the sensors on the front or rear of your vehicle. For example, a bike rack or trailer.
- You have attached an overhanging object to the roof. For example, a surfboard.
- The front bumper, rear bumper or the side sensors are damaged.
- The correct tire size is not in use on your vehicle. For example, a mini-spare tire.

### Using Active Park Assist

#### Selecting an Active Park Assist Mode



Press the button once to activate parallel parking. Press the button a second time to activate perpendicular parking. If you press the button again the system switches off.

## Parking Aids (If Equipped)

If your vehicle is parked and after you switch the ignition on, you can use the information display to toggle through the modes. Press the button to switch the system on and open the system menu in the information display.

**Note:** If your vehicle is parked, the default mode is parallel park out assist. However if you did not use active park assist to parallel park your vehicle, use the information display to select park out assist.

**Note:** You can only repeatedly press the active park assist button to toggle through the modes after moving your vehicle approximately 10 ft (3 m).

To toggle through the modes, use the buttons on the information display to select the following:

- Parallel parking.
- Perpendicular parking.
- Parallel park out assist.
- Switch the system off.

**Note:** There is no time limit for toggling through the modes.

### Parallel Parking

The system detects available parallel parking spaces and steers your vehicle into the space. You control the accelerator, gearshift and brakes. The system visually and audibly guides you into a parallel parking space.



Press the button once to search for a parking space.

**Note:** You can also switch the system on after you have already driven partially or completely past a parking space. Press the active park assist button and the system informs you if you have recently passed a suitable parking space.

When the vehicle speed is less than 22 mph (35 km/h), the system scans both sides of your vehicle for an available parking space. A message and a graphic appear in the information display to indicate the system is searching for a parking space. Use the direction indicator to be offered parking spaces on either the left-hand side or right-hand side of your vehicle.

**Note:** The system scans both sides of your vehicle and offers parking spaces one side at a time if you do not use the direction indicator.

**Note:** The system defaults to the passenger side if you do not use the direction indicator.



Drive your vehicle approximately 3 ft (1 m) and parallel to the other parked vehicles when searching for a parking space.

**Note:** If you drive your vehicle less than 2 ft (0.5 m) or greater than 5 ft (1.5 m) away from other parked vehicles, the system may not be able to detect an available parking space.

When the system detects a suitable space, a message displays and a tone sounds. Stop your vehicle and follow the onscreen instructions. If your vehicle is moving very slowly, you may have to move forward a short distance before the system is ready to park.

**Note:** You must observe that the space the system selects remains clear of obstructions at all times during the maneuver.

**Note:** The system always offers the last parking space it detects. For example, if your vehicle detects multiple spaces when you are driving, it offers the last one.

## Parking Aids (If Equipped)

**Note:** If the vehicle speed is greater than approximately 22 mph (35 km/h), the system shows a message to instruct you to reduce the vehicle speed.

### Automatically Steering into a Parallel Parking Space

When you shift into reverse (R), with your hands off the steering wheel and nothing obstructing its movement, your vehicle steers itself into the space. The system displays instructions to move your vehicle backward and forward in the space.

**Note:** If the vehicle speed exceeds approximately 6 mph (9 km/h), you interrupt the maneuver, or the system switches off, you must take full control of your vehicle.

**Note:** If the system detects an object is very close to your vehicle and it may be unsafe to continue the maneuver, it may instruct you to stop your vehicle. The system may not provide any further instruction. Steering assistance continues to operate but you must decide if it is safe to continue the maneuver.



When you believe your vehicle is correctly parked, or a solid tone sounds and an information message appears, bring your vehicle to a complete stop.

When the Active Park Assist maneuver is complete, a tone sounds and an information message appears.

**Note:** You are responsible for checking how your vehicle is parked and making any necessary corrections before leaving your vehicle.

### Brake System Intervention

The detection of objects and activation of the brake intervention system depends on certain conditions. For example vehicle load, adverse weather conditions or other conditions that may affect the system sensors.

When active park assist is controlling the steering, it may under certain conditions apply the brakes to slow or stop your vehicle.

- The brakes may be applied at a vehicle speed of approximately 5 mph (8 km/h). This feature attempts to keep the vehicle speed within the limits for assisted parking. Brake system intervention to slow your vehicle does not cancel the active park assist maneuver.
- The brakes may be applied if an obstacle is detected within the intended vehicle path. Brake system intervention may bring the vehicle to a complete stop and may decrease the effects of a crash. If the vehicle comes to a complete stop, the brakes can remain applied for a short period of time. If this feature activates, it cancels the active park assist maneuver and you must take full control of your vehicle to complete the parking maneuver.

### Deactivating Active Park Assist

You can manually deactivate the system by:

- Pressing the Active Park Assist button during an active maneuver.
- Grabbing the steering wheel during an active maneuver.
- Driving above 22 mph (35 km/h) for 30 seconds when searching for a parking space.
- Driving above 31 mph (50 km/h).

## Parking Aids (If Equipped)

- Driving above 6 mph (9 km/h) during an active maneuver.
- Switching the traction control system off.

Certain vehicle conditions may also deactivate the system, for example:

- The traction control system activates or fails.
- The anti-lock brake system activates or fails.

If the system malfunctions, a message appears and a tone sounds. Have your vehicle checked as soon as possible.

### Perpendicular Parking

The system detects available perpendicular parking spaces and steers your vehicle into the space. You control the accelerator, gearshift and brakes. The system visually and audibly guides you into a perpendicular parking space.



Press the button twice to search for a parking space.

When the vehicle speed is less than 19 mph (30 km/h), the system scans both sides of your vehicle for an available parking space. A message and a graphic appear in the information display to indicate the system is searching for a parking space. Use the direction indicator to be offered parking spaces on either the left-hand side or right-hand side of your vehicle.

**Note:** The system scans both sides of your vehicle and offers parking spaces one side at a time if you do not use the direction indicator.

**Note:** The system defaults to the passenger side if you do not use the direction indicator.



Drive your vehicle approximately 3 ft (1 m) and parallel to the other parked vehicles when searching for a parking space.

**Note:** If you drive your vehicle less than 2 ft (0.5 m) or greater than 5 ft (1.5 m) away from other parked vehicles, the system may not be able to detect an available parking space.

When the system detects a suitable space, a message displays and a tone sounds. Stop your vehicle and follow the onscreen instructions. If your vehicle is moving very slowly, you may have to move forward a short distance before the system is ready to park.

**Note:** You must observe that the space the system selects remains clear of obstructions at all times during the maneuver.

**Note:** The system always offers the last detected parking space. For example, if your vehicle detects multiple spaces when you are driving, it offers the last one.

**Note:** If the vehicle speed is greater than approximately 19 mph (30 km/h), the system shows a message to instruct you to reduce the vehicle speed.

### Automatically Steering into a Perpendicular Parking Space

When you shift into reverse (R), with your hands off the steering wheel and nothing obstructing its movement, your vehicle steers itself into the space. The system displays instructions to move your vehicle backward and forward in the space.



## Parking Aids (If Equipped)

**Note:** If the vehicle speed exceeds approximately 6 mph (9 km/h), you interrupt the maneuver, or the system switches off, you must take full control of your vehicle.

**Note:** If the system detects an object is very close to your vehicle and it may be unsafe to continue the maneuver, it may instruct you to stop your vehicle. The system may not provide any further instruction. Steering assistance continues to operate but you must decide if it is safe to continue the maneuver.

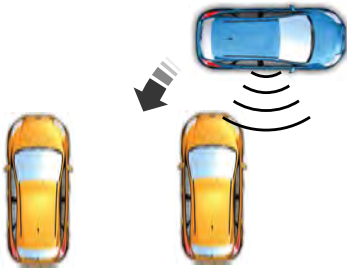

E186191

When you believe your vehicle is correctly parked, or a solid tone sounds and an information message appears, bring your vehicle to a complete stop.

When the active park assist maneuver is complete, a tone sounds and a message appears.

**Note:** You are responsible for checking how your vehicle is parked and making any necessary corrections before leaving your vehicle.

### Brake System Intervention

The detection of objects and activation of the brake intervention system depends on certain conditions. For example vehicle load, adverse weather conditions or other conditions that may affect the system sensors.

When active park assist is controlling the steering, it may under certain conditions apply the brakes to slow or stop your vehicle.

- The brakes may be applied at a vehicle speed of approximately 5 mph (8 km/h). This feature attempts to keep the vehicle speed within the limits for assisted parking. Brake system intervention to slow your vehicle does not cancel the active park assist maneuver.
- The brakes may be applied if an obstacle is detected within the intended vehicle path. Brake system intervention may bring the vehicle to a complete stop and may decrease the effects of a crash. If the vehicle comes to a complete stop, the brakes can remain applied for a short period of time. If this feature activates, it cancels the active park assist maneuver and you must take full control of your vehicle to complete the parking maneuver.

### Deactivating Active Park Assist

You can manually deactivate the system by:

- Pressing the Active Park Assist button during an active maneuver.
- Grabbing the steering wheel during an active maneuver.
- Driving above 19 mph (30 km/h) for 30 seconds when searching for a parking space.
- Driving above 31 mph (50 km/h).
- Driving above 6 mph (9 km/h) during an active maneuver.
- Switching the traction control system off.

## Parking Aids (If Equipped)

Certain vehicle conditions may also deactivate the system, for example:

- The traction control system activates or fails.
- The anti-lock brake system activates or fails.

If the system malfunctions, a message appears and a tone sounds. Have your vehicle checked as soon as possible.

### Parallel Park Out Assist

The system steers your vehicle out of a parallel parking space. You control the accelerator, gearshift and brakes. The system visually and audibly guides you out of a parallel parking space.

**Note:** This system is not intended to assist when exiting a perpendicular parking space.



Press the button once when your vehicle is stationary in a parallel parking space.

**Note:** If you did not use active park assist to parallel park your vehicle, pressing the button once selects parallel park. You must use the information display to select park out assist.

The system displays a message instructing you to switch a direction indicator on. Use the direction indicator to select which side of your vehicle you want to exit the parking space. The system displays instructions to move your vehicle backward and forward in the space.

**Note:** If the system detects an object is very close to your vehicle and it may be unsafe to continue the maneuver, it may instruct you to stop your vehicle. The system may not provide any further instruction. Steering assistance continues to operate but you must decide if it is safe to continue the maneuver.



After the system directs your vehicle to a position where you can exit the parking space in a forward movement, a message appears instructing you to take full control of your vehicle. Generally hand-over is when your vehicle is still inside the parking space.

**Note:** Parallel Park Out Assist may not be available when the clearance to the front or the rear of your vehicle is too small.

**Note:** If the vehicle speed exceeds approximately 6 mph (9 km/h), you interrupt the maneuver, or the system switches off, you must take full control of your vehicle.

**Note:** You are responsible for controlling your vehicle and making sure the path is clear prior to pulling into traffic.

### Brake System Intervention

The detection of objects and activation of the brake intervention system depends on certain conditions. For example vehicle load, adverse weather conditions or other conditions that may affect the system sensors.

When active park assist is controlling the steering, it may under certain conditions apply the brakes to slow or stop your vehicle.

- The brakes may be applied if an obstacle is detected within the intended vehicle path. Brake system intervention may bring the vehicle to a complete stop and may decrease the effects of a crash. If the vehicle comes to a complete stop, the brakes can

## Parking Aids (If Equipped)

remain applied for a short period of time. If this feature activates, it cancels the active park assist maneuver and

you must take full control of your vehicle to complete the parking maneuver.

### Troubleshooting

Symptom	Possible Cause
The system does not search for a parking space.	You may have switched the traction control off.
	The transmission is in reverse (R). Your vehicle must be moving forward to be able to detect a parking space.
The system does not offer a parking space.	The sensors may be blocked. For example, snow, ice or dirt buildup. Blocked sensors can affect how the system functions.
	There is not enough room in the parking space for your vehicle to safely park.
	There is not enough space for the parking maneuver on the opposite side of the parking space.
	The parking space is more than 5 ft (1.5 m) or less than 2 ft (0.5 m) away.
	The vehicle speed is greater than 22 mph (35 km/h) for parallel parking or greater than 19 mph (30 km/h) for perpendicular parking.
	You recently disconnected or replaced the battery. After you reconnect the battery you must drive your vehicle on a straight road for a short period of time.
The system does not correctly position your vehicle in a parking space.	Your vehicle is rolling in the opposite direction of the current transmission position. For example, rolling forward when in reverse (R).
	An irregular curb along the parking space prevents the system from correctly aligning your vehicle.
	Vehicles or objects bordering the space may not be correctly parked.
	Your vehicle stopped too far past the parking space.
	The tires may not be correctly installed or maintained. For example, not inflated correctly, improper size, or of different sizes.
	A repair or alteration changes the detection capabilities.

## Parking Aids (If Equipped)

Symptom	Possible Cause
	A parked vehicle has a high attachment. For example, a salt sprayer, snowplow or moving truck bed.
	The parking space length or position of parked objects changes after your vehicle passes the space.
	The temperature around your vehicle quickly changes. For example, driving from a heated garage into the cold, or after leaving a car wash.

**Note:** *The operation of the camera may vary depending on the ambient temperature, vehicle and road conditions.*

### REAR VIEW CAMERA

 **WARNING:** The rear view camera system is a reverse aid supplement device that still requires the driver to use it in conjunction with the interior and exterior mirrors for maximum coverage.

 **WARNING:** The camera may not detect objects that are very close to your vehicle.

 **WARNING:** Back up as slow as possible since higher speeds might limit your reaction time to stop the vehicle.



E165580



E165579

The camera is on the rear cargo door or liftgate.

## Parking Aids (If Equipped)

### Switching the Rear View Camera On

Switch the ignition on.

Move the transmission selector lever to reverse (R).

The camera may not operate correctly in the following conditions:

- Dark areas.
- Intense light areas.
- If there is a sudden change to the ambient temperature.
- If the camera is wet.
- If the camera is obstructed.

### Using the Display



**WARNING:** Objects in the display are closer than they appear.



**WARNING:** Objects above the camera may not be visible. Check the area behind your vehicle when necessary.

Distance markers are only a guide and are calculated for unloaded vehicles on an even road surface.

The lines show a projected vehicle path and the approximate distance from the rear bumper to an object.

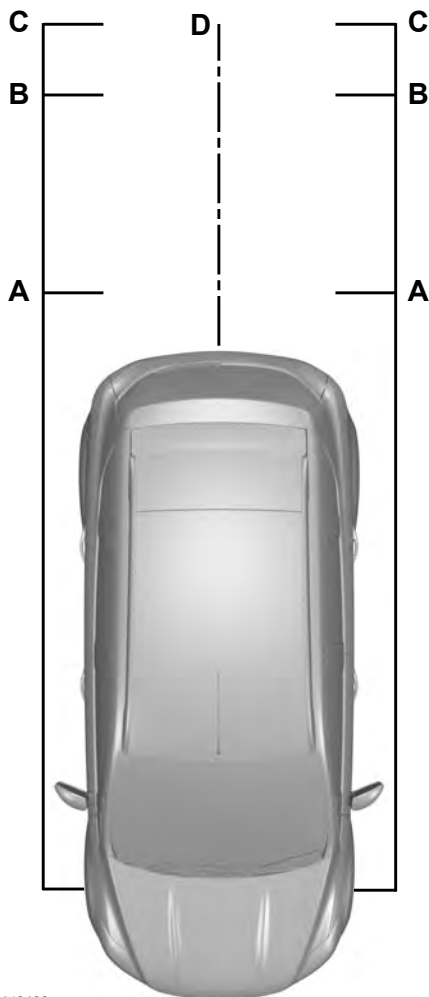

E142132

- A Red - Zone
- B Amber - Zone

## Parking Aids (If Equipped)

---

- C Green - Zone
- D Black - center line of the projected vehicle path

**Note:** *When reversing with a trailer the camera will show the direction of your vehicle and not the direction of the trailer.*

**Note:** *When reversing with a trailer the screen does not display the lines.*

### Switching the Rear View Camera Off

The image does not display when you move the gearshift lever into Park (P).

### Vehicles With Rear View Camera Delay

To turn this feature on See **Settings** (page 386).

The display will automatically switch off after disengaging reverse (R) gear.

The system will automatically switch off when your vehicle speed is above 5.0 mph (8 km/h).

**Note:** *Depending upon which type of multimedia display you have, the rear view camera delay is always on, it cannot be switched off.*

### Vehicles With Parking Aid

The display will show a colored distance bar. This indicates the approximate distance from the rear bumper to an object.

These are color coded as follows:

- Red - Zone
- Amber - Zone
- Green - Zone

# Cruise Control

## PRINCIPLE OF OPERATION

Cruise control lets you maintain a set speed without keeping your foot on the accelerator pedal. You can use cruise control when your vehicle speed is greater than 20 mph (30 km/h).

## USING CRUISE CONTROL



**WARNING:** Do not use cruise control on winding roads, in heavy traffic or when the road surface is slippery. This could result in loss of vehicle control, serious injury or death.



**WARNING:** When you are going downhill, your vehicle speed could increase above the set speed. The system does not apply the brakes.



E142437

The cruise controls are on the steering wheel.

**Note:** Cruise control disengages if your vehicle speed decreases more than 10 mph (16 km/h) below the set speed when driving uphill.

## Switching Cruise Control On

Press and release **ON**.



The indicator appears in the information display.

## Setting the Cruise Speed

1. Drive to desired speed.
2. Press and release **SET+**.
3. Take your foot off the accelerator pedal.

## Changing the Set Speed

- Press and release **SET+** or **SET-**. When you select km/h as the display measurement in the information display the set speed changes in approximately 2 km/h increments. When you select mph as the display measurement in the information display the set speed changes in approximately 1 mph increments.
- Press the accelerator or brake pedal until you reach the desired speed. Press and release **SET+**.
- Press and hold **SET+** or **SET-**. Release the control when you reach the desired speed.

## Canceling the Set Speed

Pull and release **CAN** or tap the brake pedal. The set speed does not erase.

## Resuming the Set Speed

Pull and release **RES**.

## Switching Cruise Control Off

Press and release **OFF** when the system is in standby mode or switch the ignition off.

**Note:** You erase the set speed when you switch the system off.

# Cruise Control

## USING ADAPTIVE CRUISE CONTROL



**WARNING:** Always pay close attention to changing road conditions when using adaptive cruise control. The system does not replace attentive driving. Failing to pay attention to the road may result in a crash, serious injury or death.



**WARNING:** You are responsible for controlling your vehicle at all times. The system is designed to be an aid and does not relieve you of your responsibility to drive with due care and attention. Failure to follow this instruction could result in the loss of control of your vehicle, personal injury or death.



**WARNING:** Adaptive cruise control may not detect stationary or slow moving vehicles below 6 mph (10 km/h).



**WARNING:** Do not use adaptive cruise control on winding roads, in heavy traffic or when the road surface is slippery. This could result in loss of vehicle control, serious injury or death.



**WARNING:** Do not use the system when towing a trailer that has aftermarket electronic trailer brake controls. Failure to follow this instruction could result in the loss of control of your vehicle, personal injury or death.



**WARNING:** Adaptive cruise control is not a crash warning or avoidance system.



**WARNING:** Adaptive cruise control does not detect pedestrians or objects in the road.



**WARNING:** Adaptive cruise control does not detect oncoming vehicles in the same lane.



**WARNING:** Do not use the system in poor visibility, for example fog, heavy rain, spray or snow.



**WARNING:** Do not use tire sizes other than those recommended because this can affect the normal operation of the system. Failure to do so may result in a loss of vehicle control, which could result in serious injury.

The system helps you to maintain a gap from the vehicle in front of you. The system adjusts your vehicle speed to maintain the set gap between you and the vehicle in front of you in the same lane. The system applies the brakes to slow your vehicle to maintain a safe gap distance from the vehicle in front.

The system uses a radar sensor which projects a beam directly in front of your vehicle.

The adaptive cruise controls are on the steering wheel.

## Switching Adaptive Cruise Control On



Press and release the switch.

The information display shows the grey indicator light. The system is now in standby.



# Cruise Control



E260516

The indicator, current gap setting and set speed appear in the information display.

## Setting the Adaptive Cruise Speed

Drive to the required speed.

**SET+** Press the toggle button upward to set the current speed.

Take your foot off the accelerator pedal.

A green indicator light, the current gap setting and the set speed appear in the information display.



E249552

A vehicle image displays if there is a vehicle detected in front of you.

**Note:** When adaptive cruise control is active, the speedometer may vary slightly from the set speed displayed in the information display.

## Following a Vehicle



**WARNING:** When following a vehicle, your vehicle does not decelerate automatically to a stop, nor does your vehicle always decelerate quickly enough to avoid a crash without driver intervention. Always apply the brakes when necessary. Failing to do so may result in a crash, serious injury or death.



**WARNING:** Adaptive cruise control only warns of vehicles detected by the radar sensor. In some cases there may be no warning or a delayed warning. You should always apply the brakes when necessary. Failure to do so may result in a crash, serious injury or death.

When a vehicle ahead of you enters the same lane or a slower vehicle is ahead in the same lane, the vehicle speed adjusts to maintain a preset gap distance.

**Note:** The brakes may emit noise when applied by the system.

The system may provide slight temporary acceleration when you use your driver side direction indicator while following a vehicle to aid passing the vehicle.

Your vehicle maintains a consistent gap from the vehicle ahead until:

- The vehicle in front of you accelerates to a speed above the set speed.
- The vehicle in front of you moves out of your lane or out of view.
- The vehicle speed falls below 12 mph (20 km/h).
- A new gap distance is set.

The system applies the brakes to slow the vehicle to maintain a safe distance from the vehicle in front. The system applies only limited maximum braking. Press the brake pedal to override the system.

# Cruise Control

If the system determines that its maximum braking level is not sufficient, an audible warning sounds and a message appears in the information display when the system continues to brake. You must take immediate action.

**Note:** It is your responsibility to select a gap appropriate to the driving conditions.

## Setting the Gap Distance

You can decrease or increase the distance between your vehicle and the vehicle in front by pressing the gap control.



Press and release to decrease the gap distance.



Press and release to increase the gap distance.



The selected gap appears in the information display as shown by the bars in the image. You can select four gap settings.

## Adaptive cruise control, distance between vehicle settings

Graphic display, bars indicated between vehicles	Distance gap	Dynamic behavior
1	Closest.	Sport.
2	Close.	Normal.
3	Medium.	Normal.
4	Furthest.	Comfort.

When you switch the ignition on, the system automatically selects the last chosen gap setting.

When you override the system, the green indicator light illuminates and the vehicle graphic does not appear in the information display.

## Overriding the System



**WARNING:** If you override the system by pressing the accelerator pedal, it does not automatically apply the brakes to maintain a gap from any vehicle ahead.

Use the accelerator pedal normally to intentionally exceed the set speed limit.

## Changing the Set Speed



Press the toggle button upward to increase the set speed.



Press the toggle button downward to decrease the set speed.

The set speed changes in small increments.

# Cruise Control

**Note:** Press and hold the toggle button upward or downward to change the set speed in larger increments.

The system may apply the brakes to slow the vehicle to the new set speed. The set speed displays continuously in the information display when the system is active.

## Canceling the Set Speed

**CAN**

Press and release the switch or tap the brake pedal.

The last set speed and gap setting displays in grey but does not erase.

**Note:** If you press the clutch pedal for an extended period, this action also cancels the set speed.

## Resuming the Set Speed

**RES**

Press and release the switch.

Your vehicle speed returns to the previously set speed and gap setting. The set speed shows continuously in the information display while the system is active.

**Note:** Only use resume if you are aware of the set speed and intend to return to it.

## Automatic Cancellation

The system is not functional at vehicle speeds below 12 mph (20 km/h). An audible alarm sounds and the automatic braking releases if the vehicle drops below this speed.

Automatic cancellation can also occur when:

- The tires lose traction.
- The engine speed is too low.
- You apply the parking brake.

**Note:** If the engine speed drops too low, the information display advises you to shift to a lower gear.

## Hilly Condition Usage

**Note:** An audible alarm sounds and the system shuts down if it applies brakes for an extended period of time. This allows the brakes to cool. The system functions normally again when the brakes have cooled.

You should select a lower gear when the system is active in situations such as prolonged downhill driving on steep grades, for example in mountainous areas. The system needs additional engine braking in these situations to reduce the load on the vehicle's regular brake system to prevent it from overheating.

## Switching Adaptive Cruise Control Off



Press and release the switch.

**Note:** You erase the set speed when you switch the system off.

## Detection Issues



**WARNING:** On rare occasions, detection issues can occur due to the road infrastructures, for example bridges, tunnels and safety barriers. In these cases, the system may brake late or unexpectedly. At all times, you are responsible for controlling your vehicle, supervising the system and intervening, if required.



**WARNING:** If the system malfunctions, have your vehicle checked as soon as possible.

# Cruise Control

The radar has a limited field of view. It does not detect all vehicles in all situations and could detect vehicles later than you expect. The lead vehicle image does not display if the system does not detect a vehicle in front of you.

**A**

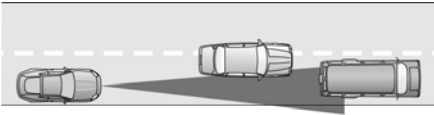

**B**

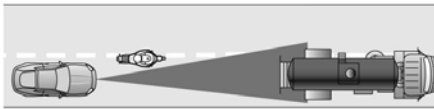

**C**

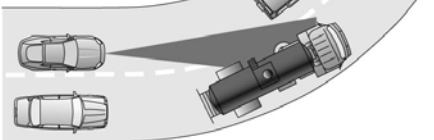

E71621

Detection issues can occur:

- A With vehicles that edge into your lane that can only be detected once they have moved fully into your lane.
- B Motorcyclists may be detected late, or not at all.
- C With vehicles in front of you when going into and coming out of a bend. The detection beam does not follow sharp curves in the road.

In these cases the system may brake late or unexpectedly. You should stay alert and intervene if necessary.

If something hits the front of your vehicle or damage occurs, the radar-sensing zone may change. This could cause missed or false vehicle detections. Contact an authorized dealer as soon as possible.

## System Not Available

The system may not turn on if there is:

- A blocked sensor.
- High brake temperature.
- A failure in the system or a related system.

## Blocked Sensor



E244279

A message displays if something obstructs the radar signals from the sensor. The sensor is behind the grille. The system cannot detect a vehicle ahead and does not function when something blocks the sensor.

**Note:** *You cannot see the sensor, it is behind a fascia panel.*

Keep the front of your vehicle free of dirt, metal badges or objects. Vehicle front protectors and aftermarket lights may also block the sensor.

# Cruise Control

Cause	Action
The surface of the radar in the grille is dirty or obstructed in some way.	Clean the radiator grille in front of the radar or remove any obstruction.
The surface of the radar is clean but the message remains in the display.	Wait a short period of time. It may take several minutes for the radar to detect that it is free from obstruction.
Heavy rain or snow interfere with the radar signals.	Do not use the system in these conditions because it may not detect any vehicles ahead.
Swirling water, snow or ice on the surface of the road interfere with the radar signals.	Do not use the system in these conditions because it may not detect any vehicles ahead.
You are in a desert or remote area with no other vehicles and no roadside objects.	Wait a short period of time or switch to normal cruise control.

It is possible to get a blockage warning and not be blocked. A false blocked condition self clears or clears after a key cycle.

Due to the nature of radar technology, you may get a blocked sensor warning when no obstruction blocks your sensor. This can happen, for example, when driving in sparse rural or desert environments. A false blocked condition either self clears or clears after a key cycle.



The gap setting does not display and the system does not respond to lead vehicles. Automatic braking remains active to maintain set speed.

## Switching to Normal Cruise Control



**WARNING:** Normal cruise control will not brake when your vehicle is approaching slower vehicles. Always be aware of which mode you have selected and apply the brakes when necessary.

You can change from adaptive cruise control to cruise control using the information display.

# Driving Aids

## SPEED LIMITER

### Principle of Operation



**WARNING:** When you are going downhill, your vehicle speed may increase above the set speed. The system will not apply the brakes but a warning displays. Failure to follow this warning could result in serious personal injury or death.

The system allows you to set a speed, to which your vehicle then becomes limited. The set speed will become the effective maximum speed of your vehicle, but with the option to temporarily exceed this limit if required.

### Using the System

**The system is operated by adjustment controls mounted on the steering wheel.**



E133198

- A Set speed increase
- B On and off
- C Set speed decrease
- D Cancel and resume

**Note:** The set speed limit can be intentionally exceeded for a short period of time if required, for example when overtaking.

### Switching the System On and Off

Press switch B. The information display will prompt you to set a speed.

### Setting the Speed Limit

Press switch A or C with the limiter in standby mode to set the limiter to the current vehicle speed.

Press switch A or C to select your desired speed limit. The speed is displayed in the information display and stored as the set speed.

Pull switch D to cancel the limiter and place it in standby mode. The information display will confirm this has been turned off by showing the set speed crossed out.

Pull switch D again to resume the limiter. The information display will confirm this has been turned on by showing the set speed again.

### Intentionally Exceeding the Set Speed Limit

Depress the accelerator fully to temporarily switch the system off. The system will turn on once your vehicle speed drops below the set speed.

### System Warnings

If you accidentally exceed the set speed, the set speed indicator flashes in the information display and a warning tone sounds.

If you intentionally exceed the set speed, the set speed indicator flashes in the information display.

# Driving Aids

## DRIVER ALERT



**WARNING:** The system is designed to aid the driver. It is not intended to replace your attention and judgment. You are still responsible to drive with due care and attention.



**WARNING:** At all times, you are responsible for controlling your vehicle, supervising the system and intervening, if required. Failure to take care may result in the loss of control of your vehicle, serious personal injury or death.



**WARNING:** The system may not operate properly if the sensor is blocked. Keep the windshield free from obstruction.



**WARNING:** Take regular rest breaks if you feel tired. Do not wait for the system to warn you.



**WARNING:** Certain driving styles may result in the system warning you even if you are not feeling tired.



**WARNING:** In cold and severe weather conditions the system may not function. Rain, snow and spray can all limit sensor performance.



**WARNING:** The system will not operate if the sensor cannot track the road lane markings.



**WARNING:** If damage occurs in the immediate area surrounding the sensor, have your vehicle checked as soon as possible.



**WARNING:** The system may not correctly operate if your vehicle is fitted with a suspension kit not approved by us.

The system is designed to alert you if it calculates that you are becoming drowsy or if your driving deteriorates.

The system calculates your alertness level based upon your driving behavior in relation to the lane markings and other factors when the vehicle speed is greater than approximately 40 mph (65 km/h).

### Driver Alert System Warnings

The warning system has two stages:

1. A temporary warning is issued to advise you to take a rest. This message only appears for a short time.
2. If you do not rest and the system continues to detect that your driving deteriorates, it issues a further warning. This remains in the information display until you cancel it.

**Note:** *The system does not warn you if the vehicle speed falls below approximately 40 mph (65 km/h).*

# Driving Aids

## Driver Alert System Display

To view the driver alert system status, use the information display controls on the steering wheel to select the following:

Menu Item	Action
Settings	Press the menu button.
Information	Press the <b>OK</b> button.
Driver Alert	Press the <b>OK</b> button.

Your calculated alertness level is shown by six steps as a colored bar. The bar travels from right to left as your calculated alertness level decreases.

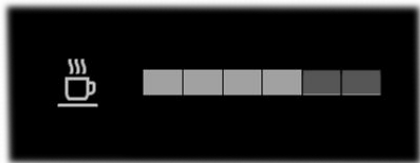

E249476

Your calculated alertness level is good.



E249477

Your calculated alertness level is low. You should stop your vehicle and take a rest as soon as it is safe to do so.

Your calculated alertness level shows in gray if:

- The sensor cannot track the road lane markings.
- The vehicle speed is less than approximately 40 mph (65 km/h).

## Switching Driver Alert On or Off

To switch driver alert on or off, use the information display controls on the steering wheel to select the following:

Menu Item	Action
Driver Assist.	Press the menu button.
Driver Alert	Press the <b>OK</b> button.

**Note:** The system remains on or off depending on how it was last set.



# Driving Aids

## Resetting Driver Alert

You can reset the system by:

- Switching the ignition off and on when your vehicle is stationary.
- Opening and closing the driver door when your vehicle is stationary.

## Driver Alert System Messages

Message	Action
Driver Alert Warning Rest Suggested	Displays when we recommend that you take a break due to low alertness levels.
Driver Alert Warning Rest Now	Displays when you must take a break due to low alertness levels.

## LANE KEEPING SYSTEM

 **WARNING:** The system is designed to aid the driver. It is not intended to replace your attention and judgment. You are still responsible to drive with due care and attention.

 **WARNING:** At all times, you are responsible for controlling your vehicle, supervising the system and intervening, if required. Failure to take care may result in the loss of control of your vehicle, serious personal injury or death.

 **WARNING:** The system may not function if the sensor is blocked.

 **WARNING:** The sensor may incorrectly track lane markings as other structures or objects. This can result in a false or missed warning.

 **WARNING:** In cold and severe weather conditions the system may not function. Rain, snow and spray can all limit sensor performance.

 **WARNING:** Large contrasts in outside lighting can limit sensor performance.

 **WARNING:** The system will not operate if the sensor cannot track the road lane markings.

 **WARNING:** If damage occurs in the immediate area surrounding the sensor, have your vehicle checked as soon as possible.

 **WARNING:** The system may not correctly operate if your vehicle is fitted with a suspension kit not approved by us.

The system is designed to alert you by providing a temporary steering torque input or steering wheel vibration when it detects an unintended lane departure. The system detects and tracks the road lane markings using a camera mounted behind the interior mirror. The system only operates when the vehicle speed is greater than approximately 40 mph (65 km/h). You can view the system status in the instrument cluster.

**Note:** *The system works when the camera can detect at least one lane marking.*

# Driving Aids

The system may not correctly operate in any of the following conditions:

- The system does not detect at least one lane marking.
- You switch the direction indicator on.
- You apply direct steering, accelerate fast or brake hard.
- The vehicle speed is less than 40 mph (65 km/h).
- The anti-lock brake, stability control or traction control system activates.
- Narrow lane width.

The system may not correct lane positioning in any of the following conditions:

- High winds.
- Uneven road surfaces.
- Heavy or uneven loads.
- Incorrect tire pressure.

## Intensity Setting

**To adjust the steering wheel vibration intensity setting, use the information display controls on the steering wheel to select the following:**

Menu Item	Action
Driver Assist.	Press the menu button.
Lane Keeping System	Press the <b>OK</b> button.
Intensity	Press the <b>OK</b> button. Press the toggle button upward or downward to choose your required setting. Press the <b>OK</b> button.

**Note:** This setting does not affect the aid mode.

## Switching Lane Keeping System On or Off



Press the button on the steering wheel stalk.

## Lane Keeping System Settings

The system has different settings that you can view or adjust using the information display.

**Note:** The system remembers the last setting when you start your vehicle. If the system detects a MyKey, the mode is set to alert.

## Alert Mode

Provides a steering wheel vibration when the system detects an unintended lane departure.

# Driving Aids

## Sensitivity Setting

To adjust how quickly the system alerts you, use the information display controls on the steering wheel to select the following:

Menu Item	Action
Driver Assist.	Press the menu button.
Lane Keeping System	Press the <b>OK</b> button.
Sensitivity	Press the <b>OK</b> button. Press the toggle button upward or downward to choose your required setting. Press the <b>OK</b> button.

## Aid Mode

Provides a temporary steering torque input toward the lane center when the system detects an unintended lane departure.

**Note:** When aid mode is on and the system does not detect any steering activity for a short period of time, for example lightly holding the steering wheel, the system alerts you to put your hands on the steering wheel.

## Alert and Aid Mode

Provides a temporary steering torque input toward the lane center when the system detects an unintended lane departure. If your vehicle continues drifting out of the lane, the steering wheel vibrates.

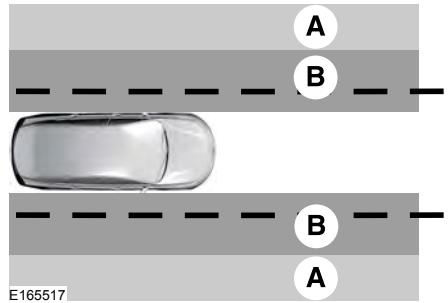

A Alert mode.

B Aid mode.

**Note:** The diagram illustrates general zone coverage. It does not provide exact zone parameters.

To change between the lane keeping system modes, use the information display controls on the steering wheel to select the following:

Menu Item	Action
Driver Assist.	Press the menu button.
Lane Keeping System	Press the <b>OK</b> button.
Mode	Press the <b>OK</b> button. Press the toggle button upward or downward to choose your required setting. Press the <b>OK</b> button.

# Driving Aids

## Lane Keeping System Display

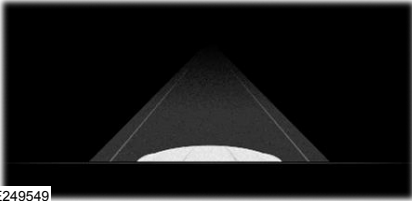

E249549

When the system is off, the system indicator or the lane markings do not display.

### Alert Mode



E249550

When you switch the system on, an indicator appears in the instrument cluster and a graphic showing the lane markings displays.

When the system is on, the color of the lane markings and the system indicator change to indicate the system status.

	System Status
Gray.	Unavailable.
Green.	Available.
White.	
Red.	Warning provided.
An indicator flashes.	

### Aid Mode



E249551

If you switch aid mode on, arrows also display with the lane markings.

## Lane Keeping System Warning Lamps and Indicators

### Lane Keeping Alert Indicator



It illuminates when you switch the system on.

### Lane Keeping Aid Warning Lamp



It illuminates when the system activates.

# Driving Aids

## Lane Keeping System Messages

Message	Action
Lane Keeping Sys. Malfunction Service Required	The system has detected a fault that requires service. Have your vehicle checked as soon as possible.

## BLIND SPOT INFORMATION SYSTEM



**WARNING:** Do not use the blind spot information system as a replacement for using the interior and exterior mirrors or looking over your shoulder before changing lanes. The blind spot information system is not a replacement for careful driving.



**WARNING:** The system may not operate properly during severe weather conditions, for example snow, ice, heavy rain and spray. Always drive with due care and attention. Failure to take care may result in a crash.



E255695

The system is designed to detect vehicles that may have entered the blind spot zone. The detection area is on both sides of your vehicle, extending rearward from the exterior mirrors to approximately 13 ft (4 m) beyond the rear bumper. The detection area extends to approximately 59 ft (18 m) beyond the rear bumper when the vehicle speed is greater than 30 mph (48 km/h) to alert you of faster approaching vehicles.

**Note:** *The system does not prevent contact with other vehicles. It is not designed to detect parked vehicles, pedestrians, animals or other infrastructures.*

### Using the Blind Spot Information System

#### Vehicles with Automatic Transmission

The system turns on when all of the following occur:

- You start your vehicle.
- You shift into drive (D).
- The vehicle speed is greater than 6 mph (10 km/h).

**Note:** *The system does not operate in park (P) or reverse (R).*

#### Vehicles with Manual Transmission

The system turns on when all of the following occur:

- You start your vehicle.
- The vehicle speed is greater than 6 mph (10 km/h).

# Driving Aids

**Note:** The system does not operate in reverse (R).

## System Lights and Messages



E142442

When the system detects a vehicle, an alert indicator illuminates in the exterior mirror on the side the approaching vehicle is coming from. If you turn the direction indicator on for that side of your vehicle, the alert indicator flashes.

**Note:** The system may not alert you if a vehicle quickly passes through the detection zone.

## Blocked Sensors

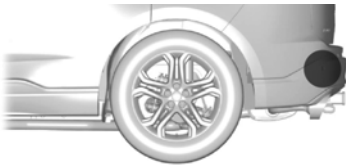

E205199

The sensors are behind the rear bumper on both sides of your vehicle.

**Note:** Keep the sensors free from snow, ice and large accumulations of dirt.

**Note:** Do not cover the sensors with bumper stickers, repair compound or other objects.

**Note:** Blocked sensors could affect system performance.

If the sensors become blocked, a message may appear in the information display. See **Information Messages** (page 94). The alert indicators remain illuminated but the system does not alert you.

## System Errors

If the system detects a fault, a warning lamp illuminates and a message displays. See **Information Messages** (page 94).

## Switching the System On and Off

You can switch the system off using the information display. See **General Information** (page 92). When you switch the system off, a warning lamp illuminates and a message displays. When you switch the system on or off, the alert indicators flash twice.

**Note:** The system remembers the last setting when you start your vehicle.

**Note:** The system may not correctly operate when towing a trailer. For vehicles with a trailer tow module and tow bar approved by us, the system turns off when you attach a trailer. For vehicles with an aftermarket trailer tow module or tow bar, we recommend that you switch the system off when you attach a trailer.

To permanently switch the system off, contact an authorized dealer.

# Driving Aids

## CROSS TRAFFIC ALERT



**WARNING:** Do not use the cross traffic alert system as a replacement for using the interior and exterior mirrors or looking over your shoulder before reversing out of a parking space. The cross traffic alert system is not a replacement for careful driving.



**WARNING:** The system may not operate properly during severe weather conditions, for example snow, ice, heavy rain and spray. Always drive with due care and attention. Failure to take care may result in a crash.

Cross Traffic Alert is designed to warn you of vehicles approaching from the sides when the transmission is in reverse (R).

### Using the System

Cross Traffic Alert turns on when you start the engine and you shift into reverse (R). Once shifted out of reverse (R), Cross Traffic Alert turns off.

**Note:** *Cross Traffic Alert only functions while your transmission is in reverse (R).*

Cross Traffic Alert is designed to detect vehicles that approach with a speed up to 37 mph (60 km/h). Coverage decreases when the sensors are partially, mostly or fully obstructed. Reversing slowly helps increase the coverage area and effectiveness.

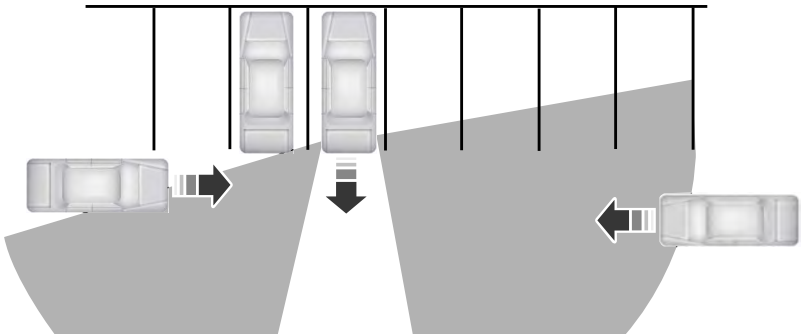

E142440

In this first example, the left sensor is only partially obstructed; zone coverage to the right is nearly maximized.

# Driving Aids

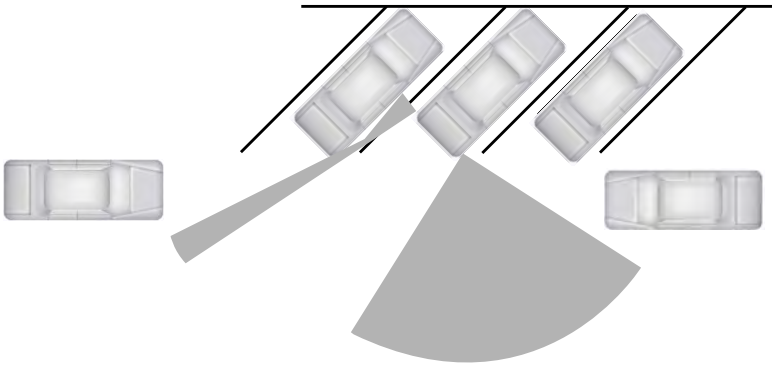

E142441

Zone coverage also decreases when parking at shallow angles. Here, the left sensor is mostly obstructed; zone coverage on that side is severely limited.

## System Lights, Messages and Audible Alerts

The Cross Traffic Alert illuminates an amber alert indicator in the outside mirror on the side of your vehicle the approaching vehicle is coming from. Cross Traffic Alert also sounds an audible alert and a message appears in the information display indicating a vehicle is coming from the right or left. Cross Traffic Alert works with the reverse sensing system that sounds its own series of tones. See **Rear Parking Aid** (page 179).



E142442

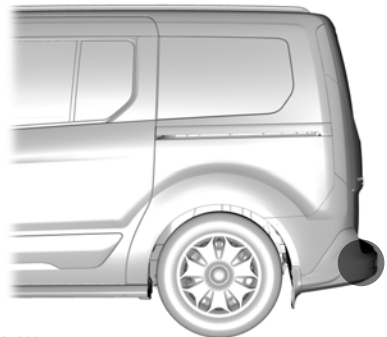

E225619



# Driving Aids

The system uses radar sensors that are located behind the bumper fascia on each side of your vehicle. Do not allow mud, snow or bumper stickers to obstruct these areas, this can cause degraded system performance. See **Blind Spot Information System** (page 209). If the Blind Spot Information System is blocked, Cross Traffic Alert is also blocked. A corresponding message appears in the information display as soon as you shift the transmission into reverse (R).

## System Limitations

Cross Traffic Alert has its limitations; situations such as severe weather conditions or debris build-up on the sensor area may limit vehicle detection.

The following are other situations that may limit the Cross Traffic Alert performance:

- Adjacently parked vehicles or objects obstructing the sensors.
- Approaching vehicles passing at speeds greater than 37 mph (60 km/h).
- Driving in reverse faster than 7 mph (12 km/h).
- Backing out of an angled parking spot.

## False Alerts

**Note:** *If your vehicle has a tow bar with a factory equipped trailer tow module and it is towing a trailer, the sensors will automatically turn the Cross Traffic Alert off. If your vehicle has a tow bar but no factory equipped trailer tow module, it is recommended to turn the Cross Traffic Alert off manually. Operating Cross Traffic Alert with a trailer attached will cause poor Cross Traffic Alert performance.*

There may be certain instances when there is a false alert by the Cross Traffic Alert system that illuminates the alert indicator with no vehicle in the coverage zone. Some amount of false alerts are normal; they are temporary and self-correct.

## System Errors

If Cross Traffic Alert senses a problem with the left or right sensor a message will appear in the information display. See **Information Messages** (page 94).

## Switching the System Off and On

You can temporarily switch Cross Traffic Alert off in the information display. See **General Information** (page 92). When you switch Cross Traffic Alert off, you will not receive alerts and the information display will display a system off message.

**Note:** *The Cross Traffic Alert switches on whenever the ignition is switched on and ready to provide appropriate alerts when the transmission is in reverse (R). Cross Traffic Alert will not remember the last selected on or off setting.*

You can also have Cross Traffic Alert switched off permanently at an authorized dealer. Once switched off permanently, the system can only be switched back on at an authorized dealer.

## ECO MODE

### Principle of Operation

The system is designed to monitor certain driving characteristics to help you drive more efficiently. See **Economical Driving** (page 238).

**Note:** *The efficiency levels do not result in a defined fuel consumption figure. See **Fuel Consumption** (page 157).*

# Driving Aids

**Note:** *The system only indicates the efficiency level for the current trip. The system resets each time you switch the ignition on.*

## Eco Mode System Display

You can view the instantaneous efficiency level or the trip summary in the information display.

**To view the instantaneous efficiency level, use the information display controls on the steering wheel to select the following:**

Menu Item	Action
MyView	Press the menu button.
Eco Coach	Press the <b>OK</b> button.

## Trip Summary

The calculated trip summary is shown as three colored bars. The bars travel from left to right as the calculated efficiency levels increase. The bars indicate the average efficiency level for acceleration, deceleration and speed during the total distance traveled by your vehicle for the current trip.

**To view the trip summary, use the information display controls on the steering wheel to select the following:**

Menu Item	Action
MyView	Press the menu button.
Eco Coach	Press the <b>OK</b> button. Press it again to view the trip summary.

## Instantaneous Efficiency Level

The display ring increases as the instantaneous efficiency level increases and illuminates when it reaches maximum efficiency. The level continuously updates to indicate the efficiency level for the current trip.

# Driving Aids

## STEERING

### Electric Power Steering



**WARNING:** The electric power steering system has diagnostic checks that continuously monitor the system. If a fault is detected, a message displays in the information display. Stop your vehicle as soon as it is safe to do so. Switch the ignition off. After at least 10 seconds, switch the ignition on and watch the information display for a steering system warning message. If a steering system warning message returns, have the system checked by an authorized dealer.



**WARNING:** If the system detects an error, you may not feel a difference in the steering, however a serious condition may exist. Obtain immediate service from an authorized dealer, failure to do so may result in loss of steering control.

Your vehicle has an electric power steering system. There is no fluid reservoir. No maintenance is required.

If your vehicle loses electrical power while you are driving, electric power steering assistance is lost. The steering system still operates and you can steer your vehicle manually. Manually steering your vehicle requires more effort.

Extreme continuous steering may increase the effort required for you to steer your vehicle. This increased effort prevents overheating and permanent damage to the steering system. You do not lose the ability to steer your vehicle manually. Typical steering and driving maneuvers allow the system to cool and return to normal operation.

### Steering Tips

If the steering wanders or pulls, check for:

- Correct tire pressures.
- Uneven tire wear.
- Loose or worn suspension components.
- Loose or worn steering components.
- Improper vehicle alignment.

**Note:** *A high crown in the road or high crosswinds may also make the steering seem to wander or pull.*

### Adaptive Learning

The electronic power steering system adaptive learning helps correct road irregularities and improves overall handling and steering feel. It communicates with the brake system to help operate advanced stability control and accident avoidance systems. Additionally, whenever the battery is disconnected or a new battery installed, you must drive your vehicle a short distance before the system relearns the strategy and reactivates all systems.

## PRE-COLLISION ASSIST



**WARNING:** You are responsible for controlling your vehicle at all times. The system is designed to be an aid and does not relieve you of your responsibility to drive with due care and attention. Failure to follow this instruction could result in the loss of control of your vehicle, personal injury or death.



**WARNING:** The system does not operate during hard acceleration or steering. Failure to take care may lead to a crash or personal injury.

# Driving Aids

**WARNING:** The system may fail or operate with reduced function during cold and severe weather conditions. Snow, ice, rain, spray and fog can adversely affect the system. Keep the front camera and radar free of snow and ice. Failure to take care may result in the loss of control of your vehicle, serious personal injury or death.

**WARNING:** The system may not operate properly if your vehicle has a non-Ford windshield. Do not carry out windshield repairs in the area around the sensor.

**WARNING:** In situations where the vehicle camera has limited detection capability, this may reduce system performance. These situations include but are not limited to direct or low sunlight, vehicles at night without tail lights, unconventional vehicle types, pedestrians with complex backgrounds, running pedestrians, partly obscured pedestrians, or pedestrians that the system cannot distinguish from a group. Failure to take care may result in the loss of control of your vehicle, serious personal injury or death.

**WARNING:** The Pre-Collision Assist system with brake support cannot help prevent all collisions. Do not rely on this system to replace your judgment and the need to maintain correct distance and speed.

The pre-collision assist system is active when your vehicle reaches a speed greater than approximately 3 mph (5 km/h). Pedestrian detection is active at speeds up to 50 mph (80 km/h).

**Note:** *The system is not designed to detect animals.*

**Note:** *The system is not designed to detect vehicles or cyclists that are traveling in a different direction.*



E156130

If your vehicle is rapidly approaching a stationary vehicle, a vehicle or cyclist traveling in the same direction as yours, or a pedestrian within your driving path, the system is designed to provide three levels of functionality.

Level of Functionality	Description
Alert	When activated, a warning lamp flashes and an audible warning sounds.
Brake support	The system is designed to help reduce the impact speed by preparing the brakes for rapid braking. The system does not automatically apply the brakes. If you press the brake pedal, the system could apply additional braking up to maximum braking force, even if you lightly press the brake pedal.
Active braking - vehicles without adaptive cruise control	The system is designed to apply the brakes if it detects a crash is imminent. This may help reduce impact or avoid the crash.

# Driving Aids

Level of Functionality	Description
	The system is active at speeds up to 80 mph (130 km/h).
Active braking - vehicles with adaptive cruise control	The system is designed to apply the brakes if it detects a crash is imminent. This may help reduce impact or avoid the crash.

**To switch active braking on or off, use the information display controls on the steering wheel to select the following:**

Menu Item	Action
Driver Assist.	Press the menu button.
Pre-Collision Assist	Press the <b>OK</b> button.
Active Braking	Press the <b>OK</b> button.

## Distance Alert

A warning lamp illuminates if the distance to the vehicle ahead is small.

**Note:** *The warning lamp does not illuminate if cruise control or adaptive cruise control is active.*

## Distance Alert Sensitivity Settings

**To adjust the distance alert sensitivity settings, use the information display controls on the steering wheel to select the following:**

Menu Item	Action
Driver Assist.	Press the menu button.
Pre-Collision Assist	Press the <b>OK</b> button.
Alert Sensitivity	Press the <b>OK</b> button. Press the toggle button upward or downward to choose your required setting. Press the <b>OK</b> button.

## Distance Indication

A graphical indication displays the time gap to vehicles ahead of you traveling in the same direction.

**Note:** *The graphic does not display if you switch on cruise control or adaptive cruise control.*

# Driving Aids

Vehicle Speed	System Sensitivity	Distance Indicator Color	Distance Gap	Time Gap
62 mph (100 km/h)	Normal.	Gray.	Greater than 82.0 ft (25 m)	Greater than 0.9 seconds.
		Yellow.	55.8–82.0 ft (17–25 m)	0.6–0.9 seconds.
		Red.	Less than 55.8 ft (17 m).	Less than 0.6 seconds.

## Switching Distance Indication On or Off

To switch distance indication on or off, use the information display controls on the steering wheel to select the following:

Menu Item	Action
Driver Assist.	Press the menu button.
Pre-Collision Assist	Press the <b>OK</b> button.
Distance Indication	Press the <b>OK</b> button.

## Pre-Collision Assist System Sensors

### Vehicles without Adaptive Cruise Control



E243054

The camera is mounted behind the interior mirror.

**Note:** Keep the sensors free from snow, ice and large accumulations of dirt.

**Note:** Do not clean the sensors with sharp objects.

**Note:** If your vehicle sustains damage leaving the sensors misaligned, this may cause inaccurate measurements or false alerts.

Blocked sensors could affect system accuracy. A message may appear in the information display.

### Vehicles with Adaptive Cruise Control



E243054

# Driving Aids

The camera is mounted behind the interior mirror.



E244279

The radar sensor is behind the front grille below the license plate.

**Note:** *Keep the sensors free from snow, ice and large accumulations of dirt.*

**Note:** *Do not clean the sensors with sharp objects.*

**Note:** *If your vehicle sustains damage leaving the sensors misaligned, this may cause inaccurate measurements or false alerts.*

Blocked sensors could affect system accuracy. A message may appear in the information display.

## Pre-Collision Assist Warning Lamp



It illuminates if your vehicle rapidly approaches another vehicle, to warn you of the risk of a crash with the vehicle in front of you.

It could illuminate red if the distance to the vehicle ahead is small.

It illuminates amber when you switch the system off.

## Pre-Collision Assist Information Messages

Message	Action
Pre-Collision Assist Not Available	The system has malfunctioned. Have your vehicle checked as soon as possible.
Pre-Collision Assist Not Available Sensor Blocked	The sensors are dirty. Clean the sensors. If the message continues to appear, have your vehicle checked as soon as possible.

# Driving Aids

**The following table lists possible causes and actions for when a blocked sensor message may display.**

<b>Cause</b>	<b>Action</b>
The surface of the radar in the radiator grille is dirty or obstructed.	Clean the radiator grille in front of the radar or remove any obstruction.
The surface of the radar is clean but the message remains in the display.	Wait for a short period of time. It may take several minutes for the system to detect that there is no obstruction.
Heavy rain, spray, snow, or fog is interfering with the radar signals.	The system is temporarily disabled. The system should reactivate after a short period of time when the weather conditions improve.
The radar is misaligned.	Have your vehicle checked as soon as possible.
The windshield in front of the camera is dirty or obstructed.	Clean the outside of the windshield in front of the camera.
The windshield in front of the camera is clean but the message remains in the display.	Wait for a short period of time. It may take several minutes for the camera to detect that there is no obstruction.
Excessive heat around the camera.	Wait for a short period of time. The message should clear when the temperature around the camera decreases.



# Load Carrying

## LUGGAGE ANCHOR POINTS

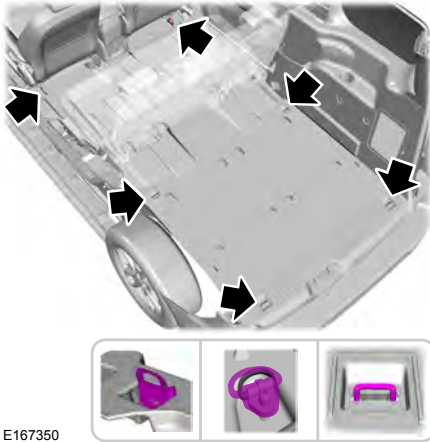

E167350

Variant	Maximum Load Value
Transit Courier	785 lb (357 kg)
Transit Connect	900 lb (408 kg)

## REAR UNDER FLOOR STORAGE

### Passenger Compartment Floor (If Equipped)

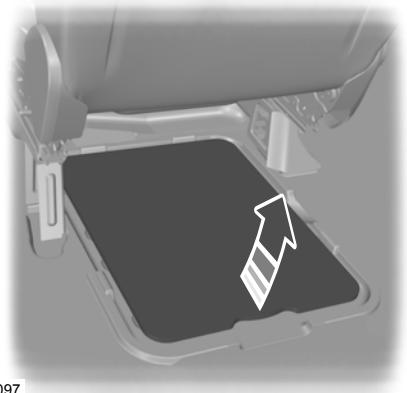

E78097

The under floor storage compartment is located behind the front passenger seat.

### Adjustable Load Floor (If Equipped)

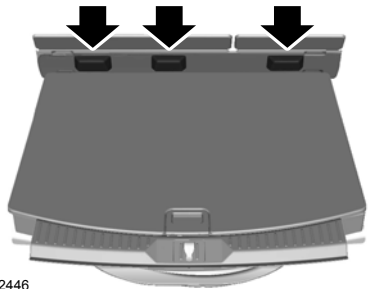

E142446

# Load Carrying

Vehicles with the standard size spare tire can adjust the load floor to two positions. The front of the load floor can be placed either on (for high position) or below (for low position) the ledges behind the rear seats. The rear of the load floor always sits on the two small shelves located on the liftgate trim.

## CARGO NETS

### Installing the Net (If Equipped)

 **WARNING:** Always attach and tighten the net to the luggage anchor points and do not put more than 22 lb (10 kg) of cargo behind the net and above the seat back. Otherwise, the net could fail and cargo could become a projectile, which could cause serious injury.

 **WARNING:** Do not allow people to ride in the third row seating positions when the cargo net is installed behind the second row. Failure to do so may limit egress from the vehicle in an emergency.

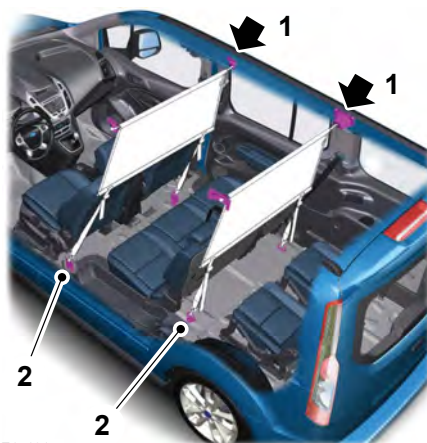

E171017

1. Push the ends of the upper bar toward each other and insert them into the retainers in the roof. Push the bar forward into the narrow section of the retainers.

# Load Carrying

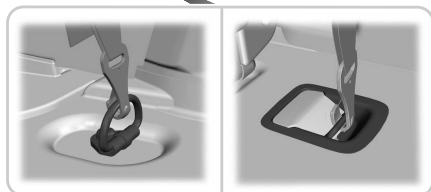
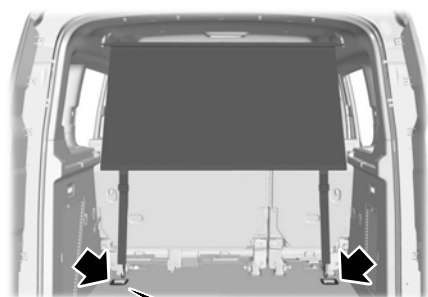

E167370

2. Attach the net to the luggage anchor points. See **Luggage Anchor Points** (page 221).

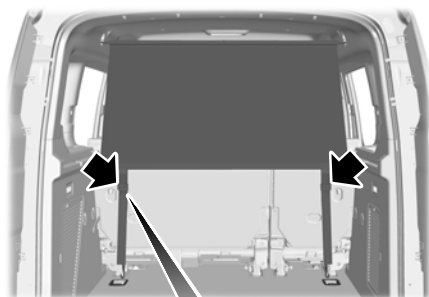

E167371

3. Tighten the straps.

# Load Carrying

## Removing the Net

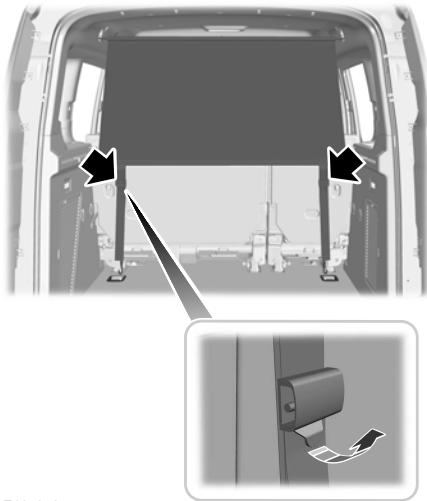

E167372

1. Release the straps.
2. Remove the net from the luggage anchor points.
3. Remove the upper bars.

## ROOF RACKS AND LOAD CARRIERS



**WARNING:** Read and follow the manufacturer's instructions when you are fitting a roof rack. Failure to take care may lead to a crash or personal injury.



**WARNING:** When loading the roof racks, we recommend you evenly distribute the load, as well as maintain a low center of gravity. Loaded vehicles, with higher centers of gravity, may handle differently than unloaded vehicles. Take extra

precautions, such as slower speeds and increased stopping distance, when driving a heavily loaded vehicle. Failure to take care may result in the loss of control of your vehicle, serious personal injury or death.

For correct roof rack system function, you must place loads directly on crossbars fitted to the roof rack side rails. When using the roof rack system, we recommend you use Ford genuine accessory crossbars designed specifically for your vehicle.

Make sure that you securely fasten the load. Check the tightness of the load before driving and at each fuel stop.

**Note:** *If you use a roof rack, the fuel consumption of your vehicle will be higher and you may experience different driving characteristics.*

**Note:** *Never place loads directly on the roof panel.*

## Maximum Load Weights

**Do not exceed the following maximum roof rack load weights.**

Variant	Maximum Load lb (kg)*
Wagon - short wheel base with panoramic roof panel	132 (60)
Wagon - short wheel base with metal roof panel	165 (75)
Wagon - long wheel base	165 (75)
Van	165 (75)

\*Evenly distribute the load on the roof rack.

# Load Carrying

## LOAD LIMIT

### Vehicle Loading - with and without a Trailer

This section guides you in the proper loading of your vehicle, trailer, or both. Keep your loaded vehicle weight within its design rating capability, with or without a trailer. Properly loading your vehicle provides maximum return of vehicle design performance. Before you load your vehicle, become familiar with the following terms for determining your vehicle's weight rating, with or without a trailer, from the vehicle's Tire and Loading Information label or Safety Compliance Certification label.

### Tire and Loading Label Information Example:

**TIRE AND LOADING INFORMATION**

SEATING CAPACITY TOTAL: 5 FRONT: 2 REAR: 3

The combined weight of occupants and cargo should never exceed: **385 kg or 850 lbs.**

TIRE	SIZE	COLD TIRE PRESSURE	SEE OWNERS MANUAL FOR ADDITIONAL INFORMATION
FRONT	235/45R18 94V	235 KPA, 34 PSI	
REAR	235/45R18 94V	235 KPA, 34 PSI	
SPARE	NONE	NONE	

**TIRE AND LOADING INFORMATION**  
**RENSEIGNEMENTS SUR LES PNEUS ET LE CHARGEMENT**

SEATING CAPACITY / NOMBRE DE PLACES TOTAL: 5 FRONT / AVANT: 2 REAR / ARRIERE: 3

The combined weight of occupants and cargo should never exceed 396 kg or 875 lbs.  
Le poids total des occupants et du chargement ne doit jamais dépasser

TIRE / PNEU	SIZE / DIMENSIONS	COLD TIRE PRESSURE / PRESSION DES PNEUS A FROID	SEE OWNER'S MANUAL FOR ADDITIONAL INFORMATION VOIR LE MANUEL DE L'USAGER POUR PLUS DE RENSEIGNEMENTS
FRONT / AVANT	235/40R19 96V	255 KPA, 37 PSI	
REAR / ARRIERE	235/40R19 96V	255 KPA, 37 PSI	
SPARE / DE SECOURS	T125/80R16 97M	415 KPA, 60 PSI	

E198719

## Payload

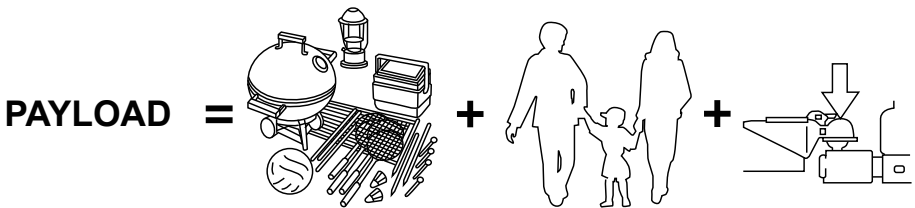

E143816

# Load Carrying

Payload is the combined weight of cargo and passengers that your vehicle is carrying. The maximum payload for your vehicle appears on the Tire and Loading label. The label is either on the B-pillar or the edge of the driver door. Vehicles exported outside the US and Canada may not have a tire and loading label. Look for “The combined weight of occupants and cargo should never exceed XXX kg OR XXX lb” for maximum payload. The payload listed on the Tire and Loading Information label is the maximum payload for your vehicle as built by the assembly plant. If you install any additional equipment on your vehicle, you must determine the new payload. Subtract the weight of the equipment from the payload listed on the Tire and Loading label. When towing, trailer tongue weight or king pin weight is also part of payload.

 **WARNING:** The appropriate loading capacity of your vehicle can be limited either by volume capacity (how much space is available) or by payload capacity (how much weight the vehicle should carry). Once you have reached the maximum payload of your vehicle, do not add more cargo, even if there is space available. Overloading or improperly loading your vehicle can contribute to loss of vehicle control and vehicle rollover.

## **GAWR (Gross Axle Weight Rating)**

GAWR is the maximum allowable weight that a single axle (front or rear) can carry. These numbers are on the Safety Compliance Certification label. The label is located on the door hinge pillar, door-latch post, or the door edge that meets the door-latch post, next to the driver seating position.

The total load on each axle must never exceed its Gross Axle Weight Rating.

## **GVWR (Gross Vehicle Weight Rating)**

GVWR is the maximum allowable weight of the fully loaded vehicle. This includes all options, equipment, passengers and cargo. It appears on the Safety Compliance Certification label. The label is located on the door hinge pillar, door-latch post, or the door edge that meets the door-latch post, next to the driver seating position.

The gross vehicle weight must never exceed the Gross Vehicle Weight Rating.

# Load Carrying

## Safety Compliance Certification Label Example:

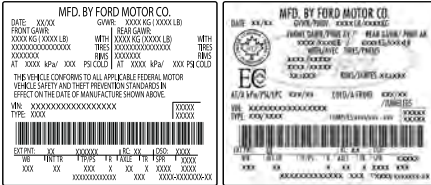

E 19828

**⚠ WARNING:** Exceeding the Safety Compliance Certification label vehicle weight limits can adversely affect the performance and handling of your vehicle, cause vehicle damage and can result in the loss of control of your vehicle, serious personal injury or death.

## Maximum Loaded Trailer Weight

Maximum loaded trailer weight is the highest possible weight of a fully loaded trailer the vehicle can tow. Consult an authorized dealer (or the RV and Trailer Towing Guide available at an authorized dealer) for more detailed information.

## GCWR (Gross Combined Weight Rating)

GCWR is the maximum allowable weight of the vehicle and the loaded trailer, including all cargo and passengers, that the vehicle can handle without risking damage. (Important: The towing

vehicle's braking system is rated for operation at Gross Vehicle Weight Rating, not at Gross Combined Weight Rating.) Separate functional brakes should be used for safe control of towed vehicles and for trailers where the Gross Combined Weight of the towing vehicle plus the trailer exceed the Gross Vehicle Weight Rating of the towing vehicle.

The gross combined weight must never exceed the Gross Combined Weight Rating.

**Note:** For trailer towing information refer to the *RV and Trailer Towing Guide* available at an authorized dealer.

**⚠ WARNING:** Do not exceed the GVWR or the GAWR specified on the certification label.

**⚠ WARNING:** Do not use replacement tires with lower load carrying capacities than the original tires because they may lower your vehicle's GVWR and GAWR limitations. Replacement tires with a higher limit than the original tires do not increase the GVWR and GAWR limitations.

# Load Carrying



**WARNING:** Exceeding any vehicle weight rating can adversely affect the performance and handling of your vehicle, cause vehicle damage and can result in the loss of control of your vehicle, serious personal injury or death.

## Steps for determining the correct load limit:

1. Locate the statement "The combined weight of occupants and cargo should never exceed XXX kg or XXX lb." on your vehicle's placard.
2. Determine the combined weight of the driver and passengers that will be riding in your vehicle.
3. Subtract the combined weight of the driver and passengers from XXX kg or XXX lb.
4. The resulting figure equals the available amount of cargo and luggage load capacity. For example, if the "XXX" amount equals 1,400 lb. and there will be five 150 lb. passengers in your vehicle, the amount of available cargo and luggage load capacity is 650 lb.  $(1400 - 750 (5 \times 150) = 650 \text{ lb.})$
5. Determine the combined weight of luggage and cargo being loaded on the vehicle. That weight may not safely exceed the available cargo and luggage load capacity calculated in Step 4.
6. If your vehicle will be towing a trailer, load from your trailer will be transferred to your vehicle. Consult this manual to determine how this reduces the available cargo and luggage load capacity of your vehicle.

## ***Helpful examples for calculating the available amount of cargo and luggage load capacity***

Suppose your vehicle has a 1400-pound (635-kilogram) cargo and luggage capacity. You decide to go golfing. Is there enough load capacity to carry you, four of your friends and all the golf bags? You and four friends average 220 pounds (99 kilograms) each and the golf bags weigh approximately 30 pounds (13.5 kilograms) each. The calculation would be:  $1400 - (5 \times 220) - (5 \times 30) = 1400 - 1100 - 150 = 150$  pounds. Yes, you have enough load capacity in your vehicle to transport four friends and your golf bags. In metric units, the calculation would be:  $635 \text{ kilograms} - (5 \times 99 \text{ kilograms}) - (5 \times 13.5 \text{ kilograms}) = 635 - 495 - 67.5 = 72.5$  kilograms.



## Load Carrying

Suppose your vehicle has a 1400-pound (635-kilogram) cargo and luggage capacity. You and one of your friends decide to pick up cement from the local home improvement store to finish that patio you have been planning for the past two years. Measuring the inside of the vehicle with the rear seat folded down, you have room for twelve 100-pound (45-kilogram) bags of cement. Do you have enough load capacity to transport the cement to your home? If you and your friend each weigh 220 pounds (99 kilograms), the calculation would be:  $1400 - (2 \times 220) - (12 \times 100) = 1400 - 440 - 1200 = -240$  pounds. No, you do not have enough cargo capacity to carry that much weight. In metric units, the calculation would be:  $635 \text{ kilograms} - (2 \times 99 \text{ kilograms}) - (12 \times 45 \text{ kilograms}) = 635 - 198 - 540 = -103$  kilograms. You will need to reduce the load weight by at least 240 pounds (104 kilograms). If you remove three 100-pound (45-kilogram) cement bags, then the load calculation would be:  $1400 - (2 \times 220) - (9 \times 100) = 1400 - 440 - 900 = 60$  pounds. Now you have the load capacity to transport the cement and your friend home. In metric units, the calculation would be:  $635 \text{ kilograms} - (2 \times 99 \text{ kilograms}) - (9 \times 45 \text{ kilograms}) = 635 - 198 - 405 = 32$  kilograms.

The above calculations also assume that the loads are positioned in your vehicle in a manner that does not overload the front or the rear gross axle weight rating specified for your vehicle on the Safety Compliance Certification label.

### Special Loading Instructions for Owners of Pick-up Trucks and Utility-type Vehicles



**WARNING:** When loading the roof racks, we recommend you evenly distribute the load, as well as maintain a low center of gravity. Loaded vehicles, with higher centers of gravity, may handle differently than unloaded vehicles. Take extra precautions, such as slower speeds and increased stopping distance, when driving a heavily loaded vehicle.

# Towing

## TOWING A TRAILER



**WARNING:** Towing trailers beyond the maximum recommended gross trailer weight exceeds the limit of your vehicle and could result in engine damage, transmission damage, structural damage, loss of vehicle control, vehicle rollover and personal injury.



**WARNING:** Do not exceed the GVWR or the GAWR specified on the certification label.

**Note:** See **Recommended Towing Weights** (page 231).

Your vehicle may have electrical items, such as fuses or relays, related to towing. See **Fuses** (page 254).

Your vehicle's load capacity designation is by weight, not by volume, so you cannot necessarily use all available space when loading a vehicle or trailer.

Towing a trailer places an extra load on your vehicle's engine, transmission, axle, brakes, tires and suspension. Inspect these components periodically during, and after, any towing operation.

## Load Placement

To help minimize how trailer movement affects your vehicle when driving:

- Load the heaviest items closest to the trailer floor.
- Load the heaviest items centered between the left and right side trailer tires.
- Load the heaviest items above the trailer axles or just slightly forward toward the trailer tongue. Do not allow the final trailer tongue weight to go above or below 10-15% of the loaded trailer weight.
- Select a ball mount with the correct rise or drop and load capacity. When both the loaded vehicle and trailer are connected, the trailer frame should be level, or slightly angled down toward your vehicle, when viewed from the side.

When driving with a trailer or payload, a slight takeoff vibration or shudder may be present due to the increased payload weight. Additional information regarding proper trailer loading and setting your vehicle up for towing is located in another chapter of this manual. See **Load Limit** (page 225).

You can also find information in the **RV & Trailer Towing Guide** available at your authorized dealer, or online.

# Towing

## RV & Trailer Towing Guide Online

Website | <http://www.fleet.ford.com/towing-guides/>

### TRAILER SWAY CONTROL

If the trailer begins to sway the stability control warning lamp flashes in the information display. The system applies the brakes to the individual wheels and reduces engine torque to aid vehicle stability.

Stop your vehicle as soon as it is safe to do so. Check the vertical weight on the tow ball and trailer load distribution. See **Capacities and Specifications** (page 327). See **Load Carrying** (page 221).

**Note:** *This feature does not prevent trailer sway, but reduces it once it begins.*

**Note:** *This feature cannot stop all trailers from swaying.*

**Note:** *In some cases, if your vehicle speed is too high, the system may turn on multiple times, gradually reducing your vehicle speed.*

### RECOMMENDED TOWING WEIGHTS

Your vehicle may tow a trailer. The maximum loaded trailer weight must be less than or equal to the maximum loaded trailer weight listed for your vehicle configuration on the following chart.

Do not exceed the maximum loaded trailer weight for your vehicle configuration listed in the chart below.

**Note:** *Make sure you take the trailer frontal area into consideration, do not exceed 20 feet<sup>2</sup> (1.86 meters<sup>2</sup>). Towing a trailer that exceeds this frontal area reduces the performance and fuel economy of your vehicle when towing. Select a trailer that has a rounded front and an aerodynamic design.*

**Note:** *For high altitude operation, reduce the gross combined weight by 2% per 1,000 ft (300 m) starting at the 1,000 ft (300 m) elevation point.*

**Note:** *Certain states require electric trailer brakes for trailers over a specified weight. Be sure to check state regulations for this specified weight. The maximum loaded trailer weights listed may be limited to this specified weight, as the vehicle's electrical system may not include the wiring connector needed to activate electric trailer brakes.*

# Towing

## Calculating the Maximum Loaded Trailer Weight

1. Start with the gross combined weight rating for your vehicle. See the following chart.
2. Subtract all of the following that apply to your vehicle:
  - Vehicle curb weight
  - Hitch hardware weight including: draw bar, tow ball, locks and weight distributing hardware
  - Driver and any passengers weight
  - Payload, cargo or luggage weight
  - Aftermarket equipment weight.

3. This equals the maximum loaded trailer weight for this combination.

**Note:** Remember to account for the trailer tongue weight as part of your vehicle load when calculating the total vehicle weight.

**Note:** Consult an authorized dealer to determine the maximum trailer weight allowed for your vehicle if you are not sure.

Powertrain	Maximum GCWR - lb (kg)	Maximum Loaded Trailer Weight - lb (kg) *
1.5L SWB Van - vehicles sold in the United States	6,061 (2,749)	2,000 (907)
1.5L SWB Wagon	6,210 (2,817)	2,000 (907)
1.5L LWB Van - vehicles sold in the United States	6,171 (2,799)	2,000 (907)
1.5L LWB Van - vehicles sold in Canada	6,131 (2,781)	2,000 (907)
1.5L LWB Wagon	6,499 (2,948)	2,000 (907)

## Towing

Powertrain	Maximum GCWR - lb (kg)	Maximum Loaded Trailer Weight - lb (kg) *
2.0L SWB Van - vehicles sold in the United States	5,939 (2,694)	2,000 (907)
2.0L LWB Van - vehicles sold in the United States	6,041 (2,740)	2,000 (907)
2.0L LWB Van - vehicles sold in Canada	6,001 (2,722)	2,000 (907)
2.0L LWB Wagon	6,380 (2,894)	2,000 (907)
2.5L SWB Van - vehicles sold in the United States	5,930 (2,690)	2,000 (907)
2.5L LWB Van - vehicles sold in the United States	6,041 (2,740)	2,000 (907)
2.5L LWB Van - vehicles sold in Canada	5,990 (2,717)	2,000 (907)
2.5L LWB Wagon	6,369 (2,889)	2,000 (907)

\* Calculated with SAE J2807 method.

### ESSENTIAL TOWING CHECKS

Follow these guidelines for safe towing:

- Do not tow a trailer until you drive your vehicle at least 1000 miles (1600 kilometers).
- Consult your local motor vehicle laws for towing a trailer.
- See the instructions included with towing accessories for the correct installation and adjustment specifications.
- Service your vehicle more frequently if you tow a trailer. See **Scheduled Maintenance** (page 416).
- If you use a rental trailer, follow the rental agency's instructions.

# Towing

Another chapter of this manual contains load specification terms found on the tire label and Safety Compliance label and instructions on calculating your vehicle's load. See **Load Limit** (page 225).

Remember to account for the trailer tongue weight as part of your vehicle load when calculating the total vehicle weight.

## Trailer Towing Connector



E168683

When attaching the trailer wiring connector to your vehicle, only use a proper fitting connector that works with the vehicle and trailer functions.

**Note:** You cannot use a seven-pin trailer wiring connector for your vehicle and the trailer lighting equipment.

Color	Function
Yellow	Left turn signal and stop lamp
White	Ground (-)
Green	Right turn signal and stop lamp
Brown	Running lights

## Hitches



**WARNING:** Do not tow a trailer that exceeds the maximum limit of the towing equipment. This could result in vehicle structural damage, loss of vehicle control and personal injury.

Do not use a hitch that either clamps onto the bumper or attaches to the axle.

Distribute the trailer load so that between 10% and 15% of the total trailer weight is on the tongue.

The hitch rating on the trailer hitch label is the maximum possible trailer rating. To find the maximum trailer weight allowed for your vehicle See **Recommended Towing Weights** (page 231). Further information is available in the RV and Trailer Towing Guide. See an authorized dealer.

## Safety Chains

Always connect the safety chains to the hook retainers of your vehicle hitch.

To connect the safety chains, cross them under the trailer tongue and allow enough slack for turning tight corners. Do not allow the chains to drag on the ground.

**Note:** Never attach safety chains to the bumper.

## Trailer Brakes



**WARNING:** Do not connect a trailer's hydraulic brake system directly to your vehicle's brake system. Your vehicle may not have enough braking power and your chances of having a crash greatly increase.

# Towing

Electric brakes and manual, automatic or surge-type trailer brakes are safe if you install them correctly and adjust them to the manufacturer's specifications. The trailer brakes must meet local and federal regulations.

The rating for the tow vehicle's braking system operation is at the gross vehicle weight rating, not the gross combined weight rating.

Separate functioning brake systems are required for safe control of towed vehicles and trailers weighing more than 1500 pounds (680 kilograms) when loaded.

## Trailer Lamps



**WARNING:** Never connect any trailer lamp wiring to the vehicle's tail lamp wiring; this may damage the electrical system resulting in fire. Contact an authorized dealer as soon as possible for assistance in correct trailer tow wiring installation. Additional electrical equipment may be required.

Trailer lamps are required on most towed vehicles. Make sure all running lights, brake lights, turn signals and hazard warning flashers are working.

## Before Towing a Trailer

Practice turning, stopping and backing up to get the feel of your vehicle-trailer combination before starting on a trip. When turning, make wider turns so the trailer wheels clear curbs and other obstacles.

## When Towing a Trailer

- Do not drive faster than 70 mph (113 km/h) during the first 500 miles (800 kilometers).
- Do not make full-throttle starts.

- Check the trailer hitch, electrical connections and trailer wheel lug nuts thoroughly after you have traveled 50 miles (80 kilometers).
- When stopped in congested or heavy traffic during hot weather, place the transmission selector lever in position **P** to aid engine and transmission cooling and to help A/C performance.
- Turn off the speed control with heavy loads or in hilly terrain. The speed control may turn off automatically when you are towing on long, steep grades.
- When driving down a long or steep hill, if your vehicle is fitted with a SelectShift Automatic® Transmission, use a low gear. See **Automatic Transmission** (page 169). Do not apply the brakes continuously, as they may overheat and become less effective.
- If the transmission is fitted with Grade Assist or a Towing feature, use this feature when towing. This provides engine braking and helps eliminate excessive transmission shifting for optimum fuel economy and transmission cooling.
- If your vehicle has AdvanceTrac with RSC and a heavily loaded trailer is on tow, the system may turn on while taking corners. This is normal. Taking corners at slower speeds can reduce this tendency.

# Towing

- Allow more distance for stopping with a trailer attached. Anticipate stops and brake gradually.
- Avoid parking on a grade. However, if you must park on a grade:
  - Turn the steering wheel to point your vehicle tires away from traffic flow.
  - Set the vehicle parking brake.
  - Place the transmission selector lever in position **P**.
  - Place wheel chocks in front and back of the trailer wheels. (Chocks not included with vehicle.)

## Launching or Retrieving a Boat or Personal Watercraft

**Note:** Disconnect the trailer wiring connector before the trailer enters the water.

**Note:** Reconnect the trailer wiring connector after the trailer is removed from the water.

When backing down a ramp during boat launching or retrieval:

- Do not allow the static water level to rise above the bottom edge of the rear bumper.
- Do not allow waves to break higher than 6 inches (15 centimeters) above the bottom edge of the rear bumper.

**Note:** Exceeding these limits may allow water to enter your vehicle or its components, affecting driveability, emissions and reliability. The vehicle warranty may not cover component damage caused by water entry.

Replace the rear axle lubricant anytime the rear axle has been submerged in water. Water may have contaminated the rear axle lubricant, which is not normally checked or changed unless a leak is suspected or other axle repair is required.

## TRANSPORTING THE VEHICLE

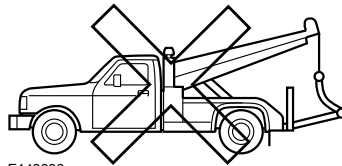
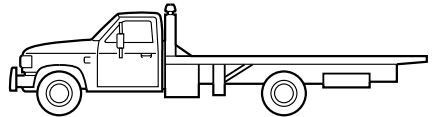
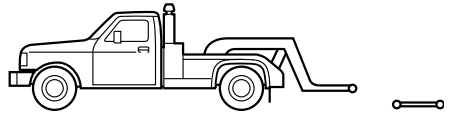

E143886

If you need to have your vehicle towed, contact a professional towing service or, if you are a member of a roadside assistance program, your roadside assistance service provider.

It is recommended that your vehicle be towed with a wheel lift and dollies or flatbed equipment. Do not tow with a slingbelt. Ford Motor Company has not approved a slingbelt towing procedure. If the vehicle is towed incorrectly, or by any other means, vehicle damage may occur.

Ford Motor Company produces a towing manual for all authorized tow truck operators. Have your tow truck operator refer to this manual for proper hook-up and towing procedures for your vehicle.



# Towing

You can tow your vehicle from the front with wheel lift equipment to raise the front wheels off the ground. We recommend that you place the rear wheels on a dolly to prevent damage to the rear of your vehicle.

You can tow your vehicle from the rear with wheel lift equipment.

**Note:** *You must place the front wheels on a dolly to prevent damage to the transmission.*

## TOWING THE VEHICLE ON FOUR WHEELS

### Emergency Towing



**WARNING:** If your vehicle has a steering wheel lock make sure the ignition is in the accessory or on position when being towed.

If your vehicle is disabled and you have no access to a tow dolly, car-hauling trailer or a flatbed transport vehicle, it can only be flat-towed with all wheels on the ground under the following conditions:

- Your vehicle is facing forward so that it is towed in a forward direction.
- The transmission selector lever is placed in position **N**. If the transmission gear shift lever cannot be moved to position **N**, it may need to be overridden. See **Automatic Transmission** (page 169).
- Maximum speed is 35 mph (56 km/h).
- Maximum distance is 50 mi (80 km).

Drive off slowly and smoothly without jerking the vehicle you are towing.

You must only use the towing eye that was delivered with your vehicle. See **Towing Points** (page 245).

Tow ropes or rigid towing bars must be placed on the same side. For example; right hand rear towing point to right hand front towing point.

You must use a tow rope or rigid towing bar that is of the correct strength for the weight of the towing vehicle and the vehicle that is being towed.

The weight of the vehicle that is being towed must not exceed the weight of the towing vehicle.

### Recreational Vehicle Towing

**Note:** *Put your climate control system in recirculated air mode to prevent exhaust fumes from entering the vehicle. See **Climate Control** (page 108).*

Follow these guidelines if you have a need for recreational (RV) towing. An example of recreational towing would be towing your vehicle behind a motorhome. We designed these guidelines to prevent damage to your transmission.

Front-wheel drive vehicles **CANNOT** be flat-towed (all wheels on the ground), as transmission damage may occur. You can tow your vehicle with the front wheels off the ground by using a tow dolly. If you are using a tow dolly, follow the instructions specified by the equipment provider.

# Driving Hints

## BREAKING-IN

You need to break in new tires for approximately 300 mi (480 km). During this time, your vehicle may exhibit some unusual driving characteristics.

Avoid driving too fast during the first 1,000 mi (1,600 km). Vary your speed frequently and change up through the gears early. Do not labor the engine.

Do not tow during the first 1,000 mi (1,600 km).

## REDUCED ENGINE PERFORMANCE



**WARNING:** If you continue to drive your vehicle when the engine is overheating, the engine could stop without warning. Failure to follow this instruction could result in the loss of control of your vehicle.

If the engine coolant temperature gauge needle moves to the upper limit position, the engine is overheating. See **Gauges** (page 87).

You must only drive your vehicle for a short distance if the engine overheats. The distance you can travel depends on ambient temperature, vehicle load and terrain. The engine continues to operate with limited power for a short period of time.

If the engine temperature continues to rise, the fuel supply to the engine reduces. The air conditioning switches off and the engine cooling fan operates continually.

1. Gradually reduce your speed and stop your vehicle as soon as it is safe to do so.

2. Immediately switch the engine off to prevent severe engine damage.
3. Wait for the engine to cool down.
4. Check the coolant level. See **Engine Coolant Check** (page 268).
5. Have your vehicle checked as soon as possible.

## ECONOMICAL DRIVING

Fuel economy is affected by several things such as how you drive, the conditions you drive under and how you maintain your vehicle.

There are some things to keep in mind that may improve your fuel economy:

- Accelerate and slow down in a smooth, moderate fashion.
- Drive at steady speeds.
- Anticipate stops; slowing down may eliminate the need to stop.
- Combine errands and minimize stop-and-go driving (When running errands, go to the furthest destination first and then work your way back home).
- Close the windows for high-speed driving.
- Drive at reasonable speeds.
- Keep the tires properly inflated and use only the recommended size.
- Use the recommended engine oil.
- Perform all regularly scheduled maintenance.

There are also some things you may want to avoid doing because they reduce your fuel economy:

- Avoid sudden or hard accelerations.
- Avoid revving the engine before turning off the car.
- Avoid long idle periods.

# Driving Hints

- Do not warm up your vehicle on cold mornings.
- Reduce the use of air conditioning and heat.
- Avoid using speed control in hilly terrain.
- Do not rest your foot on the brake pedal while driving.
- Avoid carrying unnecessary weight.
- Avoid adding particular accessories to your vehicle (e.g. bug deflectors, rollbars/light bars, running boards, ski racks).
- Avoid driving with the wheels out of alignment.

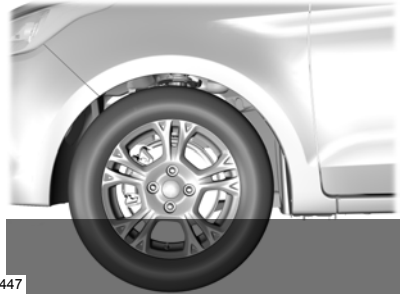

When driving through standing water, drive very slowly and do not stop your vehicle. Your brake performance and traction may be limited. After driving through water and as soon as it is safe to do so:

- Lightly press the brake pedal to dry the brakes and to check that they work.
- Check that the horn works.
- Check that the exterior lights work.
- Turn the steering wheel to check that the steering power assist works.

## COLD WEATHER PRECAUTIONS

The functional operation of some components and systems can be affected at temperatures below -13°F (-25°C).

## DRIVING THROUGH WATER

 **WARNING:** Do not drive through flowing or deep water as you may lose control of your vehicle.

**Note:** *Driving through standing water can cause vehicle damage.*

**Note:** *Engine damage can occur if water enters the air filter.*

Before driving through standing water, check the depth. Never drive through water that is higher than the bottom of the front rocker area of your vehicle.

## FLOOR MATS

 **WARNING:** Use a floor mat designed to fit the footwell of your vehicle that does not obstruct the pedal area. Failure to follow this instruction could result in the loss of control of your vehicle, personal injury or death.

 **WARNING:** Pedals that cannot move freely can cause loss of vehicle control and increase the risk of serious personal injury.

# Driving Hints

 **WARNING:** Secure the floor mat to both retention devices so that it cannot slip out of position and interfere with the pedals. Failure to follow this instruction could result in the loss of control of your vehicle, personal injury or death.

 **WARNING:** Do not place additional floor mats or any other covering on top of the original floor mats. This could result in the floor mat interfering with the operation of the pedals. Failure to follow this instruction could result in the loss of control of your vehicle, personal injury or death.

 **WARNING:** Always make sure that objects cannot fall into the driver foot well while your vehicle is moving. Objects that are loose can become trapped under the pedals causing a loss of vehicle control.



E142666

To install the floor mats, position the floor mat eyelet over the retention post and press down to lock in position.

To remove the floor mat, reverse the installation procedure.

**Note:** *Regularly check the floor mats to make sure they are secure.*

# Roadside Emergencies

---

## ROADSIDE ASSISTANCE

### Vehicles Sold in the United States: Getting Roadside Assistance

To fully assist you should you have a vehicle concern, Ford Motor Company offers a complimentary roadside assistance program. This program is separate from the New Vehicle Limited Warranty.

The service is available:

- 24 hours a day, seven days a week.
- For the coverage period listed on the Roadside Assistance Card included in your Owner's Manual portfolio.

Roadside Assistance covers:

- A flat tire change with a good spare (except vehicles supplied with a tire inflation kit).
- Battery jump start.
- Lock-out assistance (key replacement cost is the customer's responsibility).
- Fuel delivery — independent service contractors, if not prohibited by state, local or municipal law, shall deliver up to 2 gal (8 L) of gasoline or 5 gal (20 L) of diesel fuel to a disabled vehicle. Roadside Assistance limits fuel delivery service to two no-charge occurrences within a 12-month period.
- Winch out — available within 100 ft (30 m) of a paved or county maintained road, no recoveries.

- Towing — independent service contractors, if not prohibited by state, local or municipal law, shall tow Ford eligible vehicles to an authorized dealer within 35 mi (56 km) of the disablement location or to the nearest authorized dealer. If a member requests a tow to an authorized dealer that is more than 35 mi (56 km) from the disablement location, the member shall be responsible for any mileage costs in excess of 35 mi (56 km).
- Roadside Assistance includes up to \$200 for a towed trailer if the disabled eligible vehicle requires service at the nearest authorized dealer. If the towing vehicle is operational but the trailer is not, then the trailer does not qualify for any roadside services.

### Vehicles Sold in the United States: Using Roadside Assistance

Complete the roadside assistance identification card and place it in your wallet for quick reference. This card is in the owner's information portfolio in the glove compartment.

United States vehicle customers who require Roadside Assistance, call 1-800-241-3673.

If you need to arrange roadside assistance for yourself, Ford Motor Company reimburses a reasonable amount for towing to the nearest dealership within 35 mi (56 km). To obtain reimbursement information, United States vehicle customers call 1-800-241-3673. Customers need to submit their original receipts.

# Roadside Emergencies

## Vehicles Sold in Canada: Getting Roadside Assistance

To fully assist you should you have a vehicle concern, Ford Motor Company of Canada, Limited offers a complimentary roadside assistance program. This program is eligible within Canada or the continental United States.

This program is separate from the New Vehicle Limited Warranty, but the coverage is concurrent with the powertrain coverage period of your vehicle.

Canadian customers who require roadside assistance, call 1-800-665-2006.

## Vehicles Sold in Canada: Using Roadside Assistance

Complete the roadside assistance identification card and place it in your wallet for quick reference.

In Canada, this card is found in the Warranty Guide in the glove compartment of your vehicle.

## Vehicles Sold in Canada: Roadside Assistance Program Coverage

The service is available 24 hours a day, seven days a week.

Canadian roadside coverage and benefits may differ from the U.S. coverage.

If you require more information, please refer to the coverage section of your warranty guide, call us in Canada at 1-800-665-2006, or visit our website at [www.ford.ca](http://www.ford.ca).

## HAZARD FLASHERS

**Note:** *If used when the vehicle is not running, the battery will lose charge. There may be insufficient power to restart your vehicle.*



The hazard warning button is located on the instrument panel. Use it when your vehicle is creating a safety hazard for other motorists.

- Press the button to turn on the hazard warning function, and the front and rear direction indicators will flash.
- Press the button again to turn them off.

## FUEL SHUTOFF



**WARNING:** Failure to inspect and if necessary repair fuel leaks after a crash may increase the risk of fire and serious injury. We recommend that the fuel system be inspected by an authorized dealer after any crash.

In the event of a moderate to severe crash, your vehicle is fitted with a fuel pump shut-off feature that stops the flow of fuel to the engine. Not every impact will cause a shut-off.

Should the engine turn off after a crash, you may restart the engine by carrying out the following.

### Ignition Switch

1. Switch the ignition off.
2. Switch the ignition to position **III**.
3. Switch the ignition off.
4. Switch the ignition on again to re-enable the fuel pump.

**Note:** *Various system checks are automatically carried out before the vehicle will restart. If your vehicle fails to restart after the third attempt, the system has detected a fault that requires service. We recommend you contact an authorized dealer.*

# Roadside Emergencies

## Keyless Starting (If Equipped)

1. Without applying the brake pedal, press and release the button once.
2. Press the brake pedal, and then press and release the button once.
3. Without applying the brake pedal, press and release the button once.
4. Press the brake pedal, and then press and hold the button until the engine starts.

**Note:** Various system checks are automatically carried out before the vehicle will restart. If your vehicle fails to restart after the third attempt, the system has detected a fault that requires service. We recommend you contact an authorized dealer.

## JUMP STARTING THE VEHICLE



**WARNING:** The gases around the battery can explode if exposed to flames, sparks or lit cigarettes. An explosion could result in personal injury or vehicle damage.



**WARNING:** Batteries contain sulfuric acid which can burn skin, eyes and clothing, if contacted.



**WARNING:** Use only an adequate-sized cable with insulated clamps.

**Note:** Do not disconnect the battery from your vehicle's electrical system.

## Preparing Your Vehicle

**Note:** Do not attempt to push-start your automatic transmission vehicle. Automatic transmissions do not have push-start capability. Attempting to push-start a vehicle with an automatic transmission may cause transmission damage.

**Note:** Use only a 12-volt supply to start your vehicle.

**Note:** Do not disconnect the battery of the disabled vehicle as this could damage the vehicle's electrical system.

Park the booster vehicle close to the hood of the disabled vehicle, making sure the two vehicles do not touch, and switch off all accessories.

## Connecting the Jumper Cables



**WARNING:** Do not attach the cables to fuel lines, engine rocker covers, the intake manifold or electrical components as grounding points. Stay clear of moving parts. To avoid reverse polarity connections, make sure that you correctly identify the positive (+) and negative (-) terminals on both the disabled and booster vehicles before connecting the cables.

**Note:** In the illustration, the bottom vehicle represents the booster vehicle.

# Roadside Emergencies

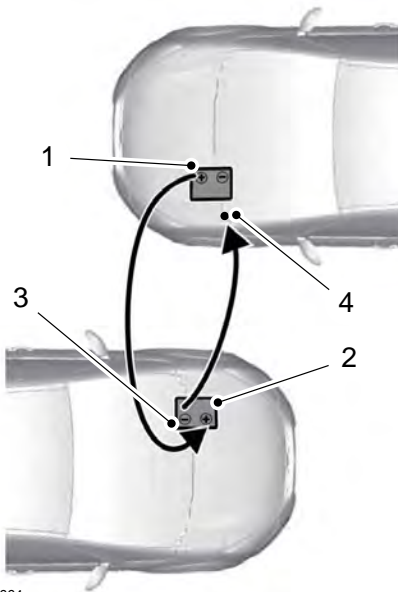

E142664

1. Connect the positive (+) jumper cable to the positive (+) terminal of the discharged battery.
2. Connect the other end of the positive (+) cable to the positive (+) terminal of the assisting battery.
3. Connect the negative (-) cable to the negative (-) terminal of the assisting battery.
4. Make the final connection of the negative (-) cable to an exposed metal part of the stalled vehicle's engine, or connect the negative (-) cable to a ground connection point if available.

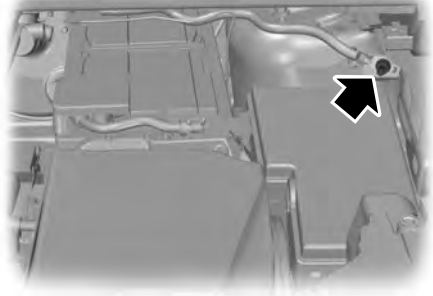

E130431



**WARNING:** Do not connect the end of the second cable to the negative (-) terminal of the battery to be jumped. A spark may cause an explosion of the gases that surround the battery.

## Jump Starting

1. Start the engine of the booster vehicle and rev the engine moderately, or press the accelerator gently to keep your engine speed between 2000 and 3000 rpms, as shown in your tachometer.
2. Start the engine of the disabled vehicle.
3. After starting the disabled vehicle, run both vehicle engines for an additional three minutes before disconnecting the jumper cables.

## Removing the Jumper Cables

Remove the jumper cables in the reverse order that they were connected.



# Roadside Emergencies

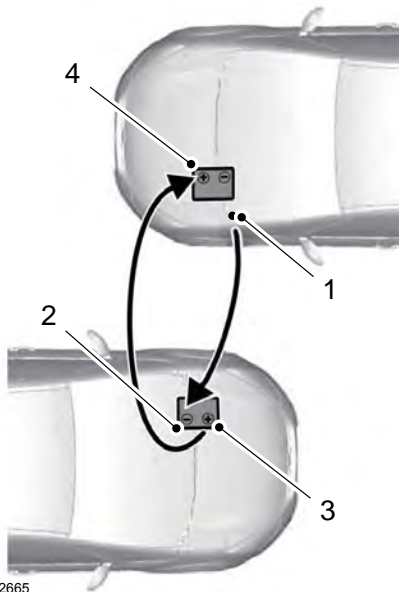

E142665

1. Remove the jumper cable from the ground metal surface or connecting point, if available.
2. Remove the jumper cable on the negative (-) terminal of the booster vehicle's battery.
3. Remove the jumper cable from the positive (+) terminal of the booster vehicle's battery.
4. Remove the jumper cable from the positive (+) terminal of the disabled vehicle's battery.

After starting your vehicle and removing the jumper cables, allow it to idle for several minutes so the battery can recharge.

## POST-CRASH ALERT SYSTEM

The system flashes the turn signal lamps and sounds the horn (intermittently) in the event of a serious impact that deploys an airbag (front, side, side curtain or Safety Canopy) or the seatbelt pretensioners.

The horn and lamps will turn off when:

- The hazard control button is pressed
- The panic button (if equipped) is pressed on the remote entry transmitter
- Your vehicle runs out of power

## TOWING POINTS

### Front Towing Point

 **WARNING:** Make sure that the towing eye is fully tightened. Failure to follow this instruction could result in personal injury.

 **WARNING:** You must switch the ignition on when your vehicle is being towed.

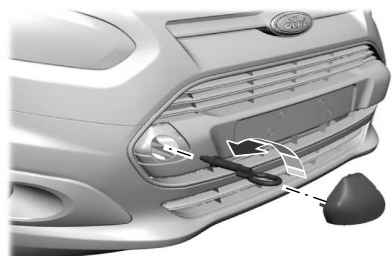

E165018

1. Carefully remove the cover.
2. Install the towing eye.

# Roadside Emergencies

**Note:** It has a left-hand thread. Turn it counterclockwise to install it.

## Rear Towing Point

 **WARNING:** Make sure that the towing eye is fully tightened. Failure to follow this instruction could result in personal injury.



E165019

1. Carefully remove the cover.
2. Install the towing eye.

**Note:** It has a left-hand thread. Turn it counterclockwise to install it.

## Towing Eye Location

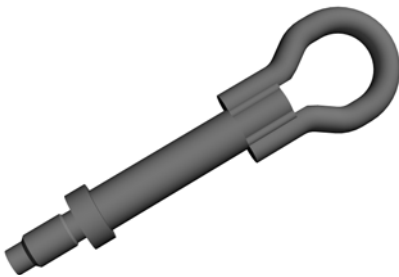

E265227

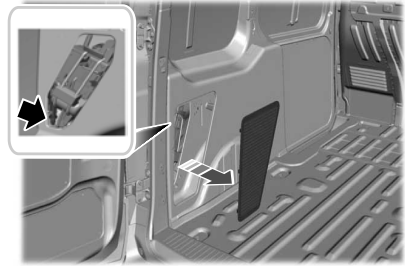

E165020

The towing eye is in the luggage compartment on the left-hand side.

**Note:** You must carry the towing eye in your vehicle at all times.

# Customer Assistance

## GETTING THE SERVICES YOU NEED

Warranty repairs to your vehicle must be performed by an authorized dealer. While any authorized dealer handling your vehicle line will provide warranty service, we recommend you return to your selling authorized dealer who wants to ensure your continued satisfaction.

Please note that certain warranty repairs require special training and equipment, so not all authorized dealers are authorized to perform all warranty repairs. This means that, depending on the warranty repair needed, you may have to take your vehicle to another authorized dealer.

A reasonable time must be allowed to perform a repair after taking your vehicle to the authorized dealer. Repairs will be made using Ford or Motorcraft® parts, or remanufactured or other parts that are authorized by Ford.

### Away From Home

If you are away from home when your vehicle needs service, contact the Ford Customer Relationship Center or use the online resources listed below to find the nearest authorized dealer.

In the United States:

#### Mailing address

Ford Motor Company  
Customer Relationship Center  
P.O. Box 6248  
Dearborn, MI 48126

#### Telephone

1-800-392-3673 (FORD)  
(TDD for the hearing impaired:  
1-800-232-5952)

Additional information and resources are available online:

Website
<a href="http://www.owner.ford.com">www.owner.ford.com</a>

These are some of the items that can be found online:

- U.S. dealer locator by Dealer Name, City/State or Zip Code.
- Owner Manuals.
- Maintenance Schedules.
- Recalls.
- Ford Extended Service Plans.
- Ford Genuine Accessories.
- Service specials and promotions.

In Canada:

#### Mailing address

Customer Relationship Centre  
Ford Motor Company of Canada, Limited  
P.O. Box 2000  
Oakville, Ontario L6K 0C8

#### Telephone

1-800-565-3673 (FORD)

Website
<a href="http://www.ford.ca">www.ford.ca</a>

#### Twitter

@FordServiceCA (English Canada)  
@FordServiceQC (Quebec)

#### Additional Assistance

If you have questions or concerns, or are unsatisfied with the service you are receiving, follow these steps:

1. Contact your Sales Representative or Service Advisor at your selling or servicing authorized dealer.

# Customer Assistance

---

2. If your inquiry or concern remains unresolved, contact the Sales Manager, Service Manager or Customer Relations Manager.
3. If you require assistance or clarification on Ford Motor Company policies, please contact the Ford Customer Relationship Center.

In order to help us serve you better, please have the following information available when contacting a Customer Relationship Center:

- Vehicle Identification Number.
- Your telephone number (home and business).
- The name of the authorized dealer and city where located.
- The vehicle's current odometer reading.

In some states within the United States, you must directly notify Ford in writing before pursuing remedies under your state's warranty laws, and Ford is also allowed a final repair attempt.

Additionally, in some states within the United States, a consumer has the option of submitting a warranty dispute to the BBB Auto Line before taking action under the Magnuson-Moss Warranty Act, or to the extent allowed by state law, before pursuing replacement or repurchase remedies provided by certain state laws. This dispute handling procedure is not required prior to enforcing state created rights or other rights which are independent of the Magnuson-Moss Warranty Act or state replacement or repurchase laws.

## IN CALIFORNIA (U.S. ONLY)

California Civil Code Section 1793.2(d) requires that, if a manufacturer or its representative is unable to repair a motor vehicle to conform to the vehicle's applicable express warranty after a reasonable number of attempts, the manufacturer shall be required to either replace the vehicle with one substantially identical or repurchase the vehicle and reimburse the buyer in an amount equal to the actual price paid or payable by the consumer (less a reasonable allowance for consumer use). The consumer has the right to choose whether to receive a refund or replacement vehicle.

California Civil Code Section 1793.22(b) presumes that the manufacturer has had a reasonable number of attempts to conform the vehicle to its applicable express warranties if, within the first 18 months of ownership of a new vehicle or the first 18,000 mi (29,000 km), whichever occurs first:

1. Two or more repair attempts are made on the same non-conformity likely to cause death or serious bodily injury OR
2. Four or more repair attempts are made on the same nonconformity (a defect or condition that substantially impairs the use, value or safety of the vehicle) OR
3. The vehicle is out of service for repair of nonconformities for a total of more than 30 calendar days (not necessarily all at one time).

In the case of 1 or 2 above, the consumer must also notify the manufacturer of the need for the repair of the nonconformity at the following address:

Ford Motor Company  
16800 Executive Plaza Drive  
Mail Drop 3NE-B  
Dearborn, MI 48126

## Customer Assistance

---

You are required to submit your warranty dispute to BBB AUTO LINE before asserting in court any rights or remedies conferred by California Civil Code Section 1793.22(b). You are also required to use BBB AUTO LINE before exercising rights or seeking remedies created by the Federal Magnuson-Moss Warranty Act, 15 U.S.C. sec. 2301 et seq. If you choose to seek redress by pursuing rights and remedies not created by California Civil Code Section 1793.22(b) or the Magnuson-Moss Warranty Act, resort to BBB AUTO LINE is not required by those statutes.

### **THE BETTER BUSINESS BUREAU (BBB) AUTO LINE PROGRAM (U.S. ONLY)**

Your satisfaction is important to Ford Motor Company and to your dealer. If a warranty concern has not been resolved using the three-step procedure outlined earlier in this chapter in the Getting the Services you need section, you may be eligible to participate in the BBB AUTO LINE program.

The BBB AUTO LINE program consists of two parts – mediation and arbitration. During mediation, a representative of the BBB will contact both you and Ford Motor Company to explore options for settlement of the claim. If an agreement is not reached during mediation or you do not want to participate in mediation, and if your claim is eligible, you may participate in the arbitration process. An arbitration hearing will be scheduled so that you can present your case in an informal setting before an impartial person. The arbitrator will consider the testimony provided and make a decision after the hearing.

Disputes submitted to the BBB AUTO LINE program are usually decided within forty days after you file your claim with the BBB. You are not bound by the decision, and may reject the decision and proceed to court where all findings of the BBB Auto Line dispute, and decision, are admissible in the court action. Should you choose to accept the BBB AUTO LINE decision, Ford is then bound by the decision, and must comply with the decision within 30 days of receipt of your acceptance letter.

**BBB AUTO LINE Application:** Using the information provided below, please call or write to request a program application. You will be asked for your name and address, general information about your new vehicle, information about your warranty concerns, and any steps you have already taken to try to resolve them. A Customer Claim Form will be mailed that will need to be completed, signed and returned to the BBB along with proof of ownership. Upon receipt, the BBB will review the claim for eligibility under the Program Summary Guidelines.

**You can get more information by calling BBB AUTO LINE at 1-800-955-5100, or writing to:**

**BBB AUTO LINE  
3033 Wilson Boulevard, Suite 600  
Arlington, Virginia 22201**

BBB AUTO LINE applications can also be requested by calling the Ford Motor Company Customer Relationship Center at 1-800-392-3673.

**Note:** *Ford Motor Company reserves the right to change eligibility limitations, modify procedures, or to discontinue this process at any time without notice and without obligation.*

# Customer Assistance

---

## UTILIZING THE MEDIATION/ARBITRATION PROGRAM (CANADA ONLY)

For vehicles delivered to authorized Canadian dealers. In those cases where you continue to feel that the efforts by Ford of Canada and the authorized dealer to resolve a factory-related vehicle service concern have been unsatisfactory, Ford of Canada participates in an impartial third party mediation/arbitration program administered by the Canadian Motor Vehicle Arbitration Plan (CAMVAP).

The CAMVAP program is a straight forward and relatively speedy alternative to resolve a disagreement when all other efforts to produce a settlement have failed. This procedure is without cost to you and is designed to eliminate the need for lengthy and expensive legal proceedings.

In the CAMVAP program, impartial third-party arbitrators conduct hearings at mutually convenient times and places in an informal environment. These impartial arbitrators review the positions of the parties, make decisions and, when appropriate, render awards to resolve disputes. CAMVAP decisions are fast, fair, and final as the arbitrator's award is binding on both you and Ford of Canada.

CAMVAP services are available in all Canadian territories and provinces. For more information, without charge or obligation, call your CAMVAP Provincial Administrator directly at 1-800-207-0685 or visit [www.camvap.ca](http://www.camvap.ca).

## GETTING ASSISTANCE OUTSIDE THE U.S. AND CANADA

Before exporting your vehicle to a foreign country, contact the appropriate foreign embassy or consulate. These officials can inform you of local vehicle registration regulations and where to find unleaded fuel or petrol/gas engines or the proper sulfur fuel for diesel engines.

If you cannot find the proper fuel recommended for your vehicle, contact our Customer Relationship Center.

The use of improper fuels in your vehicle without proper conversion may damage the effectiveness of your emission control system and may cause engine knocking or serious engine damage. Ford Motor Company or Ford of Canada is not responsible for any damage caused by use of improper fuel. Using improper fuels may also result in difficulty importing your vehicle back into the United States.

If your vehicle must be serviced while you are traveling or living in Asia-Pacific Region, Sub-Saharan Africa, U.S. Virgin Islands and/or Puerto Rico, Central America, the Caribbean, and Israel and the Middle East, contact the nearest authorized dealer. If the authorized dealer cannot help you, contact the corresponding Ford Customer Assistance Center:

**FORD MOTOR COMPANY**  
**Customer Relationship Centers in:**

## Customer Assistance

Customer Relationship Center	Phone	Fax	E-mail
Asia Pacific	N/A	N/A	apemcrc@ford.com
Caribbean and Central America	+1 313 594 4857	-	expcac@ford.com
Middle East	Ford 80004443673	971 4 3327 266	menacac@ford.com
	Lincoln 80004441066		
	UAE 80004441066		
	Saudi Arabia 8008443673		
	Mobily and Zain cell phone users in Saudi 800850078		
North Africa	N/A	N/A	nafcrc@ford.com
Puerto Rico and U.S. Virgin Islands	+1-800-841-3673	N/A	prcac@ford.com
Sub-Saharan Africa	+1-313-594-4857	N/A	ssacrc@ford.com
South Korea	+82-02-1600-6003	N/A	infokr1@ford.com or infokr@lincoln.com

If you buy your vehicle in North America and then relocate to any of the above locations, register your vehicle identification number (VIN) and new address with Ford Global Trade Services by emailing, [expcso@ford.com](mailto:expcso@ford.com).

If you are in another foreign country, contact the nearest authorized dealer. In the event your inquiry is unresolved, communicate your concern with the dealership's Sales Manager, Service Manager or Customer Relations Manager. If you require additional assistance or clarification, please contact the respective Customer Relationship Center as previously listed.

**Customers in the U.S. should call 1-800-392-3673.**

## Customer Assistance

---

### **ORDERING ADDITIONAL OWNER'S LITERATURE**

To order the publications in this portfolio, contact Helm, Incorporated at:

HELM, INCORPORATED  
47911 Halyard Drive  
Plymouth, Michigan 48170  
Attention: Customer Service

Or to order a free publication catalog, call toll free: 1-800-782-4356

Monday-Friday 8:00 a.m. - 6:00 p.m. EST

Helm, Incorporated can also be reached by their website:

[www.helminc.com](http://www.helminc.com)

(Items in this catalog may be purchased by credit card, check or money order.)

### **Obtaining a French Owner's Manual**

French Owner's Manual can be obtained from your authorized dealer or by contacting Helm, Incorporated using the contact information listed previously in this section.

### **REPORTING SAFETY DEFECTS (U.S. ONLY)**



E142557

If you believe that your vehicle has a defect which could cause a crash or could cause injury or death, you should immediately inform the National Highway Traffic Safety Administration (NHTSA) in addition to notifying Ford Motor Company.

If NHTSA receives similar complaints, it may open an investigation, and if it finds that a safety defect exists in a group of vehicles, it may order a recall and remedy campaign. However, NHTSA cannot become involved in individual problems between you, your dealer, or Ford Motor Company.

To contact NHTSA, you may call the Vehicle Safety Hotline toll-free at 1-888-327-4236 (TTY: 1-800-424-9153); go to <http://www.safercar.gov>; or write to:

Administrator

1200 New Jersey Avenue,  
Southeast

Washington, D.C. 20590

You can also obtain other information about motor vehicle safety from <http://www.safercar.gov>.

### **REPORTING SAFETY DEFECTS (CANADA ONLY)**

If you believe that your vehicle has a defect which could cause a crash or could cause injury or death, you should immediately inform Transport Canada and Ford of Canada.



# Customer Assistance

---

<b>Transport Canada Contact Information</b>	
Website	<a href="http://www.tc.gc.ca/eng/motorvehiclesafety/reporting-defects-motor-vehicles.html">http://www.tc.gc.ca/eng/motorvehiclesafety/reporting-defects-motor-vehicles.html</a> (English)
Website	<a href="http://www.tc.gc.ca/fra/securiteautomobile/signaler-defauts-vehicules-automobiles.html">http://www.tc.gc.ca/fra/securiteautomobile/signaler-defauts-vehicules-automobiles.html</a> (French)
Phone	1-800-333-0510

<b>Ford of Canada Contact Information</b>	
Website	<a href="http://www.ford.ca">www.ford.ca</a>
Phone	1-800-565-3673

# Fuses

## FUSE BOX LOCATIONS

### Engine Compartment Fuse Box



E272439

The fuse box is in the engine compartment. See **Maintenance** (page 261).

### Passenger Compartment Fuse Box

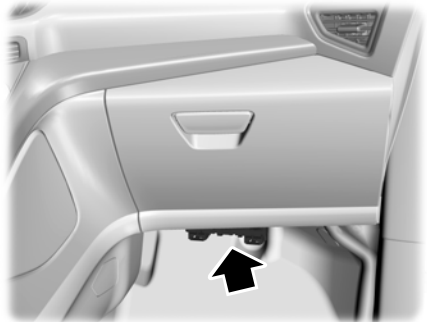

E159113

The fuse box is below the glove box.

## FUSE SPECIFICATION CHART

# Fuses

## Engine Compartment Fuse Box

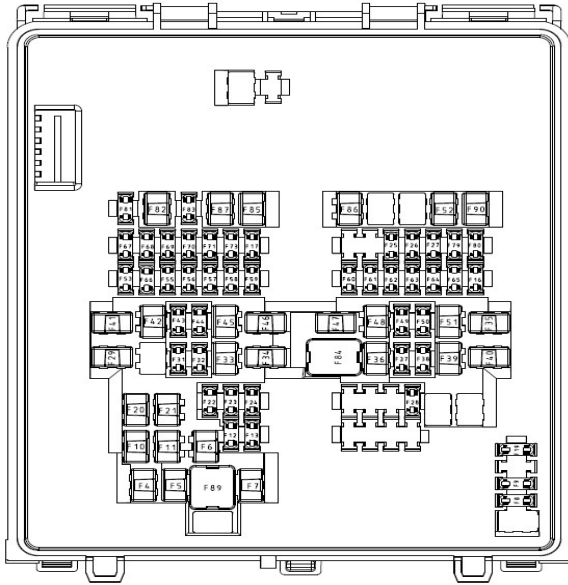

E272453

Fuse Location	Fuse Rating	Protected Component
4	20 A	Cooling fan.
	25 A	Water-in-fuel sensor - diesel.
6	15 A	Windshield wipers.
7	15 A	Windshield wipers.
8	15 A	Rear window washer pump.
9	10 A	Rear cargo door unlock. Liftgate unlock.
10	20 A	Rear floor console auxiliary power point.
11	20 A	Floor console auxiliary power point.
12	5 A	Rain sensor.

## Fuses

Fuse Location	Fuse Rating	Protected Component
13	20 A	Rear window wiper.
16	20 A	Sun shade.
17	15 A	Steering column lock.
19	10 A	Left-hand door unlock.
20	20 A	Auxiliary power point.
21	20 A	Rear auxiliary power points.
22	5 A	USB port.
25	20 A	Dosing control unit - diesel.
26	20 A	Dosing control unit - diesel.
27	15 A	Dosing control unit - diesel.
28	15 A	Transmission control module - diesel.
29	50 A	Glow plugs - diesel.
31	20 A	Right-hand low beam.
32	10 A	Stoplamp switch.
33	30 A	Driver power seat.
34	40 A	Direct current/alternating current inverter.
35	50 A	Glow plugs - diesel.
37	10 A	Modified vehicle connection.
38	10 A	Data link connector.
39	20 A	Fuel-operated parking heater.
40	40 A	Rear blower motor.
41	60 A	Anti-lock brake system. Electronic stability control.
42	40 A	Modified vehicle connection.
43	15 A	Status lamp - taxi.
44	5 A	Headlamps.
45	30 A	Right-hand rear door module.

## Fuses

Fuse Location	Fuse Rating	Protected Component
46	40 A	Body control module.
47	40 A	Trailer tow module.
48	20 A	Heated seats.
49	20 A	Left-hand low beam.
50	5 A	Sun shade.
51	30 A	Anti-lock brake system. Electronic stability control.
52	40 A	Right-hand heated windshield element.
53	10 A	Air conditioning clutch.
55	5 A	Transmission control module.
56	5 A	Anti-lock brake system. Electronic stability control.
57	10 A	Modified vehicle connection.
58	10 A	Powertrain control module.
60	20 A	Modified vehicle connection.
61	15 A	Blind spot information system. Front parking aid camera. Rear view camera.
62	20 A	Body control module.
63	10 A	Modified vehicle connection.
64	5 A	Headlamp leveling.
65	5 A	Electronic power assist steering.
66	5 A	Dosing control unit - diesel. Glow plugs - diesel. Powertrain control module - diesel.
67	20 A	Powertrain control module.
68	20 A	Powertrain control module.
69	15 A	Powertrain control module.
70	20 A	Powertrain control module.

# Fuses

Fuse Location	Fuse Rating	Protected Component
73	5 A	Mass air flow and intake air temperature sensor.
79	10 A	Heated exterior mirrors.
80	5 A	Modified vehicle connection.
81	20 A	Horn.
82	40 A	Left-hand heated windshield element.
83	5 A	Windshield heated washer jets.
84	60 A	Cooling fan.
85	30 A	Fuel pump.
86	20 A	Starter motor.
87	60 A	Glow plug module - diesel.
89	40 A	Blower motor.
90	25 A	Heated rear window.

## Passenger Compartment Fuse Box

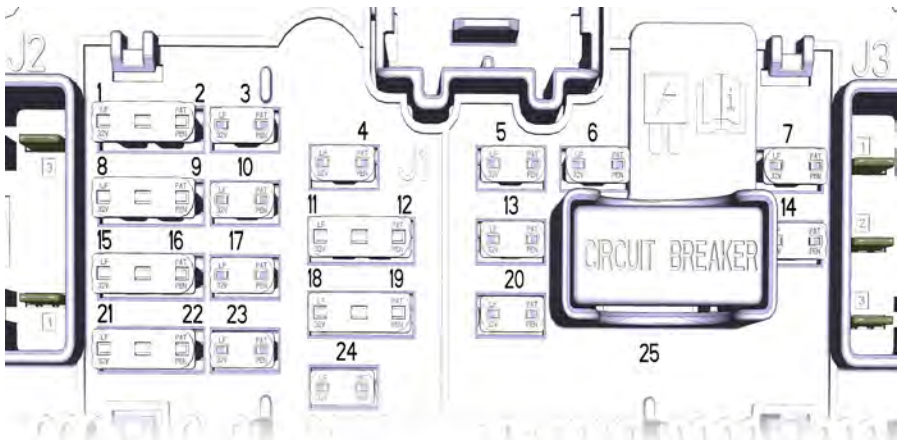

E249945

# Fuses

<b>Fuse Location</b>	<b>Fuse Rating</b>	<b>Protected Component</b>
1	5 A	Restraints control module.
2	5 A	In-vehicle temperature and humidity sensor. Rear blower motor.
3	10 A	Parking assist control module.
4	10 A	Ignition switch. Push button ignition switch.
5	20 A	Central locking system.
6	10 A	Direct current inverter. Driver door lock. Power exterior mirror switch.
7	30 A	Driver door control.
9	5 A	Auto-dimming interior mirror. Front parking aid camera. Passenger airbag deactivation indicator.
10	10 A	Restraints control module.
11	5 A	Telematics control unit module.
12	5 A	Anti-theft alarm.
13	15 A	Unlock.
14	30 A	Passenger door control.
15	10 A	Battery energy control module.
17	15 A	Voice control. Information and entertainment display. Compact disc player.
18	7.5 A	Wireless accessory charging module.
19	7.5 A	Battery back-up sounder.
20	10 A	Security horn.
21	7.5 A	Climate control.
22	7.5 A	Data link connector.

# Fuses

Fuse Location	Fuse Rating	Protected Component
		Instrument cluster.
23	20 A	Audio unit.
25	30 A	Power windows.

## CHANGING A FUSE

### General Information



**WARNING:** Always replace a fuse with one that has the specified amperage rating. Using a fuse with a higher amperage rating can cause severe wire damage and could start a fire.

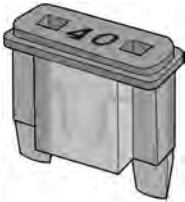

E217331

If electrical components in the vehicle are not working, a fuse may have blown. Blown fuses are identified by a broken wire within the fuse.

### Passenger Compartment Fuse Box

1. Fold back the carpet under the glove compartment.
2. Carefully remove the cover.

### Fuse Types

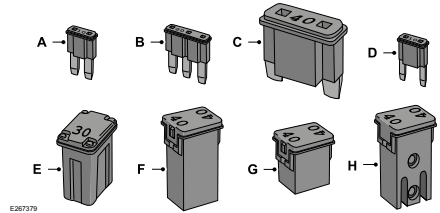

E267379

- A Micro 2.
- B Micro 3.
- C Maxi.
- D Mini.
- E M Case.
- F J Case.
- G J Case Low Profile.
- H Slotted M Case.



# Maintenance

## GENERAL INFORMATION

Have your vehicle serviced regularly to help maintain its roadworthiness and resale value. There is a large network of authorized dealers that are there to help you with their professional servicing expertise. We believe that their specially trained technicians are best qualified to service your vehicle properly and expertly. They are supported by a wide range of highly specialized tools developed specifically for servicing your vehicle.

If your vehicle requires professional service, an authorized dealer can provide the necessary parts and service. Check your warranty information to find out which parts and services are covered.

Use only recommended fuels, lubricants, fluids and service parts conforming to specifications. Motorcraft® parts are designed and built to provide the best performance in your vehicle.

### Precautions

- Do not work on a hot engine.
- Make sure that nothing gets caught in moving parts.
- Do not work on a vehicle with the engine running in an enclosed space, unless you are sure you have enough ventilation.
- Keep all open flames and other burning material (such as cigarettes) away from the battery and all fuel related parts.

### Working with the Engine Off

1. Set the parking brake and shift the transmission to park (P).
2. Switch off the engine.
3. Block the wheels.

### Working with the Engine On



**WARNING:** To reduce the risk of vehicle damage and personal burn injuries, do not start your engine with the air cleaner removed and do not remove it while the engine is running.

1. Set the parking brake and shift the transmission to park (P).
2. Block the wheels.

## OPENING AND CLOSING THE HOOD

### Opening the Hood

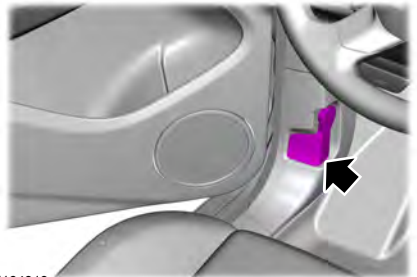

E164919

1. Open the front door.
2. Pull the hood release handle.

# Maintenance

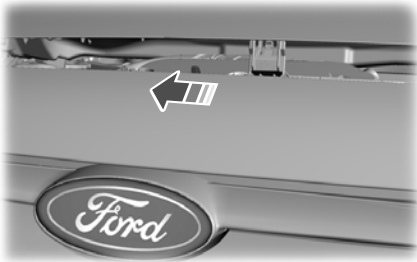

E164920

3. Move the catch to the left.



E87786

4. Open the hood and support it with the support rod.

## Closing the Hood

1. Remove the support rod from the catch and secure correctly.
2. Lower the hood and allow it to drop under its own weight for the last 8 inches to 12 inches (20 centimeters to 30 centimeters).

**Note:** *Make sure the hood is fully closed.*

## UNDER HOOD OVERVIEW - 1.5L DURATORQ-TDCI DIESEL

# Maintenance

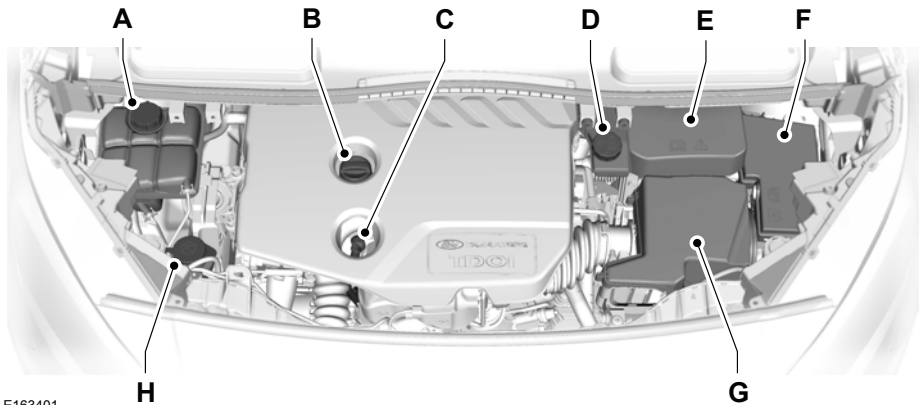

E163401

- A Engine coolant reservoir\*: See **Engine Coolant Check** (page 268).
- B Engine oil filler cap\*: See **Engine Oil Dipstick** (page 265).
- C Engine oil dipstick\*: See **Engine Oil Dipstick** (page 265).
- D Brake and clutch fluid reservoir\*: See **Brake Fluid Check** (page 272).
- E Battery: See **Changing the 12V Battery** (page 273).
- F Engine compartment fuse box: See **Fuses** (page 254).
- G Air cleaner: No maintenance necessary.
- H Windshield and rear window washer fluid reservoir: See **Washer Fluid Check** (page 273).

\* The filler caps and the engine oil dipstick are colored for easy identification.

## UNDER HOOD OVERVIEW - 2.0L DURATEC-HE (MI4)/2.0L FLEX FUEL

# Maintenance

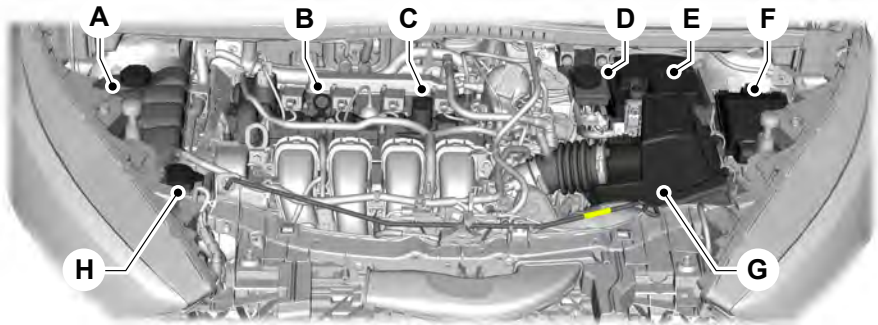

E255260

- A Engine coolant reservoir. See **Engine Coolant Check** (page 268).
- B Engine oil dipstick. See **Engine Oil Dipstick** (page 266).
- C Engine oil filler cap. See **Engine Oil Check** (page 266).
- D Brake fluid reservoir. See **Brake Fluid Check** (page 272).
- E Battery. See **Changing the 12V Battery** (page 273).
- F Engine compartment fuse box. See **Fuse Box Locations** (page 254).
- G Air filter. See **Changing the Engine Air Filter** (page 283).
- H Windshield and rear window washer reservoir. See **Washer Fluid Check** (page 273).

## UNDER HOOD OVERVIEW - 2.5L

# Maintenance

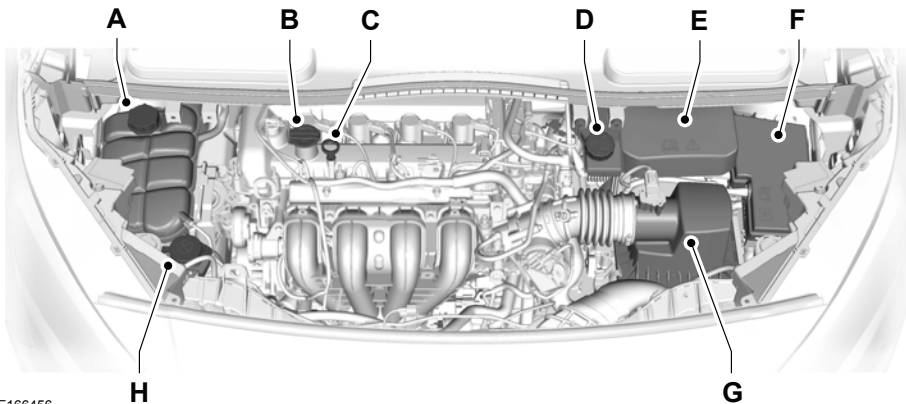

E166456

- A Engine coolant reservoir\*: See **Engine Coolant Check** (page 268).
- B Engine oil filler cap\*: See **Engine Oil Check** (page 266).
- C Engine oil dipstick\*: See **Engine Oil Check** (page 266).
- D Brake fluid reservoir\*: See **Brake Fluid Check** (page 272).
- E Battery: See **Changing the 12V Battery** (page 273).
- F Engine compartment fuse box: See **Fuses** (page 254).
- G Air cleaner: See **Changing the Engine Air Filter** (page 283).
- H Windshield and rear window washer fluid reservoir: See **Washer Fluid Check** (page 273).

## ENGINE OIL DIPSTICK - 1.5L DURATORQ-TDCI DIESEL

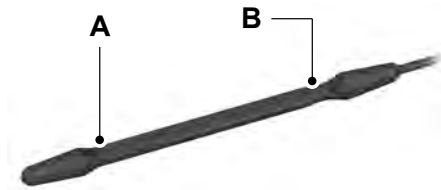

E140423

- A Minimum.
- B Maximum.

\* The filler caps and the engine oil dipstick are colored for easy identification.

# Maintenance

## ENGINE OIL DIPSTICK - 2.0L DURATEC-HE (MI4)/2.0L FLEX FUEL/2.5L

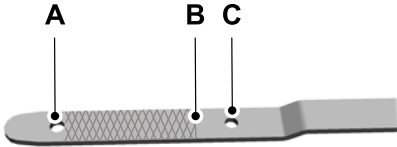

E250320

- A Minimum.
- B Nominal.
- C Maximum.

## ENGINE OIL CHECK



**WARNING:** Do not work on a hot engine.

To check the engine oil level consistently and accurately, do the following:

1. Make sure the parking brake is on. Make sure the transmission is in park (P) or neutral (N).
2. Run the engine until it reaches normal operating temperature.
3. Make sure that your vehicle is on level ground.
4. Switch the engine off and wait 15 minutes for the oil to drain into the oil pan. Checking the engine oil level too soon after you switch the engine off may result in an inaccurate reading.

5. Open the hood. See **Opening and Closing the Hood** (page 261).
6. Remove the dipstick and wipe it with a clean, lint-free cloth. See **Under Hood Overview** (page 262).
7. Replace the dipstick and remove it again to check the oil level.
8. Make sure that the oil level is between the maximum and minimum marks. If the oil level is at the minimum mark, add oil immediately.
9. If the oil level is correct, replace the dipstick and make sure it is fully seated.

**Note:** Do not remove the dipstick when the engine is running.

**Note:** If the oil level is between the maximum and minimum marks, the oil level is acceptable. Do not add oil.

**Note:** The oil consumption of new engines reaches its normal level after approximately 3,000 mi (5,000 km).

## Adding Engine Oil



**WARNING:** Do not add engine oil when the engine is hot. Failure to follow this instruction could result in personal injury.



**WARNING:** Do not remove the filler cap when the engine is running.

Do not use supplemental engine oil additives because they are unnecessary and could lead to engine damage that may not be covered by the vehicle Warranty.

# Maintenance



E142732

Only use oils certified for gasoline engines by the American Petroleum Institute (API). An oil with this trademark symbol conforms to the current engine and emission system protection standards and fuel economy requirements of the International Lubricants Specification Advisory Committee (ILSAC).

To top up the engine oil level do the following:

1. Clean the area surrounding the engine oil filler cap before you remove it.
2. Remove the engine oil filler cap. See **Under Hood Overview** (page 262). Turn it counterclockwise and remove it.
3. Add engine oil that meets Ford specifications. See **Capacities and Specifications** (page 340). You may have to use a funnel to pour the engine oil into the opening.
4. Recheck the oil level.
5. If the oil level is correct, replace the dipstick and make sure it is fully seated.
6. Replace the engine oil filler cap. Turn it clockwise until you feel a strong resistance.

**Note:** Do not add oil further than the maximum mark. Oil levels above the maximum mark may cause engine damage.

**Note:** Make sure you install the oil filler cap correctly.

**Note:** Soak up any spillage with an absorbent cloth immediately.

## OIL CHANGE INDICATOR RESET

Only reset the system after changing the engine oil and oil filter.

### Resetting the Oil Life Monitoring System

1. Switch the ignition on. Do not start the engine.
2. Fully press the accelerator and brake pedals at the same time.
3. Keep the accelerator and brake pedals fully pressed.
4. After three seconds, a message appears confirming that the reset is in progress.
5. After 25 seconds, a message appears confirming that the reset is complete.
6. Release the accelerator and brake pedals.
7. Switch the ignition off.

## ENGINE COOLING FAN - GASOLINE



**WARNING:** Keep your hands and clothing clear of the engine cooling fan.

Under certain conditions, the engine cooling fan may continue to run for several minutes after you switch your vehicle off.

# Maintenance

## ENGINE COOLING FAN - DIESEL



**WARNING:** Keep your hands and clothing clear of the engine cooling fan.

Under certain conditions, the engine cooling fan may continue to run for several minutes after you switch your vehicle off. This could happen in low ambient temperatures and independent of the engine coolant temperature, for example short journeys or low coolant temperature. See **Diesel Particulate Filter** (page 163).

## ENGINE COOLANT CHECK



**WARNING:** Do not remove the coolant reservoir cap when the cooling system is hot. Wait 10 minutes for the cooling system to cool down. Cover the coolant reservoir cap with a thick cloth to prevent the possibility of scalding and slowly remove the cap. Failure to follow this instruction could result in personal injury.



**WARNING:** Do not put coolant in the windshield washer reservoir. If sprayed on the windshield, coolant could make it difficult to see through the windshield.



**WARNING:** To reduce the risk of personal injury, make sure the engine is cool before unscrewing the coolant pressure relief cap. The cooling system is under pressure. Steam and hot liquid can come out forcefully when you loosen the cap slightly.



**WARNING:** Do not add coolant further than the **MAX** mark.

When the engine is cold, check the concentration and level of the coolant at the intervals listed in the scheduled maintenance information. See **Scheduled Maintenance** (page 416).

**Note:** Make sure that the coolant level is between the **MIN** and **MAX** marks on the coolant reservoir.

**Note:** Coolant expands when it is hot. The level may extend beyond the **MAX** mark.

Maintain coolant concentration within 48% to 50%, which equates to a freeze point between -29°F (-34°C) and -35°F (-37°C). Coolant concentration should be checked using a refractometer. We do not recommend the use of hydrometers or coolant test strips for measuring coolant concentration.

## Adding Coolant



**WARNING:** Do not add engine coolant when the engine is hot. Failure to follow this instruction could result in personal injury.



**WARNING:** Do not remove the coolant reservoir cap when the cooling system is hot. Wait 10 minutes for the cooling system to cool down. Cover the coolant reservoir cap with a thick cloth to prevent the possibility of scalding and slowly remove the cap. Failure to follow this instruction could result in personal injury.

**Note:** Automotive fluids are not interchangeable. Take care not to put engine coolant in the windshield washer fluid reservoir or windshield washer fluid in the engine coolant reservoir.



# Maintenance

---

**Note:** Do not use stop leak pellets, cooling system sealants, or non-specified additives as they can cause damage to the engine cooling or heating systems. Resulting component damage may not be covered by the vehicle Warranty.

It is very important to use prediluted coolant approved to the correct specification in order to avoid plugging the small passageways in the engine cooling system. Do not mix different colors or types of coolant in your vehicle. Mixing of engine coolants or using an incorrect coolant may harm the engine or cooling system components and may not be covered by the vehicle Warranty.

**Note:** If prediluted coolant is not available, use the approved concentrated coolant diluting it to 50/50 with distilled water. Using water that has not been deionised may contribute to deposit formation, corrosion and plugging of the small cooling system passageways.

**Note:** Coolants marketed for all makes and models may not be approved to our specifications and may cause damage to the cooling system. Resulting component damage may not be covered by the vehicle Warranty.

If the coolant level is at or below the minimum mark, add prediluted coolant immediately.

To top up the coolant level do the following:

1. Unscrew the cap slowly. Any pressure escapes as you unscrew the cap.
2. Add prediluted coolant approved to the correct specification.
3. Add enough prediluted coolant to reach the correct level.
4. Replace the coolant reservoir cap, turn it clockwise until you feel a strong resistance.

5. Check the coolant level in the coolant reservoir the next few times you drive your vehicle. If necessary, add enough prediluted engine coolant to bring the coolant level to the correct level.

If you have to add more than 1.1 qt (1 L) of engine coolant per month, have your vehicle checked as soon as possible. Operating an engine with a low level of coolant can result in engine overheating and possible engine damage.

**Note:** During normal vehicle operation, the coolant may change color from orange to pink or light red. As long as the coolant is clear and uncontaminated, this color change does not indicate the coolant has degraded nor does it require the coolant to be drained, the system to be flushed, or the coolant to be replaced.

In case of emergency, you can add a large amount of water without engine coolant in order to reach a vehicle service location. In this instance, qualified personnel:

1. Must drain the cooling system.
2. Chemically clean the coolant system.
3. Refill with engine coolant as soon as possible.

Water alone, without engine coolant, can cause engine damage from corrosion, overheating or freezing.

Do not use the following as a coolant substitute:

- Alcohol.
- Methanol.
- Brine.
- Any coolant mixed with alcohol or methanol antifreeze.

Alcohol and other liquids can cause engine damage from overheating or freezing.

# Maintenance

Do not add extra inhibitors or additives to the coolant. These can be harmful and compromise the corrosion protection of the coolant.

## Recycled Coolant

We do not recommend the use of recycled coolant as an approved recycling process is not yet available.

Dispose of used engine coolant in an appropriate manner. Follow your community's regulations and standards for recycling and disposing of automotive fluids.

## Severe Climates

If you drive in extremely cold climates:

- It may be necessary to increase the coolant concentration above 50%.
- A coolant concentration of 60% provides improved freeze point protection. Coolant concentrations above 60% decrease the overheat protection characteristics of the coolant and may cause engine damage.

If you drive in extremely hot climates:

- You can decrease the coolant concentration to 40%.
- Coolant concentrations below 40% decrease the freeze and corrosion protection characteristics of the coolant and may cause engine damage.

Vehicles driven year-round in non-extreme climates should use prediluted coolant for optimum cooling system and engine protection.

## Coolant Change

At specific mileage intervals, as listed in the scheduled maintenance information, the coolant should be changed. Add prediluted coolant approved to the correct specification.

## Fail-Safe Cooling

Fail-safe cooling allows you to temporarily drive your vehicle before any incremental component damage occurs. The fail-safe distance depends on ambient temperature, vehicle load and terrain.

### How Fail-Safe Cooling Works



If the engine begins to overheat, the coolant temperature gauge moves toward the red zone:



A warning lamp illuminates and a message may appear in the information display.

If the engine reaches a preset over-temperature condition, the engine automatically switches to alternating cylinder operation. Each disabled cylinder acts as an air pump and cools the engine.

When this occurs, your vehicle still operates, however:

- Engine power is limited.
- The air conditioning system turns off.

Continued operation increases the engine temperature, causing the engine to completely shut down. Your steering and braking effort increases in this situation.

When the engine temperature cools, you can re-start the engine. Have your vehicle checked as soon as possible to minimize engine damage.

# Maintenance

## When Fail-Safe Mode Is Activated



**WARNING:** Fail-safe mode is for use during emergencies only. Operate your vehicle in fail-safe mode only as long as necessary to bring your vehicle to rest in a safe location and seek immediate repairs. When in fail-safe mode, your vehicle will have limited power, will not be able to maintain high-speed operation, and may completely shut down without warning, potentially losing engine power, power steering assist, and power brake assist, which may increase the possibility of a crash resulting in serious injury.



**WARNING:** Do not remove the coolant reservoir cap when the cooling system is hot. Wait 10 minutes for the cooling system to cool down. Cover the coolant reservoir cap with a thick cloth to prevent the possibility of scalding and slowly remove the cap. Failure to follow this instruction could result in personal injury.

Your vehicle has limited engine power when in the fail-safe mode, drive your vehicle with caution. Your vehicle does not maintain high-speed operation and the engine may operate poorly.

Remember that the engine is capable of automatically shutting down to prevent engine damage. In this situation:

1. Pull off the road as soon as safely possible and switch the engine off.
2. If you are a member of a roadside assistance program, we recommend that you contact your roadside assistance service provider.
3. If this is not possible, wait a short period for the engine to cool.

4. Check the coolant level. If the coolant level is at or below the minimum mark, add prediluted coolant immediately.
5. When the engine temperature cools, you can re-start the engine. Have your vehicle checked as soon as possible to minimize engine damage.

**Note:** *Driving your vehicle without repair increases the chance of engine damage.*

## Engine Coolant Temperature Management (If Equipped)



**WARNING:** To reduce the risk of crash and injury, be prepared that the vehicle speed may reduce and the vehicle may not be able to accelerate with full power until the coolant temperature reduces.

If you tow a trailer with your vehicle, the engine may temporarily reach a higher temperature during severe operating conditions, for example ascending a long or steep grade in high ambient temperatures.

At this time, you may notice the coolant temperature gauge moves toward the red zone and a message may appear in the information display.

You may notice a reduction in vehicle speed caused by reduced engine power in order to manage the engine coolant temperature. Your vehicle may enter this mode if certain high-temperature and high-load conditions take place. The amount of speed reduction depends on vehicle loading, grade and ambient temperature. If this occurs, there is no need to stop your vehicle. You can continue to drive.

# Maintenance

The air conditioning may automatically turn on and off during severe operating conditions to protect the engine from overheating. When the coolant temperature decreases to the normal operating temperature, the air conditioning turns on.

If the coolant temperature gauge moves fully into the red zone, or if the coolant temperature warning or service engine soon messages appear in your information display, do the following:

1. Stop your vehicle as soon as it is safe to do so. Fully apply the parking brake, shift into park (P) or neutral (N).
2. Leave the engine running until the coolant temperature gauge needle returns to the normal position. After several minutes, if the temperature does not drop, follow the remaining steps.
3. Switch the engine off and wait for it to cool. Check the coolant level.
4. If the coolant level is at or below the minimum mark, add prediluted coolant immediately.
5. If the coolant level is normal, restart the engine and continue.

## AUTOMATIC TRANSMISSION FLUID CHECK

The automatic transmission does not have a transmission fluid dipstick.

Have an authorized dealer check and change the transmission fluid at the correct service interval. See **Scheduled Maintenance** (page 416). Your transmission does not consume fluid. However, if the transmission slips, shifts slowly or if you notice a sign of leaking fluid, contact an authorized dealer.

Do not use supplemental transmission fluid additives, treatments or cleaning agents. The use of these materials may affect transmission operation and result in damage to internal transmission components.

## BRAKE FLUID CHECK



**WARNING:** Do not use any fluid other than the recommended brake fluid as this will reduce brake efficiency. Use of incorrect fluid could result in the loss of vehicle control, serious personal injury or death.



**WARNING:** Only use brake fluid from a sealed container. Contamination with dirt, water, petroleum products or other materials may result in brake system damage or failure. Failure to adhere to this warning could result in the loss of vehicle control, serious personal injury or death.



**WARNING:** Do not allow the fluid to touch your skin or eyes. If this happens, rinse the affected areas immediately with plenty of water and contact your physician.



**WARNING:** A fluid level between the **MAX** and **MIN** lines is within the normal operating range and there is no need to add fluid. A fluid level not in the normal operating range could compromise the performance of the system. Have your vehicle checked immediately.

# Maintenance



E170684

To avoid fluid contamination, the reservoir cap must remain in place and fully tight, unless you are adding fluid.

Only use fluid that meets Ford specifications.

## WASHER FLUID CHECK

When adding fluid, use a mixture of washer fluid and water to help prevent freezing in cold weather and improve the cleaning capability. For information on fluid dilution, refer to the product instructions. We recommend that you only use high quality washer fluid.

**Note:** *The reservoir supplies the front and rear washer systems.*

## CHANGING THE 12V BATTERY

 **WARNING:** Batteries normally produce explosive gases which can cause personal injury. Therefore, do not allow flames, sparks or lighted substances to come near the battery. When working near the battery, always shield your face and protect your eyes. Always provide correct ventilation.

 **WARNING:** When lifting a plastic-cased battery, excessive pressure on the end walls could cause acid to flow through the vent caps, resulting in personal injury and damage to the vehicle or battery. Lift the battery with a battery carrier or with your hands on opposite corners.

 **WARNING:** Keep batteries out of reach of children. Batteries contain sulfuric acid. Avoid contact with skin, eyes or clothing. Shield your eyes when working near the battery to protect against possible splashing of acid solution. In case of acid contact with skin or eyes, flush immediately with water for a minimum of 15 minutes and get prompt medical attention. If acid is swallowed, call a physician immediately.

 **WARNING:** Battery posts, terminals and related accessories contain lead and lead compounds, chemicals known to the State of California to cause cancer and reproductive harm. **Wash your hands after handling.**

Your vehicle has a Motorcraft® maintenance-free battery which normally does not require additional water during its life of service.

**Note:** *If your vehicle's battery has a cover or shield, make sure it is reinstalled after the battery has been cleaned or replaced.*

# Maintenance

**Note:** See an authorized dealer for low voltage battery access, testing, or replacement.

When a low voltage battery replacement is necessary, see an authorized dealer to replace the low voltage battery with a Ford recommended replacement low voltage battery that matches the electrical requirements of the vehicle.

To ensure proper operation of the battery management system (BMS), do not allow a technician to connect any electrical device ground connection directly to the low voltage battery negative post. A connection at the low voltage battery negative post can cause inaccurate measurements of the battery condition and potential incorrect system operation.

**Note:** If a person adds electrical or electronic accessories or components to the vehicle, the accessories or components may adversely affect the low voltage battery performance and durability and may also affect the performance of other electrical systems in the vehicle.

For longer, trouble-free operation, keep the top of the battery clean and dry. Also, make certain the battery cables are always tightly fastened to the battery terminals.

If you see any corrosion on the battery or terminals, remove the cables from the terminals and clean with a wire brush. You can neutralize the acid with a solution of baking soda and water.

When a battery replacement is required, the battery should only be replaced with a Ford recommended replacement battery that matches the electrical requirements of the vehicle.

Because your vehicle's engine is electronically-controlled by a computer, some engine control settings are maintained by power from the low voltage battery. Some engine computer settings, like the idle trim and fuel trim strategy,

optimize the driveability and performance of the engine. Some other computer settings, like the clock and radio station presets, are also maintained in memory by power from the low voltage battery. When a technician disconnects and connects the low voltage battery, these settings are erased. Complete the following procedure in order to restore the settings:

1. With the vehicle at a complete stop, set the parking brake.
2. Shift the transmission into park (P).
3. Switch off all accessories.
4. Fully press the brake pedal and start the vehicle.
5. Run the engine until it reaches normal operating temperature. While the engine is warming up, complete the following: Reset the clock. See **Audio System** (page 352). Reset the power windows bounce-back feature. See **Windows and Mirrors** (page 83). Reset the radio station presets. See **Audio System** (page 352).
6. Allow the engine to idle for at least one minute. If the engine turns off, press the accelerator pedal to start the engine.
7. While the engine is running, press the brake pedal and shift into neutral (N).
8. Allow the engine to run for at least one minute by pressing on the accelerator pedal.
9. Drive the vehicle at least 12 mi (20 km) to completely relearn the idle and fuel trim strategy.

**Note:** If you do not allow the engine to relearn the idle and fuel trim strategy, the idle quality of your vehicle may be adversely affected until the engine computer eventually relearns the idle trim and fuel trim strategy.

# Maintenance

Make sure that you dispose of old batteries in an environmentally friendly way. Seek advice from your local authority about recycling old batteries.

## CHECKING THE WIPER BLADES



E142463

Run the tip of your fingers over the edge of the blade to check for roughness.

Clean the wiper blades with washer fluid or water applied with a soft sponge or cloth.

## CHANGING THE FRONT WIPER BLADES

1. Switch the ignition off.



E162532

2. Manually move the wiper arms to the service position. The windshield wipers return to the starting position when you switch the ignition on.

**Note:** Do not hold the wiper blade when moving the wiper arm to the service position.

**Note:** You cannot manually move the wiper arms to the service position when you switch the ignition on.

**Note:** You can use the service position to provide easier access to the wiper blades for freeing them from snow and ice.

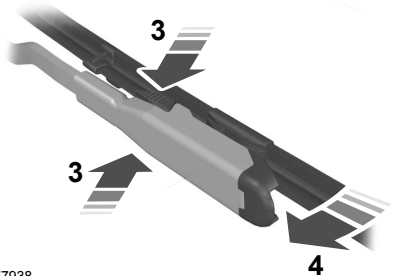

E257938

3. Lift the wiper arm and then press the wiper blade locking buttons together.

**Note:** Do not hold the wiper blade when lifting the wiper arm.

4. Slightly rotate the wiper blade.
5. Remove the wiper blade.

**Note:** Make sure that the wiper arm does not spring back against the glass when the wiper blade is not attached.

6. To install, reverse the removal procedure.

**Note:** Make sure that the wiper blade locks into place.

## CHANGING THE REAR WIPER BLADES - VEHICLES WITH: MANUAL LIFTGATE

1. Lift the wiper arm.

**Note:** Do not hold the wiper blade when lifting the wiper arm.

# Maintenance

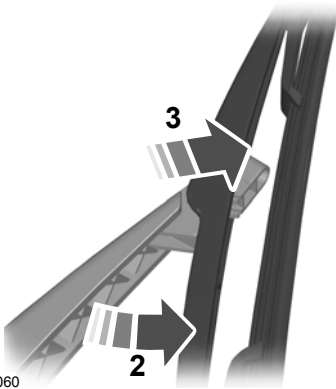

2. Slightly rotate the wiper blade.
3. Remove the wiper blade.

**Note:** Make sure that the wiper arm does not spring back against the glass when the wiper blade is not attached.

4. To install, reverse the removal procedure.

**Note:** Make sure that the wiper blade locks into place.

## CHANGING THE REAR WIPER BLADES - VEHICLES WITH: REAR CARGO DOORS

1. Lift the wiper arm.

**Note:** Do not hold the wiper blade to lift the wiper arm.

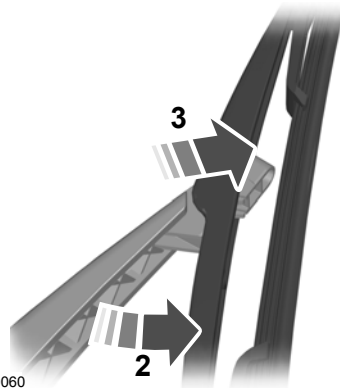

2. Slightly rotate the wiper blade.
3. Remove the wiper blade.

**Note:** Make sure that the wiper arm does not spring back against the glass when the wiper blade is not attached.

4. To install, reverse the removal procedure.

**Note:** Make sure that the wiper blade locks into place.

## ADJUSTING THE HEADLAMPS

### Vertical Aim Adjustment

If your vehicle has been involved in a crash, have the aim of the headlamp beam checked by an authorized dealer.



# Maintenance

## Headlamp Aiming Target

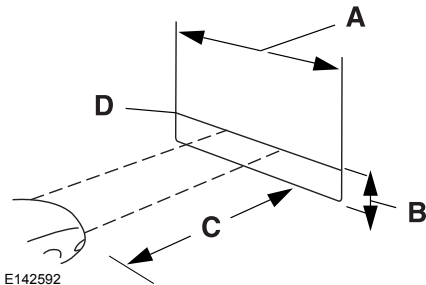

- A 8 ft (2.4 m)
- B Ground to the center of the headlamp low beam bulb
- C 25 ft (7.6 m)
- D Horizontal reference line

## Vertical Aim Adjustment Procedure

1. Park your vehicle on level ground approximately 25 ft (7.6 m) from a wall or screen.
2. Measure the distance from the ground to the center of the headlamp low beam bulb and mark an 8 ft (2.4 m) long horizontal reference line on the wall or screen at this height.

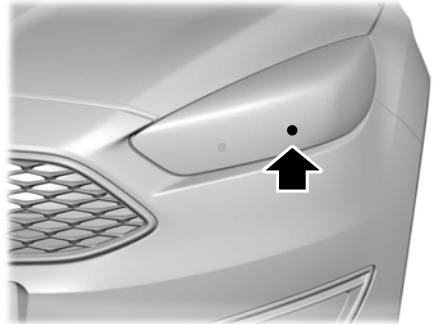

**Note:** There may be an identifying mark on the lens to help you locate the center of the bulb.

**Note:** To see a clearer light pattern while adjusting one headlamp, you may want to block the light from the other headlamp.

3. Switch on the low beam headlamps and open the hood.



4. On the wall or screen you will observe a flat zone of high intensity light located at the top of the beam pattern. If the top edge of the flat zone of high intensity light is not on the horizontal reference line, adjust the aim of the headlamp beam.

# Maintenance

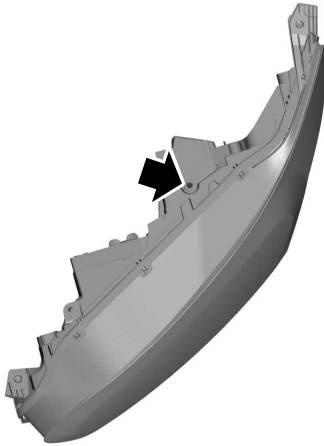

E164485

5. Locate the vertical adjuster on each headlamp. Use a suitable tool, for example a screwdriver or hexagonal socket, to turn the adjuster clockwise or counterclockwise to adjust the vertical aim of the headlamp. The horizontal edge of the brighter light should touch the horizontal reference line.
6. Close the hood and switch off the lamps.

## Horizontal Aim Adjustment

The horizontal aim of the headlamp beam on your vehicle is not adjustable.

## CHANGING A BULB

**WARNING:** Switch the lamps and the ignition off. Failure to do so could result in serious personal injury.



**WARNING:** Bulbs can become hot, let the bulb cool down before removing it. Failure to do so could result in personal injury.

The following instructions describe how to remove the bulbs. Fit replacements in the reverse order unless otherwise stated.

You must fit bulbs of the correct specification. See **Bulb Specification Chart** (page 350).

**Note:** We recommended that you see an authorized dealer to change the headlamp bulbs if your vehicle is fitted with air conditioning. Some bulbs are difficult to access.

## Headlamp

Remove the covers to gain access to the bulbs.

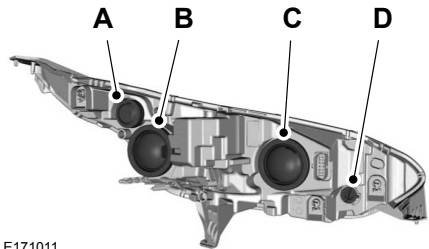

E171011

- A Side marker
- B Headlamp low beam and side lamp
- C Headlamp high beam
- D Direction indicator

# Maintenance

## Side Marker

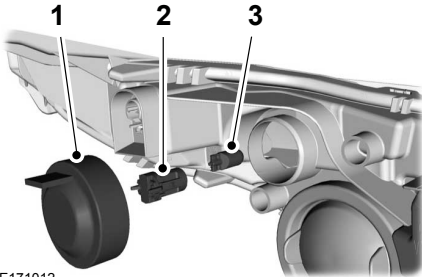

E171012

1. Remove the cover.
2. Remove the bulb holder by pulling it straight out.
3. Remove the bulb from the bulb holder by pulling it straight out.

## Side Lamp

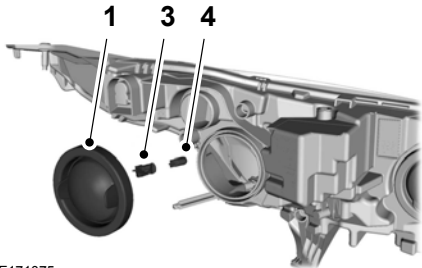

E171015

1. Remove the cover.
2. Remove headlamp low beam bulb.
3. Remove the side lamp bulb holder by pulling it straight out.
4. Remove the bulb from the bulb holder by pulling it straight out.

## Direction Indicator

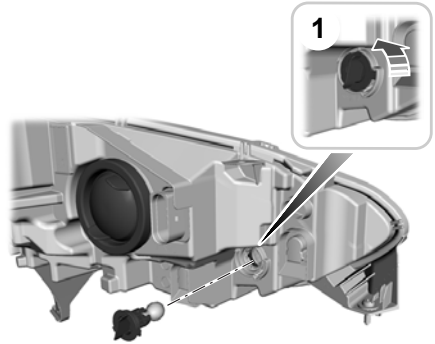

E165475

1. Turn the bulb holder counterclockwise and remove it.

**Note:** You cannot separate the bulb from the bulb holder.

## Headlamp Low Beam

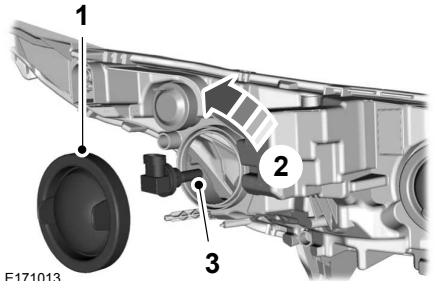

E171013

1. Remove the cover.
2. Turn the bulb holder counterclockwise and remove it.
3. Remove the bulb by pulling it straight out.

**Note:** Do not touch the glass of the bulb.

# Maintenance

## Headlamp High Beam

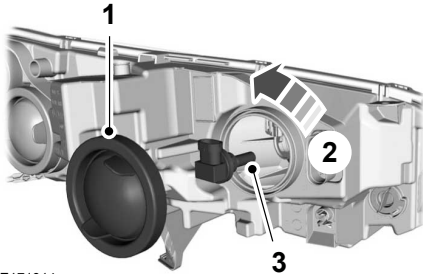

E171014

1. Remove the cover.
2. Turn the bulb holder counterclockwise and remove it.

**Note:** Do not touch the glass of the bulb.

## Side Direction Indicator

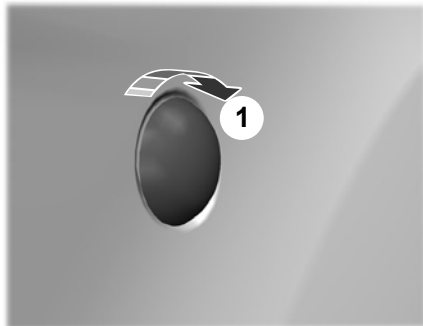

E165495

1. Turn the lamp clockwise and remove it.

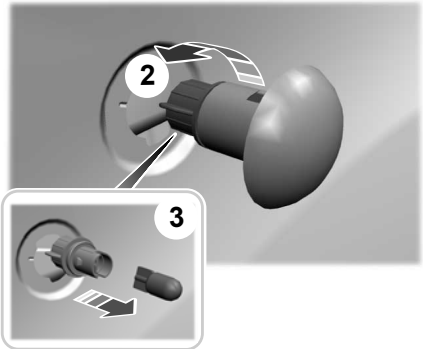

E165496

2. Hold the bulb holder and turn the lamp counterclockwise and remove it.
3. Remove the bulb by pulling it straight out.

## Front Fog Lamps

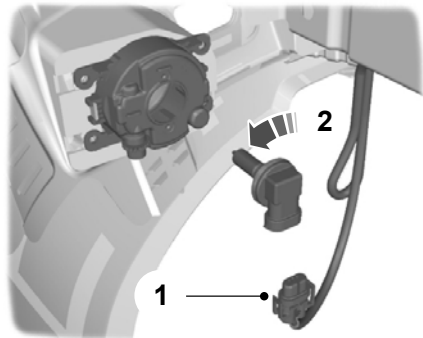

E71062

1. Disconnect the electrical connector.
2. Turn the bulb holder counterclockwise and remove it.

**Note:** Do not touch the glass of the bulb.

**Note:** You cannot separate the bulb from the bulb holder.

# Maintenance

## Rear Lamps

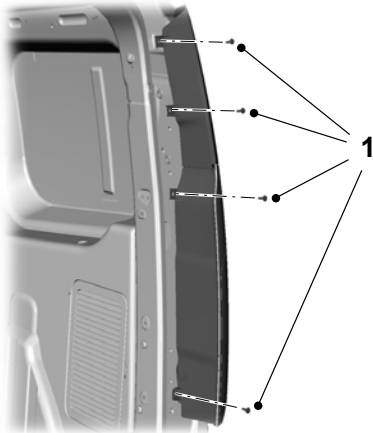

E165484

1. Remove the screws.

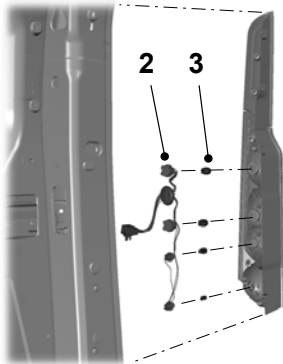

E165485

2. Turn the bulb holders counterclockwise to remove them.
3. Remove the bulbs by pulling them straight out.

## Central High Mounted Brake Lamp

These are not serviceable items, see an authorized dealer if they fail.

## License Plate Lamp

These are not serviceable items, see an authorized dealer if they fail.

## Interior Lamps

### Front Interior Lamp

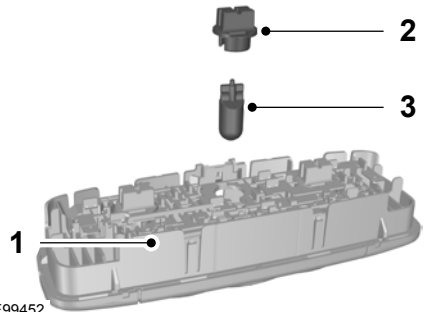

E99452

1. Carefully remove the lamp.
2. Turn the bulb holder counterclockwise and remove it.



E73939

3. Remove the bulb by pulling it straight out.

# Maintenance

## Front Interior LED Lamps

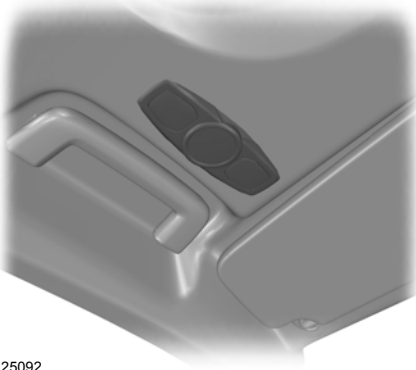

E125092

**Note:** If your vehicle has LED lamps these are not serviceable items, see an authorized dealer if they fail.

## Reading Lamps

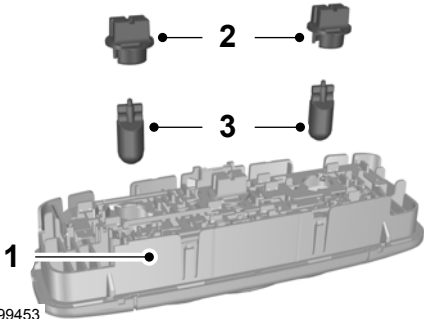

E99453

1. Carefully remove the lamp.
2. Turn the bulb holder counterclockwise and remove it.
3. Remove the bulb by pulling it straight out.

## Cargo Area Lamp

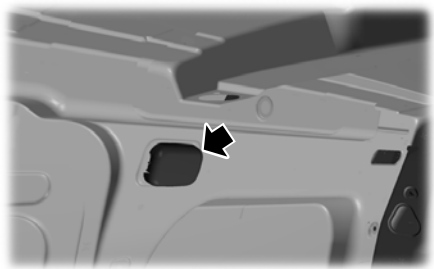

E163429

1. Pry off the lamp cover.

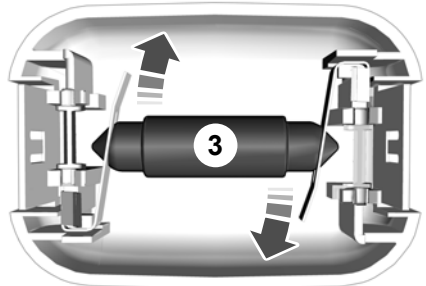
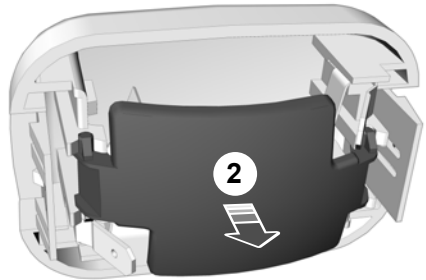

E166153

2. Remove the cover.
3. Remove the bulb.

# Maintenance

## CHANGING THE ENGINE AIR FILTER - 2.0L DURATEC-HE (MI4)/2.0L FLEX FUEL, 1.5L DURATORQ-TDCI DIESEL



**WARNING:** To reduce the risk of vehicle damage and personal burn injuries, do not start your engine with the air cleaner removed and do not remove it while the engine is running.

Change the air filter element at the correct service interval. See **Scheduled Maintenance** (page 416).

Use the correct specification air filter element. See **Motorcraft Parts** (page 330).

**Note:** Failure to use the correct air filter element may result in severe engine damage. Resulting component damage may not be covered by the vehicle Warranty.

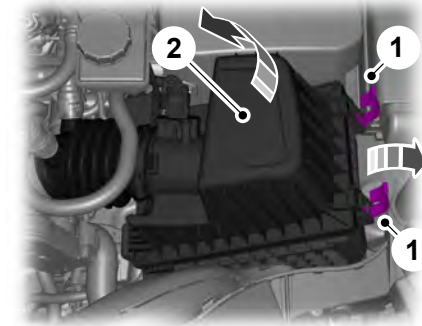

E269615

1. Release the clamps that secure the air filter cover to the housing.
2. Carefully lift the air filter housing cover.
3. Remove the air filter element from the air filter housing.

4. Wipe any dirt or debris from the air filter housing and cover to make sure no dirt gets in the engine and that you have a good seal.
5. Install a new air filter element. Be careful not to crimp the filter element edges between the air filter housing and cover.
6. Install the air filter housing cover.
7. Install the screws to secure the air filter housing cover to the air filter housing.

## CHANGING THE ENGINE AIR FILTER - 2.5L



**WARNING:** To reduce the risk of vehicle damage and personal burn injuries, do not start your engine with the air cleaner removed and do not remove it while the engine is running.

Change the air filter element at the correct service interval. See **Scheduled Maintenance** (page 416).

Use the correct specification air filter element. See **Motorcraft Parts** (page 332).

**Note:** Failure to use the correct air filter element may result in severe engine damage. Resulting component damage may not be covered by the vehicle Warranty.

# Maintenance

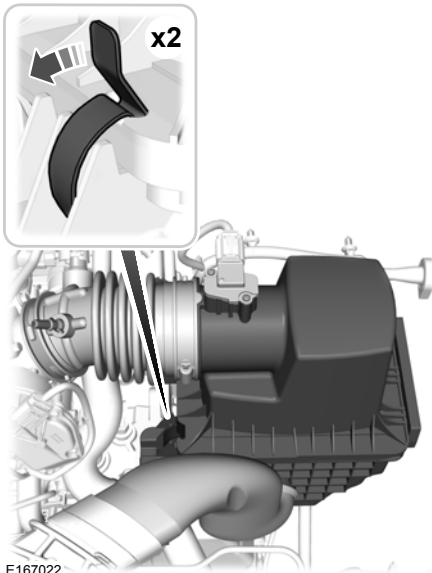

## DRIVE BELT ROUTING - 1.5L DURATORQ-TDCI DIESEL

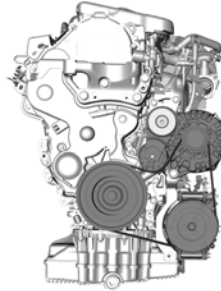

E25262

## DRIVE BELT ROUTING - 2.0L DURATEC-HE (MI4)/2.0L FLEX FUEL

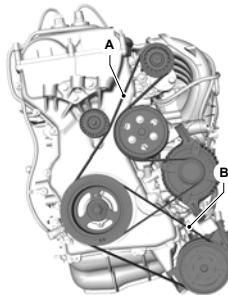

E25261

1. Release the clips that secure the air filter cover to the housing.
2. Carefully lift the air filter housing cover.
3. Remove the air filter element from the air filter housing.
4. Wipe any dirt or debris from the air filter housing and cover to make sure no dirt gets in the engine and that you have a good seal.
5. Install a new air filter element.
6. Install the air filter housing cover. Be careful not to crimp the filter element edges between the air filter housing and cover. This could cause filter damage and allow unfiltered air to enter the engine if it is not properly seated.
7. Engage the clips to secure the air filter housing cover to the air filter housing.

- A The generator and water pump drive belt is on the first pulley closest to the engine.
- B The air conditioning drive belt is on the second pulley furthest from the engine.



# Maintenance

---

## DRIVE BELT ROUTING - 2.5L

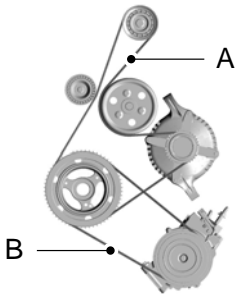

E161383

- A The generator drive belt is on the first pulley closest to the engine.
- B The air conditioning drive belt is on the second pulley furthest from the engine.

# Vehicle Care

## CLEANING PRODUCTS

For best results, use the following products or products of equivalent quality:

### Materials

Name	Specification
Motorcraft® Bug and Tar Remover (U.S.) Motorcraft® Bug and Tar Remover / Dissolvant de goudron et éliminateur d'insectes Motorcraft® (Canada) ZC-42 (U.S. & Canada)	-
Motorcraft® Custom Bright Metal Cleaner (U.S.) Motorcraft® Custom Bright Metal Cleaner / Nettoyant pour métal brillant Motorcraft® (Canada) ZC-15 (U.S. & Canada)	ESR-M5B194-B
Motorcraft® Detail Wash (U.S.) Motorcraft® Detail Wash / Shampooing superfin Motorcraft® (Canada) ZC-3-A (U.S. & Canada)	ESR-M14P4-A
Motorcraft® Engine Shampoo and Degreaser (U.S.) (Canada) ZC-20 (U.S.)	ESR-M14P3-A
(U.S.) Motorcraft® Engine Shampoo / Shampooing pour moteur Motorcraft® (Canada) CXC-66-A (Canada)	-
(U.S.) Motorcraft® Multi-Purpose Cleaner / Nettoyant multi-usage Motorcraft® (Canada) CXC-101 (Canada)	-
Motorcraft® Premium Windshield Wash Concentrate with Bitterant (U.S.) Motorcraft® Premium Quality Windshield Washer Fluid / Liquide lave-glace de haute qualité Motorcraft® (Canada) ZC-32-B2 (U.S.) CXC-37-A/B/D/F (Canada)	WSS-M14P19-A
Motorcraft® Professional Strength Carpet & Upholstery Cleaner (U.S.)	-

# Vehicle Care

Name	Specification
Motorcraft® Professional Strength Carpet & Upholstery Cleaner / Nettoyant professionnel pour sellerie et moquette Motorcraft® (Canada) ZC-54 (U.S. & Canada)	
Motorcraft® Spot and Stain Remover (U.S.) (Canada) ZC-14 (U.S.)	-
Motorcraft® Ultra-Clear Spray Glass Cleaner (U.S.) Motorcraft® Premium Glass Cleaner / Nettoie-vitres de qualité supérieure Motorcraft® (Canada) ZC-23 (U.S.) CXC-100 (Canada)	ESR-M14P5-A
Motorcraft® Wheel and Tire Cleaner (U.S.) Motorcraft® Wheel and Tire Cleaner / Nettoyant pour roues et pneus Motorcraft® (Canada) ZC-37-A (U.S. & Canada)	-

## CLEANING THE EXTERIOR

Wash your vehicle regularly with cool or lukewarm water and a neutral pH shampoo, we recommend Motorcraft Detail Wash.

- Never use strong household detergents or soap, for example dish washing or laundry liquid. These products can discolor and spot painted surfaces.
- Never wash your vehicle when it is hot to the touch, or during strong or direct sunlight.
- Dry your vehicle with a chamois or soft terry cloth towel to eliminate water spotting.
- Immediately remove fuel spillages, bird droppings, insect deposits and road tar. These may cause damage to your vehicle's paintwork or trim over time. We recommend Motorcraft Bug and Tar Remover.

- Remove any exterior accessories, for example antennas, before entering a car wash.
- When filling with AdBlue®, remove any residue on painted surfaces immediately.

**Note:** *Suntan lotions and insect repellents can damage painted surfaces. If these substances come in contact with your vehicle, wash the affected area as soon as possible.*

### Cleaning the Headlamps

**Note:** *Do not scrape the headlamp lenses or use abrasives, alcoholic solvents or chemical solvents to clean them.*

**Note:** *Do not wipe the headlamps when they are dry.*

# Vehicle Care

---

## Exterior Chrome Parts

- Apply a high quality-cleaning product to bumpers and other chrome parts. Follow the manufacturer's instructions. We recommend Motorcraft Custom Bright Metal Cleaner.
- Do not apply the cleaning product to hot surfaces. Do not leave the cleaning product on chrome surfaces longer than the time recommended.
- Using non-recommended cleaners can result in severe and permanent cosmetic damage.

**Note:** *Never use abrasive materials, for example steel wool or plastic pads as they can scratch the chrome surface.*

**Note:** *Do not use chrome cleaner, metal cleaner or polish on wheels or wheel covers.*

## Exterior Plastic Parts

For routine cleaning we recommend Motorcraft Detail Wash. If tar or grease spots are present, we recommend Motorcraft Bug and Tar Remover.

## Stripes or Graphics (If Equipped)

Hand washing your vehicle is preferred however, pressure washing may be used under the following conditions:

- Do not use water pressure higher than 2,000 psi (14,000 kPa).
- Do not use water hotter than 179°F (82°C).
- Use a spray with a 40° wide spray angle pattern.
- Keep the nozzle at a 12 in (305 mm) distance and 90° angle to your vehicle's surface.

**Note:** *Holding the pressure washer nozzle at an angle to the vehicle's surface may damage graphics and cause the edges to peel away from the vehicle's surface.*

## Underbody

Regularly clean the underside of your vehicle using water. Keep body and door drain holes free of debris or foreign material.

## Under Hood

For removing black rubber marks from under the hood we recommend Motorcraft Wheel and Tire Cleaner or Motorcraft Bug and Tar Remover.

## WAXING

Regular waxing is necessary to protect your car's paint from the elements. We recommend that you wash and wax the painted surface once or twice a year.

When washing and waxing, park your vehicle in a shaded area out of direct sunlight. Always wash your vehicle before applying wax.

- Use a quality wax that does not contain abrasives.
- Follow the manufacturer's instructions to apply and remove the wax.
- Apply a small amount of wax in a back-and-forth motion, not in circles.
- Do not allow wax to come in contact with any non-body (low-gloss black) colored trim. The wax will discolor or stain the parts over time.
  - Roof racks.
  - Bumpers.
  - Grained door handles.
  - Side moldings.
  - Mirror housings.
  - Windshield cowl area.
- Do not apply wax to glass areas.
- After waxing, your car's paint should feel smooth, and be free of streaks and smudges.

# Vehicle Care

## CLEANING THE WINDOWS AND WIPER BLADES

Car wash chemicals and environmental fallout can result in windshield and wiper blade contamination. Dirty windshield and wipers will result in poor windshield wiper operation. Keep the windshield and wiper blades clean to maintain windshield wiper performance.

To clean the windshield and wiper blades:

- Clean the windshield with a non-abrasive glass cleaner. When cleaning the interior of the windshield, avoid getting any glass cleaner on the instrument panel or door panels. Wipe any glass cleaner off these surfaces immediately.
- For windshields contaminated with tree sap, chemicals, wax or bugs, clean the entire windshield using steel wool (no greater than 0000 grade) in a circular motion and rinse with water.
- Clean the wiper blades with isopropyl rubbing alcohol or windshield washer concentrate.

**Note:** Do not use razor blades or other sharp objects to clean or remove decals from the inside of the heated rear window. The vehicle warranty does not cover damage caused to the heated rear window grid lines.

## CLEANING THE INTERIOR

**Note:** Do not allow air fresheners and hand sanitizers to spill on interior surfaces. If a spill occurs, wipe off immediately. Damage may not be covered by your warranty.

**Note:** Do not use household cleaning products or glass cleaners, which can stain and discolor the fabric and affect the flame retardant abilities of the seat materials.

**Note:** We recommend distilled water when cleaning.

## Fabric, Carpets, Cloth Seats, Headliners and Floor Mats

**Note:** Avoid soaking any surface. Do not use excessive amounts of water to clean the vehicle interior.

**Note:** To avoid spots or discoloration, clean the entire surface.

To clean:

- Remove dust and loose dirt with a vacuum cleaner or brush.
- Wipe the surface with a soft, damp cloth and a mild soap and water solution. Dry the area with a clean, soft cloth.
- If a ring forms on the fabric after spot cleaning, clean the entire area immediately, but do not soak or the ring will set.

## Seatbelts



**WARNING:** Do not use cleaning solvents, bleach or dye on the vehicle's seatbelts, as these actions may weaken the belt webbing.



**WARNING:** On vehicles equipped with seat-mounted airbags, do not use chemical solvents or strong detergents. Such products could contaminate the side airbag system and affect performance of the side airbag in a crash.

**Note:** Do not use abrasives, or chemical solvents to clean them.

**Note:** Do not allow moisture to penetrate the seatbelt retractor mechanism.

Cleaning may safely be carried out using mild soap and water. Let them dry naturally, away from artificial heat.

# Vehicle Care

## Leather Interior (If Equipped)

Follow the same procedure as cleaning leather seats for cleaning leather instrument panels and leather interior trim surfaces.

## Suede Micro Fiber Fabric (If Equipped)

**Note:** Do not steam clean.

**Note:** To avoid spots or discoloration, clean the entire surface.

Do not use the following products:

- Leather care products.
- Household cleaners.
- Alcoholic solutions.
- Spot removers.
- Shoe polish.

To clean:

- Remove dust and loose dirt with a vacuum cleaner.
- Wipe the surface with a soft, damp cloth and a mild soap and water solution. Dry the area with a clean, soft cloth.
- If a ring forms on the fabric after spot cleaning, clean the entire area immediately, but do not soak or the ring will set.

## Instrument Cluster Screens, LCD Screens and Radio Screens

**Note:** Do not use abrasives, alcoholic solvents or chemical solvents to clean the instrument cluster screens, LCD screens or radio screens. These cleaning products can damage the screens.

Clean the instrument panel and cluster lens with a clean, damp and soft cloth, then use a clean, dry and soft cloth to dry these areas.

Do not spray any liquid directly onto the screens.

Do not use a microfiber cloth to clean the bezel around the display screens as it could damage the surface.

## Rear Windows

**Note:** Do not use any abrasive materials to clean the interior of the rear windows.

**Note:** Do not install stickers or labels to the interior of the rear windows.

## Storage Compartments, Cup Holders and Ashtrays

To clean:

- Take out any removable inserts.
- Wipe the surface with a soft, damp cloth and a mild soap and water solution. Dry the area with a clean, soft cloth.

## CLEANING THE INSTRUMENT PANEL AND INSTRUMENT CLUSTER LENS



**WARNING:** Do not use chemical solvents or strong detergents when cleaning the steering wheel or instrument panel to avoid contamination of the airbag system.

**Note:** Follow the same procedure as cleaning leather seats for cleaning leather instrument panels and leather interior trim surfaces. See **Cleaning Leather Seats** (page 291).

Clean the instrument panel and cluster lens with a clean, damp and soft cloth, then use a clean, dry and soft cloth to dry these areas.

# Vehicle Care

---

- Avoid cleaners or polishes that increase the gloss of the upper portion of the instrument panel. The dull finish in this area helps protect you from undesirable windshield reflection.
- Do not use any household cleaning products or glass cleaners as these may damage the finish of the instrument panel, interior trim and cluster lens.
- Wash or wipe your hands clean if you have been in contact with certain products such as insect repellent and suntan lotion to avoid possible damage to the interior painted surfaces.
- Do not allow air fresheners and hand sanitizers to spill onto interior surfaces. If a spill occurs, wipe off immediately. Your warranty may not cover these damages.

If a staining liquid like coffee or juice has been spilled on the instrument panel or on interior trim surfaces:

1. Wipe up spilled liquid using a clean, soft cloth as quickly as possible.
2. Use Motorcraft Premium Leather and Vinyl Cleaner or a commercially available leather cleaning product for automotive interiors. Test any cleaner or stain remover on an inconspicuous area.
3. Alternatively, wipe the surface with a clean, soft cloth and a mild soap and water solution. Dry the area with a clean, soft cloth.
4. If necessary, apply more soap and water solution or cleaning product to a clean, soft cloth and press it onto the soiled area. Allow this to set at room temperature for 30 minutes.
5. Remove the soaked cloth, then with a clean, damp cloth, use a rubbing motion for 60 seconds on the soiled area.

6. Dry the area with a clean, soft cloth.

## CLEANING LEATHER SEATS (if

Equipped)

**Note:** *Follow the same procedure as cleaning leather seats for cleaning leather instrument panels and leather interior trim surfaces.*

For routine cleaning, wipe the surface with a soft, damp cloth and a mild soap and water solution. Dry the area with a clean, soft cloth.

For cleaning and removing stains such as dye transfer, use Motorcraft Premium Leather and Vinyl Cleaner or a commercially available leather cleaning product for automotive interiors.

**Note:** *Test any cleaner or stain remover on an inconspicuous area.*

You should:

- Remove dust and loose dirt with a vacuum cleaner.
- Clean and treat spills and stains as soon as possible.

Do not use the following products as these may damage the leather:

- Oil and petroleum or silicone-based leather conditioners.
- Household cleaners.
- Alcohol solutions.
- Solvents or cleaners intended specifically for rubber, vinyl and plastics.

# Vehicle Care

---

## REPAIRING MINOR PAINT DAMAGE

You should repair paintwork damage caused by stones from the road or minor scratches as soon as possible. A choice of products are available from an authorized dealer.

Remove particles such as bird droppings, tree sap, insect deposits, tar spots, road salt and industrial fallout before repairing paint chips.

Always read and follow the manufacturer's instructions before using the products.

## CLEANING THE WHEELS

1. Regularly clean them with a wheel cleaner. We recommend that you use Ford approved wheel cleaner if available.
2. Remove dirt and brake dust with a sponge.
3. Remove tar and grease with a bug and tar remover. We recommend that you use Ford approved bug and tar remover if available.
4. Thoroughly rinse the wheels with water after cleaning.

If you intend on parking your vehicle for an extended period after cleaning the wheels with a wheel cleaner, drive your vehicle for a few minutes before doing so. This reduces the risk of corrosion of the brake discs, brake pads and linings.

Do not clean the wheels when they are hot.

**Note:** *Some car washes could damage wheel rims and covers.*

**Note:** *Using non-recommended cleaners, harsh cleaning products, chrome wheel cleaners or abrasive materials could damage wheel rims and covers.*

## VEHICLE STORAGE

If you plan on storing your vehicle for 30 days or more, read the following maintenance recommendations to make sure your vehicle stays in good operating condition.

We engineer and test all motor vehicles and their components for reliable, regular driving. Under various conditions, long-term storage may lead to degraded engine performance or failure unless you use specific precautions to preserve engine components.

### General

- Store all vehicles in a dry, ventilated place.
- Protect from sunlight, if possible.
- If vehicles are stored outside, they require regular maintenance to protect against rust and damage.

### Body

- Wash your vehicle thoroughly to remove dirt, grease, oil, tar or mud from exterior surfaces, rear-wheel housing and the underside of front fenders.
- Periodically wash your vehicle if it is stored in exposed locations.
- Touch-up exposed or primed metal to prevent rust.
- Cover chrome and stainless steel parts with a thick coat of auto wax to prevent discoloration. Re-wax as necessary when you wash your vehicle.
- Lubricate all hood, door and luggage compartment hinges and latches with a light grade oil.
- Cover interior trim to prevent fading.
- Keep all rubber parts free from oil and solvents.



# Vehicle Care

---

## Engine

- Change the engine oil and filter prior to storage because used engine oil contains contaminants which may cause engine damage.
- Start the engine every 15 days for a minimum of 15 minutes. Run at fast idle with the climate controls set to defrost until the engine reaches normal operating temperature.
- With your foot on the brake, shift through all the gears while the engine is running.
- We recommend that you change the engine oil before you use your vehicle again.

## Fuel system

- Fill the fuel tank with high-quality fuel until the first automatic shutoff of the fuel pump nozzle.

## Cooling system

- Protect against freezing temperatures.
- When removing your vehicle from storage, check coolant fluid level. Confirm that there are no cooling system leaks and that fluid is at the recommended level.

## Battery

- Check and recharge as necessary. Keep connections clean.
- If storing your vehicle for more than 30 days without recharging the battery, we recommend that you disconnect the battery cables to maintain battery charge for quick starting.

**Note:** *It is necessary to reset memory features if battery cables are disconnected.*

## Brakes

- Make sure the brakes and parking brake release fully.

## Tires

- Maintain recommended air pressure.

## Miscellaneous

- Make sure all linkages, cables, levers and pins under your vehicle are covered with grease to prevent rust.
- Move vehicles at least 25 ft (7.5 m) every 15 days to lubricate working parts and prevent corrosion.

## Removing Vehicle From Storage

When your vehicle is ready to come out of storage, do the following:

- Wash your vehicle to remove any dirt or grease film build-up on window surfaces.
- Check windshield wipers for any deterioration.
- Check under the hood for any foreign material that may have collected during storage such as mice or squirrel nests.
- Check the exhaust for any foreign material that may have collected during storage.
- Check tire pressures and set tire inflation per the Tire Label.
- Check brake pedal operation. Drive your vehicle 15 ft (4.5 m) back and forth to remove rust build-up.
- Check fluid levels (including coolant, oil and gas) to make sure there are no leaks, and fluids are at recommended levels.
- If you remove the battery, clean the battery cable ends and check for damage.

# Vehicle Care

---

Contact an authorized dealer if you have any concerns or issues.

# Wheels and Tires

## GENERAL INFORMATION

### Notice to Utility Vehicle, Van and Truck Owners



**WARNING:** Utility vehicles have a significantly higher rollover rate than other types of vehicles. To reduce the risk of serious injury or death from a rollover or other crash you must avoid sharp turns and abrupt maneuvers, drive at safe speeds for the conditions, keep tires properly inflated, never overload or improperly load your vehicle, and make sure every passenger is properly restrained.



**WARNING:** In a rollover crash, an unbelted person is significantly more likely to die than a person wearing a seat belt. All occupants must wear seat belts. Children and infants must use appropriate restraints to minimize the risk of injury or ejection.



E145298

Utility vehicles and trucks handle differently than passenger cars in the various driving conditions that are encountered on streets, highways and off-road. Utility vehicles and trucks are not designed for cornering at speeds as high as passenger cars any more than low-slung sports cars are designed to perform satisfactorily under off-road conditions.

### How Your Vehicle Differs from Other Vehicles

Sport-utility vehicles, vans and trucks can differ from some other vehicles in a few noticeable ways. Your vehicle may be:

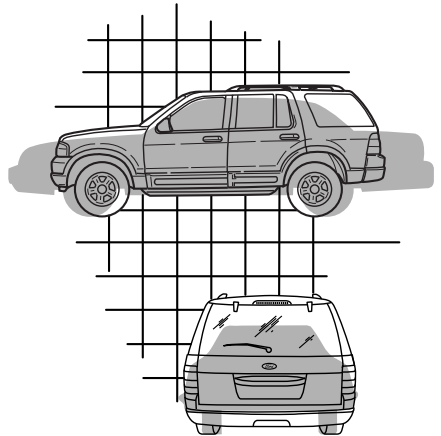

E145299

# Wheels and Tires

- Higher - to allow higher load carrying capacity and to allow it to travel over rough terrain without getting hung up or damaging underbody components.
- Shorter - to give it the capability to approach inclines and drive over the crest of a hill without getting hung up or damaging underbody components. All other things held equal, a shorter wheelbase may make your vehicle quicker to respond to steering inputs than a vehicle with a longer wheelbase.
- Narrower - to provide greater maneuverability in tight spaces, particularly in off-road use.

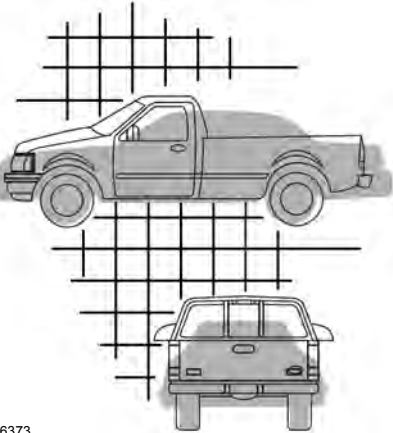

E166373

As a result of the above dimensional differences, sport-utility vehicles, vans and trucks often will have a higher center of gravity and a greater difference in center of gravity between the loaded and unloaded condition.

These differences that make your vehicle so versatile also make it handle differently than an ordinary passenger car.

## TIRE SEALANT AND INFLATOR KIT



**WARNING:** Do not use the inflator kit on run flat tires. This could cause loss of vehicle control.



**WARNING:** Depending on the type and extent of tire damage, some tires can only be partially sealed or not sealed at all. Loss of tire pressure can affect vehicle handling, leading to loss of vehicle control.



**WARNING:** Do not use the kit on a previously damaged tire, for example when it has been driven under inflated. This could cause loss of vehicle control, personal injury or death.

If your vehicle does not have a spare wheel it has a tire sealant and inflator kit. The kit is in the luggage compartment. Only use the kit supplied with your vehicle.

**Note:** *The kit can only temporarily repair one tire puncture with a maximum puncture size of up to 0.24 in (6 mm).*

# Wheels and Tires

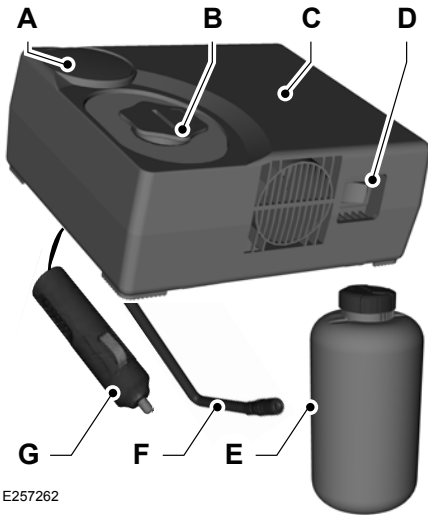

- A Pressure Gauge.
- B Sealant bottle access cap.
- C Warning label.
- D Power switch.
- E Sealant bottle.
- F Tire inflation pipe.
- G 12 volt DC power point connector.

**Note:** Make sure you regularly check the expiry date on the sealant bottle.



If the low tire pressure warning lamp illuminates do the following:

1. Gradually reduce the vehicle speed and stop your vehicle as soon as it is safe to do so.
2. Apply the parking brake and switch the ignition off.

3. Check for a punctured tire.

**Note:** Do not remove objects, for example nails or screws from a punctured tire.

## Using the Tire Sealant and Inflator Kit



**WARNING:** Check the sidewall of the tire prior to inflation. If there are any cracks, bumps or similar damage, do not attempt to inflate the tire. This could cause personal injury.



**WARNING:** Watch the sidewall of the tire when inflating. If any cracks, bumps or similar damage appears, switch the compressor off and let the air out by means of the pressure relief valve. Do not continue driving with this tire. This could cause loss of vehicle control.



**WARNING:** Do not stand directly beside the tire while the compressor is operating. This could cause personal injury if the tire bursts.



**WARNING:** Do not leave the kit unattended when it is in use. Failure to follow this instruction could result in personal injury or death.



**WARNING:** Do not keep the compressor operating for more than 10 minutes. This could cause the compressor to malfunction causing serious personal injury.

To temporarily repair a punctured tire, do the following:

## Wheels and Tires



E257263

1. Release the tire inflation pipe and the 12 volt DC power point connector from the underside of the compressor.

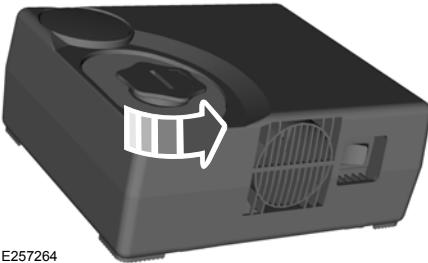

E257264

2. Turn the sealant bottle access cap counterclockwise and remove it.

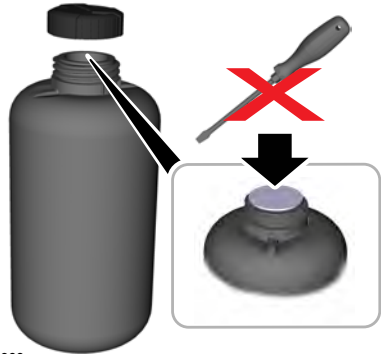

E256963

3. Remove the sealant bottle cap. Do not pierce or remove the seal.

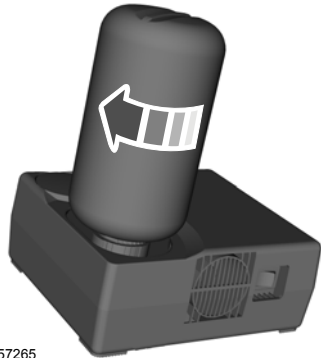

E257265

4. Attach the sealant bottle to the compressor. Turn the sealant bottle clockwise until you feel a strong resistance.

**Note:** *Attaching the sealant bottle to the compressor pierces the seal. Do not loosen the bottle as sealant could escape.*

# Wheels and Tires

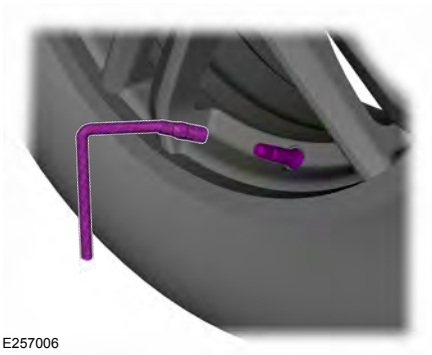

5. Remove the tire valve dust cap and attach the tire inflation pipe.



8. Switch the compressor on.



6. Plug the 12 volt DC power point connector into the 12 volt DC socket. See **Auxiliary Power Points** (page 131).
7. Start the engine.



9. Inflate the tire to between 29–44 psi (2–3 bar).

**Note:** If the tire pressure does not reach 26 psi (1.8 bar) within 10 minutes, the tire could be damaged beyond a temporary repair. Have your vehicle immediately checked. Do not drive your vehicle.

10. When the tire reaches the recommended tire pressure of between 29–44 psi (2–3 bar), switch the compressor and the ignition off.

# Wheels and Tires

11. Disconnect the tire inflation pipe and the 12 volt DC power point connector.

**Note:** Do not remove the sealant bottle from the compressor.

12. Reinstall the tire valve dust cap.
13. Place the warning label on the steering wheel and correctly stow the kit.



E257942

14. Immediately drive your vehicle for 2–6 mi (3–10 km). Do not exceed 50 mph (80 km/h).



E257121

15. After driving between 2–6 mi (3–10 km), stop your vehicle and recheck the tire pressure. See **Tire Pressures** (page 324).

**Note:** If the tire pressure has dropped to 26 psi (1.8 bar) or below, the tire could be damaged beyond a temporary repair. Have your vehicle immediately checked. Do not drive your vehicle.

**Note:** If the tire pressure has dropped but is still above 26 psi (1.8 bar), use the kit to inflate the tire again.

## After Using the Tire Sealant and Inflator Kit

**WARNING:** If you experience heavy vibrations, unsteady steering behavior or noises while driving, reduce your speed gradually and stop your vehicle as soon as it is safe to do so. Recheck the tire and its pressure. If the tire pressure is less than 18.9 psi (1.3 bar) or if there are any cracks, bumps or similar damage visible, do not continue driving with this tire. This could cause loss of vehicle control.

The kit only provides temporary mobility. Regulations concerning tire repair or replacement after using the kit could differ from country to country. We recommend you consult a tire specialist.

After using the kit:

- Do not drive your vehicle more than 124 mi (200 km) before repairing or replacing the punctured tire.
- Inform all other users of your vehicle that a tire was sealed using the kit. Make them aware of the special driving conditions that must be observed.



# Wheels and Tires

- Regularly check the tire pressure until the sealed tire is repaired or replaced by a tire specialist. Before the tire is removed from the rim, you must inform the tire specialist that the tire contains sealant.
- Take the kit to an authorized dealer to have the sealant bottle and the tire inflation pipe replaced.

## TIRE CARE

### Information About Uniform Tire Quality Grading



E142542

Tire Quality Grades apply to new pneumatic passenger car tires. The tire Quality Grades can be found where applicable on the tire sidewall between tread shoulder and maximum section width. For example: **Treadwear 200 Traction AA Temperature A.**

These Tire Quality Grades are determined by standards that the United States Department of Transportation has set.

Tire Quality Grades apply to new pneumatic passenger car tires. They do not apply to deep tread, winter-type snow tires, space-saver or temporary use spare tires, light truck or LT type tires, tires with nominal rim diameters of 10 to 12 inches or limited production tires as defined in Title 49 Code of Federal Regulations Part 575.104 (c)(2).

**U.S. Department of Transportation-Tire quality grades:** The U.S. Department of Transportation requires Ford Motor Company to give you the following information about tire grades exactly as the government has written it.

### Treadwear

The treadwear grade is a comparative rating based on the wear rate of the tire when tested under controlled conditions on a specified government test course. For example, a tire graded 150 would wear 1½ times as well on the government course as a tire graded 100. The relative performance of tires depends upon the actual conditions of their use, however, and may depart significantly from the norm due to variations in driving habits, service practices, and differences in road characteristics and climate.

# Wheels and Tires

## Traction AA A B C



**WARNING:** The traction grade assigned to this tire is based on straight-ahead braking traction tests, and does not include acceleration, cornering, hydroplaning or peak traction characteristics.

The traction grades, from highest to lowest are AA, A, B, and C. The grades represent the tire's ability to stop on wet pavement as measured under controlled conditions on specified government test surfaces of asphalt and concrete. A tire marked C may have poor traction performance.

## Temperature A B C



**WARNING:** The temperature grade for this tire is established for a tire that is properly inflated and not overloaded. Excessive speed, under-inflation, or excessive loading, either separately or in combination, can cause heat buildup and possible tire failure.

The temperature grades are A (the highest), B and C, representing the tire's resistance to the generation of heat and its ability to dissipate heat when tested under controlled conditions on a specified indoor laboratory test wheel. Sustained high

temperature can cause the material of the tire to degenerate and reduce tire life, and excessive temperature can lead to sudden tire failure. The grade C corresponds to a level of performance which all passenger car tires must meet under the Federal Motor Vehicle Safety Standard No. 139. Grades B and A represent higher levels of performance on the laboratory test wheel than the minimum required by law.

## Glossary of Tire Terminology

\* **Tire label:** A label showing the OE (Original Equipment) tire sizes, recommended inflation pressure and the maximum weight the vehicle can carry.

\* **Tire Identification Number (TIN):** A number on the sidewall of each tire providing information about the tire brand and manufacturing plant, tire size and date of manufacture. Also referred to as DOT code.

\* **Inflation pressure:** A measure of the amount of air in a tire.

\* **Standard load:** A class of P-metric or Metric tires designed to carry a maximum load at 35 psi [36 psi (2.5 bar) for Metric tires]. Increasing the inflation pressure beyond this pressure will not increase the tire's load carrying capability.

# Wheels and Tires

---

\***Extra load:** A class of P-metric or Metric tires designed to carry a heavier maximum load at 42 psi (2.9 bar). Increasing the inflation pressure beyond this pressure will not increase the tire's load carrying capability.

\***kPa:** Kilopascal, a metric unit of air pressure.

\***PSI:** Pounds per square inch, a standard unit of air pressure.

\***Cold tire pressure:** The tire pressure when the vehicle has been stationary and out of direct sunlight for an hour or more and prior to the vehicle being driven for 1 mile (1.6 kilometers).

\***Recommended inflation pressure:** The cold inflation pressure found on the Safety Compliance Certification Label (affixed to either the door hinge pillar, door-latch post, or the door edge that meets the door-latch post, next to the driver's seating position) or Tire Label located on the B-Pillar or the edge of the driver's door.

\***B-pillar:** The structural member at the side of the vehicle behind the front door.

\* **Bead area of the tire:** Area of the tire next to the rim.

\* **Sidewall of the tire:** Area between the bead area and the tread.

\* **Tread area of the tire:** Area of the perimeter of the tire that contacts the road when mounted on the vehicle.

\***Rim:** The metal support (wheel) for a tire or a tire and tube assembly upon which the tire beads are seated.

## Information Contained on the Tire Sidewall

Both U.S. and Canada Federal regulations require tire manufacturers to place standardized information on the sidewall of all tires. This information identifies and describes the fundamental characteristics of the tire and also provides a U.S. DOT Tire Identification Number for safety standard certification and in case of a recall.

# Wheels and Tires

## Information on P Type Tires

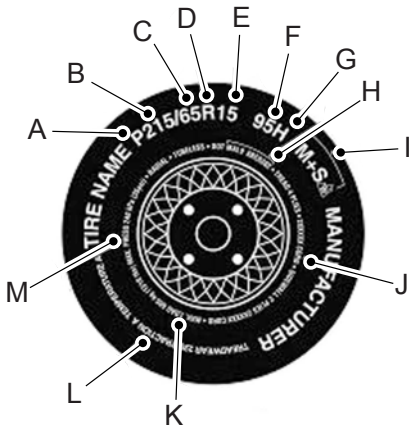

E142543

P215/65R15 95H is an example of a tire size, load index and speed rating. The definitions of these items are listed below. (Note that the tire size, load index and speed rating for your vehicle may be different from this example.)

A. **P:** Indicates a tire, designated by the Tire and Rim Association, that may be used for service on cars, sport utility vehicles, minivans and light trucks. **Note:** If your tire size does not begin with a letter, this may mean it is designated by either ETRTO (European Tire and Rim Technical Organization) or JATMA (Japan Tire Manufacturing Association).

B. **215:** Indicates the nominal width of the tire in millimeters from sidewall edge to sidewall edge. In general, the larger the number, the wider the tire.

C. **65:** Indicates the aspect ratio which gives the tire's ratio of height to width.

D. **R:** Indicates a radial type tire.

E. **15:** Indicates the wheel or rim diameter in inches. If you change your wheel size, you will have to purchase new tires to match the new wheel diameter.

F. **95:** Indicates the tire's load index. It is an index that relates to how much weight a tire can carry. You may find this information in your owner's manual. If not, contact a local tire dealer.

**Note:** You may not find this information on all tires because it is not required by federal law.

G. **H:** Indicates the tire's speed rating. The speed rating denotes the speed at which a tire is designed to be driven for extended periods of time under a standard condition of load and inflation pressure. The tires on your vehicle may operate at different conditions for load and inflation pressure. These speed ratings may need to be adjusted for the difference in conditions. The ratings range from 81 mph (130 km/h) to 186 mph (299 km/h). These ratings are listed in the following chart.

# Wheels and Tires

**Note:** You may not find this information on all tires because it is not required by federal law.

Letter rating	Speed rating - mph (km/h)
M	81 mph (130 km/h)
N	87 mph (140 km/h)
Q	99 mph (159 km/h)
R	106 mph (171 km/h)
S	112 mph (180 km/h)
T	118 mph (190 km/h)
U	124 mph (200 km/h)
H	130 mph (210 km/h)
V	149 mph (240 km/h)
W	168 mph (270 km/h)
Y	186 mph (299 km/h)

**Note:** For tires with a maximum speed capability over 149 mph (240 km/h), tire manufacturers sometimes use the letters ZR. For those with a maximum speed capability over 186 mph (299 km/h), tire manufacturers always use the letters ZR.

**H. U.S. DOT Tire Identification Number (TIN):** This begins with the letters DOT and indicates that the tire meets all federal standards. The next two numbers or letters are the plant code designating where it was manufactured, the next two are

the tire size code and the last four numbers represent the week and year the tire was built. For example, the numbers 317 mean the 31st week of 1997. After 2000 the numbers go to four digits. For example, 2501 means the 25th week of 2001. The numbers in between are identification codes used for traceability. This information is used to contact customers if a tire defect requires a recall.

**I. M+S or M/S:** Mud and Snow, or

**AT:** All Terrain, or

**AS:** All Season.

**J. Tire Ply Composition and Material Used:** Indicates the number of plies or the number of layers of rubber-coated fabric in the tire tread and sidewall. Tire manufacturers also must indicate the ply materials in the tire and the sidewall, which include steel, nylon, polyester, and others.

**K. Maximum Load:** Indicates the maximum load in kilograms and pounds that can be carried by the tires. Refer to the Safety Compliance Certification Label (affixed to either the door hinge pillar, door-latch post, or the door edge that meets the door-latch post, next to the driver's seating position), for the correct tire pressure for your vehicle.

**L. Treadwear, Traction and Temperature Grades:**

# Wheels and Tires

**\*Treadwear** The treadwear grade is a comparative rating based on the wear rate of the tire when tested under controlled conditions on a specified government test course. For example, a tire graded 150 would wear one and one-half times as well on the government course as a tire graded 100.

**\*Traction:** The traction grades, from highest to lowest are AA, A, B, and C. The grades represent the tire's ability to stop on wet pavement as measured under controlled conditions on specified government test surfaces of asphalt and concrete. A tire marked C may have poor traction performance.

**\*Temperature:** The temperature grades are A (the highest), B and C, representing the tire's resistance to the generation of heat and its ability to dissipate heat when tested under controlled conditions on a specified indoor laboratory test wheel.

## M. Maximum Inflation

**Pressure:** Indicates the tire manufacturer's maximum permissible pressure or the pressure at which the maximum load can be carried by the tire. This pressure is normally higher than the manufacturer's recommended cold inflation pressure, which can be found on the Safety Compliance Certification Label (affixed to either the door hinge pillar, door-latch post, or the door edge that meets the door-latch

post, next to the driver's seating position), or Tire Label which is located on the B-Pillar or the edge of the driver's door. The cold inflation pressure should never be set lower than the recommended pressure on the vehicle label.

The tire suppliers may have additional markings, notes or warnings such as standard load, radial tubeless, etc.

## Additional Information Contained on the Tire Sidewall for LT Type Tires

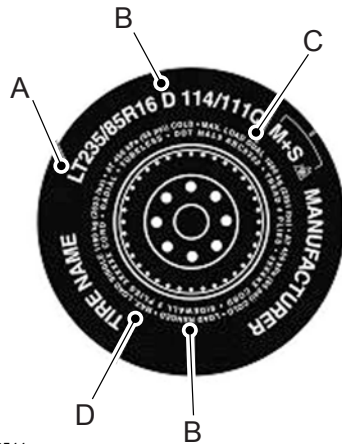

E142544

LT type tires have some additional information beyond those of P type tires; these differences are described below.

**Note:** *Tire Quality Grades do not apply to this type of tire.*

# Wheels and Tires

A. **LT:** Indicates a tire, designated by the Tire and Rim Association (T&RA), that is intended for service on light trucks.

B. **Load Range and Load Inflation Limits:** Indicates the tire's load-carrying capabilities and its inflation limits.

C. **Maximum Load Dual lb (kg) at psi (kPa) cold:** Indicates the maximum load and tire pressure when the tire is used as a dual, defined as four tires on the rear axle (a total of six or more tires on the vehicle).

D. **Maximum Load Single lb (kg) at psi (kPa) cold:** Indicates the maximum load and tire pressure when the tire is used as a single, defined as two tires (total) on the rear axle.

## Information on T Type Tires

T type tires have some additional information beyond those of P type tires; these differences are described below:

T145/80D16 is an example of a tire size.

**Note:** *The temporary tire size for your vehicle may be different from this example. Tire Quality Grades do not apply to this type of tire.*



E142545

A. **T:** Indicates a type of tire, designated by the Tire and Rim Association, that is intended for temporary service on cars, sport-utility vehicles, minivans and light trucks.

B. **145:** Indicates the nominal width of the tire in millimeters from sidewall edge to sidewall edge. In general, the larger the number, the wider the tire.

C. **80:** Indicates the aspect ratio which gives the tire's ratio of height to width. Numbers of 70 or lower indicate a short sidewall.

D. **D:** Indicates a diagonal type tire.

# Wheels and Tires

**R:** Indicates a radial type tire.

**E. 16:** Indicates the wheel or rim diameter in inches. If you change your wheel size, you will have to purchase new tires to match the new wheel diameter.

## Location of the Tire Label

You will find a Tire Label containing tire inflation pressure by tire size and other important information located on the B-Pillar or the edge of the driver's door.

## Inflating Your Tires

Safe operation of your vehicle requires that your tires are properly inflated. Remember that a tire can lose up to half of its air pressure without appearing flat.

Every day before you drive, check your tires. If one looks lower than the others, use a tire gauge to check pressure of all tires and adjust if required.

At least once a month and before long trips, inspect each tire and check the tire pressure with a tire gauge (including spare, if equipped). Inflate all tires to the inflation pressure recommended by Ford Motor Company.



**WARNING:** Under-inflation is the most common cause of tire failures and may result in severe tire cracking, tread separation or blowout, with unexpected loss of vehicle control and increased risk of injury. Under-inflation increases sidewall flexing and rolling resistance, resulting in heat buildup and internal damage to the tire. It also may result in unnecessary tire stress, irregular wear, loss of vehicle control and accidents. A tire can lose up to half of its air pressure and not appear to be flat!

You are strongly urged to buy a reliable tire pressure gauge, as automatic service station gauges may be inaccurate. Ford recommends the use of a digital or dial-type tire pressure gauge rather than a stick-type tire pressure gauge.

Use the recommended cold inflation pressure for optimum tire performance and wear. Under-inflation or over-inflation may cause uneven treadwear patterns.

Always inflate your tires to the Ford recommended inflation pressure even if it is less than the maximum inflation pressure information found on the tire. The Ford recommended tire inflation pressure is found on the Safety Compliance Certification Label (affixed to either the door hinge



## Wheels and Tires

---

pillar, door-latch post, or the door edge that meets the door-latch post, next to the driver's seating position), or Tire Label which is located on the B-Pillar or the edge of the driver's door. Failure to follow the tire pressure recommendations can cause uneven treadwear patterns and adversely affect the way your vehicle handles.

**Maximum Inflation Pressure** is the tire manufacturer's maximum permissible pressure or the pressure at which the maximum load can be carried by the tire. This pressure is normally higher than the manufacturer's recommended cold inflation pressure, which can be found on the Safety Compliance Certification Label (affixed to either the door hinge pillar, door-latch post, or the door edge that meets the door-latch post, next to the driver's seating position), or Tire Label which is located on the B-Pillar or the edge of the driver's door. The cold inflation pressure should never be set lower than the recommended pressure on the Safety Compliance Certification Label or Tire Label.

When weather temperature changes occur, tire inflation pressures also change. A 10°F (6°C) temperature drop can cause a corresponding drop of 1 psi (7 kPa) in inflation pressure. Check your tire pressures frequently and adjust them to the proper pressure which can be found on the Safety Compliance Certification Label or Tire Label.

To check the pressure in your tire(s):

1. Make sure the tires are cool, meaning they are not hot from driving even a mile.

**Note:** *If you are checking tire pressure when the tire is hot, (i.e. driven more than 1 mile [1.6 km]), never bleed or reduce air pressure. The tires are hot from driving and it is normal for pressures to increase above recommended cold pressures. A hot tire at or below recommended cold inflation pressure could be significantly under-inflated.*

**Note:** *If you have to drive a distance to get air for your tire(s), check and record the tire pressure first and add the appropriate air pressure when you get to the pump. It is normal for tires to heat up and the air pressure inside to go up as you drive.*

2. Remove the cap from the valve on one tire, then firmly press the tire gauge onto the valve and measure the pressure.

# Wheels and Tires

---

3. Add enough air to reach the recommended air pressure.

**Note:** *If you overfill the tire, release air by pressing on the metal stem in the center of the valve. Then recheck the pressure with your tire gauge.*

4. Replace the valve cap.

5. Repeat this procedure for each tire, including the spare.

**Note:** *Some spare tires operate at a higher inflation pressure than the other tires. For T-type mini-spare tires, refer to the Dissimilar spare wheel and tire assembly information for a description. Store and maintain at 60 psi (4.15 bar). For full-size and dissimilar spare tires, refer to the Dissimilar spare wheel and tire assembly information for a description. Store and maintain at the higher of the front and rear inflation pressure as shown on the Tire Label.*

6. Visually inspect the tires to make sure there are no nails or other objects embedded that could poke a hole in the tire and cause an air leak.

7. Check the sidewalls to make sure there are no gouges, cuts or bulges.

## Inspecting Your Tires and Wheel Valve Stems

Periodically inspect the tire treads for uneven or excessive wear and remove objects such as stones, nails or glass that may be wedged in the tread grooves. Check the tire and valve stems for holes, cracks, or cuts that may permit air leakage and repair or replace the tire and replace the valve stem. Inspect the tire sidewalls for cracking, cuts, bruises and other signs of damage or excessive wear. If internal damage to the tire is suspected, have the tire demounted and inspected in case it needs to be repaired or replaced. For your safety, tires that are damaged or show signs of excessive wear should not be used because they are more likely to blow out or fail.

Improper or inadequate vehicle maintenance can cause tires to wear abnormally. Inspect all your tires, including the spare, frequently, and replace them if one or more of the following conditions exist:

# Wheels and Tires

## Tire Wear

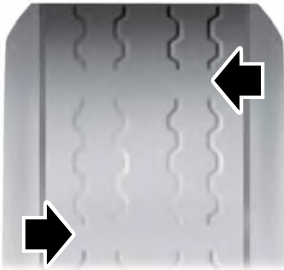

E142546

When the tread is worn down to 1/16th of an inch (2 mm), tires must be replaced to help prevent your vehicle from skidding and hydroplaning. Built-in treadwear indicators, or wear bars, which look like narrow strips of smooth rubber across the tread will appear on the tire when the tread is worn down to 1/16th of an inch (2 mm).

When the tire tread wears down to the same height as these wear bars, the tire is worn out and must be replaced.

## Damage

Periodically inspect the tire treads and sidewalls for damage (such as bulges in the tread or sidewalls, cracks in the tread groove and separation in the tread or sidewall). If damage is observed

or suspected have the tire inspected by a tire professional. Tires can be damaged during off-road use, so inspection after off-road use is also recommended.

## Age



**WARNING:** Tires degrade over time depending on many factors such as weather, storage conditions, and conditions of use (such as load, speed, inflation pressure, etc.) the tires experience throughout their lives. In general, tires should be replaced after six years regardless of tread wear. However, heat caused by hot climates or frequent high loading conditions can accelerate the aging process and may require tires to be replaced more frequently. You should replace your spare tire when you replace the road tires or after six years due to aging even if it has not been used.

## U.S. DOT Tire Identification Number (TIN)

Both U.S. and Canada Federal regulations require tire manufacturers to place standardized information on the sidewall of all tires. This information identifies and

# Wheels and Tires

describes the fundamental characteristics of the tire and also provides a U.S. DOT Tire Identification Number for safety standard certification and in case of a recall.

This begins with the letters DOT and indicates that the tire meets all federal standards. The next two numbers or letters are the plant code designating where it was manufactured, the next two are the tire size code and the last four numbers represent the week and year the tire was built. For example, the numbers 317 mean the 31st week of 1997. After 2000 the numbers go to four digits. For example, 2501 means the 25th week of 2001. The numbers in between are identification codes used for traceability. This information is used to contact customers if a tire defect requires a recall.

## Tire Replacement Requirements

Your vehicle is equipped with tires designed to provide a safe ride and handling capability.

 **WARNING:** Only use replacement tires and wheels that are the same size, load index, speed rating and type (such as P-metric versus LT-metric or all-season versus all-terrain) as those originally provided by Ford. The recommended tire and wheel

size may be found on either the Safety Compliance Certification Label (affixed to either the door hinge pillar, door-latch post, or the door edge that meets the door-latch post, next to the driver's seating position), or the Tire Label which is located on the B-Pillar or edge of the driver's door. If this information is not found on these labels, then you should contact your authorized dealer as soon as possible. Use of any tire or wheel not recommended by Ford can affect the safety and performance of your vehicle, which could result in an increased risk of loss of vehicle control, vehicle rollover, personal injury and death. Additionally the use of non-recommended tires and wheels could cause steering, suspension, axle, transfer case or power transfer unit failure. If you have questions regarding tire replacement, contact your authorized dealer as soon as possible.

 **WARNING:** When mounting replacement tires and wheels, you should not exceed the maximum pressure indicated on the sidewall of the tire to set the beads without additional precautions listed below. If the beads do not seat at the maximum pressure indicated, re-lubricate and try again.

# Wheels and Tires

When inflating the tire for mounting pressures up to 20 psi (1.38 bar) greater than the maximum pressure on the tire sidewall, the following precautions must be taken to protect the person mounting the tire:

1. Make sure that you have the correct tire and wheel size.
2. Lubricate the tire bead and wheel bead seat area again.
3. Stand at a minimum of 12 ft (3.66 m) away from the wheel and tire assembly.
4. Use both eye and ear protection.

For a mounting pressure more than 20 psi (1.38 bar) greater than the maximum pressure, a Ford dealer or other tire service professional should do the mounting.

Always inflate steel carcass tires with a remote air fill with the person inflating standing at a minimum of 12 ft (3.66 m) away from the wheel and tire assembly.

**Important:** Remember to replace the wheel valve stems when the road tires are replaced on your vehicle.

It is recommended that the two front tires or two rear tires generally be replaced as a pair.

The tire pressure sensors mounted in the wheels (originally installed on your vehicle) are not designed to be used in aftermarket wheels.

The use of wheels or tires not recommended by Ford Motor Company may affect the operation of your tire pressure monitoring system.

If the tire pressure monitoring system indicator is flashing, your tire pressure monitoring system is malfunctioning. Your replacement tire might be incompatible with your TPMS, or some component of the TPMS may be damaged.

## Safety Practices



**WARNING:** If your vehicle is stuck in snow, mud, sand, etc., do not rapidly spin the tires. Spinning the tires can tear the tire and cause an explosion. A tire can explode in as little as three to five seconds.



**WARNING:** Do not spin the wheels at over 35 mph (56 km/h). The tires may fail and injure a passenger or bystander.

**Driving habits have a great deal to do with your tire mileage and safety.**

- \*Observe posted speed limits.
- \*Avoid fast starts, stops and turns.
- \*Avoid potholes and objects on the road.
- \*Do not run over curbs or hit the tire against a curb when parking.

# Wheels and Tires

## Highway Hazards

No matter how carefully you drive there is always the possibility that you may eventually have a flat tire on the highway. Drive slowly to the closest safe area out of traffic. This may further damage the flat tire, but your safety is more important.

If you feel a sudden vibration or ride disturbance while driving, or you suspect your tire or vehicle has been damaged, immediately reduce your speed. Drive with caution until you can safely pull off the road. Stop and inspect the tires for damage. If a tire is under-inflated or damaged, deflate it, remove wheel and replace it with your spare tire and wheel. If you cannot detect a cause, have the vehicle towed to the nearest repair facility or tire dealer to have the vehicle inspected.

## Tire and Wheel Alignment

A bad jolt from hitting a curb or pothole can cause the front end of your vehicle to become misaligned or cause damage to your tires. If your vehicle seems to pull to one side when you are driving, the wheels may be out of alignment. Have an authorized dealer check the wheel alignment periodically.

Wheel misalignment in the front or the rear can cause uneven and rapid treadwear of your tires and should be corrected by an authorized dealer. Front-wheel drive vehicles and those with an independent rear suspension (if equipped) may require alignment of all four wheels.

The tires should also be balanced periodically. An unbalanced tire and wheel assembly may result in irregular tire wear.

## Tire Rotation



**WARNING:** If the tire label shows different tire pressures for the front and rear tires and the vehicle is equipped with a tire pressure monitoring system, then the settings for the system sensors need to be updated. Always perform the system reset procedure after tire rotation. If the system is not reset, it may not provide a low tire pressure warning when necessary. See **Tire Pressure Monitoring System** (page 316).

**Note:** *If your tires show uneven wear ask an authorized dealer to check for and correct any wheel misalignment, tire imbalance or mechanical problem involved before tire rotation.*

# Wheels and Tires

**Note:** Your vehicle may be equipped with a dissimilar spare wheel and tire assembly. A dissimilar spare wheel and tire assembly is defined as a spare wheel and tire assembly that is different in brand, size or appearance from the road tires and wheels. If you have a dissimilar spare wheel and tire assembly it is intended for temporary use only and should not be used in a tire rotation.

**Note:** After having your tires rotated, inflation pressure must be checked and adjusted to the vehicle requirements.

Rotating your tires at the recommended interval (as indicated in the Scheduled Maintenance chapter) will help your tires wear more evenly, providing better tire performance and longer tire life.

Front-wheel drive vehicles (front tires on the left side of the diagram)

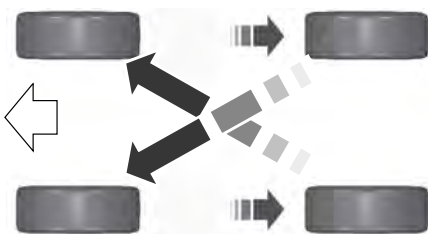

E142547

Sometimes irregular tire wear can be corrected by rotating the tires.

## USING WINTER TIRES

**WARNING:** When you use winter tires on your vehicle, you must make sure that you use the correct lug nuts.

If winter tires are used, you must make sure that you use the correct tire pressures.

## USING SNOW CHAINS

**WARNING:** Do not exceed 30 mph (50 km/h). Failure to follow this instruction could result in the loss of control of your vehicle, personal injury or death.

**WARNING:** Do not use snow chains on snow-free roads.

**WARNING:** Only fit snow chains to specified tires.

**WARNING:** If your vehicle is fitted with wheel trims, remove them before fitting snow chains.

Only use snow chains on the front wheels. Do not use self-tensioning snow chains.

Only use snow chains on the following specified tire sizes:

- 205/60R16.
- 215/55R16.

**Note:** Do not use snow chains greater than 0.4 in (10 mm).

Maintain correct tire pressures. See **Tire Pressures** (page 324).

# Wheels and Tires

## Vehicles with Stability Control

When stability control is on, your vehicle may exhibit some unusual driving characteristics. To reduce this, switch traction control off. See **Stability Control** (page 177).

**Note:** *The anti-lock brake system continues to correctly operate.*

## TIRE PRESSURE MONITORING SYSTEM



**WARNING:** The tire pressure monitoring system is not a substitute for manually checking tire pressures. You should periodically check tire pressures using a pressure gauge. Failure to correctly maintain tire pressures could increase the risk of tire failure, loss of control, vehicle rollover and personal injury.

**Note:** *You should only use tire sealants in roadside emergencies as they may cause damage to the tire pressure monitoring system sensor.*

**Note:** *If the tire pressure monitoring system sensor becomes damaged, it may not function.*



Each tire, including the spare (if provided), should be checked monthly when cold and inflated to the inflation pressure recommended by the vehicle manufacturer on the vehicle placard or tire inflation pressure label. (If your vehicle has tires of a different size than the size indicated on the vehicle placard or tire inflation pressure label, you should determine the proper tire inflation pressure for those tires).

As an added safety feature, your vehicle has been equipped with a Tire Pressure Monitoring System (TPMS) that illuminates a low tire pressure telltale when one or more of your tires is significantly under-inflated. Accordingly, when the low tire pressure telltale illuminates, you should stop and check your tires as soon as possible, and inflate them to the proper pressure. Driving on a significantly under-inflated tire causes the tire to overheat and can lead to tire failure. Under-inflation also reduces fuel efficiency and tire tread life, and may affect the vehicle's handling and stopping ability.

Please note that the TPMS is not a substitute for proper tire maintenance, and it is the driver's responsibility to maintain correct tire pressure, even if under-inflation has not reached the level to trigger illumination of the TPMS low tire pressure telltale.

Your vehicle has also been equipped with a TPMS malfunction indicator to indicate when the system is not operating properly. The TPMS malfunction indicator is combined with the low tire pressure telltale. When the system detects a malfunction, the telltale will flash for approximately one minute and then remain continuously illuminated. This sequence will continue upon subsequent vehicle start-ups as long as the malfunction exists.

When the malfunction indicator is illuminated, the system may not be able to detect or signal low tire pressure as intended. TPMS malfunctions may occur for a variety of reasons, including the installation of replacement or alternate tires or wheels on the vehicle that prevent the TPMS from functioning properly. Always check the TPMS malfunction telltale after replacing one or more tires or wheels on your vehicle to ensure that the replacement or alternate tires and wheels allow the TPMS to continue to function properly.



# Wheels and Tires

This device complies with Part 15 of the FCC Rules and with License exempt RSS Standards of Industry Canada. Operation is subject to the following two conditions:

1. This device may not cause harmful interference, and
2. This device must accept any interference received, including interference that may cause undesired operation.

**Note:** Changes or modifications not expressly approved by the party responsible for compliance could void the user's authority to operate the equipment. The term "IC:" before the radio certification number only signifies that Industry Canada technical specifications were met.

## Changing Tires With a Tire Pressure Monitoring System



E142549

**Note:** Each road tire is equipped with a tire pressure sensor located inside the wheel and tire assembly cavity. The pressure sensor is attached to the valve stem. The pressure sensor is covered by the tire and is not visible unless the tire is removed. Take care when changing the tire to avoid damaging the sensor.

You should always have your tires serviced by an authorized dealer.

Check the tire pressure periodically (at least monthly) using an accurate tire gauge. See **When Inflating Your Tires** in this chapter.

## Understanding Your Tire Pressure Monitoring System



The tire pressure monitoring system measures pressure in your road tires and sends the tire pressure readings to your vehicle. You can view the tire pressure readings through the information display. See **General Information** (page 92). The low tire pressure warning light will turn on if the tire pressure is significantly low. Once the light is illuminated, your tires are under-inflated and need to be inflated to the manufacturer's recommended tire pressure. Even if the light turns on and a short time later turns off, your tire pressure still needs to be checked.

## When Your Temporary Spare Tire is Installed

When one of your road tires needs to be replaced with the temporary spare, the system will continue to identify an issue to remind you that the damaged road wheel and tire assembly needs to be repaired and put back on your vehicle.

# Wheels and Tires

To restore the full function of the tire pressure monitoring system, have the damaged road wheel and tire assembly repaired and remounted on your vehicle.

## When You Believe Your System is Not Operating Properly

The main function of the tire pressure monitoring system is to warn you when your tires need air. It can also warn you in the event the system is no longer capable of functioning as intended. See the following chart for information concerning your tire pressure monitoring system:

Low tire pressure warning light	Possible cause	Customer action required
Solid warning light	Tire(s) under-inflated	Make sure tires are at the proper pressure. See Inflating your tires in this chapter. After inflating your tires to the manufacturer's recommended pressure as shown on the Tire Label (located on the edge of driver's door or the B-Pillar), the vehicle must be driven for at least two minutes over 20 mph (32 km/h) before the light turns off.
	Spare tire in use	Repair the damaged road wheel and tire assembly and reinstall it on the vehicle to restore system function. For a description on how the system functions, see <b>When Your Temporary Spare Tire is Installed</b> in this section.
	TPMS malfunction	If the tires are properly inflated and the spare tire is not in use but the light remains on, contact your authorized dealer as soon as possible.
Flashing warning light	Spare tire in use	Repair the damaged road wheel and tire assembly and reinstall it on the vehicle to restore system function. For a description on how the system functions, see <b>When Your Temporary Spare Tire is Installed</b> in this section.
	TPMS malfunction	If the tires are properly inflated and the spare tire is not in use but the light remains on, contact your authorized dealer as soon as possible.

# Wheels and Tires

## When Inflating Your Tires



**WARNING:** Do not use the tire pressure displayed in the information display as a tire pressure gauge. Failure to follow this instruction could result in personal injury or death.

When putting air into your tires (such as at a gas station or in your garage), the tire pressure monitoring system may not respond immediately to the air added to your tires.

It may take up to two minutes of driving over 20 mph (32 km/h) for the light to turn off after you have filled your tires to the recommended inflation pressure.

## How Temperature Affects Your Tire Pressure

The tire pressure monitoring system monitors tire pressure in each pneumatic tire. While driving in a normal manner, a typical passenger tire inflation pressure may increase about 2–4 psi (14–28 kPa) from a cold start situation. If the vehicle is stationary overnight with the outside temperature significantly lower than the daytime temperature, the tire pressure may decrease about 3 psi (21 kPa) for a drop of 30°F (17°C) in ambient temperature. This low pressure value may be detected by the tire pressure monitoring system as being significantly lower than the recommended inflation pressure and activate the system warning light for low tire pressure. If the low tire pressure warning light is on, visually check each tire to verify that no tire is flat. If one or more tires are flat, repair as necessary. Check the air pressure in the road tires. If any tire is under-inflated, carefully drive the vehicle to the nearest location where air can be added to the tires. Inflate all the tires to the recommended inflation pressure.

## Tire Pressure Monitoring System Reset Procedure

### Overview

You must carry out the system reset procedure after each tire replacement or adjustment of the tire pressures.

To maintain your vehicle load carrying capability, your vehicle may require different tire pressures in the front compared to the rear. In these cases, the system illuminates the warning lamp at different pressures for the front and rear tires.

If the tires are rotated, you need to reset the system in order to relearn the positions of the tire pressure sensors. The system cannot tell which position a tire pressure sensor is in, and assumes you have set the tire pressures correctly.

### Performing the Reset Procedure

1. Switch the ignition on.
2. Navigate to the tire monitor menu in the information display. See **Information Messages** (page 94).
3. Press and hold the OK button until a confirmation message appears. If your vehicle has a tire pressure monitoring system reset button, press and hold the button until a confirmation message appears.

# Wheels and Tires

## CHANGING A ROAD WHEEL



**WARNING:** The use of tire sealants may damage your tire pressure monitoring system and should only be used in roadside emergencies. If you must use a sealant, the Ford Tire Mobility Kit sealant should be used. The tire pressure monitoring system sensor and valve stem on the wheel must be replaced by an authorized dealer after use of the sealant.



**WARNING:** If the tire pressure monitor sensor becomes damaged, it will no longer function. See **Tire Pressure Monitoring System** (page 316).

**Note:** *The tire pressure monitoring system indicator light will illuminate when the spare tire is in use. To restore the full function of the monitoring system, all road wheels equipped with tire pressure monitoring sensors must be mounted on the vehicle.*

If you get a flat tire while driving, do not apply the brake heavily. Instead, gradually decrease your speed. Hold the steering wheel firmly and slowly move to a safe place on the side of the road.

Have a flat serviced by an authorized dealer in order to prevent damage to the tire pressure monitoring system sensors. See **Tire Pressure Monitoring System** (page 316). Replace the spare tire with a road tire as soon as possible. During repairing or replacing of the flat tire, have an authorized dealer inspect the tire pressure monitoring system sensor for damage.

## Dissimilar Spare Wheel and Tire Assembly Information



**WARNING:** Failure to follow these guidelines could result in an increased risk of loss of vehicle control, injury or death.

If you have a dissimilar spare wheel and tire, then it is intended for temporary use only. This means that if you need to use it, you should replace it as soon as possible with a road wheel and tire assembly that is the same size and type as the road tires and wheels that were originally provided by Ford. If the dissimilar spare tire or wheel is damaged, it should be replaced rather than repaired.

A dissimilar spare wheel and tire assembly is defined as a spare wheel and tire assembly that is different in brand, size or appearance from the road tires and wheels and can be one of three types:

- 1. T-type mini-spares:** This spare tire begins with the letter T for tire size and may have Temporary Use Only molded in the sidewall.
- 2. Full-size dissimilar spare with label on wheel:** This spare tire has a label on the wheel that states: THIS WHEEL AND TIRE ASSEMBLY FOR TEMPORARY USE ONLY.

When driving with one of the dissimilar spare tires listed above, do not:

- Exceed 50 mph (80 km/h).
- Load the vehicle beyond maximum vehicle load rating listed on the Safety Compliance Label.
- Tow a trailer.
- Use snow chains on the end of the vehicle with the dissimilar spare tire.
- Use more than one dissimilar spare tire at a time.

# Wheels and Tires

- Use commercial car washing equipment.
- Try to repair the dissimilar spare tire.

Use of one of the dissimilar spare tires listed above at any one wheel location can lead to impairment of the following:

- Handling, stability and braking performance.
- Comfort and noise.
- Ground clearance and parking at curbs.
- Winter weather driving capability.
- Wet weather driving capability.
- All-wheel driving capability (if applicable).

### 3. Full-size dissimilar spare without label on wheel

When driving with the full-size dissimilar spare wheel and tire assembly, do not:

- Exceed 70 mph (113 km/h).
- Use more than one dissimilar spare wheel and tire assembly at a time.
- Use commercial car washing equipment.
- Use snow chains on the end of the vehicle with the dissimilar spare wheel and tire assembly.

The usage of a full-size dissimilar spare wheel and tire assembly can lead to impairment of the following:

- Handling, stability and braking performance.
- Comfort and noise.
- Ground clearance and parking at curbs.
- Winter weather driving capability.
- Wet weather driving capability.
- All-wheel driving capability.

When driving with the full-size dissimilar spare wheel and tire assembly additional caution should be given to:

- Towing a trailer.
- Driving vehicles equipped with a camper body.
- Driving vehicles with a load on the cargo rack.

Drive cautiously when using a full-size dissimilar spare wheel and tire assembly and seek service as soon as possible.

## Changing a Road Wheel



**WARNING:** When one of the front wheels is off the ground, the transmission alone will not prevent the vehicle from moving or slipping off the jack, even if the transmission selector lever is in park (P).



**WARNING:** To help prevent your vehicle from moving when you change a tire, be sure to place the transmission selector lever in park (P), set the parking brake and block (in both directions) the wheel that is diagonally opposite (other side and end of the vehicle) to the tire being changed.



**WARNING:** Never get underneath a vehicle that is supported only by a jack. If your vehicle slips off the jack, you or someone else could be seriously injured.



**WARNING:** Do not attempt to change a tire on the side of the vehicle close to moving traffic. Pull far enough off the road to avoid the danger of being hit when operating the jack or changing the wheel.

## Wheels and Tires



**WARNING:** Always use the jack provided as original equipment with your vehicle. If using a jack other than the one provided as original equipment with your vehicle, make sure the jack capacity is adequate for the vehicle weight, including any vehicle cargo or modifications.

**Note:** The jack and tools are located behind a cover in the sidewall at the left rear of the cargo area. Remove the retention straps and wing nut before removing the jack.

The jack and tools are located behind a cover in the left rear of the cargo area. Remove the wing nut to remove the jack. Remove the lug nut wrench from the clips by pulling straight out.

1. Park on a level surface, set the parking brake and activate the hazard flashers.
2. Move the transmission selector lever to the park (P) position and switch the ignition off.

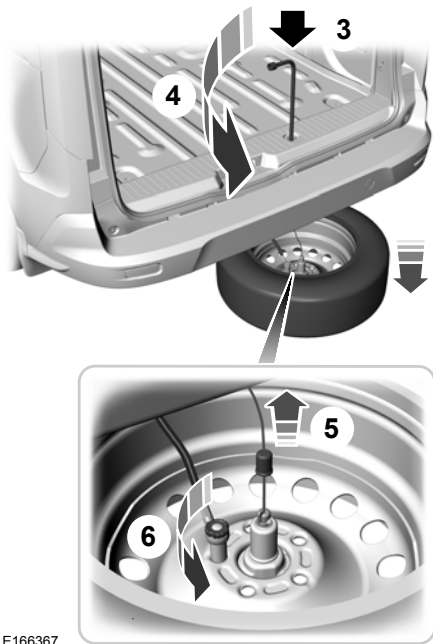

E166367

3. Open the cap in the rear of the vehicle and insert the end of the lug wrench into the guide hole.
4. Turn the handle counterclockwise and lower the spare tire until it rests on the ground and the cable is slack.
5. Detach the first cable by pulling the cap up and sliding it away from the wheel. Then turn the end of the cable so it fits through the slot and remove the cable and bracket.
6. Detach the second cable by unscrewing the bolt.

# Wheels and Tires

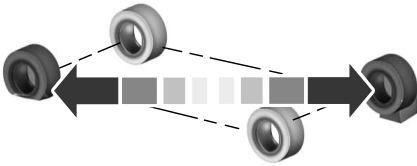

E142551

7. Block the diagonally opposite wheel.



E166369

8. Install the plastic wheel cover remover to the lug wrench. Insert the wrench end between the rim and the wheel cover through the gaps and carefully remove the cover.
9. Loosen each wheel lug nut one-half turn counterclockwise but do not remove them until the wheel is raised off the ground.

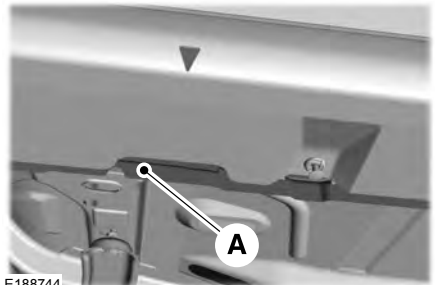

E188744

10. Arrows on the sill panel cover show the location of the jacking points (A).



E142553

11. Align the slot on top of the jack with the sheet metal flange indicated by the jack locator triangle next to the tire you are changing. Turn the jack handle clockwise until the wheel is completely off the ground.

**Note:** *Passengers should not remain in the vehicle when the vehicle is being jacked.*

12. Remove the lug nuts with the lug wrench.
13. Replace the flat tire with the spare tire, making sure the valve stem is facing outward. Reinstall the lug nuts until the wheel is snug against the hub. Do not fully tighten the lug nuts until the wheel has been lowered.

# Wheels and Tires

14. Lower the wheel by turning the jack handle counterclockwise.

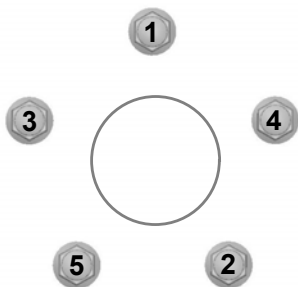

E75442

15. Remove the jack and fully tighten the lug nuts in the order shown. Tighten the lug nuts to the correct specification. See **Lug Nuts** (page 325).
16. Fit the wheel cover onto the rim making sure the valve stem aligns with the indent in the ring on the back of the cover. Tap it with the palm of your hand to lock it into place.

## Stowing the Flat or Spare Tire

Do not raise the spare wheel carrier without the wheel attached. Damage can occur to the winch mechanism if lowered without a wheel attached.

**Note:** Failure to follow spare tire stowage instructions may result in failure of cable or loss of spare tire.

**Note:** Do not lay alloy wheels face down on the ground, this will damage the paint. When stowing the flat tire use a sheet or mat under the wheel to protect the paint.

1. Stow the flat or spare tire with the valve stem facing downward.

2. Slide the wheel partially under the vehicle and install the retainer through the wheel center. Pull on the cables to align the components at the end of the cables.
3. Attach the second cable by screwing the bolt into one of the holes in the wheel.
4. Turn the end of the first cable so it fits through the slot and install the cable. Then slide the cap over the retainer.
5. Turn the jack handle clockwise to raise the tire to its stowed position underneath the vehicle. The effort to turn the jack handle increases significantly when the tire is raised to the maximum tightness. Tighten to the best of your ability.
6. Check that the tire is flat against the frame and is fully tight. Try to push or pull, then turn the tire to be sure it will not move. Loosen and retighten, if necessary. Failure to properly stow the spare tire may result in failure of the winch cable and loss of the tire.
7. Repeat this tightness check procedure when servicing the spare tire pressure (every six months, per scheduled maintenance information), or at any time that the spare tire is disturbed through service of other components.

Return the jack and tools to the storage position in the cargo area.

## TIRE PRESSURES

The recommended tire inflation pressures are on the tire information label on the driver side B-pillar.

Check all tire pressures when they are cold, at least once every two weeks.

**Note:** You may need to remove the spare wheel from the spare wheel carrier to check the tire pressure.



# Wheels and Tires

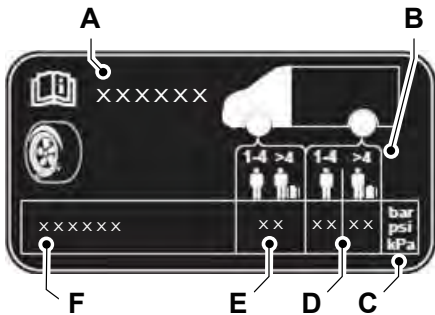

E254145

- A Vehicle model.
- B Vehicle load.
- C Measure unit.
- D Rear tire pressure.
- E Front tire pressure.
- F Tire size.

## Spare Tire

Tire Size	Van	Wagon
	psi (bar)	psi (bar)
215/55 R16 97V XL	44 psi (3 bar)	42 psi (2.9 bar)

## LUG NUTS

### Wheel Lug Nut Torque Specifications

**WARNING:** When a wheel is installed, always remove any corrosion, dirt or foreign materials present on the mounting surfaces of the wheel or the surface of the wheel hub, brake drum or brake disc that contacts the wheel. Make sure that any fasteners that attach the rotor to the hub are secured so they do not interfere with the mounting surfaces of the wheel. Installing wheels without correct metal-to-metal contact at the wheel mounting surfaces can cause the wheel nuts to loosen and the wheel to come off while your vehicle is in motion, resulting in loss of control.

Bolt size	lb-ft (Nm)*
M14 x 1.5	162 lb.ft (220 Nm)

\*Torque specifications are for nut and bolt threads free of dirt and rust. Use only Ford recommended replacement fasteners.

Retighten the lug nuts to the specified torque within 100 miles (160 kilometers) after any wheel disturbance, for example tire rotation, changing a flat tire or wheel removal.

# Wheels and Tires

---



E145950

A Wheel pilot bore

Inspect the wheel pilot bore and mounting surface prior to installation. Remove any visible corrosion or loose particles.

## Capacities and Specifications

---

### ENGINE SPECIFICATIONS - 1.5L DURATORQ-TDCI DIESEL

<b>Engine</b>	<b>1.5L TDCi</b>
Cubic inches.	91
Firing order.	1-3-4-2
Compression ratio.	16.4:1

## Capacities and Specifications

---

### ENGINE SPECIFICATIONS - 2.0L DURATEC-HE (MI4)/2.0L FLEX FUEL

<b>Engine</b>	<b>2.0L GDI</b>
Cubic inches.	121
Firing order.	1-3-4-2
Ignition system.	Coil on plug
Spark plug gap.	0.033–0.037 in (0.85–0.95 mm)
Compression ratio.	12.0:1

# Capacities and Specifications

---

## ENGINE SPECIFICATIONS - 2.5L

<b>Specifications</b>	
Cubic inches.	152
Compression ratio.	9.7:1
Spark plug gap.	0.049–0.053 in (1.25–1.35 mm)
Required fuel.	Minimum 87 octane

## Capacities and Specifications

---

### MOTORCRAFT PARTS - 1.5L DURATORQ-TDCI DIESEL

Component	Part Number
Air filter element.	FA-1928
Oil filter.	FL-2082
Fuel filter.	FD-4650
Cabin air filter.	FP-70 (front) FP-75 (auxiliary AC)
Windshield wiper blade.	WW-2954 (driver side) WW-2953 (passenger side)
Rear window wiper blade.	WW-2930

**Note:** Motorcraft replacement parts are recommended for scheduled maintenance and are available at an authorized dealer or at [fordparts.com](http://fordparts.com). These parts meet or exceed Ford Motor Company's specifications, and are engineered for your vehicle. Use of other parts may impact vehicle performance, emissions and durability. Your warranty may be void for any damage related to use of other parts.

**Note:** Should a Motorcraft oil filter not be available, use an oil filter that meets industry performance specification SAE/USCAR-36.

## Capacities and Specifications

### MOTORCRAFT PARTS - 2.0L DURATEC-HE (MI4)/2.0L FLEX FUEL

Component	Part Number
Air filter element.	FA-1928
Oil filter.	FL-2082
Spark plugs.	SP-535
Cabin air filter.	FP-70 (front) FP-75 (auxiliary AC)
Windshield wiper blade.	WW-2954 (driver side) WW-2953 (passenger side)
Rear window wiper blade.	WW-2930

**Note:** Motorcraft replacement parts are recommended for scheduled maintenance and are available at an authorized dealer or at [fordparts.com](http://fordparts.com). These parts meet or exceed Ford Motor Company's specifications, and are engineered for your vehicle. Use of other parts may impact vehicle performance, emissions and durability. Your warranty may be void for any damage related to use of other parts.

**Note:** Should a Motorcraft oil filter not be available, use an oil filter that meets industry performance specification SAE/USCAR-36.

**Note:** For spark plug replacement, see an authorized dealer. Replace the spark plugs at the appropriate intervals. Refer to Scheduled Maintenance for the replacement intervals. See **Normal Scheduled Maintenance** (page 419).

# Capacities and Specifications

---

## MOTORCRAFT PARTS - 2.5L

Component	Part Number
Air filter element.	FA-1910
Oil filter.	FL-910S
Battery.	BXT-40R
Spark plugs.	SP-530
Cabin air filter.	FP-70 (front) FP-75 (auxiliary AC)
Windshield wiper blade.	WW-2954 (driver side) WW-2953 (passenger side)
Rear window wiper blade.	WW-2930

**Note:** Motorcraft replacement parts are recommended for scheduled maintenance and are available at an authorized dealer or at [fordparts.com](http://fordparts.com). These parts meet or exceed Ford Motor Company's specifications, and are engineered for your vehicle. Use of other parts may impact vehicle performance, emissions and durability. Your warranty may be void for any damage related to use of other parts.

**Note:** Should a Motorcraft oil filter not be available, use an oil filter that meets industry performance specification SAE/USCAR-36.

**Note:** For spark plug replacement, see an authorized dealer. Replace the spark plugs at the appropriate intervals. Refer to Scheduled Maintenance for the replacement intervals. See **Normal Scheduled Maintenance** (page 419).



# Capacities and Specifications

## VEHICLE IDENTIFICATION NUMBER

The vehicle identification number is located on the left-hand side of the instrument panel.

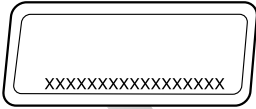

E142476

Please note that in the graphic, XXXX is representative of your vehicle identification number.

The Vehicle Identification Number contains the following information:

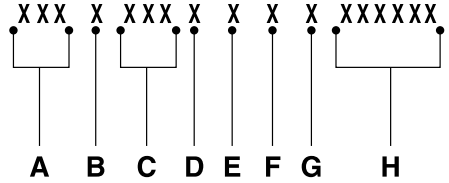

E142477

- A World manufacturer identifier
- B Brake system, Gross Vehicle Weight Rating, Restraint Devices and their locations
- C Make, vehicle line, series, body type
- D Engine type
- E Check digit
- F Model year
- G Assembly plant
- H Production sequence number

# Capacities and Specifications

## VEHICLE CERTIFICATION LABEL

MFD. BY FORD MOTOR CO.			
DATE: XX/XX	GVWR: XXXX KG (XXXX LB)		
FRONT GAWR:	REAR GAWR:		
XXXX KG (XXXX LB)	WITH	XXXX KG (XXXX LB)	WITH
XXXXXXXXXXXXXXXXXX	TIRES	XXXXXXXXXXXXXXXXXX	TIRES
XXXXXX	RIMS	XXXXXX	RIMS
AT XXXX kPa/ XXX PSI COLD	AT	XXXX kPa/ XXX PSI COLD	
THIS VEHICLE CONFORMS TO ALL APPLICABLE FEDERAL MOTOR VEHICLE SAFETY AND THEFT PREVENTION STANDARDS IN EFFECT ON THE DATE OF MANUFACTURE SHOWN ABOVE.			
VIN: XXXXXXXXXXXXXXXXXXXX	XXXXX XXXXX		
			
EXT PNT: XX	XXXXXX	RC: XX	D50: XXXX
WB INT TR	T/P/PS	R AXLE	TR SPR
XXX XX	XXX X	XX X	XXXX XXXX
XXXXXXXXXXXXXXXXXX XXX XXXX-XXXXXXXX-XX			

E167469

The National Highway Traffic Safety Administration Regulations require that a Safety Compliance Certification Label be affixed to a vehicle and prescribe where the Safety Compliance Certification Label may be located. The Safety Compliance Certification Label shall be affixed to either the door hinge pillar, the door latch post, or the edge of the door near the door latch, next to the driver's seating position.

## TRANSMISSION CODE DESIGNATION - 6-SPEED AUTOMATIC TRANSMISSION

MFD. BY FORD MOTOR CO.			
DATE: XX/XX	GVWR: XXXXX LB/ XXXXX KG		
FRONT GAWR: XXXXL	REAR GAWR: XXXXLB		
XXXXKG	WITH	XXXXKG	WITH
XXXX/XXXXXXXXXX	TIRES	XXXX/XXXXXXXXXX	TIRES
XXXX.XX	RIMS	XXXX.XX	RIMS
AT XXX kPa/XX PSI COLD	AT	XXX kPa/XX PSI COLD	
THIS VEHICLE CONFORMS TO ALL APPLICABLE FEDERAL MOTOR VEHICLE SAFETY STANDARDS IN EFFECT ON THE DATE OF MANUFACTURE SHOWN ABOVE.			
VIN: XXXXXXXXXXXXXXXXXXXX	XXXXXX XXXXXX		
			
EXT PNT: XX	RC: XX	D50: XXXX	
WB INT TR	T/P/PS	R AXLE	TR SPR
XXX XX	XXX X	XX X	XXXX XXXX
XXXXXXXXXXXXXXXXXX XX XXXX-XXXXXXXX-XX			

E142806

The transmission code is on the Safety Compliance Certification Label. The following table shows the transmission code along with the transmission description.

# Capacities and Specifications

Code	Description
6	Six-speed automatic transmission 6F35

Code	Description
8	Eight-speed automatic transmission 8F35

## TRANSMISSION CODE DESIGNATION - 8-SPEED AUTOMATIC TRANSMISSION

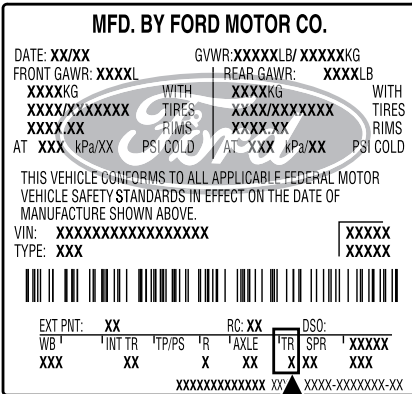

E142806

The transmission code is on the Safety Compliance Certification Label. The following table shows the transmission code along with the transmission description.

## Capacities

Variant	Refrigerant	Refrigerant Oil
All.	28.2 oz (0.8 kg)	6.8 fl oz (200 ml)

## CAPACITIES AND SPECIFICATIONS - 1.5L DURATORQ-TDCI DIESEL

Use oil and fluid that meets the defined specification and viscosity grade.

If you do not use oil and fluid that meets the defined specification and viscosity grade, it could result in:

- Component damage not covered by the vehicle Warranty.
- Longer engine cranking periods.
- Increased emission levels.
- Reduced engine performance.
- Reduced fuel economy.
- Reduced brake performance.

## Air Conditioning System



**WARNING:** The air conditioning refrigerant system contains refrigerant under high pressure. Only qualified personnel should service the air conditioning refrigerant system. Opening the air conditioning refrigerant system can cause personal injury.

# Capacities and Specifications

---

## Materials

Name	Specification
R-1234yf Refrigerant (U.S.) R-1234yf Refrigerant / Frigorigène R-1234yf (Canada) YN-33-A (U.S.) HS7Z-19B519-BA (Canada)	WSS-M17B21-A
Motorcraft® R-1234yf Refrigerant PAG Oil (U.S.) Motorcraft® R-1234yf Refrigerant PAG Oil / Huile PAG pour frigorigène R-1234yf Motorcraft® (Canada) YN-35 (U.S. & Canada)	WSS-M2C300-A2

## Engine

### Engine Oil

An engine oil viscosity grade and specification label is on the underside of the hood.

# Capacities and Specifications

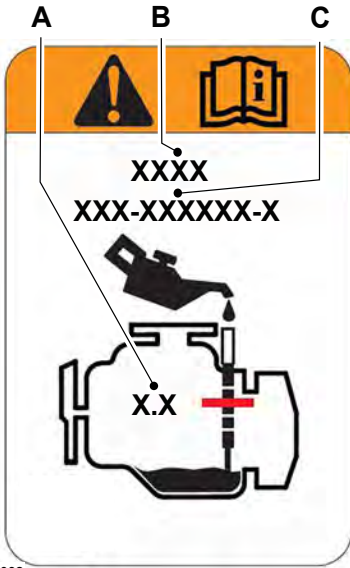

E248032

- A Engine oil fill capacity including the oil filter.
- B Engine oil viscosity grade.
- C Engine oil specification.

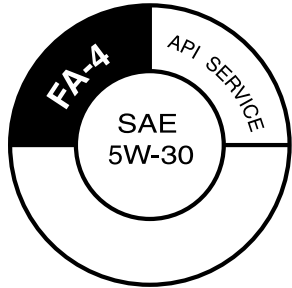

E258300

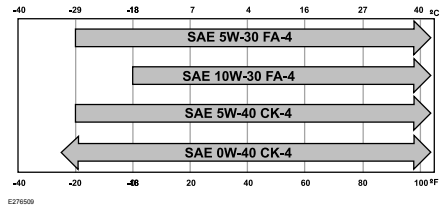

E276509

## Adding Engine Oil

Only add engine oil that meets the defined specification and viscosity grade in small quantities of no more than 0.13 gal (0.5 L).

Wait for one minute after each refill step to allow the engine oil to flow into the oil pan and register on the engine oil dipstick. See **Engine Oil Check** (page 266).

## Engine Coolant

### Capacities

Variant	Quantity
All.	8.5 qt (8 L)

# Capacities and Specifications

## Materials

Name	Specification
Motorcraft® Orange Prediluted Antifreeze/Coolant (U.S.) Motorcraft® Orange Prediluted Antifreeze/Coolant / Antigel/liquide de refroidissement prédilué orange Motorcraft® (Canada) VC-3DIL-B (U.S.) CVC-3DIL-B (Canada)	WSS-M97B44-D2

## Fuel Tank

### Capacities

Variant	Quantity
All.	14.5 gal (55 L)

## Diesel Exhaust Fluid

### Capacities

Variant	Quantity
All.	4.6 gal (17.6 L)

## Materials

Name	Specification
Motorcraft® Diesel Exhaust Fluid (U.S.) Motorcraft® Diesel Exhaust Fluid / Fluide pour échappement diesel Motorcraft® (Canada) PM-27-GAL, PM-27-JUG (U.S.) CPM-27-J (Canada)	WSS-M99C130-A

## Washer Reservoir

### Capacities

Variant	Quantity
All.	3.1 qt (2.9 L)

# Capacities and Specifications

## Materials

Name	Specification
Motorcraft® Premium Windshield Wash Concentrate with Bitterant (U.S.) Motorcraft® Premium Quality Windshield Washer Fluid / Liquide lave-glace de haute qualité Motorcraft® (Canada) ZC-32-B2 (U.S.) CXC-37-A/B/D/F (Canada)	WSS-M14P19-A

## Brake System

### Materials

Name	Specification
Motorcraft® DOT 4 LV High Performance Motor Vehicle Brake Fluid (U.S.) Motorcraft® DOT 4 LV High Performance Motor Vehicle Brake Fluid / Liquide de frein automobile haute performance DOT 4 LV Motorcraft® (Canada) PM-20 (U.S. & Canada)	WSS-M6C65-A2

## Automatic Transmission

You must use the correct fluid for automatic transmission that requires MERCON® ULV transmission fluid.

### Capacities

Variant	Quantity
All.	9.0 qt (8.5 L)

# Capacities and Specifications

## Materials

Name	Specification
Motorcraft® MERCON® ULV Automatic Transmission Fluid (U.S.) Motorcraft® MERCON® ULV Automatic Transmission Fluid / MERCON® ULV huile pour boîtes automatique Motorcraft® (Canada) XT-12-QLV (U.S. & Canada)	MERCON® ULVWSS-M2C949-A

## Locks

### Materials

Name	Specification
Motorcraft® Penetrating and Lock Lubricant (U.S.) Motorcraft® Penetrating Fluid / Liquide dégrissant Motorcraft® (Canada) XL-1 (U.S.) CXC-51-A (Canada)	-

## Grease

### Materials

Name	Specification
Motorcraft® Multi-Purpose Grease Spray (U.S.) Motorcraft® Multi-Purpose Grease Spray / Graisse tout usage en aérosol Motorcraft® (Canada) XL-5-A (U.S. & Canada)	ESB-M1C93-B

## CAPACITIES AND SPECIFICATIONS - 2.0L DURATEC-HE (MI4)/2.0L FLEX FUEL

Use oil and fluid that meets the defined specification and viscosity grade.

If you do not use oil and fluid that meets the defined specification and viscosity grade, it could result in:

- Component damage not covered by the vehicle Warranty.
- Longer engine cranking periods.
- Increased emission levels.
- Reduced engine performance.
- Reduced fuel economy.
- Reduced brake performance.



# Capacities and Specifications

## Air Conditioning System



**WARNING:** The air conditioning refrigerant system contains refrigerant

under high pressure. Only qualified personnel should service the air conditioning refrigerant system. Opening the air conditioning refrigerant system can cause personal injury.

## Capacities

Variant	Refrigerant	Refrigerant Oil
All.	29.1 oz (0.825 kg)	5.9 fl oz (175 ml)

## Materials

Name	Specification
R-1234yf Refrigerant (U.S.) R-1234yf Refrigerant / Frigorigène R-1234yf (Canada) YN-33-A (U.S.) HS7Z-19B519-BA (Canada)	WSS-M17B21-A
Motorcraft® R-1234yf Refrigerant PAG Oil (U.S.) Motorcraft® R-1234yf Refrigerant PAG Oil / Huile PAG pour frigorigène R-1234yf Motorcraft® (Canada) YN-35 (U.S. & Canada)	WSS-M2C300-A2

## Engine

### Engine Oil



E142732



E275759

An oil that displays this symbol conforms to current engine, emission system and fuel economy performance standards of the International Lubricants Specification Advisory Committee (ILSAC).

# Capacities and Specifications

We recommend Motorcraft® motor oil for your vehicle. If Motorcraft® oil is not available, use motor oils of the recommended viscosity grade that meet API SN PLUS requirements and display the

API Certification Mark for gasoline engines. Do not use oil labeled with API SN service category unless the label also displays the API certification mark.

## Capacities

Variant	Including the Oil Filter
All.	4.8 qt (4.54 L)

## Materials

Name	Specification
Engine Oil - SAE 5W-20 - Synthetic Blend Motor Oil (U.S.) Engine Oil - SAE 5W-20 - Super Premium Motor Oil / Huile moteur de très haute qualité SAE 5W-20 Motorcraft® (Canada) XO-5W20-Q1SP (U.S.) CXO-5W20-LSP6 (Canada)	WSS-M2C945-B1

## Engine Coolant

### Capacities

Variant	Quantity
All.	8.5 qt (8 L)

## Materials

Name	Specification
Motorcraft® Orange Prediluted Antifreeze/Coolant (U.S.) Motorcraft® Orange Prediluted Antifreeze/Coolant / Antigél/liquide de refroidissement prédilué orange Motorcraft® (Canada) VC-3DIL-B (U.S.) CVC-3DIL-B (Canada)	WSS-M97B44-D2

# Capacities and Specifications

## Fuel Tank

### Capacities

Variant	Quantity
All.	15.8 gal (59.8 L)

## Washer Reservoir

### Capacities

Variant	Quantity
All.	3.1 qt (2.9 L)

## Materials

Name	Specification
Motorcraft® Premium Windshield Wash Concentrate with Bitterant (U.S.) Motorcraft® Premium Quality Windshield Washer Fluid / Liquide lave-glace de haute qualité Motorcraft® (Canada) ZC-32-B2 (U.S.) CXC-37-A/B/D/F (Canada)	WSS-M14P19-A

## Brake System

### Materials

Name	Specification
Motorcraft® DOT 4 LV High Performance Motor Vehicle Brake Fluid (U.S.) Motorcraft® DOT 4 LV High Performance Motor Vehicle Brake Fluid / Liquide de frein automobile haute performance DOT 4 LV Motorcraft® (Canada) PM-20 (U.S. & Canada)	WSS-M6C65-A2

# Capacities and Specifications

## Automatic Transmission

automatic transmission that requires MERCON® ULV transmission fluid.

You must use the correct fluid for

## Capacities

Variant	Quantity
All.	9.0 qt (8.5 L)

## Materials

Name	Specification
Motorcraft® MERCON® ULV Automatic Transmission Fluid (U.S.) Motorcraft® MERCON® ULV Automatic Transmission Fluid / MERCON® ULV huile pour boîtes automatique Motorcraft® (Canada) XT-12-QULV (U.S. & Canada)	MERCON® ULVWSS-M2C949-A

## Locks

## Materials

Name	Specification
Motorcraft® Penetrating and Lock Lubricant (U.S.) Motorcraft® Penetrating Fluid / Liquide dégrippant Motorcraft® (Canada) XL-1 (U.S.) CXC-51-A (Canada)	-

## Grease

## Materials

Name	Specification
Motorcraft® Multi-Purpose Grease Spray (U.S.) Motorcraft® Multi-Purpose Grease Spray / Graisse tout usage en aérosol Motorcraft® (Canada) XL-5-A (U.S. & Canada)	ESB-MIC93-B

# Capacities and Specifications

## CAPACITIES AND SPECIFICATIONS - 2.5L

Use oil and fluid that meets the defined specification and viscosity grade.

If you do not use oil and fluid that meets the defined specification and viscosity grade, it could result in:

- Component damage not covered by the vehicle Warranty.
- Longer engine cranking periods.
- Increased emission levels.

- Reduced engine performance.
- Reduced fuel economy.
- Reduced brake performance.

## Air Conditioning System



**WARNING:** The air conditioning refrigerant system contains refrigerant under high pressure. Only qualified personnel should service the air conditioning refrigerant system. Opening the air conditioning refrigerant system can cause personal injury.

## Capacities

Variant	Refrigerant	Refrigerant Oil
All.	29.1 oz (0.825 kg)	5.9 fl oz (175 ml)

## Materials

Name	Specification
R-1234yf Refrigerant (U.S.) R-1234yf Refrigerant / Frigorigène R-1234yf (Canada) YN-33-A (U.S.) HS7Z-19B519-BA (Canada)	WSS-M17B21-A
Motorcraft® R-1234yf Refrigerant PAG Oil (U.S.) Motorcraft® R-1234yf Refrigerant PAG Oil / Huile PAG pour frigorigène R-1234yf Motorcraft® (Canada) YN-35 (U.S. & Canada)	WSS-M2C300-A2

# Capacities and Specifications

## Engine

### Engine Oil



E275759

E142732

An oil that displays this symbol conforms to current engine, emission system and fuel economy performance standards of the International Lubricants Specification Advisory Committee (ILSAC).

We recommend Motorcraft® motor oil for your vehicle. If Motorcraft® oil is not available, use motor oils of the recommended viscosity grade that meet API SN PLUS requirements and display the API Certification Mark for gasoline engines. Do not use oil labeled with API SN service category unless the label also displays the API certification mark.

## Capacities

Variant	Including the Oil Filter
All.	5.7 qt (5.4 L)

## Materials

Name	Specification
Engine Oil - SAE 5W-20 - Synthetic Blend Motor Oil (U.S.) Engine Oil - SAE 5W-20 - Super Premium Motor Oil / Huile moteur de très haute qualité SAE 5W-20 Motorcraft® (Canada) XO-5W20-Q1SP (U.S.) CXO-5W20-LSP6 (Canada)	WSS-M2C945-B1

# Capacities and Specifications

## Alternative Engine Oil for Extremely Cold Climates

To improve engine cold start performance,

we recommend that you use the following alternative engine oil in extreme cold climates, where the ambient temperature reaches  $-22^{\circ}\text{F}$  ( $-30^{\circ}\text{C}$ ) or below.

## Materials

Name	Specification
Engine Oil - SAE 0W-20 - Synthetic Blend Motor Oil (U.S.) (Canada) XO-0W20-Q1SP (U.S.)	WSS-M2C947-B1

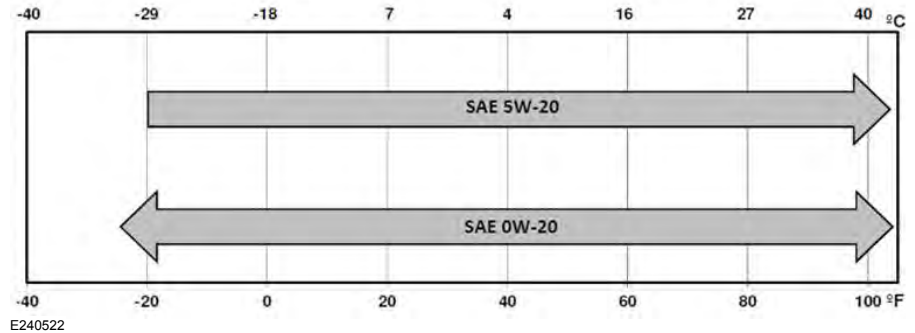

## Engine Coolant

### Capacities

Variant	Quantity
All.	8.5 qt (8 L)

# Capacities and Specifications

## Materials

Name	Specification
Motorcraft® Orange Prediluted Antifreeze/Coolant (U.S.) Motorcraft® Orange Prediluted Antifreeze/Coolant / Antigel/liquide de refroidissement prédilué orange Motorcraft® (Canada) VC-3DIL-B (U.S.) CVC-3DIL-B (Canada)	WSS-M97B44-D2

## Fuel Tank

### Capacities

Variant	Quantity
All.	15.8 gal (59.8 L)

## Washer Reservoir

### Capacities

Variant	Quantity
All.	3.1 qt (2.9 L)

## Materials

Name	Specification
Motorcraft® Premium Windshield Wash Concentrate with Bitterant (U.S.) Motorcraft® Premium Quality Windshield Washer Fluid / Liquide lave-glacé de haute qualité Motorcraft® (Canada) ZC-32-B2 (U.S.) CXC-37-A/B/D/F (Canada)	WSS-M14P19-A

## Brake System



# Capacities and Specifications

## Materials

Name	Specification
Motorcraft® DOT 4 LV High Performance Motor Vehicle Brake Fluid (U.S.) Motorcraft® DOT 4 LV High Performance Motor Vehicle Brake Fluid / Liquide de frein automobile haute performance DOT 4 LV Motorcraft® (Canada) PM-20 (U.S. & Canada)	WSS-M6C65-A2

## Automatic Transmission

You must use the correct fluid for automatic transmission that requires MERCON® LV transmission fluid.

## Capacities

Variant	Quantity
All.	9.0 qt (8.5 L)

## Materials

Name	Specification
Motorcraft® MERCON® LV Automatic Transmission Fluid (U.S.) Motorcraft® MERCON® LV Automatic Transmission Fluid / Huile pour boîte automatique MERCON® LV Motorcraft® (Canada) XT-10-QLVC (U.S.) CXT-10-LV6 (Canada)	MERCON® LV WSS-M2C938-A

## Locks

# Capacities and Specifications

## Materials

Name	Specification
Motorcraft® Penetrating and Lock Lubricant (U.S.) Motorcraft® Penetrating Fluid / Liquide dégrissant Motorcraft® (Canada) XL-1 (U.S.) CXC-51-A (Canada)	-

## Grease

### Materials

Name	Specification
Motorcraft® Multi-Purpose Grease Spray (U.S.) Motorcraft® Multi-Purpose Grease Spray / Graisse tout usage en aérosol Motorcraft® (Canada) XL-5-A (U.S. & Canada)	ESB-MIC93-B

## BULB SPECIFICATION CHART

Lamp	Specification	Power (Watt)
Rear lamp and stoplamp.	W21/5W.	21/5
Cornering lamps.	H11.	55
Front direction indicator.	PY24W.	24
Front fog lamp.	H11.	55
Front position lamp.	W5W.	5
Side marker lamp.	W5W.	5
Headlamp low beam.	H11.	55
Headlamp high beam.	H9.	55
Headlamp low beam and high beam. <sup>1</sup>	D3S.	35
Side direction indicator.	W5W.	5
License plate lamp. <sup>2</sup>	W5W.	5

## Capacities and Specifications

Lamp	Specification	Power (Watt)
License plate lamp. <sup>3</sup>	LED.	LED.
Rear direction indicator.	WY21W.	21
Reversing lamp.	921.	16

<sup>1</sup> Vehicles with HID headlamps.

<sup>2</sup> Vehicles with rear cargo doors.

<sup>3</sup> Vehicles with Liftgate.

LEDs are not serviceable. If a LED fails have your vehicle checked as soon as possible.

### Interior Lamps

Lamp	Specification	Power (Watt)
Luggage compartment lamp.	W6W.	6
Cargo area lamp. <sup>1</sup>	Festoon.	10
Map reading lamp.	W6W.	6

<sup>1</sup> If your vehicle has LED cargo area lamps they are not serviceable. If a LED fails have your vehicle checked as soon as possible.

# Audio System

## GENERAL INFORMATION



**WARNING:** Driving while distracted can result in loss of vehicle control, crash and injury. We strongly recommend that you use extreme caution when using any device that may take your focus off the road. Your primary responsibility is the safe operation of your vehicle. We recommend against the use of any hand-held device while driving and encourage the use of voice-operated systems when possible. Make sure you are aware of all applicable local laws that may affect the use of electronic devices while driving.

## Radio Frequencies and Reception Factors

AM and FM frequencies are established by the Federal Communications Commission (FCC) and the Canadian Radio and Telecommunications Commission (CRTC). Those frequencies are:

- AM: 530-1710 kHz
- FM: 87.9-107.9 MHz

**Note:** *Listening to loud audio for long periods of time could damage your hearing.*

Radio Reception Factors	
<b>Distance and strength</b>	The further you travel from an AM or FM station, the weaker the signal and the weaker the reception.
<b>Terrain</b>	Hills, mountains, tall buildings, bridges, tunnels, freeway overpasses, parking garages, dense tree foliage and thunderstorms can interfere with the reception.
<b>Station overload</b>	When you pass a ground-based broadcast repeating tower, a stronger signal may overtake a weaker one and result in the audio system muting.

## CD and CD Player Information

**Note:** *CD units play commercially pressed 4.7 in (12 cm) audio compact discs only. Due to technical incompatibility, certain recordable and re-recordable compact discs may not function correctly when used in the vehicle's CD player.*

**Note:** *Do not insert CDs with homemade paper (adhesive) labels into the CD player as the label may peel and cause the CD to become jammed. You should use a permanent felt tip marker rather than adhesive labels on your homemade CDs. Ballpoint pens may damage CDs. Ask an authorized dealer for more information.*

**Note:** *Do not use any irregularly shaped discs or discs with a scratch protection film attached.*

Always handle discs by their edges only. Clean the disc with an approved CD cleaner only. Wipe it from the center of the disc toward the edge. Do not clean in a circular motion.

Do not expose discs to direct sunlight or heat sources for extended periods.

# Audio System

## MP3 and WMA Track and Folder Structure

Audio systems capable of recognizing and playing MP3 and WMA individual tracks and folder structures work as follows:

- There are two different modes for MP3 and WMA disc playback: MP3 and WMA track mode (system default) and MP3 and WMA folder mode.
- MP3 and WMA track mode ignores any folder structure on the MP3 and WMA disc. The player numbers each MP3 and WMA track on the disc (noted by the MP3 or WMA file extension) from T001 to a maximum of T255. The maximum number of playable MP3 and WMA files may be less depending on the structure of the CD and exact model of radio present.
- MP3 and WMA folder mode represents a folder structure consisting of one level of folders. The CD player numbers all MP3 and WMA tracks on the disc (noted by the MP3 or WMA file extension) and all folders containing MP3 and WMA files, from F001 (folder) T001 (track) to F253 T255.
- Creating discs with only one level of folders helps with navigation through the disc files.

If you are burning your own MP3 and WMA discs, it is important to understand how the system reads the structures you create. While various files may be present (files with extensions other than MP3 and WMA), only files with the MP3 and WMA extension are played; other files are ignored by the system. This enables you to use the same MP3 and WMA disc for a variety of tasks on your work computer, home computer and your in-vehicle system.

In track mode, the system displays and plays the structure as if it were only one level deep (all MP3 and WMA files play, regardless of being in a specific folder). In folder mode, the system only plays the MP3 and WMA files in the current folder.

## AUDIO UNIT - VEHICLES WITHOUT: SYNC 3

### Switching the Audio Unit On and Off

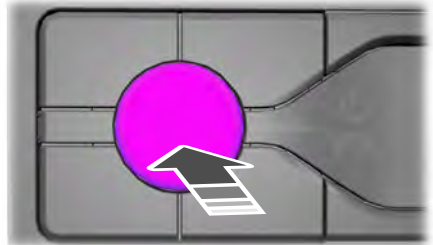

E280686

### Adjusting the Volume



E248939

# Audio System

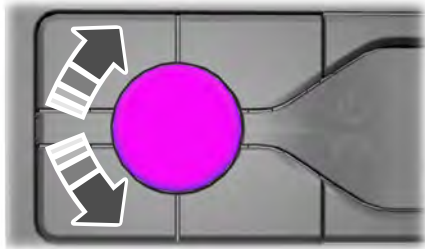

E260697

## Selecting the Radio



Press the button to select radio mode.

Press the button again to display the available radio sources. Repeatedly press the button to scroll through the available radio sources.

## Changing Radio Stations

### Manual Tuning

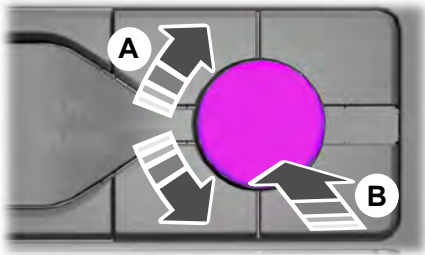

E260687

- A Tune by station list or tune by frequency.
- B Station list tuning.



E248947

**Note:** You can change radio stations using the seek buttons.

**Note:** You can recall radio stations using the numeric preset buttons.

## Selecting Media



Press the button to select media mode.

Press the button again to display the available media sources. Repeatedly press the button to scroll through the available media sources.

# Audio System

## Scrolling Through the Menu Options



E248947

## Selecting a Menu Option



E248946

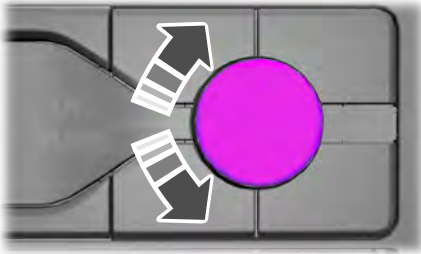

E260782

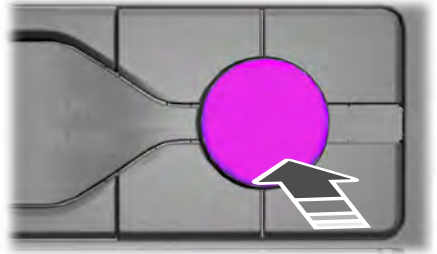

E260781

# Audio System

## Returning to the Previous Screen



## Seek Up and Next Track Button



## Seek Down and Previous Track Button



## Pausing or Playing Media



In media mode, press the button to pause playback. Press the button again to resume playback.

In radio mode, press the button to mute the radio. Press the button again to unmute.

## Switching the Screen On and Off



## System Settings



## Sound Settings



Press the button to adjust the sound settings. You can optimize the sound for different seating positions.

You can also activate and set the sensitivity of the speed compensated volume.

## Using a Cell Phone



You can make a call from a recent call list, contact list or dial a number.

## AUDIO UNIT - VEHICLES WITH: SYNC 3

### Switching the Audio Unit On and Off



### Adjusting the Volume



E248939



# Audio System

## Changing Radio Stations

### Manual Tuning



E270235

**Note:** You can change radio stations using the seek buttons.

**Note:** You can recall radio stations using the numeric preset buttons.

### Scrolling Through the Menu Options



E270235

### Seek Up and Next Track Button



Select to skip to the next track. Press and hold the button to fast forward through the track.

### Seek Down and Previous Track Button



Select to return to the beginning of a track.

Repeatedly press the button to return to previous tracks.

Press and hold the button to fast rewind.

### Pausing or Playing Media



Select to play a track. Press the button again to pause the track.

In radio mode, press the button to mute the radio. Press the button again to unmute.

### Switching the Screen On and Off



### Sound Settings



Press the button to adjust the sound settings. You can optimize the sound for different seating positions.

You can also activate and set the sensitivity of the speed compensated volume.

# Audio System

## AM/FM RADIO - VEHICLES WITHOUT: SYNC 3

### Selecting a Radio Source



Press the button to display the available radio sources.

Repeatedly press the button to scroll to the desired radio source.

Press the **OK** button.

### Station Presets

To store a radio station, press and hold one of the numeric preset buttons.

**Note:** Six presets can be stored for each radio source.

### Manually Changing Radio Stations



E248947

Rotate the control to change the frequency.

### Automatically Changing Radio Stations



Press to seek the next station up the frequency band.

Press and hold to quickly seek up the frequency band.



Press to seek the next station down the frequency band.

Press and hold to quickly seek down the frequency band.

### Selecting a Station from the List

Press the **OK** button to view available stations.

## AUDIO UNIT CLOCK AND DATE DISPLAYS - VEHICLES WITHOUT: SYNC 3

### Adjusting the Clock



Press the button.

Select the clock and follow the instructions on the screen.

## CONNECTING A BLUETOOTH DEVICE - VEHICLES WITHOUT: SYNC 3

### Pairing a Device



Press the button.

Select Bluetooth and follow the instructions on the screen.

**Note:** When pairing a new device, you can choose to download contacts, set this as the primary device and enable Emergency Assistance.

# Audio System

## SATELLITE RADIO

SiriusXM® Satellite Radio broadcasts a variety of music, news, sports, weather, traffic and entertainment satellite radio channels. For more information and a complete list of SiriusXM satellite radio

channels, visit [www.siriusxm.com](http://www.siriusxm.com) in the United States, [www.siriusxm.ca](http://www.siriusxm.ca) in Canada, or call SiriusXM at 1-888-539-7474.

**Note:** *This receiver includes the eCos real-time operating system. eCos is published under the eCos License.*

## Satellite Radio Reception Factors

Potential satellite radio reception issues	
Antenna obstructions	For optimal reception performance, keep the antenna clear of snow and ice build-up and keep luggage and other material as far away from the antenna as possible.
Terrain	Hills, mountains, tall buildings, bridges, tunnels, freeway overpasses, parking garages, dense tree foliage and thunderstorms can interfere with your reception.
Station overload	When you pass a ground-based broadcast-repeating tower, a stronger signal may overtake a weaker one and the audio system may mute.
Satellite radio signal interference	Your display may show ACQUIRING . . . to indicate the interference and the audio system may mute.

## SiriusXM Satellite Radio Service

**Note:** *SiriusXM reserves the unrestricted right to change, rearrange, add or delete programming including canceling, moving or adding particular channels, and its prices, at any time, with or without notice to you. Ford Motor Company shall not be responsible for any such programming changes.*



E208625

# Audio System

SiriusXM satellite radio is a subscription-based satellite radio service that broadcasts a variety of music, sports, news, weather, traffic and entertainment programming. Your factory-installed SiriusXM satellite radio system includes hardware and a limited subscription term, which begins on the date of sale or lease of your vehicle. See an authorized dealer for availability.

For more information on extended subscription terms (a service fee is required), the online media player and a complete list of SiriusXM satellite radio channels, and other features, please visit [www.siriusxm.com](http://www.siriusxm.com) in the United States, [www.siriusxm.ca](http://www.siriusxm.ca) in Canada, or call SiriusXM at 1-888-539-7474.

## Satellite Radio Electronic Serial Number (ESN)

You need your ESN to activate, modify or track your satellite radio account. When in satellite radio mode, tune to channel 0.

## Troubleshooting

Message	Condition	Action
Acquiring...	Radio requires more than two seconds to produce audio for the selected channel.	No action required. This message should disappear shortly.
Satellite antenna fault SIRIUS system failure	There is an internal module or system failure present.	If this message does not clear shortly, or with an ignition key cycle, your receiver may have a fault. See an authorized dealer for service.
Invalid Channel	The channel is no longer available.	Tune to another channel or choose another preset.
Unsubscribed Channel	Your subscription does not include this channel.	Contact SiriusXM at 1-888-539-7474 to subscribe to the channel, or tune to another channel.
No Signal	The signal is lost from the SiriusXM satellite or SiriusXM tower to your vehicle antenna.	The signal is blocked. When you move into an open area, the signal should return.
Updating...	Update of channel programming in progress.	No action required. The process may take up to three minutes.

# Audio System

Message	Condition	Action
Questions? Call 1-888-539-7474	Your satellite service is no longer available.	Contact SiriusXM at 1-888-539-7474 to resolve subscription issues.
None found Check Channel Guide	All the channels in the selected category are either skipped or locked.	Use the channel guide to turn off the Lock or Skip function on that station.
Subscription Updated	SiriusXM has updated the channels available for your vehicle.	No action required.

## STREAMING BLUETOOTH AUDIO - VEHICLES WITHOUT: SYNC 3

### Selecting a Bluetooth Source



Press the button to display the menu.

Repeatedly press the button to scroll to the Bluetooth device.

Press the **OK** button.



Press the button to play the track. Press the button again to pause the track.



Press the button to skip to the next track.

Press and hold the button to fast forward through the track.



Press the button once to return to the beginning of the track. Repeatedly press the button to return to previous tracks.

Press and hold the button to fast rewind.

**Note:** *Not all functions are supported by all phones.*

## PLAYING MEDIA FROM A USB DEVICE - VEHICLES WITHOUT: SYNC 3

### Supported Audio File Formats

You can play audio file formats including MP3, WMA, WAV, M4A, M4B, AAC, and FLAC.

**Note:** *The NTFS file system is not supported.*

### Selecting the USB Device



Press the button to display the menu.

Repeatedly press the button to scroll to your USB device.

Press the **OK** button.

### Playing from the USB Device



Press the button to play a track. Press the button again to pause the track.



Press the button to skip to the next track.

Press and hold the button to fast forward through the track.

# Audio System

---



Press the button once to return to the beginning of a track. Repeatedly press the button to return to previous tracks.

Press and hold the button to fast rewind.

## Sorting by Categories

You can also sort and play music by specific categories, for example artist or album.

Press the **OK** button to view the available categories.

## USB PORT - VEHICLES WITHOUT: SYNC 3

The USB port is on the center console below the gearshift lever.

You can use the USB port to charge a device only when the engine is running.

## USING VOICE RECOGNITION

### Phone Voice Service

This system allows you to use the voice recognition features of your phone and focus on your driving.



Press and hold the voice control button on the steering wheel.

**Note:** This only works when connected via Bluetooth. See **Connecting a Bluetooth Device** (page 358).

**Note:** When using voice recognition use the language set on the device.

# SYNC™ 3

## GENERAL INFORMATION



**WARNING:** Driving while distracted can result in loss of vehicle control, crash and injury. We strongly recommend that you use extreme caution when using any device that may take your focus off the road. Your primary responsibility is the safe operation of your vehicle. We recommend against the use of any hand-held device while driving and encourage the use of voice-operated systems when possible. Make sure you are aware of all applicable local laws that may affect the use of electronic devices while driving.

## Getting to Know Your System

The SYNC 3 system allows you to interact with a variety of features using the touchscreen and voice commands. By integrating with your Bluetooth-enabled phone, the touchscreen provides easy interaction with audio, multimedia, climate control, navigation, and your phone's SYNC 3 compatible apps.

### Using the Touchscreen

To operate the touchscreen, you can simply touch the item or option that you want to select. The button changes color when you select it.

The SYNC 3 layout allows you to quickly select the feature you wish to use.



E207614

E

# SYNC™ 3

Item	Menu Item	Action and Description
A	Status Bar	This bar displays icons and messages pertaining to current system activities including climate settings, voice commands and phone functions such as text messages.
B	Home	This button is available on the main screens. Pressing it takes you to the home screen view.
C	Clock	This shows the current time. You can set the clock manually or have it controlled by the vehicle's GPS location. See <b>Settings</b> (page 386).
D	Outside Temperature	This displays the current outside temperature.
E	Feature Bar	You can touch any of the buttons on this bar to select a feature.

The touchscreen allows you quick access to all of your comfort, navigation, communication and entertainment options. Using the status and feature bar you can quickly select the feature you want to use.

**Note:** *Your system is equipped with a feature that allows you to access and control audio features for 10 minutes after you switch the ignition off (and no doors open).*

## The Status Bar

Additional icons also display in the status bar depending on market, vehicle options and current operation. If a feature is not active, the icon does not display. Certain icons may move to the left or right depending on what options are active.



# SYNC™ 3

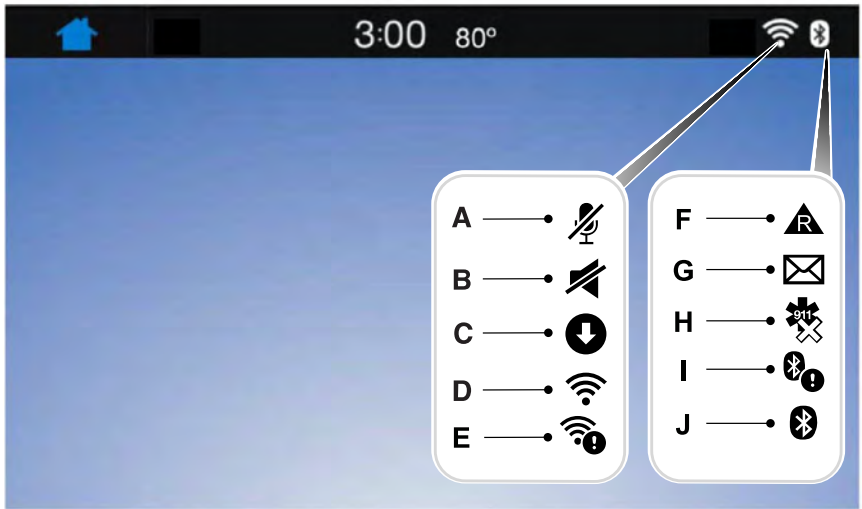

E223058

Callout	Item	Description
A	Microphone Mute	This icon displays when your phone's microphone is muted. A caller cannot hear you.
B	Mute	This icon displays when the audio system is muted.
C	Download	This icon displays when SYNC 3 has received a software update. Pressing the icon will show more details about the new software.
D	Wi-Fi	This icon appears if a Wi-Fi network is connected.
E	Wi-Fi in Range	This icon displays when an available Wi-Fi network is within range.
F	Roaming	This icon displays when your cell phone is roaming.
G	Text Message	This icon displays when you receive a text message on your phone.

# SYNC™ 3

Callout	Item	Description
H	911 Assist Off	This icon displays when 911 Assist is set to off and your phone is connected to SYNC.
I	Bluetooth Alert	This icon displays when there is an active Bluetooth alert.
J	Bluetooth	This icon displays to show an active Bluetooth connection.

Messages may also appear in the status bar to provide you with notifications. You can select the message to view the associated feature.

## Feature Bar

Feature Bar Item	Functions
Audio	Allows you to control the media playing in your vehicle. You can control all audio features including AM, FM and satellite radio, CDs, and media streaming over a Bluetooth device or through a USB connection.
Phone	Allows you to make calls, receive calls, and access the phonebook of your connected device.
Navigation (If equipped)	Allows you to see your vehicle's location on a virtual road map, get driving directions to your destination and find points of interest along your route.
Apps	Connect and control SYNC 3 compatible apps running on your iPhone or Android device. Also, access built-in additional features such as SiriusXM Traffic and Travel Link (if equipped).
Settings	You can customize your system with various settings for the touchscreen display, feature preferences, and how you want to interact with your vehicle.

## Cleaning the Touchscreen

You can remove fingerprints with a dry, clean, soft cloth.

If dirt or fingerprints are still on the screen, apply a small amount of alcohol to the cloth and try to clean it again.

**Note:** Do not use detergent or any type of solvent to clean the touchscreen.

**Note:** Do not pour or spray alcohol onto the touchscreen.

## Using Voice Recognition

Using voice commands allows you to keep your hands on the wheel and focus on what is in front of you. The system provides feedback through audible tones, prompts, questions and spoken confirmations depending on the situation and the chosen level of interaction (voice settings).

The system also asks short questions (confirmation prompts) when it is not sure of your request or when there are multiple possible responses to your request.

When using voice commands, words and icons may appear in the status bar indicating the status of the voice command session. See **Using Voice Recognition** (page 372).

## Using the Steering Wheel Controls

Depending on your vehicle and option package, you can use different controls on your steering wheel to interact with the touchscreen system in different ways.

**VOL:** Control the volume of audio output.

**Mute:** Mute the audio output.

**Voice:** Press to start a voice session. Press again to stop the voice prompt and immediately begin speaking. Press and hold to end a voice session.

## SEEK NEXT:

- While in radio mode, press to seek between memory presets.
- While in USB, Bluetooth Audio or CD mode, press to seek between songs or press and hold to fast seek.

## SEEK PREVIOUS:

- While in radio mode, press to seek between memory presets.
- While in USB, Bluetooth Audio or CD mode, press to seek between songs or press and hold to fast seek.

**PHONE ACCEPT:** Press to answer a call or switch between calls.

**PHONE REJECT:** Press to end a call or reject an incoming call.

**Note:** On some models, **SEEK NEXT** may be combined with **PHONE REJECT** and **SEEK PREVIOUS** may be combined with **PHONE ACCEPT**.

**M:** Touch the control repeatedly to switch between media sources (modes).

See **Steering Wheel** (page 74).

## Using Your Bezel Controls

Depending on your vehicle and option package, you may also have these controls on your instrument panel:

- **Power:** Switch the audio system on and off.
- **VOL:** Control the volume of playing audio.
- **Seek** and **Tune:** as you normally would in audio modes.
- **Eject:** Eject a CD from the audio system.
- **SOURCE** or **MEDIA:** Press repeatedly to advance through available media modes.

# SYNC™ 3

- **SOUND:** Press to access the Sound menu where you can adjust sound and other audio settings.
- **1-6:** Press and hold to store or press to select an AM, FM or SIRIUS memory preset. See **Audio System** (page 352).
- **DISP:** Switch the display on or off. You can also touch the screen to switch the display back on.
- **Temperature, fan and climate control buttons:** Control the temperature, fan speed or settings of the climate control system. See **Climate Control** (page 108).
- Do not leave playing devices in your vehicle during extreme conditions as it could cause them damage. See your device's user guide for further information.
- For your safety, some SYNC 3 functions are speed-dependent. Their use is limited to when your vehicle is traveling at speeds under 3 mph (5 km/h). Make sure that you review your device's manual before using it with SYNC 3.

## Speed-restricted Features

Some features of this system may be too difficult to use while your vehicle is moving so they are restricted from use unless your vehicle is stationary.

- Screens crowded with information, such as Point of Interest reviews and ratings, SiriusXM Traffic and Travel Link sports scores, movie times or ski conditions.
- Any action that requires you to use a keyboard is restricted, such as entering a navigation destination or editing information.
- All lists are limited so the user can view fewer entries (such as phone contacts or recent phone call entries).

See the following chart for more specific examples.

## Safety Information



**WARNING:** Driving while distracted can result in loss of vehicle control, crash and injury. We strongly recommend that you use extreme caution when using any device that may take your focus off the road. Your primary responsibility is the safe operation of your vehicle. We recommend against the use of any hand-held device while driving and encourage the use of voice-operated systems when possible. Make sure you are aware of all applicable local laws that may affect the use of electronic devices while driving.

- Do not attempt to service or repair the system. Have an authorized dealer check your vehicle.
- Do not operate playing devices if the power cords or cables are broken, split or damaged. Place cords and cables out of the way, so they do not interfere with the operation of pedals, seats, compartments or safe driving abilities.

# SYNC™ 3

<b>Restricted features</b>	
Cellular Phone	Pairing a Bluetooth phone.
	Browsing of list entries is limited for phone contacts and recent phone calls.
System Functionality	Editing the keypad code.
	Enabling Valet Mode.
	Editing settings while the rear view camera or active park assist are active.
Wi-Fi	Editing Wi-Fi settings.
	Editing the list of wireless networks.
	Connecting to a new Wi-Fi network.
Text Messages	Viewing received text messages.
Navigation	Using the keyboard to enter a destination.
	Adding or editing Navigation Favorites entries or Avoid Areas.

## Creating a SYNC Owner Account

Why do I need a SYNC owner account?

- Essential for keeping up with the latest software and connected features.
- Access to customer support for any questions you may have.
- Maintain account permissions.

Visit the website to sign up and register.

<b>Website</b>
<a href="http://www.owner.ford.com">www.owner.ford.com</a> <a href="http://www.syncmyride.ca">www.syncmyride.ca</a>

<b>Website</b>
<a href="http://www.syncmaroute.ca">www.syncmaroute.ca</a>

## Updating Your System

You can choose to download the update onto a USB drive or use Wi-Fi to deliver automatic updates.

### USB Updates

To use the USB update you need to log into your owner account and visit the SYNC software update page.

<b>Website</b>
<a href="http://www.owner.ford.com">www.owner.ford.com</a> <a href="http://www.syncmyride.ca">www.syncmyride.ca</a>

# SYNC™ 3

Website
www.syncmaroute.ca

The website notifies you if an update is available. You can then select to download the update.

You will need an empty USB drive. Please check the website for minimum requirements. Once you have inserted the USB drive into your computer, choose to start the download. Follow the instructions provided to download the files to the USB drive.

The installation of most files occurs in the background, and does not interrupt your use of the system. Navigation updates cannot be installed in the background, because the files are too large.

To install the update in your vehicle, remove anything that is plugged in the USB ports on the media hub and plug in the USB drive containing the update. When the USB drive is plugged in, the installation should begin immediately. After a successful installation, the update is available the next time the vehicle is started.

Please refer to the website for any further actions.

## Updating Over Wi-Fi

To update your System over Wi-Fi your vehicle must be within the range of a Wi-Fi access point. Data rates may apply.

## To connect your system to Wi-Fi, select:

Menu Item	
Settings	
Wi-Fi	
Available Wi-Fi Networks	You can then select your Wi-Fi network. You may have to enter the security code if the network is secured. The system confirms when it has connected to the network.

You must also give the system permission to update automatically. Upon vehicle delivery, the System asks you if you would like to use the automatic update feature. If you agree to automatic updates, you can press OK to confirm. If this selection does not appear upon vehicle delivery you can access it through the General Settings. See **Settings** (page 386). You can also perform a master reset. See **SYNC™ 3 Troubleshooting** (page 400).

## If you would like to switch this feature on later, select:

Menu Item	
Settings	
General	
Automatic System Updates	From this menu, you can enable automatic updates. If you have not done so already, the system prompts you to set up a Wi-Fi connection when you enable this feature.

When Wi-Fi and automatic updates are enabled, your system checks for software updates periodically. If a new version is available, it downloads at that time. Software downloads can take place for up to 30 minutes after you have switched your vehicle off. The updates do not interrupt the normal use of your SYNC 3 system. If a download does not complete for any reason, the download continues where it left off at the next Wi-Fi connected opportunity. Upon activation of an update, a banner displays on the touchscreen indicating the system update. Select the icon to see more detail. This icon displays for two ignition cycles.

### To switch this feature off:

Menu Item	
Settings	
General	
Automatic System Updates	In this menu selection, you can change the selection for automatic updates to OFF.

### Support

The SYNC support team is available to help you with any questions you are not able to answer on your own.

Monday–Saturday, 8:30am–8:00pm EST.

United States: 1-800-392-3673.

Canada: 1-800-565-3673.

Times are subject to change due to holidays.

### Privacy Information

When you connect a cellular phone to SYNC 3, the system creates a profile within your vehicle that links to that cellular phone. This profile helps in offering you more cellular features and operating more efficiently. Among other things, this profile may contain data about your cellular phone book, text messages (read and unread), and call history, including history of calls when your cell phone was not connected to the system. In addition, if you connect a media device, the system creates and retains an index of supported media content. The system also records a short diagnostic log of approximately 10 minutes of all recent system activity. The log profile and other system data may be used to improve the system and help diagnose any problems that may occur.

The cellular profile, media device index, and diagnostic log remain in your vehicle unless you delete them and are generally accessible only in your vehicle when the cellular phone or media player is connected.

If you no longer plan to use the system or your vehicle, we recommend you perform a Master Reset to erase all stored information. You can find more information about the Master Reset in General Settings. See **Settings** (page 386). System data cannot be accessed without special equipment and access to your vehicle's SYNC 3 module. Ford Motor Company and Ford of Canada do not access the system data for any purpose other than as described absent consent, a court order, or where required by law enforcement, other government authorities, or other third parties acting with lawful authority. Other parties may seek to access the information independently of Ford Motor Company and Ford of Canada.

## HOME SCREEN

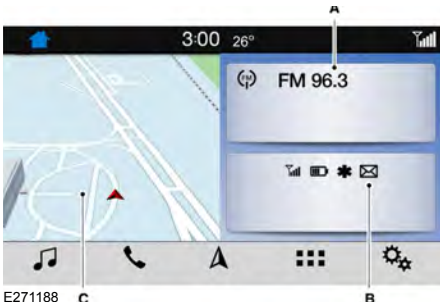

- A See **Entertainment** (page 377).
- B See **Phone** (page 379).
- C See **Navigation** (page 381).



Press the voice control button on the steering wheel and wait for the voice prompt.

**Note:** Press the voice control button again to interrupt a voice prompt and begin speaking.

**Note:** Turn the volume control when a voice prompt plays to adjust the volume.

**Note:** Press and hold the voice control button on the steering wheel to use Siri on your iOS device.

The following voice commands are designed to help you from any screen:

- **List of Commands**
- **Help**

The following tables list some of the more frequently used voice commands. For a complete list of voice commands, refer to the regional Ford website.

## USING VOICE RECOGNITION

The system allows you to interact with the entertainment, information and communication systems on your vehicle using voice commands. This allows you to keep your hands on the steering wheel and focus on what is in front of you.

### General

Voice Command	Description
___ List of Commands	Get a list of voice commands for a specific feature. <sup>1</sup>
Cancel	Cancel an active voice session.
___ Help	Get a list of voice commands for a specific feature. <sup>1</sup>
Go back	Return to the previous screen.
Main Menu	Go to the main menu.



# SYNC™ 3

Voice Command	Description
Next Page	Go to the next page.
Previous Page	Go to the previous page.

<sup>1</sup> Add the name of the feature to the command.

## Entertainment

### Audio Source

Voice Command	Description
Radio	Use the radio.
CD Player	Use the CD player.
Bluetooth Stereo	Use a Bluetooth device.
USB	Use a USB or media player.

### Radio

Voice Command	Description
AM	Listen to AM radio.
AM ____	Tune to a specific AM frequency. <sup>1</sup>
DAB	Listen to DAB radio.
FM	Listen to FM radio.
FM ____	Tune to a specific FM frequency. <sup>1</sup>

<sup>1</sup> Add the radio frequency to two decimal places to the command.

# SYNC™ 3

## USB and Media Player

Voice Command	Description
Browse All Albums	Browse your music.
Browse All Artists	
Browse All Audiobooks	
Browse All Genres	
Browse All Playlists	
Browse All Podcasts	
Browse All Songs	
Browse Album ____	Browse your music by category. <sup>1</sup>
Browse Artist ____	
Browse Audiobook ____	
Browse Genre ____	
Browse Playlist ____	
Browse Podcast ____	
Play Album ____	Play your music by category. <sup>1</sup>
Play Artist ____	
Play Genre ____	
Play Playlist ____	
Play Song ____	

<sup>1</sup> Add an album name, artist name, audiobook name, genre name, playlist name, podcast name or track name to the command. Say the name exactly as it appears on your device.

## Phone

Voice Command	Description
Pair Phone	Pair a cell phone or Bluetooth enabled device.
Redial	Redial the last number that you dialed.
Dial ____	Dial a number. <sup>1</sup>

# SYNC™ 3

Voice Command	Description
Call ___	Call a specific contact from your phonebook. <sup>2</sup>
Call ___ ___	Call a specific contact from your phonebook at a specific location. <sup>3</sup>
Listen to Message	Listen to a text message.
Listen to Message ___	Listen to a specific text message from a list of text messages.
Reply to Message	Reply to the last text message.

<sup>1</sup> Add the number you want to dial to the command.

<sup>2</sup> Add a contact name from your phonebook to the command. Say the first and last name of your contact exactly as it appears on your device.

<sup>3</sup> Add a contact name and location from your phonebook to the command. Say the first and last name of your contact exactly as it appears on your device.

## Navigation (If Equipped)

### Setting a Destination

Voice Command	Description
Find an Address	Enter a destination address. When prompted, provide the house number, the street and city.
Find a POI	Search for a point of interest by name or by category.
Destination Nearest ___	Search for a nearby point of interest by category. <sup>1</sup>
Find a POI Category	Search for a point of interest category. <sup>1</sup>
Drive Home	Set your saved home address as your destination.
Drive to Work	Set your saved place of work as your destination.
Show Previous Destinations	Display and select from a list of previous destinations.
Show Favorites	Display and select from a list of favorite destinations.

<sup>1</sup> Add a point of interest name or category to the command.

# SYNC™ 3

## Route Guidance

Voice Command	Description
Cancel Route	Cancel the current route.
Detour	Select an alternate route.
Repeat Instruction	Repeat the last guidance prompt.
Show Route	Display an overview of the route.
Show Traffic	Display a list of traffic events on your route.
Show All Traffic	Display a list of all traffic events.
Show Map	Display the map on the touchscreen.
North Up	Display a two-dimensional map with north toward the top of the touchscreen.
Heading UP	Display a two-dimensional map with the direction you are traveling toward the top of the touchscreen.
Show 3D	Display a three-dimensional map with the direction you are traveling toward the front.

## Apps

### General

Voice Command	Description
Mobile Applications	Start an app. The system prompts your for the app name.
List Applications	Get a list of apps running on your device.
Find Applications	Search and connect to apps running on your device.

### Active App

Voice Command	Description
___ Help	Get a list of voice commands for a specific app. <sup>1</sup>
Exit ___	Close an app. <sup>1</sup>

<sup>1</sup> Add an app name to the command.

## Voice Settings

Voice Command	Description
Voice Settings	Go to the voice settings menu.
Interaction Mode Novice	Switch long voice prompts on.
Interaction Mode Advanced	Switch short voice prompts on.
Phone Confirmation On	Switch call confirmation on. The system prompts you to confirm before making a call.
Phone Confirmation Off	Switch call confirmation off. The system does not prompt you to confirm before making a call.
Voice Command Lists On	Display the display of voice commands on.
Voice Command Lists Off	Switch the display of voice commands off.

## Automatic Blower Motor Speed Reduction

If necessary, the system decreases the blower motor speed when you are using voice commands to reduce the amount of background noise in your vehicle. It returns to normal when you are finished.

## Switching Automatic Blower Motor Speed Reduction Off

Simultaneously press the **A/C** and recirculated air buttons.

## ENTERTAINMENT



Select the entertainment option on the feature bar.

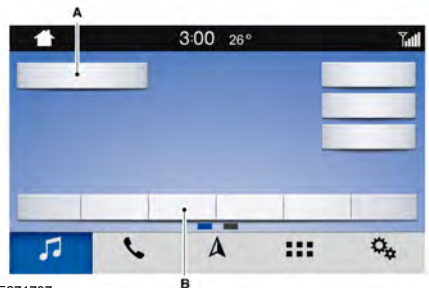

E271797

- A Audio source. Select to choose a different audio source.
- B Presets. Swipe left to view more presets.

## Using the Radio

### Setting a Radio Station Using the Touchscreen

#### Directly Tuning a Radio Station

Select **Sources**.

Select **AM** or **FM**.

Select **Frequency**.

Enter the frequency of the radio station and select **Enter**.

**Note:** You must enter the frequency to two decimal places.

## Selecting a Radio Station From a List

Select **Sources**.

Select **FM** or **DAB**.

Select **Station**.

Select a radio station from the list.

## Switching Traffic Announcements On

Select **Traffic (TA)**.

**Note:** If you switch traffic announcements on, traffic announcements broadcast by radio stations interrupt the current audio source to help you plan your route.

## Storing a Radio Station

You can use the different sets of presets to allow different drivers to store their favorite radio stations.

Set a radio station.

Select **Presets**.

**Note:** Only do this if you wish to select a different set of presets.

Press and hold one of the preset buttons.

**Note:** The radio briefly mutes to indicate the radio station has been stored.

## Streaming Music From a Bluetooth Device

Check the compatibility of your device on the regional Ford website.

Pair your device. See **Phone** (page 379).

Select **Sources**.



Select **Bluetooth**.

## Searching for Tracks on a Bluetooth Device

Select **Browse**.

Select a track.

**Note:** Select the cover art to view information about the current track.

## Repeating Tracks on a Bluetooth Device



Select the repeat icon to repeat tracks.

**Note:** You can repeat one track or all tracks on an audio format Bluetooth device. You can repeat one track, all tracks or all tracks in one folder on a Bluetooth device.

**Note:** A small number one appears next to the repeat icon to indicate that a track is set to repeat. A small folder icon appears next to it to indicate that a folder is set to repeat

## Playing Tracks on a Bluetooth Device in a Random Order



Select to play tracks in a random order.

## Playing Music From a USB or Media Player

Connect your device to a USB port.

Select **Sources**.



Select **USB**.

**Note:** The system indexes your music before you can play it.

## Searching for Tracks on a USB or Media Player

Select **Browse**.

Select a track.

**Note:** Select the cover art to view information about the current track.

**Note:** You can also browse by album, artist, audiobook, genre, playlist, podcast or track name.

## Repeating Tracks on a USB or Media Player



Select the repeat icon to repeat tracks.

**Note:** You can repeat one track or all tracks on an audio format USB or media player. You can repeat one track, all tracks or all tracks in one folder on a USB or media player.

**Note:** A small number one appears next to the repeat icon to indicate that a track is set to repeat. A small folder icon appears next to it to indicate that a folder is set to repeat

## Supported Devices

The system supports most USB and media players, including iOS and Android devices.

## Supported File Formats

The system supports the following file formats:

- MP3, MP4, WMA, WAV, AAC, AIFF, APE, DSD, and FLAC audio file formats.
- MP3, WMA, WAV, M4A, M4B, AAC, and FLAC file extensions.
- FAT, exFAT, and NTFS file systems.

## Audio File Metadata

The system organizes files on your USB or media player by metadata tags. Metadata tags contain information about the file. If the metadata tags for the files on your USB or media player contain no information, the system classifies them as unknown. The system can index up to 50000 tracks on a USB device or media player, and up to 10 devices.

## PHONE



**WARNING:** Driving while distracted can result in loss of vehicle control, crash and injury. We strongly recommend that you use extreme caution when using any device that may take your focus off the road. Your primary responsibility is the safe operation of your vehicle. We recommend against the use of any hand-held device while driving and encourage the use of voice-operated systems when possible. Make sure you are aware of all applicable local laws that may affect the use of electronic devices while driving.

Check the compatibility of your device on the regional Ford website.

## Pairing Your Cell Phone for the First Time

Go to the settings menu on your cell phone and switch Bluetooth on.



Select the phone option on the feature bar.

Select **Add Phone**.

**Note:** A prompt alerts you to search for your vehicle on your cell phone.

Select your vehicle on your cell phone.

**Note:** A number appears on your cell phone and on the touchscreen.

Confirm that the number on your cell phone matches the number on the touchscreen.

**Note:** The touchscreen indicates that you have successfully paired your cell phone.

Download the phonebook from your cell phone when you are prompted.

**Note:** *If you pair more than one cell phone, use the phone settings to specify the primary phone. You can change this setting at any time.*

## Using Your Cell Phone

### Recent Call List

Display and select an entry from a list of previous calls.

### Contacts

Alphabetically sort your contacts. See **Settings** (page 386).

### Phone Settings

Change ring tones, alerts or pair another phone.

### Do Not Disturb

Reject incoming calls and switch ring tones and alerts off.

### Phone Keypad

Directly dial a number.

## Using Text Messaging

Menu Item	Description
Hear It	Hear the text message.
View	View the text message.
Call	Call the sender.
Reply	Reply to the text message with a standard text message.

## Apple CarPlay

Connect your device to a USB port.  
Follow the instructions on the touchscreen.

**Note:** *Certain features of the system are not available when you are using Apple CarPlay.*

## Mute

Mute your cell phone microphone.

## Text Messaging

### Setting Text Message Notification

#### iOS

1. Go to the settings menu on your cell phone.
2. Select Bluetooth.
3. Select the information icon to the right of your vehicle.
4. Switch text message notification on.

#### Android

1. Go to the settings menu on your cell phone.
2. Select Bluetooth.
3. Select the profiles option.
4. Select the phone profile .
5. Switch text message notification on.

## Switching Apple CarPlay Off



Select the settings option on the feature bar.

Select **Apple CarPlay Preferences**.

Select **Disable** from the dropdown menu.



# SYNC™ 3

## Android Auto

Connect your device to a USB port.

Follow the instructions on the touchscreen.

**Note:** You might need to enable Android Auto from the settings menu.

**Note:** Certain features of the system are not available when you are using Android Auto.

## Switching Android Auto Off



Select the settings option on the feature bar.

Select **Android Auto**.

Select **Disable** from the dropdown menu.

## NAVIGATION

**Note:** For more information, refer to the regional Ford website.

## Setting a Destination

### Destination Entry Menu

Item	Description
Search	Enter a destination address.
Previous Destinations	Display and select from a list of previous destinations.
Home	Set your saved home address as your destination
Work	Set your saved place of work as your destination.
Favorites	Display and select from a list of favorite destinations.



Select the navigation option on the feature bar.

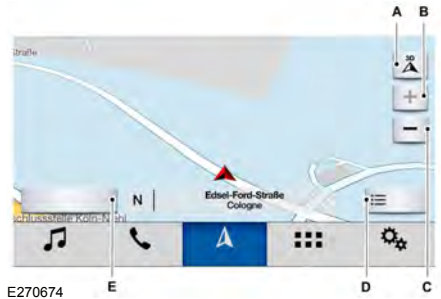

- A Map view menu.
- B Zoom in.
- C Zoom out.
- D Route guidance menu.
- E Destination entry menu.

## Setting a Destination Using the Text Entry Screen

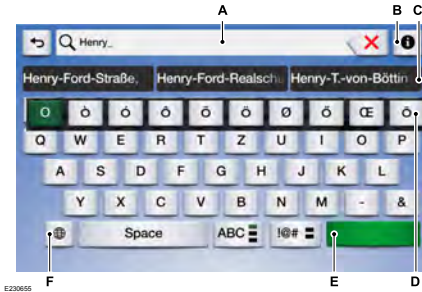

- A Text entry field.
- B Information icon.
- C Automatic suggestions based on the text you enter.
- D Extended keyboard.
- E Search.
- F Keyboard settings.

**Note:** Select one of the suggestions to copy the detail to the text entry field.

You can search by entering all or part of the destination, such as the Address, POI Category or Name, Intersection, City, Latitude/Longitude, etc. **Tips:** If you do not specify a location, the system will use the current vehicle location. You can specify a location by address, city, state or zip code. For additional search support, please visit: [support.ford.com](http://support.ford.com).

**Note:** Press the button in the top right-hand corner of the main map to display estimated time of arrival, remaining travel time or distance to destination.

## Setting a Destination Using the Map Screen

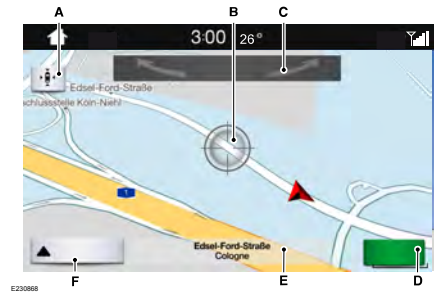

- A Re-center the map.
- B Selected location.
- C 3D map rotation. Swipe left or right.
- D Start route guidance.
- E Destination name.
- F Show feature bar.

Select the location on the map.

Select **Start** to begin route guidance.

## Changing the Format of the Map

Display the map in one of the following formats:

- A two-dimensional map with the direction you are traveling toward the top of the screen.
- A two-dimensional map with north toward the top of the screen.
- A three-dimensional map with the direction you are traveling toward the front.

## Zoom

Display more or less detail on the map.

**Note:** You can use pinch gestures to zoom in and out. Place two fingers on the screen and move them apart to zoom in. Place two fingers on the screen and bring them together to zoom out.

## Route Guidance

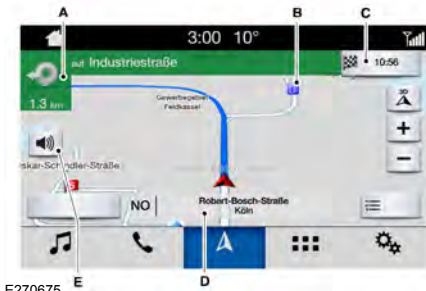

E270675

- A Turn indicator. Select to hear the last voice prompt.
- B Point of interest.

- C Estimated time of arrival, distance to destination or time to destination.
- D Current road.
- E Mute guidance prompts.

**Note:** To change guidance prompt volume, turn the volume control when a guidance prompt plays.

## Route Guidance Menu

Menu Item	Description
Screen View	Adjust your map preferences for when route guidance is active.
Full Map	View a full screen map when route guidance is active.
Highway Exit Info	View highway exit information for your current route.
Turn List	View the turn list for your current route. Select a road to avoid it.
Traffic List	View traffic nearby or on your current route. <sup>1</sup>
Navigation Settings	Adjust navigation settings. See <b>Settings</b> (page 386).
Where Am I?	View information about your current location.
Cancel Route	Cancel route guidance.
View Route	View the entire current route on the map.
Detour	View an alternative route compared to your current one.

# SYNC™ 3

Menu Item	Description
Edit Waypoints	Change the order or remove waypoints.
Optimize Order	The system determines the order of waypoints for you.
Go	Go to the next screen and start the new route.

<sup>1</sup> Reliant upon traffic message channel or live traffic.

## Adjusting the Guidance Prompt Volume

Turn the volume control when a guidance prompt plays to adjust the volume.

**Note:** *If you have inadvertently adjusted the volume to zero, press the turn indicator button to play the last voice prompt and then adjust the volume to the desired level.*

## Muting Guidance Prompts



Select the mute option on the screen to mute guidance prompts.

**Note:** *The system mutes the next and all future guidance prompts.*

## Adding Waypoints

You can add a waypoint to a navigation route as a destination along your route. You can add up to five waypoints.

1. Select the search option on the map.
2. Set a destination.
3. Select **Add Waypoint**.
4. Select **Go**.

## Canceling Route Guidance



Select the route guidance menu option on the active guidance screen.

Select **Cancel Route**.

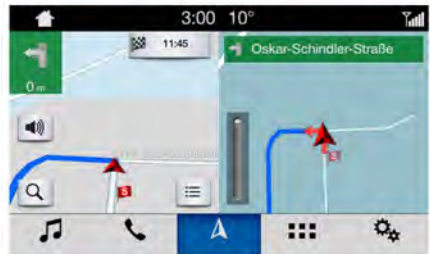

E270676

**Note:** *The route guidance menu option is always in the bottom right-hand corner of the main map.*

## Live Traffic

Live traffic provides near real-time traffic information to help you plan the fastest route to your destination. You must have an active subscription for Live Traffic.



E270955

- A Traffic congestion.
- B Traffic incident.
- C Urgent warning.

## Switching Live Traffic On

**Note:** Before you begin, enable the modem using the FordPass app. See **General Information** (page 363).



Select the settings option on the feature bar.

1. Select **SYNC Connect**.
2. Select **Connectivity Settings**.
3. Switch **Connectivity Features** on
4. Switch **Location** on.
5. Switch **Vehicle data & Remote ctrl** on.
6. Switch **Live Traffic** on.

## Michelin Travel Guide (If Equipped)

The Michelin travel guide is a service which provides additional information about certain places of interest, for example restaurants, hotels and tourist sites. Points of interest that have Michelin travel guide information display a button to show you

more information. Push the button to see the additional information. If you have paired your phone with the system, you can press the phone button to directly establish a call with the selected point of interest.

## Navigation Map Updates

HERE is the digital map provider for the navigation application. If you find map data errors, you may report them directly to HERE by going to [www.here.com](http://www.here.com). HERE evaluates all reported map errors and responds with the result of their investigation by e-mail.

## APPS

**Note:** For more information about available apps, refer to the regional Ford website.

When you start an app through the system for the first time, you could be asked to grant certain permissions. You can review and change the permissions that you have granted at any time when your vehicle is not moving. See **Settings** (page 386).

**Note:** We recommend that you check your data plan before using your apps through the system. Using them could result in additional charges.

**Note:** We recommend that you check the app provider's terms and conditions and privacy policy before using their app.

**Note:** Make sure that you have an active account for apps that you want to use through the system.

**Note:** Some apps will work with no setup. Others require you to configure some personal settings before you can use them.

## Using Apps on an iOS Device



Select the apps option on the feature bar.

# SYNC™ 3

1. Switch Apple CarPlay off. See **Phone** (page 379).
2. Connect your device to a USB port.
3. Start the apps on your device that you want to use through SYNC.

**Note:** If you close the apps on your device, you will not be able to use them through the system.

4. Select **Find Mobile Apps**.

**Note:** The system searches and connects to compatible apps that are running on your device.

5. Select the app that you want to use on the touchscreen.

## Using Apps on an Android Device



Select the apps option on the feature bar.

1. Switch Android Auto off. See **Phone** (page 379).
2. Pair your device. See **Phone** (page 379).

3. Start the apps on your device that you want to use through SYNC.

**Note:** If you close the apps on your device, you will not be able to use them through the system.

4. Select **Find Mobile Apps**.

**Note:** The system searches and connects to compatible apps that are running on your device.

5. Select the app that you want to use on the touchscreen.

## SETTINGS

Under this menu, you can access and adjust the settings for many of the system features. To access additional settings, swipe the screen left or right.

### Sound

Pressing this button allows you to adjust the following:

Sound Settings	
Reset All	Returns Treble, Midrange, and Bass sound settings to factory levels.
Treble	Adjusts the high frequency level.
Midrange	Adjusts the middle frequency level.
Bass	Adjusts the low frequency level.
Balance / Fade	Adjusts the sound ratio from side to side or front to back.
Speed Compensated Vol.	Adjusts the amount the audio system volume increases with speed, or turns the feature off.
Occupancy Mode	Optimizes the sound based on the location of the listeners.
Sound Settings	Stereo
	Surround

Your vehicle might not have all of these features.

# SYNC™ 3

## Media Player

This button is available when a media device such as a Bluetooth Stereo or USB

device is the active audio source. Pressing the button allows you to access the following options for active devices only.

Menu Item	Action and Description		
Podcast Speed	For some USB devices, SYNC 3 can adjust the playback speed of podcasts. When a podcast is playing, you can choose:		
	Slower	Normal	Faster
Audiobook Speed	For some USB devices, SYNC 3 can adjust the playback speed of audiobooks. When an audiobook is playing, you can choose:		
	Slower	Normal	Faster
Cover Art Priority	Media Player	Cover art displays from your device's music files. If no cover art for the files exists on the device, then the Gracenote Database provides cover art.	
	Gracenote®	The Gracenote Database supplied cover art is used for your music files. This overrides any cover art from your device.	
Gracenote® Management	Switches on and off Gracenote® to provide metadata information such as genre, artist, album.		
Gracenote® Database Info	This allows you to view the version level of the Gracenote Database.		
Device Information	This allows you to view the manufacturer and model number of your media device.		
Update Media Index	Erase the stored in media information in order to re-index.		

## Clock

You can adjust the following features:

To adjust the time, select the up and down arrows on either side of the screen. The arrows on the left adjust the hour and arrows on the right adjust the minute. You can then select AM or PM.

# SYNC™ 3

Menu Item	Action and Description
Clock Format	Select how time displays.
Auto Time Zone Update	When active, the clock adjusts to time zone changes. This feature is only available in vehicles with navigation.
Reset Clock to GPS Time	When selected, the vehicle clock resets to GPS satellite time.

The system automatically saves any updates you make to the settings.

## Bluetooth

Pressing this button allows you to access the following:

Menu Item	Action
Bluetooth	Turning Bluetooth off disconnects all devices and does not permit new connections.

You must activate Bluetooth to pair a Bluetooth-enabled device.

The processes of pairing a Bluetooth device is the same as pairing a phone. **See Pairing a Device** in Phone settings for how to pair a device and the available options.

## Phone

Pair your Bluetooth-enabled phone with the system before using the functions in hands-free mode.

Switch on Bluetooth on your device to begin pairing. See your phone's manual if necessary.

### To add a phone, select:

Menu Item
Add Phone

1. Follow the on-screen instructions.
2. A prompt alerts you to search for the system on your phone.

3. Select your vehicle's make and model as it displays on your phone.
4. Confirm that the six-digit number appearing on your phone matches the six-digit number on the touchscreen.
5. The touchscreen indicates when the pairing is successful.
6. Your phone may prompt you to give the system permission to access information. To check your phone's compatibility, see your phone's manual or visit the website.

### Alternatively, to add a phone, select:

Menu Item
Add Phone
<b>Then select:</b>
Discover Other Bluetooth Devices

1. Follow the on-screen instructions.
2. Select your phone's name when it appears on the touchscreen.



# SYNC™ 3

3. Confirm that the six-digit number appearing on your phone matches the six-digit number on the touchscreen.
4. The touchscreen indicates when the pairing is successful.
5. Your phone may prompt you to give the system permission to access information. To check your phone's compatibility, see your phone's manual or visit the website.

**To check your phone's compatibility, see your phone's manual or visit the website:**

Website
<a href="http://owner.ford.com">owner.ford.com</a> <a href="http://www.syncmyride.ca">www.syncmyride.ca</a> <a href="http://www.syncmaroute.ca">www.syncmaroute.ca</a>

Other features, such as text messaging using Bluetooth and automatic phonebook download, are phone-dependent features.

Once you have paired a device you can adjust the following options.

Menu Item	Action and Description
View Devices	
<b>You can then select:</b>	
Add a Bluetooth Device	You can add a Bluetooth-enabled device by following the steps in the previous table.
You can select a phone by touching the name of the phone on the screen. You then have the following options:	
Connect	Depending on the status of the device, you can select either of these options to interact with the selected device.
Disconnect	
Make Primary	Allows you to select this device to be your preferred device.
Delete	Removes the selected device from the system.

Pressing the info icon next to the device name allows you to see phone and device information

Menu Item	Action and Description
Manage Contacts	
<b>You can then select:</b>	
Auto-Download Contacts	Enable this option to have SYNC 3 periodically re-download your phonebook to keep your contact list up to date.
Sort By:	Choose how you would like the system to display your contacts. You can choose:

# SYNC™ 3

Menu Item	Action and Description	
	First Name	Last Name
Re-download Contacts	Select this option to re-download your contact list manually.	
Delete Contacts	Select this option to delete the in vehicle contact list. Deleting the in vehicle list does not erase the contact list on the connected phone.	

Menu Item	Action and Description	
Set Phone Ringtone		
<b>You can then select:</b>		
No Ringtone	No sound plays when a call comes to your phone.	
Use Phone Ringtone	The currently selected ringtone on your phone plays when you receive a call. This option may not be available for all phones. If this option is available, it is the default setting.	
You can also select one of the three available ringers.		

Menu Item	Action and Description	
Text Messaging		
<b>You can then select:</b>		
No Alert (Silence)	No sound plays when a message comes to your phone.	
You can select one of the three available notification sounds.		
Voice Readout	When enabled, a voice prompt alerts you when you receive a new message.	

# SYNC™ 3

**You can enable and disable the following options as well:**

<b>Menu Item</b>	<b>Action and Description</b>
Mute Audio in Privacy	When enabled, vehicle audio (such as radio or apps) is muted for the duration of the phone call even when the phone call is in privacy.
Roaming Warning	When enabled, an alert displays that your phone is roaming when you attempt to place a call.
Low Battery Notification	When enabled, a message displays when the battery on your phone is running low.

## **911 Assist**

**Note:** *This service is only available in the United States and Canada.*

Select this button to modify the on or off setting for this feature. If the mobile phone's contacts have been downloaded, you can adjust the following option:

<b>Menu Item</b>	<b>Action and Description</b>
Set Emergency Contacts	You can select up to two numbers from your mobile device's phone-book as emergency contacts for quick access at the end of the 911 Assist call process.

## **Radio**

This button is available if a Radio source such as AM or FM is the active media source. Pressing the button allows you to access the following features:

# SYNC™ 3

Menu Item	Action and Description
FM HD Radio AM HD Radio (Dependent on current radio source, If Available)	Activation of this feature allows you to listen to HD radio broadcasts.
Radio Text	This feature is available when FM Radio is your active media source. Activate this feature to have the system display radio text.
Autoset Presets (AST)	Refresh Selecting this option stores the six strongest stations in your current location to the last preset bank of the currently tuned source.

## Sirius XM (If equipped)

Menu Item	Action and Description
Set Category for Seek	After selecting a category, seek function only stops on channels which are inside that selected category.
Parental Lockout	Select to create a personal identification number (PIN). This allows you to lock or unlock channels. Your initial PIN is 1234.
Edit Alerts	Select to switch on, off or delete alerts.

The Electronic Serial Number can also be found on this screen. This number is necessary to activate, modify or track your account through Sirius XM.

## Navigation

You can adjust many of the Navigation preferences by selecting the following menus.

# SYNC™ 3

## Map Preferences

Menu Item	Action and Description	
Map Preferences		
<b>Then select any of the following:</b>		
3D City Model	When this option is active, the system shows 3D renderings of buildings.	
Breadcrumbs	When enabled, your vehicle's previously traveled route displays with white dots.	
POI Icons	Enable this feature to display up to 3 POI icons on the navigation map. A rest area POI icon may display on the map regardless of this setting.	
	Once this feature is activated you can select the icons you want displayed by selecting:	Select POIs
Incident Map Icons	This menu allows you to choose which incident icons you would like to have displayed on the navigation map.	

## Route Preferences

Menu Item	Second Level Messages, Actions and Descriptions		
Route Preferences			
<b>Then select any of the following:</b>			
Preferred Route	Choose to have the system display your chosen route type.		
	Shortest	Fastest	Eco
Always Use ____ Route	Bypass route selection in destination programming. The system only calculates one route based on your preferred route setting. When activated, the system uses your selected route type to calculate only one route to the desired destination.		
Use HOV Lanes	The system selects High Occupancy Vehicle or car pool lanes when providing route guidance.		
Automatically Find Parking	The system searches for and displays available parking locations as you approach your destination.		
Eco Time Penalty	Select a level of cost for the calculated Eco Route. The higher the setting, the longer the time allotment is for the route.		

# SYNC™ 3

Menu Item	Second Level Messages, Actions and Descriptions
Dynamic Route Guidance	Enable or disable considering traffic information when planning a route. The system can find a faster route based on heavy traffic flow information or detect a Road Closed incident and find a detour route if possible.
Avoid Freeways	If selected, SYNC 3 avoids freeways when computing a navigation route.
Avoid Toll Roads	If selected, SYNC 3 avoids Toll Roads when computing a navigation route.
Avoid Ferries/Car Trains	If selected, SYNC 3 avoids the use of Ferries or Trains when computing a navigation route.

## Navigation Preferences

Menu Item	Action and Description
Navigation Preferences	
Guidance Prompts	You can adjust how the system provides prompts.
<b>Then select any of the following:</b>	
Voice and Tones	A tone sounds followed by voice instructions.
Voice Only	Only voice instructions are given.
Tones Only	Only a tone sounds to prompt you.

## Mobile Apps

You can enable the control of compatible mobile apps running on your Bluetooth or USB device on SYNC 3. In order to enable mobile apps, SYNC 3 requires user consent to send and receive app authorization information and updates using the data plan associated with the connected device.

The connected device sends data to Ford in the United States. The encrypted information includes your VIN, SYNC 3 module number, anonymous usage statistics and debugging information. Updates may take place automatically.

**Note:** *All Mobile Apps may not be compatible with the system.*

# SYNC™ 3

**Note:** Standard data rates will apply. Ford is not responsible for any additional charges you may receive from your service provider, when your vehicle sends or receives data through the connected device. This includes any additional charges incurred due to driving in areas when roaming out of a home network.

Menu Item	Action and Description		
Mobile Apps	Enable or disable the use of mobile apps on SYNC 3. Disabling mobile apps in the settings menu disables automatic updates and the use of mobile apps on SYNC 3.		
	You can view the status of mobile app permissions in the settings menu.		
Once Mobile Apps is enabled, you have the following options:			
Update Mobile Apps	This provides information on the current state of available app updates.		
	There are three possible statuses:		
	Update Needed	Up-To-Date	Updating Mobile Apps...
	The system has detected a new app requiring authorization or a general permissions update is required.	No update is required.	The system is trying to receive an update.
	Request Update		Select this button if an update is required and you want to request this update manually. For example, when your mobile device is connected to a Wi-Fi hotspot, select:

# SYNC™ 3

Menu Item	Action and Description
	Request Update
All Apps	Grant or deny permissions to all apps at once.
There may also be SYNC 3 enabled apps listed under these options.	Grant or deny an individual app particular permissions. App permissions are organized into groups. By pressing the info book icon, you can see which signals are included in each group.

**Note:** Ford is not responsible or liable for any damages or loss of privacy relating to usage of an app, or dissemination of any vehicle data that you approve Ford to provide to an app.

## General

Access and adjust the system settings, voice features, as well as phone, navigation and wireless settings.

Menu Item	
Language	Select to have the touchscreen display in English, Spanish or French.
Distance	Select to display units in kilometers or miles.
Temperature	Select to display units in Celsius or Fahrenheit.
Touch Panel Beep	Select to have the system beep to confirm choices made through the touchscreen.
Automatic System Updates	When you activate this option, the system automatically updates when you have an available Internet connection through a Wi-Fi network or mobile connection.
About SYNC	Information pertaining to the system and its software.
Software Licenses	Documentation of the software license for the system.
Master Reset	Select to restore factory defaults. This erases all personal settings and personal data.

## Wi-Fi & Hotspot

Access SYNC Wi-Fi and Vehicle Hotspot settings and information.

## System Wi-Fi

You can access the following:



# SYNC™ 3

Menu Item	Action and Description
Wi-Fi	Enable this option to connect to Wi-Fi for SYNC 3 vehicle software updates.
Available Networks	This provides you with a list of available Wi-Fi networks within range.
	Clicking on a network from the list allows you to connect or disconnect from that network. The system may require a security code to connect.
	When you click the information button next to a network, more information about the network displays such as the signal strength, connection status and security type.
Wi-Fi Available Notifications	The system alerts you when your vehicle is parked and a Wi-Fi network is within range if SYNC is not already connected.

## Vehicle Hotspot (If Equipped)

You can access the following:

Menu Item	Action and Description
Wi-Fi Hotspot On/Off	Allows you to turn the hotspot on and off.
Settings	Allows you to view and edit hotspot settings such as the SSID and password.
Data Usage	Allows you to view your vehicle's hotspot plan and data usage.
Manage Devices	Allows you to manage devices connected to your hotspot.

**Note:** *The Vehicle Wi-Fi Hotspot (Vehicle Hotspot) may be operational while ignition is On and may remain operational while the ignition is Off.*

**Note:** *Vehicle Hotspot services are provided by the vehicle network carrier, subject to your vehicle network carrier agreement, coverage and availability.*

**Note:** *It is the account owner's responsibility to remove the vehicle from the vehicle network carrier account when ownership of the vehicle is transferred. If the owner would like to remove the vehicle from the account for any reason, please contact your vehicle network carrier for more information.*

**Note:** : Data, e.g. the Vehicle Identification Number (VIN), SIM Card ID, and data plan usage, is shared between Ford and the vehicle network carrier to provide the Vehicle Hotspot service in accordance with your vehicle network carrier agreement, coverage and availability, and may be used to enable a seamless transition from an old to new embedded modem and to confirm any updates are successfully delivered.

**Note:** : For your convenience data usage may be available for monitoring under Settings but may not reflect actual or current usage. The vehicle network carrier is responsible for providing information about your account. Please contact the vehicle network carrier for more information.

**Note:** : Ford may need to update operating system software on your vehicle, including security updates and bug fixes, to keep connected services current, like Vehicle Hotspot, without prior notice to you.

**Note:** If you do not have an active vehicle hotspot data plan, open your web browser and go to a website using the HTTP protocol to be automatically redirected to the vehicle network carrier landing page where you can purchase data. Websites using HTTPS will not automatically redirect.

## Camera Settings

To make adjustments using the touchscreen, select:

Message	Action and Description
Camera Settings	
<b>Then select from the following:</b>	
Enhanced Park Aids	When the reverse sensing system detects an object, it displays red, yellow and green highlights at the top of the image.
Rear Camera Delay	You can enable or disable this option using the slider.

You can find more information on the rear-view camera system in the parking aids chapter of your owner manual.

## Ambient Lighting (If Equipped)

Tap a color once to active ambient lighting. This sets the color to the highest intensity.

You can drag the colors up and down to increase or decrease the intensity.

To switch ambient lighting off, press the active color once or drag the active color all the way down to zero intensity.

## Vehicle

**Note:** Your vehicle may not have all of these features.

You can select the following features to update their settings.

## Door Keypad Code (If equipped)

Select this button to add or erase a personal door keypad code. To add or erase a personal code, you first need to enter the five-digit factory set code. You can find this code on the owner's wallet card in the glove box or from your authorized dealer.

# SYNC™ 3

## Onboard Modem Serial Number (ESN)

Selecting this button on the settings menu

shows you the ESN number for your system. You need this number for certain registrations such as Satellite Radio.

## Display

**To make adjustments using the touchscreen, select:**

Menu Item	Action and Description	
Brightness	Make the screen display brighter or dimmer.	
Mode	You can select:	
	Auto	The screen automatically switches between day and night modes based on the outside light level.
	Day	The screen displays with a light background to enhance daytime viewing.
	Night	The screen displays with a darker background to make nighttime viewing easier.
	Off	The screen goes black and does not display anything. To switch the screen back on, simply tap the screen.
Auto Dim	Enable this option to automatically dim the display brightness based on ambient lighting conditions.	

## Voice Control

You can adjust the voice control settings by selecting the following options.

Menu Item	
Advanced Mode	Enable this option to remove additional voice prompts and confirmations.
Phone Confirmation	Enable this option to have the system confirm a contacts name with you before making a call.
Voice Command List	Enable this option to have the system display a list of available voice commands when the voice button is pressed.

# SYNC™ 3

## Valet Mode

Valet mode allows you to lock the system. No information is accessible until the system is unlocked with the correct PIN.

When you select valet mode a pop up appears informing you that a four digit code must be entered to enable and disable valet mode. You can use any PIN you chose but you must use the same PIN to disable valet mode. The system asks you to input the code.

**Note:** *If the system is locked and you cannot remember the PIN, please contact the Customer Relationship Center.*

United States: 1-800-392-3673

Canada: 1-800-565-3673

To enable valet mode, enter your chosen PIN. The system then asks to confirm your PIN by reentering it. The system then locks.

To unlock the system, enter the same pin number. The system reconnects to your phone and all of your options are available again.

## SYNC™ 3 TROUBLESHOOTING

Your SYNC 3 system is easy to use. However, should questions arise, please refer to the tables below.

To check your cell phone's compatibility, visit the Ford website.

Website
<a href="http://owner.ford.com">owner.ford.com</a> <a href="http://www.syncmyride.ca">www.syncmyride.ca</a> <a href="http://www.syncmaroute.ca">www.syncmaroute.ca</a>

Cell phone issues		
Issue	Possible cause	Possible solution
There is background noise during a phone call.	The audio control settings on your cell phone may be affecting SYNC 3 performance.	Refer to your device's manual about audio adjustments.
During a call, I can hear the other person but they cannot hear me.	Possible cell phone malfunction.	Try switching your cell phone off, resetting it or removing the battery, then try again.
		Make sure that the microphone for SYNC 3 is not set to off. Look for the microphone icon on the phone screen.
During a call, I cannot hear the other person and they cannot hear me.	The system may need to be restarted.	To restart your system, shut down the engine, open and close the door, and then lock the door and wait for 2-3 minutes. Make sure that your SYNC 3 screen is black and the lighted USB port is off.
SYNC 3 is not able to download my phonebook.	This is a cell phone-dependent feature.	Check your cell phone's compatibility.

# SYNC™ 3

<b>Cell phone issues</b>		
<b>Issue</b>	<b>Possible cause</b>	<b>Possible solution</b>
	Possible cell phone malfunction.	Make sure you allow SYNC 3 to retrieve contacts from your phone. Refer to your cell manual.
		You must switch on your cell phone and the automatic phonebook download feature on SYNC 3.
		Try switching your cell phone off, resetting it or removing the battery, then try again.
The system says "Phonebook downloaded" but my SYNC 3 phonebook is empty or is missing contacts.	Limitations on your cell phone's capability.	Make sure you allow SYNC 3 to retrieve contacts from your phone. Refer to your cell manual.
		If the missing contacts are stored on your SIM card, move them to your cell phone's memory.
		You must switch on your cell phone and the automatic phonebook download feature on SYNC 3.
I am having trouble connecting my cell phone to SYNC 3.	This is a cell phone-dependent feature.	Check your cell phone's compatibility.
	Possible cell phone malfunction.	Try switching your cell phone off, resetting it or removing the battery, then try again.
		Try deleting your device from SYNC 3 and deleting SYNC from your device, then trying again.
		Always check the security and auto accept prompt settings relative to the SYNC 3 Bluetooth connection on your cell phone.
		Update your cell phone's firmware.
		Switch the auto download setting off.
Text messaging is not working on SYNC 3.	This is a cell phone-dependent feature.	Check your cell phone's compatibility.
	Possible cell phone malfunction.	Try switching your cell phone off, resetting it or removing the battery, then try again.

# SYNC™ 3

Cell phone issues		
Issue	Possible cause	Possible solution
	iPhone	<ul style="list-style-type: none"> <li>• Go to your cell phone's Settings.</li> <li>• Go to the Bluetooth Menu.</li> <li>• Press the blue circle to the right of the device named with your vehicle make and model to enter the next menu.</li> <li>• Turn Show Notifications on.</li> <li>• Disconnect then reconnect your iPhone from the SYNC 3 system to activate this settings update.</li> </ul> <p>Your iPhone is now set up to forward incoming text messages to SYNC 3. Repeat these steps for every other SYNC 3 vehicle that you connect. Your iPhone will only forward incoming text messages to SYNC 3 if the iPhone is not unlocked in the messaging application. Replying to text messages using SYNC 3 is not supported by iPhone. Text messages from WhatsApp and Facebook Messenger are not supported.</p>
Audible text messages do not work on my cell phone.	This is a cell phone-dependent feature.	Your cell phone must support downloading text messages through Bluetooth to receive incoming text messages.
	This is a cell phone limitation.	Because each cell phone is different, refer to your device's manual for the specific cell phone you are pairing. In fact, there can be differences between cell phones due to brand, model, service provider and software version.

# SYNC™ 3

USB and Bluetooth Stereo issues		
Issue	Possible cause	Possible solution
I am having trouble connecting my device.	Possible device malfunction.	Disconnect the device from SYNC 3. Try switching your device off, resetting it or removing the battery, then reconnect it to SYNC 3.
		Make sure you are using the manufacturer's cable.
		Make sure to correctly insert the USB cable into the device and your vehicle's USB port.
	The device has a lock screen enabled.	Make sure that the device does not have an auto-install program or active security settings.
SYNC 3 does not recognize my device when I start my vehicle.	The device has a lock screen enabled.	Make sure your device is unlocked before connecting it to SYNC 3.
Bluetooth audio does not stream.	This is a device-dependent feature.	Make sure you are not leaving the device in your vehicle during very hot or cold temperatures.
	The device is not connected.	
SYNC 3 does not recognize music that is on my device.	Your music files may not contain the correct artist, song title, album or genre information.	Make sure you connect the device to SYNC 3 and that you have started the media player on your device.
	The file may be corrupted.	Make sure that all song details are populated.
	The song may have copyright protection that does not allow it to play.	Try replacing the corrupt file with a new version.
	The file format is not supported by SYNC 3.	Some devices require you to change the USB settings from mass storage to media transfer protocol class.
		Convert the file to a supported format. See <b>Entertainment</b> (page 377).

# SYNC™ 3

USB and Bluetooth Stereo issues		
Issue	Possible cause	Possible solution
	The device needs to be re-indexed.	Update media index. See <b>Settings</b> (page 386).
	The device has a lock screen enabled.	Make sure your device is unlocked before connecting it to SYNC 3.
When I connect my device, I sometimes do not hear any sound.	This is a device limitation.	Disconnect the device from SYNC 3. Try switching your device off, resetting it or removing the battery, then connect it back to SYNC 3.
		To listen to Apple devices through USB, select AirPlay from the devices Control Center, then select Dock Connector.
		To listen to Apple devices through Bluetooth Stereo, select AirPlay from the devices Control Center, then select SYNC.

Wi-Fi Issues		
Issue	Possible cause	Possible solution
Failed connection.	Password error.	Verify password.
	Weak signal.	Check for a poor Wi-Fi signal.
	Multiple Access points within range with the same SSID.	Use a unique name for your SSID, don't use the default name unless it contains a unique identifier, such as part of the MAC address.
Disconnecting after successful connection.	Weak signal probably due to distance from the hotspot, obstruction or high interference.	Position the vehicle close to the hotspot with the front of the vehicle facing the hotspot direction and remove obstacles if possible. Other Wi-Fi, Bluetooth, microwave and cordless phones may cause interference.



# SYNC™ 3

<b>Wi-Fi Issues</b>		
<b>Issue</b>	<b>Possible cause</b>	<b>Possible solution</b>
Poor signal seen by SYNC 3 despite being near a hotspot.	There may be an obstruction between SYNC 3 and the hotspot.	If the vehicle is equipped with heated windshield, try positioning the vehicle so that the windshield is not facing the hotspot. If you have metallic window tinting but not on the windshield, position the vehicle to face the hotspot. If all windows are tinted, you can open the windows in the direction of the hotspot if that is feasible. Try to remove other obstructions that may impact signal quality such as opening the garage door.
A hotspot is not listed in the list of available networks.	The hotspot was defined as a hidden network.	Please set the network to visible and try again.
SYNC 3 is not seen when searching for Wi-Fi networks from your phone or other devices.	SYNC 3 does not currently provide a hotspot.	SYNC 3 currently does not provide a hotspot
Software download takes too long.	Poor signal strength, too far from the hotspot, hotspot is supporting multiple connections, slow Internet connection or other problems.	Check the signal quality (under network details), if SYNC 3 indicates good or excellent, test with another high-speed equipped hotspot where the environment is more predictable.
SYNC 3 seems to connect with a hotspot and the signal strength is excellent but the software is not being updated.	It is possible that there is no new software. The connected hotspot may be a managed one and it requires either a subscription or agreeing to the terms and conditions.	Test the connection with another device, if the hotspot requires a subscription, you may contact the service provider.

# SYNC™ 3

<b>AppLink issues</b>		
<b>Issue</b>	<b>Possible cause(s)</b>	<b>Possible solution(s)</b>
AppLink Mobile Applications: When I select "Connect Mobile Apps," SYNC 3 does not find any applications.	You did not connect an AppLink Compatible phone to SYNC 3.	Make sure you have a compatible smartphone; an Android with OS 2.3 or higher or an iPhone 3GS or newer with iOS 5.0 or higher. Additionally, make sure you pair and connect your phone to SYNC 3 in order to find AppLink-capable apps on your device. iPhone users must also connect to a USB port with an Apple USB cable.
My phone is connected, but I still cannot find any apps.	AppLink-enabled apps are not installed and running on your mobile device.	Make sure you have downloaded and installed the latest version of the app from your phone's app store. Make sure the app is running on your phone. Some apps require you to register or login to the app on the phone before using them with AppLink. Also, some may have a "Ford SYNC" setting, so check the app's settings menu on the phone.
My phone is connected, my app(s) are running, but I still cannot find any apps.	Sometimes apps do not properly close and re-open their connection to SYNC 3, over ignition cycles, for example.	Closing and restarting apps may help SYNC 3 find the application if you cannot discover it inside the vehicle. On an Android device, if apps have an 'Exit' or 'Quit' option, then select it and restart the app. If the app does not have that option, select the phone's settings menu and select 'Apps',

# SYNC™ 3

<b>Applink issues</b>		
<b>Issue</b>	<b>Possible cause(s)</b>	<b>Possible solution(s)</b>
		then find the particular app and choose 'Force stop.' Do not forget to restart the app afterward, then select "Connect Mobile Apps" on SYNC 3.
		On an iPhone with iOS7+, to force close an app, double tap the home button then swipec up on the app to close it. Tap the home button again, then select the app again to restart it. After a few seconds, the app should then appear in SYNC 3's Mobile App's Menu.
My Android phone is connected, my app(s) are running, I restarted them, but I still cannot find any apps.	There is a Bluetooth issue on some older versions of the Android operating system that may cause apps that were found on your previous vehicle drive to not be found again if you did not switch Bluetooth off.	Switch Bluetooth off and then on to reset it on your phone. If you are in your vehicle, SYNC 3 should be able to automatically re-connect to your phone if you press the "Phone" button.

# SYNC™ 3

<b>AppLink issues</b>		
<b>Issue</b>	<b>Possible cause(s)</b>	<b>Possible solution(s)</b>
My iPhone is connected, my app is running, I restarted the app but I still cannot find it on SYNC 3.	You may need to reset the USB connection to SYNC 3.	Unplug the USB cable from the phone, wait a moment, and plug the USB cable back in to the phone. After a few seconds, the app should appear in SYNC 3's Mobile Apps Menu. If not, "Force Close" the application and restart it.
I have an Android phone. I found and started my media app on SYNC 3, but there is no sound or the sound is very low.	The Bluetooth volume on the phone may be low.	Increase the Bluetooth volume of the device by using the device's volume control buttons which are most often found on the side of the device.
I can only see some of the AppLink apps running on my phone listed in the SYNC 3 Mobile Apps Menu.	Some Android devices have a limited number of Bluetooth ports that apps can use to connect. If you have more AppLink apps on your phone than the number of available Bluetooth ports, you will not see all of your apps listed in the SYNC 3 mobile apps menu.	Force close or uninstall the apps you do not want SYNC 3 to find. If the app has a "Ford SYNC" setting, disable that setting in the app's settings menu on the phone.

<b>Voice command issues</b>		
<b>Issue</b>	<b>Possible cause</b>	<b>Possible solution</b>
SYNC 3 does not understand what I am saying.	You may be using the wrong voice commands.	Review the cell phone voice commands and the media voice commands at the beginning of their respective sections.
	You may be speaking too soon or at the wrong time.	Refer to the audio display during an active voice session to find a list of voice commands there. Wait for the system to prompt you before you state your command.

# SYNC™ 3

Voice command issues		
Issue	Possible cause	Possible solution
SYNC 3 does not understand the name of a song or artist.	You may be using the wrong voice commands.	Review the media voice commands at the beginning of the media section.
	You may not be saying the name exactly as it appears on your device.	Say the song or artist name exactly as it is displayed on your device. For example, say "Play Artist Prince" or "Play song Purple Rain".
		Make sure you are saying the complete title such as "California remix featuring Jennifer Nettles".
		If there are any abbreviations in the name, like ESPN or CNN, you have to spell those: "E-S-P-N" or "C-N-N".
The song or artist name may have some special characters that are not being recognized by SYNC 3.	Make sure that song titles, artists, album, and playlists names do not have any special characters like *, - or +.	
SYNC 3 does not understand or is calling the wrong contact when I want to make a call.	You may not be saying the name exactly as it appears on your phone-book.	Make sure that you are saying the name exactly as it appears on your phone. For example, if your contact is "Joe Wilson", say "Call Joe Wilson". If your contact name is "Mom", say "Call Mom".
	The contact name may contain special characters.	Make sure that your contact names do not have any special characters like *, - or +.
The SYNC 3 voice control system is having trouble recognizing foreign names stored on my cell phone.	You may not be saying the name exactly as it appears on your phone-book.	SYNC 3 applies the phonetic pronunciation rules of the selected language to the contact names stored on your cell phone.
		<b>Helpful Hint:</b> You can select your contact manually. Press <b>PHONE</b> . Select the option for phonebook and then contact name. Press the soft-key option to hear it. SYNC 3 will read the contact name to you, giving you some idea of the pronunciation it is expecting.

# SYNC™ 3

Voice command issues		
Issue	Possible cause	Possible solution
The SYNC 3 voice control system is having trouble recognizing foreign tracks, artists, albums, genres and playlist names from my media player or USB flash drive.	You may be saying the foreign names using the currently selected language for SYNC 3.	SYNC 3 applies the phonetic pronunciation rules of the selected language to the names stored on your media player or USB flash drive. It is able to make some exceptions for very popular artist names (for example, U2) such that you can always use the English pronunciation for these artists.
The system generates voice prompts and the pronunciation of some words may not be accurate for my language.	SYNC 3 uses text-to-speech voice prompt technology.	SYNC 3 uses a synthetically generated voice rather than pre-recorded human voice.
		SYNC 3 offers several new voice control features for a wide range of languages. Dialing a contact name directly from the phonebook without pre-recording (for example, "call John Smith") or selecting a track, artist, album, genre or playlist directly from your media player (for example, "play artist Madonna").

# SYNC™ 3

General		
Issue	Possible cause	Possible solution
The language selected for the instrument cluster and information and entertainment display does not match the SYNC 3 language (phone, USB, Bluetooth audio, voice control and voice prompts).	SYNC 3 does not support the currently selected language for the instrument cluster and information and entertainment display.	SYNC 3 only supports four languages in a single module for text display, voice control and voice prompts. The country where you bought your vehicle dictates the four languages based on the most popular languages spoken. If the selected language is not available, SYNC 3 remains in the current active language.
		SYNC 3 offers several new voice control features for a wide range of languages. Dialing a contact name directly from the phonebook without pre-recording (for example, "call John Smith") or selecting a track, artist, album, genre or playlist directly from your media player (for example, "play artist Madonna").

SYNC 3 System Reset
The system has a System Reset feature that can be performed if the function of a SYNC 3 feature is lost. This reset is intended to restore functionality and will not erase any information previously stored in the system (such as paired devices, phonebook, call history, text messages, or user settings). To perform a System Reset, press and hold the Seek Up (>> ) button while pressing and holding the Radio Power button. After approximately 5 seconds the screen will go black. Allow 1-2 minutes for the system reset to complete. You may then resume using the SYNC 3 system.

For additional assistance with SYNC 3 troubleshooting please call or visit the Ford Website.

Ford Support	
Customer Relationship Center	United States: 1-800-392-3673
	Canada: 1-800-565-3673
Website	owner.ford.com www.syncmyride.ca www.syncmaroute.ca

# Accessories

---

For a complete listing of the accessories that are available for your vehicle, please contact your authorized dealer or visit the online store web site:

<b>Web Address (United States)</b>
------------------------------------

<a href="http://www.Accessories.Ford.com">www.Accessories.Ford.com</a>
--

<b>Web Address (Canada)</b>
-----------------------------

<a href="http://www.Accessories.Ford.ca">www.Accessories.Ford.ca</a>
--

Ford Accessories are available for your vehicle through an authorized Ford dealer. Ford Motor Company will repair or replace any properly authorized dealer-installed Ford Original Accessory found to be defective in factory-supplied materials or workmanship during the warranty period, as well as any component damaged by the defective accessories.

Ford Motor Company warrants your accessory through the warranty that provides the greatest benefit:

- 24 months, unlimited mileage.
- The remainder of your new vehicle limited warranty.

Contact an authorized dealer for details and a copy of the warranty.

## Exterior Style

- Hood deflector\*.
- Hitch and towing accessories.
- Keyless entry.
- Side window deflectors.
- Splash guards.
- Window grilles.

## Interior Style

- All-weather floor mats.
- Cargo area protectors.

- Cargo organizers.
- Carpeted floor mats.
- Interior light kit.

## Lifestyle

- Ash cup and smokers packages.
- Roof racks and carriers\*.
- Telematics\*.
- In-vehicle safe\*.
- Bluetooth speakers\*.
- Rear seat entertainment\*.

## Peace of Mind

- Back-up alarm\*.
- Bumper-mounted parking sensor\*.
- Remote start.
- Roadside assistance kit\*.
- Vehicle security systems.

\*Ford Licensed Accessory. The accessory manufacturer designs, develops and therefore warrants Ford Licensed Accessories, and does not design or test these accessories to Ford Motor Company engineering requirements. Contact an authorized Ford dealer for the manufacturer's limited warranty details, and request a copy of the Ford Licensed Accessories product limited warranty from the accessory manufacturer.



# Accessories

---

For maximum vehicle performance, keep the following information in mind when adding accessories or equipment to your vehicle:

- When adding accessories, equipment, passengers and luggage to your vehicle, do not exceed the total weight capacity of the vehicle or of the front or rear axle (GVWR or GAWR as indicated on the Safety Compliance Certification label). Ask an authorized dealer for specific weight information.
- The Federal Communications Commission (FCC) and Canadian Radio Telecommunications Commission (CRTC) regulate the use of mobile communications systems that are equipped with radio transmitters, for example two-way radios, telephones and anti-theft alarms. Any such equipment installed in your vehicle should comply with Federal Communications Commission (FCC) and Canadian Radio Telecommunications Commission (CRTC) regulations and should be installed only by an authorized dealer.
- Mobile communications systems may harm the operation of your vehicle, particularly if their manufacturer did not design them specifically for automotive use.
- If you or an authorized Ford dealer add any non-Ford custom electrical or electronic accessories or components to your vehicle, you may adversely affect battery performance and durability, and may adversely affect the performance of other electrical systems in the vehicle.

# Ford Protect

---

PROTECT YOURSELF FROM THE RISING COST OF VEHICLE REPAIRS WITH A FORD PROTECT EXTENDED SERVICE PLAN.

## **Ford Protect Extended Service Plans (U.S. Only)**

Ford Protect extended service plan means peace of mind. It's the extended service plan backed by Ford Motor Company, and provides more protection beyond the New Vehicle Limited Warranty coverage. When you visit your Ford Dealer, Insist on Ford Protect extended service plans!

## **Ford Protect Can Quickly Pay for Itself**

One trip to the Service Center could easily exceed the price of your Ford Protect extended service plan. With Ford Protect extended service plan you minimize your risk for unexpected repair bills and rising repair costs.

## **Up to 1,000+ Covered Vehicle Components**

There are four mechanical Ford Protect extended service plans with different levels of coverage. Ask your authorized dealer for details.

1. PremiumCARE - Our most comprehensive coverage. With over 1,000 covered components, this plan is so complete it's probably easier to list what's not covered.
2. ExtraCARE - Covers 113 components, and includes many high-tech items.
3. BaseCARE - Covers 84 components.
4. PowertrainCARE - Covers 29 critical components.

Ford Protect extended service plans are honored by all authorized Ford dealers in the U.S., Canada and Mexico.

That means you get:

- Reliable, quality service at any Ford or Lincoln dealership.
- Repairs performed by factory trained technicians, using genuine parts.

## **Rental Car Reimbursement**

### ***1st day Rental Benefit***

If you bring your car into your dealer for service, we'll give you a loaner to use for the day.

### ***Extended Rental Benefits***

If your vehicle is kept overnight for covered repairs, you are eligible for rental car coverage, including warranty repairs, and Field Service Actions.

## **Roadside Assistance**

Exclusive 24/7 roadside assistance, including:

- Towing, flat-tire change and battery jump starts.
- Out of fuel and lock-out assistance.
- Travel expense reimbursement for lodging, meals and rental car.
- Assistance for taxi, shuttle, rental car coverage or other transportation.

## **Transferable Coverage**

If you sell your vehicle before your Ford Protect extended service plan coverage expires, you can transfer any remaining coverage to the new owner. Which should give you and your potential buyer a little more peace of mind.

# Ford Protect

---

## Less Cost to Properly Maintain Your Vehicle

Ford Protect extended service plan also offers a Premium Maintenance Plan that covers all scheduled maintenance, and selected wear items. The coverage is prepaid, so you never have to worry about the cost of your vehicle's maintenance.

Covered maintenance includes:

- Windshield wiper blades.
- Spark plugs.
- The clutch disc (if equipped).
- Brake pads and linings.
- Shock absorbers.
- Struts.
- Engine Belts.
- Engine coolant hoses, clamps and o-rings.
- Diesel exhaust fluid replenishment (if equipped).
- Cabin air filter replacement every 20,000 mi (32,000 km) (electric vehicles only).

## Interest Free Finance Options

Just a 10% down payment will provide you with an affordable, no interest, no fee payment program allowing you all the security and benefits Ford Protect extended service plan has to offer while paying over time. You are pre-approved with no credit check or hassles. To learn more, call our Ford Protect extended service plan specialists at 800-367-3377.

Ford Protect Extended Service Plan  
P.O. Box 321067  
Detroit, MI 48232

## Ford Protect Extended Service Plan (CANADA ONLY)

You can get more protection for your vehicle by purchasing a Ford Protect extended service plan. Ford Protect extended service plan is the only service contract backed by Ford Motor Company of Canada, Limited. Depending on the plan you purchase, Ford Protect extended service plan provides benefits such as:

- Rental reimbursement.
- Coverage for certain maintenance and wear items.
- Protection against repair costs after your New Vehicle Limited Warranty Coverage expires.
- Roadside Assistance benefits.

There are several Ford Protect extended service plans available in various time, distance and deductible combinations. Each plan is tailored to fit your own driving needs, including reimbursement for towing and rental. When you purchase Ford Protect extended service plan, you receive added peace-of-mind protection throughout Canada, the United States and Mexico, provided by a network of participating authorized Ford Motor Company dealers.

**Note:** *Repairs performed outside of Canada, the United States and Mexico are not eligible for Ford Protect extended service plan coverage.*

This information is subject to change. For more information; visit your local Ford of Canada dealer or [www.ford.ca](http://www.ford.ca) to find the Ford Protect extended service plan that is right for you.

# Scheduled Maintenance

---

## GENERAL MAINTENANCE INFORMATION

### Why Maintain Your Vehicle?

Carefully following the maintenance schedule helps protect against major repair expenses resulting from neglect or inadequate maintenance and may help to increase the value of your vehicle when you sell or trade it. Keep all receipts for completed maintenance with your vehicle.

We have established regular maintenance intervals for your vehicle based upon rigorous testing. It is important that you have your vehicle serviced at the proper times. These intervals serve two purposes; one is to maintain the reliability of your vehicle and the second is to keep your cost of owning your vehicle down.

It is your responsibility to have all scheduled maintenance performed and to make sure that the materials used meet the specifications identified in this owner's manual. See **Capacities and Specifications** (page 327).

Failure to perform scheduled maintenance invalidates warranty coverage on parts affected by the lack of maintenance.

### Why Maintain Your Vehicle at Your Dealership?

#### Factory-Trained Technicians

Service technicians participate in extensive factory-sponsored certification training to help them become experts on the operation of your vehicle. Ask your dealership about the training and certification their technicians have received.

## Genuine Ford and Motorcraft® Replacement Parts

Dealerships stock Ford, Motorcraft and Ford-authorized branded re-manufactured replacement parts. These parts meet or exceed our specifications. Parts installed at your dealership carry a nationwide 24-month or unlimited mile (kilometer) parts and labor limited warranty.

If you do not use Ford authorized parts they may not meet our specifications and depending on the part, it could affect emissions compliance.

### Convenience

Many dealerships have extended evening and Saturday hours to make your service visit more convenient and they offer one stop shopping. They can perform any services that are required on your vehicle, from general maintenance to collision repairs.

**Note:** *Not all dealers have extended hours or body shops. Please contact your dealer for details.*

### Protecting Your Investment

Maintenance is an investment that pays dividends in the form of improved reliability, durability and resale value. To maintain the proper performance of your vehicle and its emission control systems, make sure you have scheduled maintenance performed at the designated intervals.

Your vehicle is equipped with the Intelligent Oil-Life Monitor system, which displays a message in the information display at the proper oil change interval. This interval may be up to one year or 10,000 mi (16,000 km).

# Scheduled Maintenance

---

When the oil change message appears in the information display, it is time for an oil change. Make sure you perform the oil change within two weeks or 500 mi (800 km) of the message appearing. Make sure you reset the Intelligent Oil-Life Monitor after each oil change. See **Oil Change Indicator Reset** (page 267).

If your information display resets prematurely or becomes inoperative, you should perform the oil change interval at six months or 5,000 mi (8,000 km) from your last oil change. Never exceed one year or 10,000 mi (16,000 km) between oil change intervals.

Your vehicle is very sophisticated and built with multiple, complex, performance systems. Every manufacturer develops these systems using different specifications and performance features. That is why it is important to rely upon your dealership to properly diagnose and repair your vehicle.

Ford Motor Company has recommended maintenance intervals for various parts and component systems based upon engineering testing. Ford Motor Company relies upon this testing to determine the most appropriate mileage for replacement of oils and fluids to protect your vehicle at the lowest overall cost to you and recommends against maintenance schedules that deviate from the scheduled maintenance information.

We strongly recommend the use of only genuine Ford, Motorcraft or Ford-authorized re-manufactured replacement parts engineered for your vehicle.

## Additives and Chemicals

This owner's manual and the Ford Workshop Manual list the recommended additives and chemicals for your vehicle. We do not recommend using chemicals or additives not approved by us as part of your vehicle's normal maintenance. Please consult your warranty information.

## Oils, Fluids and Flushing

In many cases, fluid discoloration is a normal operating characteristic and, by itself, does not necessarily indicate a concern or that the fluid needs to be changed. However, a qualified expert, such as the factory-trained technicians at your dealership, should inspect discolored fluids that also show signs of overheating or foreign material contamination immediately.

Make sure to change your vehicle's oils and fluids at the specified intervals or in conjunction with a repair. Flushing is a viable way to change fluid for many vehicle sub-systems during scheduled maintenance. It is critical that systems are flushed only with new fluid that is the same as that required to fill and operate the system or using a Ford-approved flushing chemical.

## Owner Checks and Services

Make sure you perform the following basic maintenance checks and inspections every month or at six-month intervals.

# Scheduled Maintenance

---

<b>Check Every Month</b>
Engine oil level.
Function of all interior and exterior lights.
Tires (including spare) for wear and proper pressure.
Windshield washer fluid level.
Fuel and water separator. Drain if necessary (or if indicated by the information display).
Holes and slots in the tail pipe to make sure they are functional and clear of debris.

<b>Check Every Six Months</b>
Battery connections. Clean if necessary.
Body and door drain holes for obstructions. Clean if necessary.
Cooling system fluid level and coolant strength.
Door weatherstrips for wear. Lubricate if necessary.
Hinges, latches and outside locks for proper operation. Lubricate if necessary.
Parking brake for proper operation.
Safety belts and seat latches for wear and function.
Safety warning lamps (brake, ABS, airbag and safety belt) for operation.
Washer spray and wiper operation. Clean or replace blades as necessary.

## Multi-Point Inspection

In order to keep your vehicle running right, it is important to have the systems on your vehicle checked regularly. This can help identify potential issues and prevent major problems. We recommend having the following multi-point inspection performed at every scheduled maintenance interval to help make sure your vehicle keeps running great.

# Scheduled Maintenance

Multi-Point Inspection	
Accessory drive belt(s)	Hazard warning system operation
Battery performance	Horn operation
Engine air filter	Radiator, cooler, heater and air conditioning hoses
Exhaust system	Suspension components for leaks or damage
Exterior lamps operation	Steering and linkage
Fluid levels <sup>1</sup> ; fill if necessary	Tires (including spare) for wear and proper pressure <sup>2</sup>
For oil and fluid leaks	Windshield for cracks, chips or pits
Half-shaft dust boots	Washer spray and wiper operation

<sup>1</sup> Brake, coolant recovery reservoir, automatic transmission and window washer

<sup>2</sup> If your vehicle is equipped with a temporary mobility kit, check the tire sealant expiration Use By date on the canister. Replace as needed.

Be sure to ask your dealership service advisor or technician about the multi-point vehicle inspection. It is a comprehensive way to perform a thorough inspection of your vehicle. Your checklist gives you immediate feedback on the overall condition of your vehicle.

## NORMAL SCHEDULED MAINTENANCE

### Intelligent Oil-Life Monitor™

Your vehicle is equipped with an Intelligent Oil-Life Monitor that determines when you should change the engine oil based on how your vehicle is used. By using several important factors in its calculations, the monitor helps reduce the cost of owning your vehicle and reduces environmental waste at the same time.

This means you do not have to remember to change the oil on a mileage-based schedule. Your vehicle lets you know when an oil change is due by displaying a message in the information display.

The following table provides examples of vehicle use and its impact on oil change intervals. It is a guideline only. Actual oil change intervals depend on several factors and generally decrease with severity of use.

# Scheduled Maintenance

<b>When to expect the message prompting you to change your oil</b>	
<b>Interval</b>	<b>Vehicle use and example</b>
7500-10000 miles (12000-16000 km)	<b>Normal</b>
	Normal commuting with highway driving No, or moderate, load or towing Flat to moderately hilly roads No extended idling
5000-7499 miles (8000-11999 km)	<b>Severe</b>
	Moderate to heavy load or towing Mountainous or off-road conditions Extended idling Extended hot or cold operation
3000-4999 miles (5000-7999 km)	<b>Extreme</b>
	Maximum load or towing Extreme hot or cold operation

## Maintenance Intervals

<b>At every oil change interval as indicated by the information display*</b>
Change engine oil and filter.**
Rotate the tires.
Perform a multi-point inspection (recommended).
Inspect the automatic transmission fluid level. Consult your dealer for requirements.
Inspect the brake pads, rotors, hoses and parking brake.
Inspect the engine cooling system strength and hoses.
Inspect the exhaust system and heat shields.
Inspect the half-shaft boots.
Inspect the steering linkage, ball joints, suspension, tie-rod ends, driveshaft and U-joints.



# Scheduled Maintenance

## At every oil change interval as indicated by the information display\*

Inspect the tires, tire wear and measure the tread depth.
Inspect the wheels and related components for abnormal noise, wear, looseness or drag.

\* Do not exceed one year or 10000 miles (16000 kilometers) between service intervals.

\*\* Reset the Intelligent Oil-Life Monitor after engine oil and filter changes. See **Engine Oil Check** (page 266).

## Other maintenance items<sup>1</sup>

Every 20000 miles (32000 km)	Replace cabin air filter.
Every 30000 miles (48000 km)	Replace engine air filter.
At 100000 miles (160000 km)	Change engine coolant. <sup>2</sup>
Every 100000 miles (160000 km)	Replace spark plugs.
	Inspect accessory drive belt(s). <sup>3</sup>
Every 150000 miles (240000 km)	Change automatic transmission fluid.
	Replace accessory drive belt(s). <sup>4</sup>

<sup>1</sup> Perform these maintenance items within 3000 miles (4800 kilometers) of the last engine oil and filter change. Do not exceed the designated distance for the interval.

<sup>2</sup> Initial replacement at six years or 100000 miles (160000 kilometers), then every three years or 50000 miles (80000 kilometers).

<sup>3</sup> After initial inspection, inspect every other oil change until replaced.

<sup>4</sup> If not replaced within the last 100000 miles (160000 kilometers).

# Scheduled Maintenance

## SPECIAL OPERATING CONDITIONS SCHEDULED MAINTENANCE

If you operate your vehicle **primarily** in any of the following conditions, you need to perform extra maintenance as indicated. If you operate your vehicle **occasionally** under any of these conditions, it is not necessary to perform the extra maintenance. For specific recommendations, see your dealership service advisor or technician.

Perform the services shown in the following tables when specified, or within 3000 miles (4800 kilometers) of a message indicating that an oil change is required appears in the information display.

- **Example 1:** The oil change required message comes on at 28751 miles (46270 kilometers). Perform the 30000-mile (48000-kilometer) automatic transmission fluid replacement.
- **Example 2:** The oil change required message has **not** come on, but the odometer reads 30000 miles (48000 kilometers) (for example, the Intelligent Oil-Life Monitor was reset at 25000 miles [40000 kilometers]). Perform the engine air filter replacement.

<b>Towing a trailer or using a car-top carrier</b>	
As required	Change engine oil and filter as indicated by the information display and perform services listed in the Normal Scheduled Maintenance chart.
Every 30000 miles (48000 km)	Change automatic transmission fluid.
Every 60000 miles (96000 km)	Replace spark plugs.

<b>Extensive idling or low-speed driving for long distances, as in heavy commercial use (such as delivery, taxi, patrol car or livery)</b>	
As required	Change engine oil and filter as indicated by the information display and perform services listed in the Normal Scheduled Maintenance chart.
Inspect frequently, service as required	Replace cabin air filter.
	Replace engine air filter.

## Scheduled Maintenance

<b>Extensive idling or low-speed driving for long distances, as in heavy commercial use (such as delivery, taxi, patrol car or livery)</b>	
Every 30000 miles (48000 km)	Change automatic transmission fluid.
Every 60000 miles (96000 km)	Replace spark plugs.

\* This is an optional feature.

<b>Operating in dusty or sandy conditions (such as unpaved or dusty roads)</b>	
Inspect frequently, service as required	Replace cabin air filter.
	Replace engine air filter.
Every 5000 miles (8000 km)	Inspect the wheels and related components for abnormal noise, wear, looseness or drag.
	Rotate tires, inspect tires for wear and measure tread depth.
Every 5000 miles (8000 km) or six months	Change engine oil and filter. *
	Perform multi-point inspection.
Every 30000 miles (48000 km)	Change automatic transmission fluid.

\* Reset your Intelligent Oil-Life Monitor after engine oil and filter changes. See **Engine Oil Check** (page 266).

# Scheduled Maintenance

## SCHEDULED MAINTENANCE RECORD

<input type="radio"/> Repair Order #:	<p>Dealer stamp</p>
<input type="radio"/> Distance:	
<input type="radio"/> Engine hours (optional):	
<input type="radio"/> Multi-point inspection (recommended): <input type="checkbox"/>	
<input type="radio"/> Signature:	

<input type="radio"/> Repair Order #:	<p>Dealer stamp</p>
<input type="radio"/> Distance:	
<input type="radio"/> Engine hours (optional):	
<input type="radio"/> Multi-point inspection (recommended): <input type="checkbox"/>	
<input type="radio"/> Signature:	

# Scheduled Maintenance

<input type="radio"/> Repair Order #:	<p>Dealer stamp</p>
<input type="radio"/> Distance:	
<input type="radio"/> Engine hours (optional):	
<input type="radio"/> Multi-point inspection (recommended): <input type="checkbox"/>	
<input type="radio"/> Signature:	

<input type="radio"/> Repair Order #:	<p>Dealer stamp</p>
<input type="radio"/> Distance:	
<input type="radio"/> Engine hours (optional):	
<input type="radio"/> Multi-point inspection (recommended): <input type="checkbox"/>	
<input type="radio"/> Signature:	

# Scheduled Maintenance

<input type="radio"/> Repair Order #:	Dealer stamp
<input type="radio"/> Distance:	
<input type="radio"/> Engine hours (optional):	
<input type="radio"/> Multi-point inspection (recommended): <input type="checkbox"/>	
<input type="radio"/> Signature:	

<input type="radio"/> Repair Order #:	Dealer stamp
<input type="radio"/> Distance:	
<input type="radio"/> Engine hours (optional):	
<input type="radio"/> Multi-point inspection (recommended): <input type="checkbox"/>	
<input type="radio"/> Signature:	

# Scheduled Maintenance

---

<input type="radio"/> Repair Order #:	<p>Dealer stamp</p>
<input type="radio"/> Distance:	
<input type="radio"/> Engine hours (optional):	
<input type="radio"/> Multi-point inspection (recommended): <input type="checkbox"/>	
<input type="radio"/> Signature:	

<input type="radio"/> Repair Order #:	<p>Dealer stamp</p>
<input type="radio"/> Distance:	
<input type="radio"/> Engine hours (optional):	
<input type="radio"/> Multi-point inspection (recommended): <input type="checkbox"/>	
<input type="radio"/> Signature:	

# Scheduled Maintenance

<input type="radio"/> Repair Order #:	Dealer stamp
<input type="radio"/> Distance:	
<input type="radio"/> Engine hours (optional):	
<input type="radio"/> Multi-point inspection (recommended): <input type="checkbox"/>	
<input type="radio"/> Signature:	

<input type="radio"/> Repair Order #:	Dealer stamp
<input type="radio"/> Distance:	
<input type="radio"/> Engine hours (optional):	
<input type="radio"/> Multi-point inspection (recommended): <input type="checkbox"/>	
<input type="radio"/> Signature:	



# Scheduled Maintenance

<input type="radio"/> Repair Order #:	<p>Dealer stamp</p>
<input type="radio"/> Distance:	
<input type="radio"/> Engine hours (optional):	
<input type="radio"/> Multi-point inspection (recommended): <input type="checkbox"/>	
<input type="radio"/> Signature:	

<input type="radio"/> Repair Order #:	<p>Dealer stamp</p>
<input type="radio"/> Distance:	
<input type="radio"/> Engine hours (optional):	
<input type="radio"/> Multi-point inspection (recommended): <input type="checkbox"/>	
<input type="radio"/> Signature:	

# Scheduled Maintenance

<input type="radio"/> Repair Order #:	<p>Dealer stamp</p>
<input type="radio"/> Distance:	
<input type="radio"/> Engine hours (optional):	
<input type="radio"/> Multi-point inspection (recommended): <input type="checkbox"/>	
<input type="radio"/> Signature:	

<input type="radio"/> Repair Order #:	<p>Dealer stamp</p>
<input type="radio"/> Distance:	
<input type="radio"/> Engine hours (optional):	
<input type="radio"/> Multi-point inspection (recommended): <input type="checkbox"/>	
<input type="radio"/> Signature:	

# Scheduled Maintenance

<input type="radio"/> Repair Order #:	<p>Dealer stamp</p>
<input type="radio"/> Distance:	
<input type="radio"/> Engine hours (optional):	
<input type="radio"/> Multi-point inspection (recommended): <input type="checkbox"/>	
<input type="radio"/> Signature:	

<input type="radio"/> Repair Order #:	<p>Dealer stamp</p>
<input type="radio"/> Distance:	
<input type="radio"/> Engine hours (optional):	
<input type="radio"/> Multi-point inspection (recommended): <input type="checkbox"/>	
<input type="radio"/> Signature:	

# Scheduled Maintenance

<input type="radio"/> Repair Order #:	<p>Dealer stamp</p>
<input type="radio"/> Distance:	
<input type="radio"/> Engine hours (optional):	
<input type="radio"/> Multi-point inspection (recommended): <input type="checkbox"/>	
<input type="radio"/> Signature:	

<input type="radio"/> Repair Order #:	<p>Dealer stamp</p>
<input type="radio"/> Distance:	
<input type="radio"/> Engine hours (optional):	
<input type="radio"/> Multi-point inspection (recommended): <input type="checkbox"/>	
<input type="radio"/> Signature:	

# Scheduled Maintenance

<input type="radio"/> Repair Order #:	<p>Dealer stamp</p>
<input type="radio"/> Distance:	
<input type="radio"/> Engine hours (optional):	
<input type="radio"/> Multi-point inspection (recommended): <input type="checkbox"/>	
<input type="radio"/> Signature:	

<input type="radio"/> Repair Order #:	<p>Dealer stamp</p>
<input type="radio"/> Distance:	
<input type="radio"/> Engine hours (optional):	
<input type="radio"/> Multi-point inspection (recommended): <input type="checkbox"/>	
<input type="radio"/> Signature:	

## Appendices

### ELECTROMAGNETIC COMPATIBILITY



**WARNING:** Do not place objects or mount equipment on or near the airbag cover, on the side of the seatbacks (of the front seats), or in front seat areas that may come into contact with a deploying airbag. Failure to follow these instructions may increase the risk of personal injury in the event of a crash.



**WARNING:** Do not fasten antenna cables to original vehicle wiring, fuel pipes and brake pipes.



**WARNING:** Keep antenna and power cables at least 4 in (10 cm) from any electronic modules and airbags.

**Note:** We test and certify your vehicle to meet electromagnetic compatibility legislation (UNECE Regulation 10 or other applicable local requirements). It is your responsibility to make sure that any equipment an authorized dealer installs on your vehicle complies with applicable local legislation and other requirements.

**Note:** Any radio frequency transmitter equipment in your vehicle (such as cellular telephones and amateur radio transmitters) must keep to the parameters in the following table. We do not provide special provisions or conditions for installations or use.

### Car

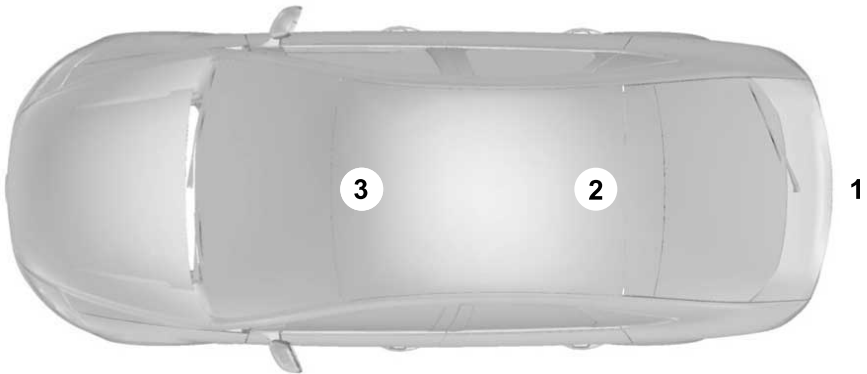

E239120

# Appendices

---

## Van

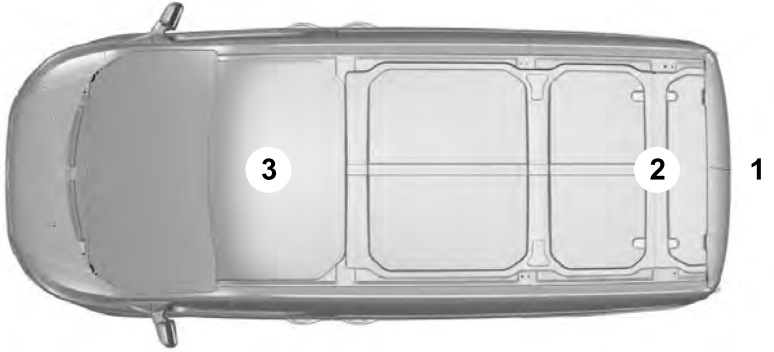

E239122

## Truck

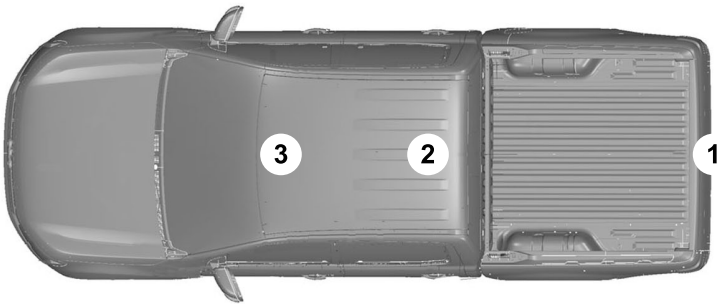

E239121

# Appendices

Frequency Band MHz	Maximum output power Watt (Peak RMS)	Antenna Positions
1-30	50	1
50-54	50	2, 3
68-88	50	2, 3
142-176	50	2, 3
380-512	50	2, 3
806-870	10	2, 3

**Note:** After the installation of radio frequency transmitters, check for disturbances from and to all electrical equipment in your vehicle, both in the standby and transmit modes.

Check all electrical equipment:

- With the ignition ON.
- With the engine running.
- During a road test at various speeds.

Check that electromagnetic fields generated inside your vehicle cabin by the transmitter installed do not exceed applicable human exposure requirements.

## END USER LICENSE AGREEMENT

### VEHICLE SOFTWARE END USER LICENSE AGREEMENT (EULA)

- You ("You" or "Your" as applicable) have acquired a vehicle having several devices, including SYNC ® and various control modules, ("DEVICES") that include software licensed or owned by Ford Motor Company and its affiliates ("FORD MOTOR COMPANY"). Those software products of FORD MOTOR COMPANY origin, as well as associated media, printed materials, and "online" or electronic documentation ("SOFTWARE") are protected by international intellectual property laws and treaties. The SOFTWARE is licensed, not sold. All rights reserved.
- The SOFTWARE may interface with and/or communicate with, or may be later upgraded to interface with and/or communicate with additional software and/or systems provided by FORD MOTOR COMPANY.



# Appendices

---

**IF YOU DO NOT AGREE TO THIS END USER LICENSE AGREEMENT ("EULA") DO NOT USE THE DEVICES OR COPY THE SOFTWARE. ANY USE OF THE SOFTWARE, INCLUDING BUT NOT LIMITED TO USE ON THE DEVICES, WILL CONSTITUTE YOUR AGREEMENT TO THIS EULA (OR RATIFICATION OF ANY PREVIOUS CONSENT).**

**GRANT OF SOFTWARE LICENSE:** This EULA grants you the following license:

- You may use the SOFTWARE as installed on the DEVICES and as otherwise interfacing with systems and/or services provide by or through FORD MOTOR COMPANY or its third party software and service providers.

## **Description of Other Rights and Limitations**

- **Speech Recognition:** If the SOFTWARE includes speech recognition component(s), you should understand that speech recognition is an inherently statistical process and that recognition errors are inherent in the process. Neither FORD MOTOR

COMPANY nor its suppliers shall be liable for any damages arising out of errors in the speech recognition process. It is your responsibility to monitor any speech recognition functions included in the system.

- **Limitations on Reverse Engineering, Decompilation and Disassembly:**

You may not reverse engineer, decompile, translate, disassemble or attempt to discover any source code or underlying ideas or algorithms of the SOFTWARE nor permit others to reverse engineer, decompile or disassemble the SOFTWARE, except and only to the extent that such activity is expressly permitted by applicable law notwithstanding this limitation or to the extent as may be permitted by the licensing terms governing use of any open source components included with the SOFTWARE.

- **Limitations on Distributing, Copying, Modifying and Creating Derivative Works:**

You may not distribute, copy, make modifications to or create derivative works based on the SOFTWARE, except and only to the extent that such activity is expressly permitted by applicable law notwithstanding this limitation or to the extent as may be permitted by the licensing terms governing use of any open source components included with the SOFTWARE.

- **Single EULA:** The end user documentation for the DEVICES and related systems and services may contain multiple EULAs, such as multiple translations and/or multiple media versions (e.g., in the user documentation and in the software). Even if you receive multiple EULAs, you are licensed to use only one (1) copy of the SOFTWARE.

## Appendices

---

- **SOFTWARE Transfer:** You may permanently transfer your rights under this EULA only as part of a sale or transfer of the DEVICES, provided you retain no copies, you transfer all of the SOFTWARE (including all component parts, the media and printed materials, any upgrades, and, if applicable, the Certificate(s) of Authenticity), and the recipient agrees to the terms of this EULA. If the SOFTWARE is an upgrade, any transfer must include all prior versions of the SOFTWARE.
- **Termination:** Without prejudice to any other rights, FORD MOTOR COMPANY may terminate this EULA if you fail to comply with the terms and conditions of this EULA.
- **Internet-Based Services Components:** The SOFTWARE may contain components that enable and facilitate the use of certain Internet-based services. You acknowledge and agree that FORD MOTOR COMPANY, third party software and service suppliers, its affiliates and/or its designated agent may automatically check the version of the SOFTWARE and/or its components that you are utilizing and may provide upgrades or supplements to the SOFTWARE that may be automatically downloaded to your DEVICES.
- **Additional Software/Services:** The SOFTWARE may permit FORD MOTOR COMPANY, third party software and service suppliers, its affiliates and/or its designated agent to provide or make available to you SOFTWARE updates, supplements, add-on components, or Internet-based services components of the SOFTWARE after the date you obtain your initial copy of the SOFTWARE ("Supplemental Components".) SOFTWARE updates may cause you to incur additional charges from your wireless service provider. If FORD MOTOR COMPANY or third party software and services suppliers provide or make available to you Supplemental Components and no other EULA terms are provided along with the Supplemental Components, then the terms of this EULA shall apply. FORD MOTOR COMPANY, its affiliates and/or its designated agent reserve the right to discontinue without liability any Internet-based services provided to you or made available to you through the use of the SOFTWARE.
- **Links to Third Party Sites:** The SOFTWARE may provide you with the ability to link to third party sites. The third party sites are not under the control of FORD MOTOR COMPANY, its affiliates and/or its designated agent. Neither FORD MOTOR COMPANY nor its affiliates nor its designated agent are responsible for (i) the contents of any third party sites, any links contained in third party sites, or any changes or updates to third party sites, or (ii) webcasting or any other form of transmission received from any third party sites. If the SOFTWARE provides links to third party sites, those links are provided to you only as a convenience, and the inclusion of any link does not imply an endorsement of the third party site by FORD MOTOR COMPANY, its affiliates and/or its designated agent.
- **Obligation to Drive Responsibly:** You recognize your obligation to drive responsibly and keep attention on the road. You will read and abide with the DEVICES operating instructions particularly as they pertain to safety and you agree to assume any risk associated with the use of the DEVICES.

# Appendices

---

## **UPGRADES AND RECOVERY MEDIA:**

If the SOFTWARE is provided by FORD MOTOR COMPANY separate from the DEVICES on media such as a ROM chip, CD ROM disk(s) or via web download or other means, and is labeled "For Upgrade Purposes Only" or "For Recovery Purposes Only" you may install one (1) copy of such SOFTWARE onto the DEVICES as a replacement copy for the existing SOFTWARE, and use it in accordance with this EULA, including any additional EULA terms accompanying the upgrade SOFTWARE.

## **INTELLECTUAL PROPERTY RIGHTS:**

All title and intellectual property rights in and to the SOFTWARE (including but not limited to any images, photographs, animations, video, audio, music, text and "applets" incorporated into the SOFTWARE), the accompanying printed materials, and any copies of the SOFTWARE, are owned by FORD MOTOR COMPANY, or its affiliates or suppliers. The SOFTWARE is licensed, not sold. You may not copy the printed materials accompanying the SOFTWARE. All title and intellectual property rights in and to the content which may be accessed through use of the SOFTWARE is the property of the respective content owner and may be protected by applicable copyright or other intellectual property laws and treaties. This EULA grants you no rights to use such content outside its intended use. All rights not specifically granted under this EULA are reserved by FORD MOTOR COMPANY, its affiliates, and third party software and service providers and suppliers. Use of any on-line services which may be accessed through the SOFTWARE may be governed by the respective terms of use relating to such services. If this SOFTWARE contains documentation that is provided only in electronic form, you may print one copy of such electronic documentation.

**EXPORT RESTRICTIONS:** You acknowledge that the SOFTWARE is subject to U.S. and European Union export jurisdiction. You agree to comply with all applicable international and national laws that apply to the SOFTWARE, including the U.S. Export Administration Regulations, as well as end-user, end-use and destination restrictions issued by U.S. and other governments.

**TRADEMARKS:** This EULA does not grant you any rights in connection with any trademarks or service marks of FORD MOTOR COMPANY, its affiliates, and third party software and service providers.

**PRODUCT SUPPORT:** Please refer to FORD MOTOR COMPANY instructions provided in the documentation for the DEVICES product support, such as the vehicle owner guide.

Should you have any questions concerning this EULA, or if you desire to contact FORD MOTOR COMPANY for any other reason, please refer to the address provided in the documentation for the DEVICES.

## **No Liability for Certain Damages:**

EXCEPT AS PROHIBITED BY LAW, FORD MOTOR COMPANY, ANY THIRD PARTY SOFTWARE OR SERVICES SUPPLIERS, AND THEIR AFFILIATES SHALL HAVE NO LIABILITY FOR ANY INDIRECT, SPECIAL, CONSEQUENTIAL OR INCIDENTAL DAMAGES ARISING FROM OR IN CONNECTION WITH THE USE OR PERFORMANCE OF THE SOFTWARE. THIS LIMITATION SHALL APPLY EVEN IF ANY REMEDY FAILS OF ITS ESSENTIAL PURPOSE. THERE ARE NO WARRANTIES OTHER THAN THOSE THAT MAY BE EXPRESSLY PROVIDED FOR YOUR NEW VEHICLE.

# Appendices

---

## **SYNC® Automotive Important Safety Information Read and follow instructions:**

- Before using your SYNC® system, read and follow all instructions and safety information provided in this end user manual ("Owner Guide".) Not following precautions found in the Owner Guide can lead to an accident or other serious injuries.

### General Operation

- **Voice Command Control:** Certain functions within the SYNC® system may be accomplished using voice commands. Using voice commands while driving helps you to operate the system without removing your hands from the wheel or eyes from the road.
- **Prolonged Views of Screen:** Do not access any function requiring a prolonged view of the screen while you are driving. Pull over in a safe and legal manner before attempting to access a function of the system requiring prolonged attention.
- **Volume Setting:** Do not raise the volume excessively. Keep the volume at a level where you can still hear outside traffic and emergency signals while driving. Driving while unable to hear these sounds could cause an accident.
- **Navigation Features:** Any navigation features included in the system are intended to provide turn by turn instructions to get you to a desired destination. Please make certain all persons using this system carefully read and follow instructions and safety information fully.
- **Distraction Hazard:** Any navigation features may require manual (non-verbal) setup. Attempting to perform such set-up or insert data while driving can distract your attention and could cause an accident or other serious injury. Stop the vehicle in a safe and legal manner before attempting these operations.
- **Let Your Judgment Prevail:** Any navigation features are provided only as an aid. Make your driving decisions based on your observations of local conditions and existing traffic regulations. Any such feature is not a substitute for your personal judgment. Any route suggestions made by this system should never replace any local traffic regulations or your personal judgment or knowledge of safe driving practices.
- **Route Safety:** Do not follow the route suggestions if doing so would result in an unsafe or illegal maneuver, if you would be placed in an unsafe situation, or if you would be directed into an area that you consider unsafe. The driver is ultimately responsible for the safe operation of the vehicle and therefore, must evaluate whether it is safe to follow the suggested directions.
- **Potential Map Inaccuracy:** Maps used by this system may be inaccurate because of changes in roads, traffic controls or driving conditions. Always use good judgment and common sense when following the suggested routes.
- **Emergency Services:** Do not rely on any navigation features included in the system to route you to emergency services. Ask local authorities or an emergency services operator for these locations. Not all emergency services such as police, fire stations, hospitals and clinics are likely to be contained in the map database for such navigation features.

# Appendices

---

## Your Responsibilities and Assumptions of Risk

- You agree to each of the following: (a) Any use of the SOFTWARE while driving an automobile or other vehicle in violation of applicable law or otherwise driving in an unsafe manner presents a significant risk of distracted driving and should not be attempted under any circumstances; (b) Use of the SOFTWARE at excessive volume poses a significant risk of hearing damage and should not be attempted under any circumstances; (c) The SOFTWARE may not be compatible with new or different versions of an operating system, third party software, or third party services, and the SOFTWARE may potentially cause a critical failure of an operating system, third party software, or third party service. (d) Any third party service accessed by or third party software used with the SOFTWARE (i) may charge an additional fee for access, (ii) may not work correctly, on an uninterrupted basis, or error free, (iii) may change streaming formats or discontinue operation, (iv) may contain adult, profane or offensive content; and (v) may contain inaccurate, false or misleading traffic, weather, financial or safety information or other content; and (e) Use of the SOFTWARE may cause you to incur additional charges from your wireless service provider (WSP) and any data or minute calculators that may be included in the software program are for reference only, are not warranted in any way and should not be relied upon in anyway.
- When using the SOFTWARE, you agree to be responsible for and assume the entire risk to the items set forth in Section (a) – (e) above.

## Disclaimer of Warranty

YOU EXPRESSLY ACKNOWLEDGE AND AGREE THAT USE OF THE DEVICES AND SOFTWARE IS AT YOUR SOLE RISK AND THAT THE ENTIRE RISK AS TO SATISFACTORY QUALITY, PERFORMANCE, COMPATIBILITY, ACCURACY AND EFFORT IS WITH YOU. TO THE MAXIMUM EXTENT PERMITTED BY APPLICABLE LAW, THE SOFTWARE AND ANY THIRD PARTY SOFTWARE OR THIRD-PARTY SERVICES ARE PROVIDED "AS IS" AND "AS AVAILABLE", WITH ALL FAULTS AND WITHOUT WARRANTY OF ANY KIND, AND FORD MOTOR COMPANY HEREBY DISCLAIMS ALL WARRANTIES AND CONDITIONS WITH RESPECT TO THE SOFTWARE, THIRD PARTY SOFTWARE, AND THIRD-PARTY SERVICES, EITHER EXPRESS, IMPLIED OR STATUTORY, INCLUDING, BUT NOT LIMITED TO, THE IMPLIED WARRANTIES AND/OR CONDITIONS OF MERCHANTABILITY, OF SATISFACTORY QUALITY, OF FITNESS FOR AN PARTICULAR PURPOSE, OF ACCURACY, OF QUIET ENJOYMENT, AND NON-INFRINGEMENT OF THIRD-PARTY RIGHTS. FORD MOTOR COMPANY DOES NOT WARRANT (a) AGAINST INTERFERENCE WITH YOUR ENJOYMENT OF THE SOFTWARE, THIRD PARTY SOFTWARE, OR THIRD-PARTY SERVICES, (b) THAT THE SOFTWARE, THIRD PARTY SOFTWARE, OR THIRD-PARTY SERVICES WILL MEET YOUR REQUIREMENTS, (c) THAT THE OPERATION OF THE SOFTWARE, THIRD PARTY SOFTWARE, OR THIRD-PARTY SERVICES WILL BE UNINTERRUPTED OR ERROR-FREE, (d) OR THAT DEFECTS IN THE SOFTWARE, THIRD PARTY SOFTWARE, OR THIRD-PARTY SERVICES WILL BE CORRECTED. NO ORAL OR WRITTEN INFORMATION OR ADVICE GIVEN BY FORD MOTOR COMPANY OR ITS AUTHORIZED REPRESENTATIVE SHALL

# Appendices

---

CREATE A WARRANTY. SHOULD THE SOFTWARE, THIRD PARTY SOFTWARE, OR THIRD-PARTY SERVICES PROVE DEFECTIVE, YOU ASSUME THE ENTIRE COST OF ALL NECESSARY SERVICING, REPAIR OR CORRECTION. SOME JURISDICTIONS DO NOT ALLOW THE DISCLAIMER OF IMPLIED WARRANTIES OR LIMITATIONS ON APPLICABLE STATUTORY RIGHTS OF A CONSUMER, SO THE ABOVE DISCLAIMER MAY NOT FULLY APPLY TO YOU. THE SOLE WARRANTY PROVIDED BY FORD MOTOR COMPANY SHALL BE FOUND IN THE WARRANTY INFORMATION INCLUDING WITH YOUR OWNER GUIDE. TO THE EXTENT THAT THERE IS ANY CONFLICT BETWEEN THE TERMS OF THIS SECTION AND THE WARRANTY BOOKLET, THE WARRANTY BOOKLET SHALL CONTROL.

## Applicable Law, Venue, Jurisdiction

- The laws of the State of Michigan govern this EULA and Your use of the SOFTWARE. Your use of the SOFTWARE may also be subject to other local, state, national, or international laws. Any litigation arising out of or related to this EULA shall be brought and maintained exclusively in a court of the State of Michigan located in Wayne County or in the United States District Court for the Eastern District of Michigan. You hereby consent to submit to the personal jurisdiction of a court in the State of Michigan located in Wayne County and the United States District Court for the Eastern District of Michigan for any dispute arising out of or relating to this EULA.

## Binding Arbitration and Class Action Waiver

**(a) Application.** This Section applies to any dispute EXCEPT IT DOES NOT INCLUDE A DISPUTE RELATING TO COPYRIGHT INFRINGEMENT, OR TO THE ENFORCEMENT OR VALIDITY OF YOUR, FORD MOTOR COMPANY, OR ANY OF FORD MOTOR COMPANY'S LICENSORS' INTELLECTUAL PROPERTY RIGHTS.

Dispute means any dispute, action, or other controversy between You and FORD MOTOR COMPANY, other than the exceptions listed above, concerning the SOFTWARE (including its price) or this EULA, whether in contract, warranty, tort, statute, regulation, ordinance, or any other legal or equitable basis.

**(b) Notice of Dispute.** In the event of a Dispute, You or FORD MOTOR COMPANY must give the other a "Notice of Dispute", which is a written statement of the name, address, and contact information of the party giving it, the facts giving rise to the dispute, and the relief requested. You and FORD MOTOR COMPANY will attempt to resolve any dispute through informal negotiation within 60 days from the date the Notice of Dispute is sent. After 60 days, You or FORD MOTOR COMPANY may commence arbitration.

**(c) Small claims court.** You may also litigate any dispute in small claims court in your county of residence or FORD MOTOR COMPANY'S principal place of business, if the dispute meets all requirements to be heard in the small claims court. You may litigate in small claims court whether or not You negotiated informally first.

**(d) Binding arbitration.** If You and FORD MOTOR COMPANY, do not resolve any dispute by informal negotiation or in small claims court, any other effort to resolve the dispute will be conducted exclusively by binding arbitration. You are giving up

## Appendices

---

the right to litigate (or participate in as a party or class member) all disputes in court before a judge or jury. Instead, all disputes will be resolved before a neutral arbitrator, whose decision will be final except for a limited right of appeal under the Federal Arbitration Act. Any court with jurisdiction over the parties may enforce the arbitrator's award.

**(e) Class action waiver.** Any proceedings to resolve or litigate any dispute in any forum will be conducted solely on an individual basis. Neither you nor FORD MOTOR COMPANY, will seek to have any dispute heard as a class action, as a private attorney general action, or in any other proceeding in which any party acts or proposes to act in a representative capacity. No arbitration or proceeding will be combined with another without the prior written consent of all parties to all affected arbitrations or proceedings.

**(f) Arbitration procedure.** Any arbitration will be conducted by the American Arbitration Association (the "AAA"), under its Commercial Arbitration Rules. If You are an individual and use the SOFTWARE for personal or vehicle use, or if the value of the dispute is \$75,000 or less whether or not You are an individual or how You use the SOFTWARE, the AAA Supplementary Procedures for Consumer-Related Disputes will also apply. To commence arbitration, submit a Commercial Arbitration Rules Demand for Arbitration form to the AAA. You may request a telephonic or in-person hearing by following the AAA rules. In a dispute involving \$10,000 or less, any hearing will be telephonic unless the arbitrator finds good cause to hold an in-person hearing instead. For more information, see [adr.org](http://adr.org) or call 1-800-778-7879. You agree to commence arbitration only in your county of residence or FORD MOTOR COMPANY'S principal place of business. The arbitrator

may award the same damages to You individually as a court could. The arbitrator may award declaratory or injunctive relief only to You individually, and only to the extent required to satisfy Your individual claim.

### **(g) Arbitration fees and incentives.**

- I. Disputes involving \$75,000 or less. FORD MOTOR COMPANY will promptly reimburse your filing fees and pay the AAA's and arbitrator's fees and expenses. If you reject FORD MOTOR COMPANY'S last written settlement offer made before the arbitrator was appointed ("last written offer"), your dispute goes all the way to an arbitrator's decision (called an "award"), and the arbitrator awards you more than the last written offer, FORD MOTOR COMPANY will give you three incentives: (1) pay the greater of the award or \$1,000; (2) pay twice your reasonable attorney's fees, if any; and (3) reimburse any expenses (including expert witness fees and costs) that your attorney reasonably accrues for investigating, preparing, and pursuing your claim in arbitration. The arbitrator will determine the amounts.
- ii. Disputes involving more than \$75,000. The AAA rules will govern payment of filing fees and the AAA's and arbitrator's fees and expenses.
- iii. Disputes involving any amount. In any arbitration you commence, FORD MOTOR COMPANY will seek its AAA or arbitrator's fees and expenses, or Your filing fees it reimbursed, only if the arbitrator finds the arbitration frivolous or brought for an improper purpose. In any arbitration FORD MOTOR COMPANY commences, it will pay all

# Appendices

---

filing, AAA, and arbitrator's fees and expenses. It will not seek its attorney's fees or expenses from you in any arbitration. Fees and expenses are not counted in determining how much a dispute involves.

**(h) Claims or disputes must be filed within one year.** To the extent permitted by law, any claim or dispute under this EULA to which this Section applies must be filed within one year in small claims court (Section c) or in arbitration (Section d). The one-year period begins when the claim or dispute first could be filed. If such a claim or dispute is not filed within one year, it is permanently barred.

**(I) Severability.** If the class action waiver (Section e) is found to be illegal or unenforceable as to all or some parts of a dispute, then that portion of Section e will not apply to those parts. Instead, those parts will be severed and proceed in a court of law, with the remaining parts proceeding in arbitration. If any other provision of that portion Section e is found to be illegal or unenforceable, that provision will be severed with the remainder of Section e remaining in full force and effect.

## **Telenav Software End User License Agreement**

Please read these terms and conditions carefully before you use the TeleNav Software. Your use of the TeleNav Software indicates that you accept these terms and conditions. If you do not accept these terms and conditions, do not break the seal of the package, launch, or otherwise use the TeleNav Software. TeleNav may revise this Agreement and the privacy policy at any time, with or without notice to you. You agree to visit <http://www.telenav.com> from time to time to review the then current version of this Agreement and of the privacy policy.

## **1. Safe and Lawful Use**

You acknowledge that devoting attention to the TeleNav Software may pose a risk of injury or death to you and others in situations that otherwise require your undivided attention, and you therefore agree to comply with the following when using the TeleNav Software:

- (a) observe all traffic laws and otherwise drive safely;
- (b) use your own personal judgment while driving. If you feel that a route suggested by the TeleNav Software instructs you to perform an unsafe or illegal maneuver, places you in an unsafe situation, or directs you into an area that you consider to be unsafe, do not follow such instructions;
- (c) do not input destinations, or otherwise manipulate the TeleNav Software, unless your vehicle is stationary and parked;
- (d) do not use the TeleNav Software for any illegal, unauthorized, unintended, unsafe, hazardous, or unlawful purposes, or in any manner inconsistent with this Agreement;
- (e) arrange all GPS and wireless devices and cables necessary for use of the TeleNav Software in a secure manner in your vehicle so that they will not interfere with your driving and will not prevent the operation of any safety device (such as an airbag).

You agree to indemnify and hold TeleNav harmless against all claims resulting from any dangerous or otherwise inappropriate use of the TeleNav Software in any moving vehicle, including as a result of your failure to comply with the directions above.



# Appendices

---

## 2. Account Information

You agree: (a) when registering the TeleNav Software, to provide TeleNav with true, accurate, current, and complete information about yourself, and (b) to inform TeleNav promptly of any changes to such information, and to keep it true, accurate, current and complete.

## 3. Software License

- Subject to your compliance with the terms of this Agreement, TeleNav hereby grants to you a personal, non-exclusive, non-transferable license (except as expressly permitted below in connection with your permanent transfer of the TeleNav Software license), without the right to sublicense, to use the TeleNav Software (in object code form only) in order to access and use the TeleNav Software. This license shall terminate upon any termination or expiration of this Agreement. You agree that you will use the TeleNav Software only for your personal business or leisure purposes, and not to provide commercial navigation services to other parties.

### 3.1 License Limitations

- **(a)** reverse engineer, decompile, disassemble, translate, modify, alter or otherwise change the TeleNav Software or any part thereof; **(b)** attempt to derive the source code, audio library or structure of the TeleNav Software without the prior express written consent of TeleNav; **(c)** remove from the TeleNav Software, or alter, any of TeleNav's or its suppliers' trademarks, trade names, logos, patent or copyright notices, or other notices or markings; **(d)**

distribute, sublicense or otherwise transfer the TeleNav Software to others, except as part of your permanent transfer of the TeleNav Software; or **(e)** use the TeleNav Software in any manner that

- i. infringes the intellectual property or proprietary rights, rights of publicity or privacy or other rights of any party,
- ii. violates any law, statute, ordinance or regulation, including but not limited to laws and regulations related to spamming, privacy, consumer and child protection, obscenity or defamation, or
- iii. is harmful, threatening, abusive, harassing, tortuous, defamatory, vulgar, obscene, libelous, or otherwise objectionable; and (f) lease, rent out, or otherwise permit unauthorized access by third parties to the TeleNav Software without advanced written permission of TeleNav.

## 4. Disclaimers

- To the fullest extent permissible pursuant to applicable law, in no event will TeleNav, its licensors and suppliers, or agents or employees of any of the foregoing, be liable for any decision made or action taken by you or anyone else in reliance on the information provided by the TeleNav Software. TeleNav also does not warrant the accuracy of the map or other data used for the TeleNav Software. Such data may not always reflect reality due to, among other things, road closures, construction, weather, new roads and other changing conditions. You are responsible for the entire risk arising out of your use of the TeleNav Software. For example but without limitation, you agree not to rely on the TeleNav Software for critical navigation in areas where the well-being or survival of you or others

# Appendices

---

is dependent on the accuracy of navigation, as the maps or functionality of the TeleNav Software are not intended to support such high risk applications, especially in more remote geographical areas.

- TELENV EXPRESSLY DISCLAIMS AND EXCLUDES ALL WARRANTIES IN CONNECTION WITH THE TELENV SOFTWARE, WHETHER STATUTORY, EXPRESS OR IMPLIED, INCLUDING ALL WARRANTIES WHICH MAY ARISE FROM COURSE OF DEALING, CUSTOM OR TRADE AND INCLUDING, BUT NOT LIMITED TO, THE IMPLIED WARRANTIES OF MERCHANTABILITY, FITNESS FOR A PARTICULAR PURPOSE AND NON-INFRINGEMENT OF THIRD PARTY RIGHTS WITH RESPECT TO THE TELENV SOFTWARE.
- Certain jurisdictions do not permit the disclaimer of certain warranties, so this limitation may not apply to you.

## **5. Limitation of Liability**

- TO THE EXTENT PERMITTED UNDER APPLICABLE LAW, UNDER NO CIRCUMSTANCES SHALL TELENV OR ITS LICENSORS AND SUPPLIERS BE LIABLE TO YOU OR TO ANY THIRD PARTY FOR ANY INDIRECT, INCIDENTAL, CONSEQUENTIAL, SPECIAL OR EXEMPLARY DAMAGES (INCLUDING IN EACH CASE, BUT NOT LIMITED TO, DAMAGES FOR THE INABILITY TO USE THE EQUIPMENT OR ACCESS DATA, LOSS OF DATA, LOSS OF BUSINESS, LOSS OF PROFITS, BUSINESS INTERRUPTION OR THE LIKE) ARISING OUT OF THE USE OF OR INABILITY TO USE THE TELENV SOFTWARE, EVEN IF TELENV HAS BEEN ADVISED OF THE POSSIBILITY OF SUCH DAMAGES. NOTWITHSTANDING ANY DAMAGES THAT YOU MIGHT INCUR FOR ANY

REASON WHATSOEVER (INCLUDING, WITHOUT LIMITATION, ALL DAMAGES REFERENCED HEREIN AND ALL DIRECT OR GENERAL DAMAGES IN CONTRACT, TORT (INCLUDING NEGLIGENCE) OR OTHERWISE), THE ENTIRE LIABILITY OF TELENV AND OF ALL OF TELENV'S SUPPLIERS SHALL BE LIMITED TO THE AMOUNT ACTUALLY PAID BY YOU FOR THE TELENV SOFTWARE. SOME STATES AND/OR JURISDICTIONS DO NOT ALLOW THE EXCLUSION OR LIMITATION OF INCIDENTAL OR CONSEQUENTIAL DAMAGES, SO THE ABOVE LIMITATIONS OR EXCLUSIONS MAY NOT APPLY TO YOU.

## **6. Arbitration and Governing Law**

- You agree that any dispute, claim or controversy arising out of or relating to this Agreement or the TeleNav Software shall be settled by independent arbitration involving a neutral arbitrator and administered by the American Arbitration Association in the County of Santa Clara, California. The arbitrator shall apply the Commercial Arbitration Rules of the American Arbitration Association, and the judgment upon the award rendered by the arbitrator may be entered by any court having jurisdiction. Note that there is no judge or jury in an arbitration proceeding and the decision of the arbitrator shall be binding upon both parties. You expressly agree to waive your right to a jury trial. This Agreement and performance hereunder will be governed by and construed in accordance with the laws of the State of California, without giving effect to its conflict of law provisions. To the extent judicial action is necessary in connection with the binding arbitration, both TeleNav and you agree to submit

# Appendices

---

to the exclusive jurisdiction of the courts of the County of Santa Clara, California. The United Nations Convention on Contracts for the International Sale of Goods shall not apply.

## **7. Assignment**

- You may not resell, assign, or transfer this Agreement or any of your rights or obligations, except in totality, in connection with your permanent transfer of the TeleNav Software, and expressly conditioned upon the new user of the TeleNav Software agreeing to be bound by the terms and conditions of this Agreement. Any such sale, assignment or transfer that is not expressly permitted under this paragraph will result in immediate termination of this Agreement, without liability to TeleNav, in which case you and all other parties shall immediately cease all use of the TeleNav Software. Notwithstanding the foregoing, TeleNav may assign this Agreement to any other party at any time without notice, provided the assignee remains bound by this Agreement.

## **8. Miscellaneous**

### **8.1**

This Agreement constitutes the entire agreement between TeleNav and you with respect to the subject matter hereof.

### **8.2**

Except for the limited licenses expressly granted in this Agreement, TeleNav retains all right, title and interest in and to the TeleNav Software, including without limitation all related intellectual property rights. No licenses or other rights which are not expressly granted in this Agreement are intended to, or shall be, granted or

conferred by implication, statute, inducement, estoppel or otherwise, and TeleNav and its suppliers and licensors hereby reserve all of their respective rights other than the licenses explicitly granted in this Agreement.

### **8.3**

By using the TeleNav Software, you consent to receive from TeleNav all communications, including notices, agreements, legally required disclosures or other information in connection with the TeleNav Software (collectively, "Notices") electronically. TeleNav may provide such Notices by posting them on TeleNav's Website or by downloading such Notices to your wireless device. If you desire to withdraw your consent to receive Notices electronically, you must discontinue your use of the TeleNav Software.

### **8.4**

TeleNav's or your failure to require performance of any provision shall not affect that party's right to require performance at any time thereafter, nor shall a waiver of any breach or default of this Agreement constitute a waiver of any subsequent breach or default or a waiver of the provision itself.

### **8.5**

If any provision herein is held unenforceable, then such provision will be modified to reflect the intention of the parties, and the remaining provisions of this Agreement will remain in full force and effect.

# Appendices

## 8.6

The headings in this Agreement are for convenience of reference only, will not be deemed to be a part of this Agreement, and will not be referred to in connection with the construction or interpretation of this Agreement. As used in this Agreement, the words "include" and "including" and variations thereof, will not be deemed to be terms of limitation, but rather will be deemed to be followed by the words "without limitation".

## 9. Other Vendors Terms and Conditions

- The Telenav Software utilizes map and other data licensed to Telenav by third party vendors for the benefit of you and other end users. This Agreement includes end-user terms applicable to these companies (included at the end of this Agreement), and thus your use of the Telenav Software is also subject to such terms. You agree to comply with the following additional terms and conditions, which are applicable to Telenav's third party vendor licensors::

### 9.1 End User Terms Required by HERE North America, LLC

The data ("Data") is provided for your personal, internal use only and not for resale. It is protected by copyright, and is subject to the following terms and conditions which are agreed to by you, on the one hand, and Telenav ("Telenav") and its licensors (including their licensors and suppliers) on the other hand.

© 2013 HERE. All rights reserved.

The Data for areas of Canada includes information taken with permission from Canadian authorities, including: © Her Majesty the Queen in Right of Canada, © Queen's Printer for Ontario, © Canada Post Corporation, GeoBase®, © Department of Natural Resources Canada.

HERE holds a non-exclusive license from the United States Postal Service® to publish and sell ZIP+4® information.

©United States Postal Service® 2014. Prices are not established, controlled or approved by the United States Postal Service®. The following trademarks and registrations are owned by the USPS: United States Postal Service, USPS, and ZIP+4

The Data for Mexico includes certain data from Instituto Nacional de Estadística y Geografía.

### 9.2 End User Terms Required by NAV2 (Shanghai) Co., Ltd

The data ("Data") is provided for your personal, internal use only and not for resale. It is protected by copyright, and is subject to the following terms and conditions which are agreed to by you, on the one hand, and NAV2 (Shanghai) Co., Ltd ("NAV2") and its licensors (including their licensors and suppliers) on the other hand. 20xx. All rights reserved

### Terms and Conditions

**Permitted Use.** You agree to use this Data together with the Telenav Software solely for the internal business and personal purposes for which you were licensed, and not for service bureau, time-sharing or other similar purposes. Accordingly, but subject to the restrictions set forth in the following paragraphs, you agree not to otherwise reproduce, copy, modify, decompile, disassemble, create any derivative works of, or reverse engineer any portion of this Data, and may not transfer or distribute it in any form, for any purpose, except to the extent permitted by mandatory laws.

## Appendices

---

**Restrictions.** Except where you have been specifically licensed to do so by Telenav, and without limiting the preceding paragraph, you may not use this Data (a) with any products, systems, or applications installed or otherwise connected to or in communication with vehicles, capable of vehicle navigation, positioning, dispatch, real time route guidance, fleet management or similar applications; or (b) with or in communication with any positioning devices or any mobile or wireless-connected electronic or computer devices, including without limitation cellular phones, palmtop and handheld computers, pagers, and personal digital assistants or PDAs.

**Warning.** The Data may contain inaccurate or incomplete information due to the passage of time, changing circumstances, sources used and the nature of collecting comprehensive geographic data, any of which may lead to incorrect results.

**No Warranty.** This Data is provided to you “as is,” and you agree to use it at your own risk. Telenav and its licensors (and their licensors and suppliers) make no guarantees, representations or warranties of any kind, express or implied, arising by law or otherwise, including but not limited to, content, quality, accuracy, completeness, effectiveness, reliability, fitness for a particular purpose, usefulness, use or results to be obtained from this Data, or that the Data or server will be uninterrupted or error-free.

**Disclaimer of Warranty:** TELENAV AND ITS LICENSORS (INCLUDING THEIR LICENSORS AND SUPPLIERS) DISCLAIM ANY WARRANTIES, EXPRESS OR IMPLIED, OF QUALITY, PERFORMANCE, MERCHANTABILITY, FITNESS FOR A

PARTICULAR PURPOSE OR NON-INFRINGEMENT. Some States, Territories and Countries do not allow certain warranty exclusions, so to that extent the above exclusion may not apply to you.

**Disclaimer of Liability:** TELENAV AND ITS LICENSORS (INCLUDING THEIR LICENSORS AND SUPPLIERS) SHALL NOT BE LIABLE TO YOU: IN RESPECT OF ANY CLAIM, DEMAND OR ACTION, IRRESPECTIVE OF THE NATURE OF THE CAUSE OF THE CLAIM, DEMAND OR ACTION ALLEGING ANY LOSS, INJURY OR DAMAGES, DIRECT OR INDIRECT, WHICH MAY RESULT FROM THE USE OR POSSESSION OF THE INFORMATION; OR FOR ANY LOSS OF PROFIT, REVENUE, CONTRACTS OR SAVINGS, OR ANY OTHER DIRECT, INDIRECT, INCIDENTAL, SPECIAL OR CONSEQUENTIAL DAMAGES ARISING OUT OF YOUR USE OF OR INABILITY TO USE THIS INFORMATION, ANY DEFECT IN THE INFORMATION, OR THE BREACH OF THESE TERMS OR CONDITIONS, WHETHER IN AN ACTION IN CONTRACT OR TORT OR BASED ON A WARRANTY, EVEN IF TELENAV OR ITS LICENSORS HAVE BEEN ADVISED OF THE POSSIBILITY OF SUCH DAMAGES. Some States, Territories and Countries do not allow certain liability exclusions or damages limitations, so to that extent the above may not apply to you.

**Export Control.** You shall not export from anywhere any part of the Data or any direct product thereof except in compliance with, and with all licenses and approvals required under, applicable export laws, rules and regulations, including but not limited to the laws, rules and regulations administered by the Office of Foreign Assets Control of the U.S. Department of Commerce and the Bureau of Industry and Security of the U.S. Department of Commerce. To the extent that any such

# Appendices

export laws, rules or regulations prohibit HERE from complying with any of its obligations hereunder to deliver or distribute Data, such failure shall be excused and shall not constitute a breach of this Agreement.

**Entire Agreement.** These terms and conditions constitute the entire agreement between Telenav (and its licensors, including their licensors and suppliers) and you pertaining to the subject matter hereof, and supersedes in their entirety any and all written or oral agreements previously existing between us with respect to such subject matter.

**Governing Law.** The above terms and conditions shall be governed by the laws of the State of Illinois [insert "Netherlands" where European HERE Data is used], without giving effect to (i) its conflict of laws provisions, or (ii) the United Nations Convention for Contracts for the International Sale of Goods, which is explicitly excluded. You agree to submit to the jurisdiction of the State of Illinois [insert "The Netherlands" where European HERE Data is used] for any and all disputes, claims and actions arising from or in connection with the Data provided to you hereunder.

**Government End Users.** If the Data is being acquired by or on behalf of the United States government or any other entity seeking or applying rights similar to those customarily claimed by the United States government, this Data is a "commercial item" as that term is defined at 48 C.F.R. ("FAR") 2.101, is licensed in accordance with these End-User Terms, and each copy of Data delivered or otherwise furnished shall be marked and embedded as appropriate with the following "Notice of Use," and shall be treated in accordance with such Notice:

NOTICE OF USE
CONTRACTOR (MANUFACTURER/SUPPLIER) NAME: HERE
CONTRACTOR (MANUFACTURER/SUPPLIER) ADDRESS: c/o Nokia, 425 West Randolph Street, Chicago, Illinois 60606
This Data is a commercial item as defined in FAR 2.101 and is subject to these End-User Terms under which this Data was provided.
© 1987 – 2014 HERE – All rights reserved.

If the Contracting Officer, federal government agency, or any federal official refuses to use the legend provided herein, the Contracting Officer, federal government agency, or any federal official must notify HERE prior to seeking additional or alternative rights in the Data.

## I. US/Canada Territory

A. United States Data. The End-User Terms for any Application containing Data for the United States shall contain the following notices:

"HERE holds a non-exclusive license from the United States Postal Service® to publish and sell ZIP+4® information."

"©United States Postal Service® 20XX. Prices are not established, controlled or approved by the United States Postal Service®. The following trademarks and registrations are owned by the USPS: United States Postal Service, USPS, and ZIP+4."

# Appendices

---

B. Canada Data. The following provisions apply to the Data for Canada, which may include or reflect data from third party licensors (“Third Party Data”), including Her Majesty the Queen in Right of Canada (“Her Majesty”), Canada Post Corporation (“Canada Post”) and the Department of Natural Resources of Canada (“NRCan”):

1. Disclaimer and Limitation: Client agrees that its use of the Third Party Data is subject to the following provisions:

a. Disclaimer: The Third Party Data is licensed on an “as is” basis. The licensors of such data, including Her Majesty, Canada Post and NRCan, make no guarantees, representations or warranties respecting such data, either express or implied, arising by law or otherwise, including but not limited to, effectiveness, completeness, accuracy or fitness for a particular purpose.

b. Limitation on Liability: The Third Party Data licensors, including Her Majesty, Canada Post and NRCan, shall not be liable: (i) in respect of any claim, demand or action, irrespective of the nature of the cause of the claim, demand or action alleging any loss, injury or damages, direct or indirect, which may result from the use or possession of such Data; or (ii) in any way for loss of revenues or contracts, or any other consequential loss of any kind resulting from any defect in the Data.

2. Copyright Notice: In connection with each copy of all or any portion of the Data for the Territory of Canada, Client shall affix in a conspicuous manner the following copyright notice on at least one of: (i) the label for the storage media of the copy; (ii) the packaging for the copy; or (iii) other materials packaged with the copy, such as user manuals or end user license agreements: “This data includes information taken with permission from Canadian authorities, including © Her Majesty the Queen in Right of Canada, © Queen’s Printer for Ontario, © Canada Post Corporation, GeoBase®, © The Department of Natural Resources Canada. All rights reserved.”

3. End-User Terms: Except as otherwise agreed by the parties, in connection with the provision of any portion of the Data for the Territory of Canada to End-Users as may be authorized under the Agreement, Client shall provide such End-Users, in a reasonably conspicuous manner, with terms (set forth with other end user terms required to be provided under the Agreement, or as otherwise may be provided, by Client) which shall include the following provisions on behalf of the Third Party Data licensors, including Her Majesty, Canada Post and NRCan:

The Data may include or reflect data of licensors, including Her Majesty the Queen in the Right of Canada (“Her Majesty”), Canada Post Corporation (“Canada Post”) and the Department of Natural Resources Canada (“NRCan”). Such data is licensed on an “as is” basis. The licensors, including Her Majesty, Canada Post and NRCan, make no guarantees, representations or warranties respecting such data,

# Appendices

---

either express or implied, arising by law or otherwise, including but not limited to, effectiveness, completeness, accuracy or fitness for a particular purpose. The licensors, including Her Majesty, Canada Post and NRCan, shall not be liable in respect of any claim, demand or action, irrespective of the nature of the cause of the claim, demand or action alleging any loss, injury or damages, direct or indirect, which may result from the use or possession of the data or the Data. The licensors, including Her Majesty, Canada Post and NRCan, shall not be liable in any way for loss of revenues or contracts, or any other consequential loss of any kind resulting from any defect in the data or the Data.

End User shall indemnify and save harmless the licensors, including Her Majesty, Canada Post and NRCan, and their officers, employees and agents from and against any claim, demand or action, irrespective of the nature of the cause of the claim, demand or action, alleging loss, costs, expenses, damages or injuries (including injuries resulting in death) arising out of the use or possession of the data or the Data.

4. Additional Provisions: The terms contained in this Section are in addition to all of the rights and obligations of the parties under the Agreement. To the extent that any of the provisions of this Section are inconsistent with, or conflict with, any other provisions of the Agreement, the provisions of this Section shall prevail.

II. Mexico. The following provision applies to the Data for Mexico, which includes certain data from the Instituto Nacional de Estadística y Geografía (“INEGI”):

A. Any and all copies of the Data and/or packaging containing Data for Mexico shall contain the following notice: “Fuente: INEGI (Instituto Nacional de Estadística y Geografía)”

III. Latin America Territory

A. Third Party Notices. Any and all copies of the Data and/or packaging relating thereto shall include the respective Third Party Notices set forth below and used as described below corresponding to the Territory (or portion thereof) included in such copy:

Territory Notice

Argentina IGN “INSTITUTO GEOGRAFICO NACIONAL ARGENTINO”

Ecuador “INSTITUTO GEOGRAFICO MILITAR DEL ECUADOR AUTORIZACION N° IGM-2011-01- PCO-01 DEL 25 DE ENERO DE 2011”  
“source: © IGN 2009 - BD TOPO ®”

Guadeloupe, French Guiana and Martinique Mexico “Fuente: INEGI (Instituto Nacional de Estadística y Geografía)”

IV. Middle East Territory



# Appendices

---

A. Third Party Notices. Any and all copies of the Data and/or packaging relating thereto shall include the respective Third Party Notices set forth below and used as described below corresponding to the Territory (or portion thereof) included in such copy:

Country Notice

Jordan “© Royal Jordanian Geographic Centre”. The foregoing notice requirement for Jordan Data is a material term of the Agreement. If Client or any of its permitted sublicensees (if any) fail to meet such requirement, HERE shall have the right to terminate Client’s license with respect to the Jordan Data.

B. Jordan Data. Client and its permitted sublicensees (if any) are restricted from licensing and/or otherwise distributing HERE’s database for the country of Jordan (“Jordan Data”) for use in Enterprise Applications to (i) non-Jordanian entities for use of the Jordan Data solely in Jordan or (ii) Jordan-based customers. In addition, Client, its permitted sublicensees (if any) and End-Users are restricted from using the Jordan Data in Enterprise Applications if such party is (i) a non-Jordanian entity using the Jordan Data solely in Jordan or (ii) a Jordan-based customer. For purposes of the foregoing, “Enterprise Applications” shall mean Geomarketing applications, GIS applications, mobile business asset management applications, call center applications, telematics applications, public organization Internet applications or for providing geocoding services.

## V. Europe Territory

### A. Use of Certain Traffic Codes in Europe

1. General Restrictions Applicable to Traffic Codes. Client acknowledges and agrees that in certain countries of the Europe Territory, Client will need to obtain rights directly from third party RDS-TMC code providers to receive and use the Traffic Codes in the Data and to deliver to End-Users Transactions in any way derived from or based on such Traffic Codes. For such countries, HERE shall deliver the Data incorporating Traffic Codes to Client only after receiving certification from Client of its having obtained such rights.

2. Display of Third Party Rights Legends for Belgium. Client shall, for each Transaction that uses Traffic Codes for Belgium, provide the following notice to the End-User: “Traffic Codes for Belgium are provided by the Ministerie van de Vlaamse Gemeenschap and the Ministère de l’Equipeement et des Transports.”

B. Paper Maps. With respect to any license granted to Client relating to making, selling or distributing paper maps (i.e., a map fixed on a paper or paper-like medium): (a) such license with respect to Data for the Territory of Great Britain is conditioned on Client’s entering into and complying with a separate written agreement with the Ordnance Survey (“OS”) to create and sell paper maps, Client’s paying to the OS any and all applicable paper map royalties, and Client’s complying with the OS copyright notice requirements; (b) such license for selling or otherwise distributing for charge with respect to Data for the Territory of Czech Republic

# Appendices

is conditioned on Client's obtaining prior written consent from Kartografie a.s.; (c) such license for selling or distributing with respect to Data for the Territory of Switzerland is conditioned on Client's obtaining a permit from Bundesamt für Landestopografie of Switzerland; (d) Client is restricted from using Data for the Territory of France to create paper maps with a scale between 1:5,000 and 1:250,000; and (e) Client is restricted from using any Data to create, sell or distribute paper maps that are the same or substantially similar, in terms of data content and specific use of color, symbols and scale, to paper maps published by the European national mapping agencies, including without limitation, Landervermessungämter of Germany, Topografische Dienst of the Netherlands, Nationaal Geografisch Instituut of Belgium, Bundesamt für Landestopografie of Switzerland, Bundesamt für Eich- und Vermessungswesen of Austria, and the National Land Survey of Sweden.

C. OS Enforcement. Without limiting Section IV(B) above, with respect to Data for the Territory of Great Britain, Client acknowledges and agrees that the Ordnance Survey ("OS") may bring a direct action against Client to enforce compliance with the OS copyright notice (see Section IV(D) below) and paper map requirements (see Section IV(B) above) contained in this Agreement.

D. Third Party Notices. Any and all copies of the Data and/or packaging relating thereto shall include the respective Third Party Notices set forth below and used as described below corresponding to the Territory (or portion thereof) included in such copy:

Country(ies) Notice

Austria	"© Bundesamt für Eich- und Vermessungswesen"
Croatia Cyprus, Estonia, Latvia, Lithuania, Moldova, Poland, Slovenia and/or Ukraine	"© EuroGeographics"
France	"source: © IGN 2009 – BD TOPO ®"
Germany	"Die Grundlagendaten wurden mit Genehmigung der zuständigen Behörden entnommen"
Great Britain	"Contains Ordnance Survey data © Crown copyright and database right 2010 Contains Royal Mail data © Royal Mail copyright and database right 2010"
Greece	"Copyright Geomatics Ltd."
Hungary	"Copyright © 2003; Top-Map Ltd."
Italy	"La Banca Dati Italiana è stata prodotta usando quale riferimento anche cartografia numerica ed al tratto prodotta e fornita dalla Regione Toscana."
Norway	"Copyright © 2000; Norwegian Mapping Authority"
Portugal	"Source: IgeoE – Portugal"

# Appendices

Spain	“Información geográfica propiedad del CNIG”
Sweden	“Based upon electronic data © National Land Survey Sweden.”
Switzerland	“Topografische Grundlage: © Bundesamt für Landestopographie.

E. Respective Country Distribution. Client acknowledges that HERE has not received approvals to distribute map data for the following countries in such respective countries: Albania, Belarus, Kyrgyzstan, Moldova and Uzbekistan. HERE may update such list from time to time. The license rights granted to Client under this TL with respect to the Data for such countries are contingent upon Client's compliance with all applicable laws and regulations, including, without limitation, any required licenses or approvals to distribute the Application incorporating such Data in such respective countries.

## VI. Australia Territory

A. Third Party Notices. Any and all copies of the Data and/or packaging relating thereto shall include the respective Third Party Notices set forth below and used as described below corresponding to the Territory (or portion thereof) included in such copy:

Copyright. Based on data provided under license from PSMA Australia Limited ([www.pasma.com.au](http://www.pasma.com.au)).

Product incorporates data which is © 20XX Telstra Corporation Limited, GM Holden Limited, Intelomatics Australia Pty Ltd and Continental Pty Ltd.

B. Third Party Notices for Australia. In addition to the foregoing, the End-User Terms for any Application containing RDS-TMC Traffic Codes for Australia shall contain the following notice: “Product incorporates traffic location codes which is © 20XX Telstra Corporation Limited and its licensors.”

## **AT&T Vehicle Network Carrier Telematics Disclosure**

END USER FOR PURPOSES OF THIS SECTION MEANS YOU AND YOUR HEIRS, EXECUTORS, LEGAL PERSONAL REPRESENTATIVES AND PERMITTED ASSIGNS. FOR PURPOSES OF THIS SECTION “UNDERLYING WIRELESS SERVICE CARRIER” INCLUDES ITS AFFILIATES AND CONTRACTORS AND THEIR RESPECTIVE OFFICERS, DIRECTORS, EMPLOYEES, SUCCESSORS AND ASSIGNS. END USER HAS NO CONTRACTUAL RELATIONSHIP WITH THE UNDERLYING WIRELESS SERVICE CARRIER AND END USER IS NOT A THIRD PARTY BENEFICIARY OF ANY AGREEMENT BETWEEN FORD AND UNDERLYING CARRIER. END USER UNDERSTANDS AND AGREES THAT THE UNDERLYING CARRIER HAS NO LEGAL, EQUITABLE, OR OTHER LIABILITY OF ANY KIND TO END USER. IN ANY EVENT, REGARDLESS OF THE FORM OF THE ACTION, WHETHER FOR BREACH OF CONTRACT, WARRANTY, NEGLIGENCE, STRICT LIABILITY IN TORT OR OTHERWISE, END USER'S EXCLUSIVE REMEDY FOR CLAIMS ARISING IN ANY WAY IN CONNECTION WITH THIS AGREEMENT, FOR ANY CAUSE WHATSOEVER, INCLUDING BUT NOT LIMITED TO ANY FAILURE OR

# Appendices

---

DISRUPTION OF SERVICE PROVIDED HEREUNDER, IS LIMITED TO PAYMENT OF DAMAGES IN AN AMOUNT NOT TO EXCEED THE AMOUNT PAID BY END USER FOR THE SERVICES DURING THE TWO-MONTH PERIOD PRECEDING THE DATE THE CLAIM AROSE.

(ii) END USER AGREES TO INDEMNIFY AND HOLD HARMLESS THE UNDERLYING WIRELESS SERVICE CARRIER AND ITS OFFICERS, EMPLOYEES, AND AGENTS AGAINST ANY AND ALL CLAIMS, INCLUDING WITHOUT LIMITATION CLAIMS FOR LIBEL, SLANDER, OR ANY PROPERTY DAMAGE, PERSONAL INJURY OR DEATH, ARISING IN ANY WAY, DIRECTLY OR INDIRECTLY, IN CONNECTION WITH THIS AGREEMENT OR THE USE, FAILURE TO USE, OR INABILITY TO USE THE DEVICE EXCEPT WHERE THE CLAIMS RESULT FROM THE UNDERLYING CARRIER'S GROSS NEGLIGENCE OR WILLFUL MISCONDUCT. THIS INDEMNITY WILL SURVIVE THE TERMINATION OF THE AGREEMENT.

(iii) END USER HAS NO PROPERTY RIGHT IN ANY NUMBER ASSIGNED TO THE DEVICE.

(iv) END USER UNDERSTANDS THAT FORD AND THE UNDERLYING CARRIER CANNOT GUARANTY THE SECURITY OF WIRELESS TRANSMISSIONS, AND WILL NOT BE LIABLE FOR ANY LACK OF SECURITY RELATING TO THE USE OF THE SERVICES

THE SERVICE IS FOR [END USER'S] USE ONLY AND END USER MAY NOT RESELL THE SERVICE TO ANY OTHER PARTY END USER UNDERSTANDS THAT THE UNDERLYING CARRIER DOES NOT GUARANTEE ANY END USER UNINTERRUPTED SERVICE OR COVERAGE. THE UNDERLYING CARRIER DOES NOT WARRANT THAT END USERS CAN OR WILL BE LOCATED USING THE SERVICE. THE UNDERLYING CARRIER

MAKES NO WARRANTY, EXPRESS OR IMPLIED, OF MERCHANTABILITY OR FITNESS FOR A PARTICULAR PURPOSE, SUITABILITY, OR PERFORMANCE REGARDING ANY SERVICES OR GOODS, AND IN NO EVENT SHALL AT&T BE LIABLE, WHETHER OR NOT DUE TO ITS OWN NEGLIGENCE, FOR ANY: (A) ACT OR OMISSION OF A THIRD PARTY; (B) MISTAKES, OMISSIONS, INTERRUPTIONS, ERRORS, FAILURES TO TRANSMIT, DELAYS, OR DEFECTS IN THE SERVICE PROVIDED BY OR THROUGH THE UNDERLYING CARRIER; (C) DAMAGE OR INJURY CAUSED BY SUSPENSION OR TERMINATION BY THE UNDERLYING CARRIER; OR (D) DAMAGE OR INJURY CAUSED BY A FAILURE OR DELAY IN CONNECTING A CALL TO ANY ENTITY, INCLUDING 911 OR ANY OTHER EMERGENCY SERVICE. TO THE FULL EXTENT ALLOWED BY LAW, THE END USER RELEASES, INDEMNIFIES AND HOLDS THE UNDERLYING CARRIER HARMLESS FROM AND AGAINST ANY AND ALL CLAIMS OF ANY PERSON OR ENTITY FOR DAMAGES OF ANY NATURE ARISING IN ANY WAY FROM OR RELATING TO, DIRECTLY OR INDIRECTLY, SERVICES PROVIDED BY THE UNDERLYING CARRIER OR ANY PERSON'S USE THEREOF, INCLUDING CLAIMS ARISING IN WHOLE OR IN PART FROM THE ALLEGED NEGLIGENCE OF THE UNDERLYING CARRIER.

## **VII. China Territory**

### ***Personal Use Only***

You agree to use this Data together with [insert name of Client Application] for the solely personal, non-commercial purposes for which you were licensed, and not for service bureau, time-sharing or other similar purposes. Accordingly, but subject to the restrictions set forth in the following paragraphs, you may copy this Data only as necessary for your personal use to (i)

# Appendices

---

view it, and (ii) save it, provided that you do not remove any copyright notices that appear and do not modify the Data in any way. You agree not to otherwise reproduce, copy, modify, decompile, disassemble or reverse engineer any portion of this Data, and may not transfer or distribute it in any form, for any purpose, except to the extent permitted by mandatory laws.

## **Restrictions**

Except where you have been specifically licensed to do so by NAV2, and without limiting the preceding paragraph, you may not (a) use this Data with any products, systems, or applications installed or otherwise connected to or in communication with vehicles, capable of vehicle navigation, positioning, dispatch, real time route guidance, fleet management or similar applications; or (b) with or in communication with any positioning devices or any mobile or wireless-connected electronic or computer devices, including without limitation cellular phones, palmtop and handheld computers, pagers, and personal digital assistants or PDAs. You agree to cease using this Data if you fail to comply with these terms and conditions.

## **Limited Warranty**

NAV2 warrants that (a) the Data will perform substantially in accordance with the accompanying written materials for a period of ninety (90) days from the date of receipt, and (b) any support services provided by NAV2 shall be substantially as described in applicable written materials provided to you by NAV2, and NAV2's support engineers will make commercially reasonable efforts to solve any problem issues.

## **rigCustomer Remedies**

NAV2 and its suppliers' entire liability and your exclusive remedy shall be, at NAV2's sole discretion, either (a) return of the price paid, if any, or (b) repair or replacement of the Data that do not meet NAV2's Limited Warranty and that are returned to NAV2 with a copy of your receipt. This Limited Warranty is void if failure of the Data has resulted from accident, abuse, or misapplication. Any replacement Data will be warranted for the remainder of the original warranty period or thirty (30) days, whichever is longer. Neither these remedies nor any product support services offered by NAV2 are available without proof of purchase from an authorized international source.

## **No Other Warranty:**

EXCEPT FOR THE LIMITED WARRANTY SET FORTH ABOVE AND TO THE EXTENT PERMITTED BY APPLICABLE LAW, NAV2 AND ITS LICENSORS (INCLUDING THEIR LICENSORS AND SUPPLIERS) DISCLAIM ANY WARRANTIES, EXPRESS OR IMPLIED, OF QUALITY, PERFORMANCE, MERCHANTABILITY, FITNESS FOR A PARTICULAR PURPOSE, OWNERSHIP OR NON-INFRINGEMENT. Certain warranty exclusions may not be permitted under applicable law, so to that extent the above exclusion may not apply to you.

## **Limited Liability:**

TO THE EXTENT PERMITTED BY APPLICABLE LAW, NAV2 AND ITS LICENSORS (INCLUDING THEIR LICENSORS AND SUPPLIERS) SHALL NOT BE LIABLE TO YOU: IN RESPECT OF ANY CLAIM, DEMAND OR ACTION, IRRESPECTIVE OF THE NATURE OF THE CAUSE OF THE CLAIM, DEMAND OR ACTION ALLEGING ANY LOSS, INJURY OR DAMAGES, DIRECT OR INDIRECT, WHICH MAY RESULT FROM THE USE OR POSSESSION OF THE INFORMATION; OR

# Appendices

---

FOR ANY LOSS OF PROFIT, REVENUE, CONTRACTS OR SAVINGS, OR ANY OTHER DIRECT, INDIRECT, INCIDENTAL, SPECIAL OR CONSEQUENTIAL DAMAGES ARISING OUT OF YOUR USE OF OR INABILITY TO USE THIS INFORMATION, ANY DEFECT IN THE INFORMATION, OR THE BREACH OF THESE TERMS OR CONDITIONS, WHETHER IN AN ACTION IN CONTRACT OR TORT OR BASED ON A WARRANTY, EVEN IF NAV2 OR ITS LICENSORS HAVE BEEN ADVISED OF THE POSSIBILITY OF SUCH DAMAGES. UNDER NO CIRCUMSTANCES SHALL NAV2'S OR ITS SUPPLIERS' LIABILITY HEREUNDER EXCEED THE PRICE PAID. Certain liability exclusions may not be permitted under applicable law, so to that extent the above exclusion may not apply to you.

## **Export Control**

You agree not to export to anywhere any part of the Data provided to you or any direct product thereof except in compliance with, and with all licenses and approvals required under, applicable export laws, rules and regulations.

## **IP Protection**

The Data are owned by NAV2 or its suppliers and are protected by applicable copyright and other intellectual property law and treaties. The Data are provided solely on the basis of a license to use, not sale.

## **Entire Agreement**

These terms and conditions constitute the entire agreement between NAV2 (and its licensors, including their licensors and suppliers) and you pertaining to the subject matter hereof, and supersedes in their entirety any and all written or oral agreements previously existing between us with respect to such subject matter.

## **Governing Law.**

The above terms and conditions shall be governed by the laws of the People's Republic of China, without giving effect to (i) its conflict of laws provisions, or (ii) the United Nations Convention for Contracts for the International Sale of Goods, which is explicitly excluded. Any dispute arising from or in connection with the Data provided to you hereunder shall be submitted to the Shanghai International Economic and Trade Arbitration Commission for arbitration.

## **Gracenote® Copyright**

CD and music-related data from Gracenote, Inc., copyright©

2000-2007 Gracenote. Gracenote Software, copyright © 2000-2007 Gracenote. This product and service may practice one or more of the following U.S. Patents 5,987,525; 6,061,680; 6,154,773; 6,161,132; 6,230,192; 6,230,207; 6,240,459; 6,330,593 and other patents issued or pending. Some services supplied under license from Open Globe, Inc. for U.S. Patent 6,304,523.

Gracenote and CDDB are registered trademarks of Gracenote. The Gracenote logo and logotype, and the "Powered by Gracenote™" logo are trademarks of Gracenote.

## **Gracenote® End User License Agreement (EULA)**

This device contains software from Gracenote, Inc. of 2000 Powell Street Emeryville, California 94608 ("Gracenote").

The software from Gracenote (the "Gracenote Software") enables this device to do disc and music file identification and obtain music-related information, including name, artist, track, and title information ("Gracenote Data") from online servers

## Appendices

---

("Gracenote Servers"), and to perform other functions. You may use Gracenote Data only by means of the intended End User functions of this device. This device may contain content belonging to Gracenote's providers. If so, all of the restrictions set forth herein with respect to Gracenote Data shall also apply to such content and such content providers shall be entitled to all of the benefits and protections set forth herein that are available to Gracenote. You agree that you will use the content from Gracenote ("Gracenote Content"), Gracenote Data, the Gracenote Software, and Gracenote Servers for your own personal, non-commercial use only. You agree not to assign, copy, transfer or transmit the Gracenote Content, Gracenote Software or any Gracenote Data (except in a Tag associated with a music file) to any third party. YOU AGREE NOT TO USE OR EXPLOIT GRACENOTE CONTENT, GRACENOTE DATA, THE GRACENOTE SOFTWARE, OR GRACENOTE SERVERS, EXCEPT AS EXPRESSLY PERMITTED HEREIN.

You agree that your non-exclusive licenses to use the Gracenote Content, Gracenote Data, the Gracenote Software, and Gracenote Servers will terminate if you violate these restrictions. If your licenses terminate, you agree to cease any and all use of the Gracenote Content, Gracenote Data, the Gracenote Software, and Gracenote Servers.

Gracenote, respectively, reserve all rights in Gracenote Data, the Gracenote Software, and the Gracenote Servers and Gracenote Content, including all ownership rights. Under no circumstances will either Gracenote become liable for any payment to you for any information that you provide,

including any copyrighted material or music file information. You agree that Gracenote may enforce its respective rights, collectively or separately, under this agreement against you, directly in each company's own name.

Gracenote uses a unique identifier to track queries for statistical purposes. The purpose of a randomly assigned numeric identifier is to allow Gracenote to count queries without knowing anything about who you are. For more information, see the web page at [www.gracenote.com](http://www.gracenote.com) for the Gracenote Privacy Policy.

THE GRACENOTE SOFTWARE, EACH ITEM OF GRACENOTE DATA AND THE GRACENOTE CONTENT ARE LICENSED TO YOU "AS IS". NEITHER GRACENOTE MAKES ANY REPRESENTATIONS OR WARRANTIES, EXPRESS OR IMPLIED, REGARDING THE ACCURACY OF ANY GRACENOTE DATA FROM THE GRACENOTE SERVERS OR GRACENOTE CONTENT. GRACENOTE COLLECTIVELY AND SEPARATELY RESERVE THE RIGHT TO DELETE DATA AND/OR CONTENT FROM THE COMPANIES' RESPECTIVE SERVERS OR, IN THE CASE OF GRACENOTE, CHANGE DATA CATEGORIES FOR ANY CAUSE THAT GRACENOTE DEEMS SUFFICIENT. NO WARRANTY IS MADE THAT EITHER GRACENOTE CONTENT OR THE GRACENOTE SOFTWARE OR GRACENOTE SERVERS ARE ERROR-FREE OR THAT THE FUNCTIONING OF THE GRACENOTE SOFTWARE OR GRACENOTE SERVERS WILL BE UNINTERRUPTED. GRACENOTE IS NOT OBLIGATED TO PROVIDE YOU WITH ANY ENHANCED OR ADDITIONAL DATA TYPES THAT GRACENOTE MAY CHOOSE TO PROVIDE IN THE FUTURE AND IS FREE TO DISCONTINUE ITS ONLINE SERVICES AT ANY TIME. GRACENOTE DISCLAIMS ALL WARRANTIES EXPRESS OR IMPLIED, INCLUDING, BUT NOT LIMITED TO,

# Appendices

IMPLIED WARRANTIES OF MERCHANTABILITY, FITNESS FOR A PARTICULAR PURPOSE, TITLE, AND NON-INFRINGEMENT. NEITHER GRACENOTE WARRANTS THE RESULTS THAT WILL BE OBTAINED BY YOUR USE OF THE GRACENOTE SOFTWARE OR ANY GRACENOTE SERVER. IN NO CASE WILL GRACENOTE BE LIABLE FOR ANY CONSEQUENTIAL OR INCIDENTAL DAMAGES OR FOR ANY LOST PROFITS OR LOST REVENUES FOR ANY REASON WHATSOEVER. © Gracenote 2007.

## **Taiwan Territory**

Note: In accordance with the management approach of low-power radio wave radiation motors:

Article 12: For approved and certified low-power radiation motor models, companies, firms or users must not alter the frequency, increase the power or change the characteristics and functions of the original design without authorization.

Article 14: The usage of low-power radio-frequency motors must not affect aviation safety and interfere with legal telecommunications. Should interference be detected, immediately stop using the device and only resume usage after ensuring that there is no longer any interference. For the legal telecommunication and wireless telecommunication of the telco, the low-power radio frequency motor must be able to tolerate legal limits of interference from telecommunication, industrial, scientific and radio wave equipment.

## **SUNA TRAFFIC CHANNEL – TERMS AND CONDITIONS**

By activating, using and/or accessing the SUNA Traffic Channel, SUNA Predictive or other content or material provided by Intellematics (together, **SUNA Products and/or Services**), you must accept certain terms and conditions. The following is a brief summary of the terms and conditions that apply to you. To view the full terms and conditions relevant to your use of the SUNA Products and/or Services, please consult:

<b>Website</b>
<a href="http://www.sunattraffic.com.au/termsandconditions/">www.sunattraffic.com.au/termsandconditions/</a>

### **1. Acceptance**

By using SUNA Products and/or Services, you will be deemed to have accepted and agreed to be bound by the terms and conditions fully detailed at:

<b>Website</b>
<a href="http://www.sunattraffic.com.au/termsandconditions/">www.sunattraffic.com.au/termsandconditions/</a>

### **2. Intellectual Property**

SUNA Products and/or Services are for your personal use. You may not record, or retransmit the content, nor use the content in association with any other traffic information or route guidance service or device not approved by Intellematics. You obtain no right of ownership in any Intellectual Property Rights (including copyright) in the data that is used to provide SUNA Products and/or Services.

### **3. Appropriate Use**



# Appendices

SUNA Products and/or Services are intended as an aid to personal motoring and travel planning, and do not provide comprehensive or accurate information on all occasions. On occasions, you may experience additional delay as a result of using SUNA Products and/or Services. You acknowledge that it is not intended, or suitable, for use in applications where time of arrival or driving directions may impact the safety of the public or yourself.

## 4. Use of SUNA Products and Services while driving

You, and other authorised drivers of the vehicle in which SUNA Products and/or Services are available or installed and active, remain at all times responsible for observing all relevant laws and codes of safe driving. In particular, you agree to only actively operate SUNA Products and/or Services when the Vehicle is at a complete stop and it is safe to do so.

## 5. Service Continuity and Reception of the SUNA Traffic Channel

We will use reasonable endeavours to provide the SUNA Traffic Channel 24 hours a day, 365 days a year. The SUNA Traffic Channel may occasionally be unavailable for technical reasons or for planned maintenance. We will try to perform maintenance at times when congestion is light. We reserve the right to withdraw SUNA Products and/or Services at any time.

Also, we cannot assure the uninterrupted reception of the SUNA Traffic Channel RDS-TMC signal at any particular location.

## 6. Limitation of Liability

Neither Intelomatics (nor its suppliers or the manufacturer of your device (the “Suppliers”)) shall be liable to you or to any third party for any damages either direct, indirect, incidental, consequential or otherwise arising out of the use of or inability to use SUNA Products and/or Services even if Intelomatics or a Supplier has been advised of the possibility of such damages. You also acknowledge that the neither Intelomatics nor any Supplier guarantees nor make any warranties that relate to the availability, accuracy or completeness of SUNA Products and/or Services, and to the extent which it is lawful to do so, both Intelomatics and each Supplier excludes any warranties which might otherwise be implied by any State or Federal legislation in relation to SUNA Products and/or Services.

## 7. Please Note

Great care has been taken in preparing this manual. Constant product development may mean that some information is not entirely up-to-date. The information in this document is subject to change without notice.

# DECLARATION OF CONFORMITY - VEHICLES WITHOUT: SYNC 3

## Radio Frequency Statement

Component Name	FCC Identification Number	IC Identification Number
Audio Unit	NT8-AHUCHRFORD	3043A-AHUCHRFORD

# Appendices



**WARNING:** Changes or modifications not expressly approved by the party responsible for compliance could void the user's authority to operate the equipment. The term "IC:" before the radio certification number only signifies that Industry Canada technical specifications were met.

This device complies with Part 15 of the FCC Rules and with RSS-210 of Industry Canada. Operation is subject to the following two conditions:

1. The device does not cause harmful interference.
2. The device accepts any interference received, including interference that could cause undesired operation.

## DECLARATION OF CONFORMITY - VEHICLES WITH: SYNC 3

### Radio Frequency Statement

SYNC Version	FCC Identification Number	IC Identification Number
3.0	ACJ-SYNCG3-L	216B-SYNCG3-L
3.1	ACJ-FA-170-BCARHS	216B-FA170BCARHS
3.2	ACJ-FG-185-SG32MH	216B-FG185SG32MH



**WARNING:** Changes or modifications not expressly approved by the party responsible for compliance could void the user's authority to operate the equipment. The term "IC:" before the radio certification number only signifies that Industry Canada technical specifications were met.

These devices comply with Part 15 of the FCC Rules and with RSS-210 of Industry Canada. Operation is subject to the following two conditions:

1. The device does not cause harmful interference.
2. The device accepts any interference received, including interference that could cause undesired operation.

## DECLARATION OF CONFORMITY - VEHICLES WITH: WIRELESS ACCESSORY CHARGING



**WARNING:** Changes or modifications not expressly approved by the party responsible for compliance could void the user's authority to operate the equipment. The term "IC:" before the radio certification number only signifies that Industry Canada technical specifications were met.

# Appendices

---

<b>Component Name</b>	<b>FCC Identification Number</b>
Wireless accessory charger.	L2C0066T

This equipment has been tested and found to comply with Part 18 of the FCC Rules.

This equipment generates, uses, and can radiate radio frequency energy and may cause harmful interference to radio communications. There is no guarantee that interference will not occur in a particular installation. If this equipment does cause harmful interference to radio or television reception, please consult the dealer.

This product is not end-user servicable.

This device complies with Industry Canada licence-exempt RSS standards. Operation is subject to the following two conditions:

1. The device does not cause harmful interference.
2. The device accepts any interference received, including interference that could cause undesired operation.

# Appendices

## TYPE APPROVALS

### Radio Frequency Certification Logos for Tire Pressure Monitoring Sensor(s)

Schrader AG2SZ4 Numero de Registro  
CNC: H-13498

E207816

Argentina



E197509

Brazil

Herby, Schrader Electronics UK Ltd.,  
declares that this TPMS is in compliance  
with the essential requirements and other  
provisions of directive 1999/5/EC. The  
declaration of conformity may be  
consulted at emcteam@schrader.co.uk

E207818

European Union EU

NCA APPROVED: 3R88M14030

E253824

Ghana

Kingdom of Jordan Type approval for tyre presse sensor  
Model : AG2SZ4  
Manufacturer:Schrader Electronics Ltd  
Type Approval Number:TRC/LPD/2014/56  
Equipment Type: Low Power Device (LPD)

E253823

Jordan



E253822

Malaysia

IFT: RLVSCMR15-1238

E253812

IFT: RLVSCMR15-1249

E253813

Mexico



E197811

# Appendices

Moldova



E207821

Morocco

**OMAN TRA**  
**TA-R/1752/14**  
**D090258**

E253817

Oman



**Type Approved**

**NTC**

**No:ESD-1408639C**

E198001

Philippines



E253816

Russia



E197844

Serbia

Complies with  
IDA Standards  
DA 105282

E253820

Singapore



**TA-2014/064**

**Approved**

E198002

South Africa



E253819

MSIP-CRM-SRD-AG2S24

South Korea

# Appendices

## Radio Frequency Certification Logos for Mid Range Radar



CCAM14LP0090T3

E203679

Taiwan



E253818

**109**

Ukraine

TRA  
REGISTERED NO:ER0130238/14  
DEALER NO:DA0047074/10

E207817

United Arab Emirates

MMR ID: C-20001

E269659

Argentina

MRR ID:  
NCA approved: 0R2-9H-7E1-x4D.

E269662

Ghana

MRR:  
Type Approval No.: TRC/LPD/2017/158  
Equipment Type: Low Power Device (LPD) ID: C-20001

E269660

Jordan

# Appendices

MRR ID:  
No. D'Agrement: MR 13639 ANRT 2017 (28 March 2017)

E269661

Morocco

MRR ID:  
TA-2017/370

E269664

South Africa

MRR ID:  
ER54071/17, Dealer License Number (WAC Dealer License Number: DA37380/15)

E269663

United Arab Emirates

## Radio Frequency Certification Logos for Passive Anti-Theft System

**CNC** COMISIÓN NACIONAL  
DE COMUNICACIONES

CNC ID: H-13170

E274065

Argentina

  
**ANATEL**  
MT-2821/2014

E269675

Brazil

AGREE PAR LE MCPT (REPUBLIQUE DE DJIBOUTI)  
Numéro d'agrément: 243/MCPT/SC/16  
Date d'agrément: 23/05/2016

E274068

Djibouti

# Appendices

---

NCA PRODUCT IDENTIFIER: NCA/TA/16/22

E269674

Ghana



E269673

Malaysia

This product has been Type Approved by Jamaica: SMA- OUC 11545917

E274067

Jamaica

N° D'AGRÉMENT: MR 8922 ANRT 2014

E269670

Morocco

Type approval No.: TRC/LPD/2013/235  
Equipment Type: Low Power Device (LPD)

E269666

Jordan



NR: 2012-11-1-0185

E274066

Paraguay



# Appendices



E275754

Pakistan



E269667

South Africa



E269672

Serbia



E269671

Ukraine

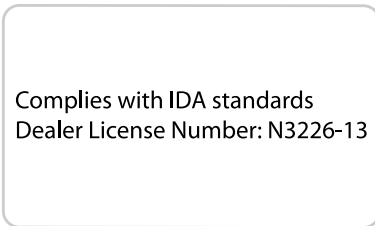

E269676

Singapore

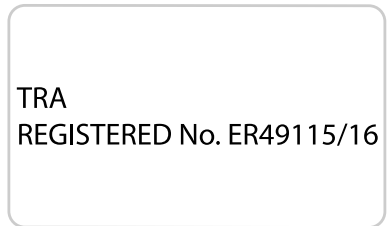

E269668

United Arab Emirates

# Appendices

So.No: A0364120416AF04A2



Type approval No.: TRC/LPD/2013/233  
Equipment Type: Low Power Device (LPD)

E269677

Vietnam

## Radio Frequency Certification Logos for Radio Transceiver Module

AGREE PAR LE MCPT (REPUBLIQUE DE DJIBOUTI)  
Numéro d'agrément: 247/MCPT/SC/16  
Date d'agrément: 23/05/2016

E272194

Jordan

N° D'AGRÉMENT: MR 12432 ANRT 2016

E272192

Djibouti

This product has been Type Approved by Jamaica:  
SMA – F03-AM315RX

E269683

Morocco



TAC NO: 14.1008/2015

E272193

Jamaica

E269684

Pakistan

# Appendices



E272195

Paraguay



E269682

Ukraine



E269681

Serbia

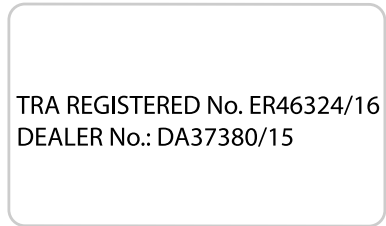

E272196

United Arab Emirates



E269685

South Africa

**Radio Frequency Certification  
Logos for Blind Spot Information  
System**

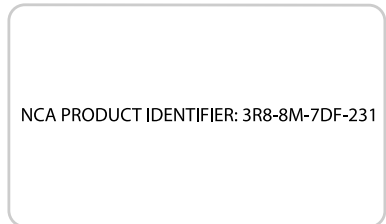

E269695

Ghana

# Appendices



E269697

Malaysia

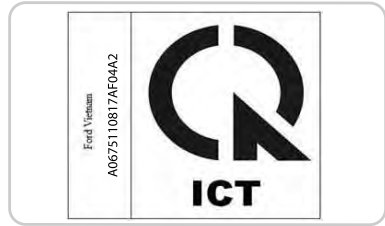

E269693

Vietnam

## Radio Frequency Certification Logos for Wireless Charging



E269696

South Africa

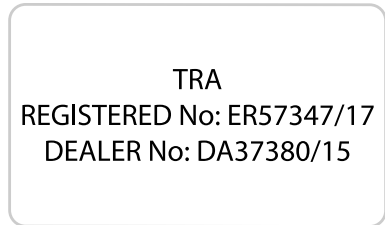

E272903

United Arab Emirates

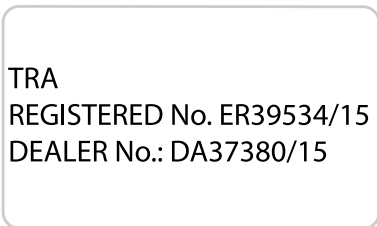

E269694

United Arab Emirates



E273475

South Korea

# Appendices

---

## Radio Frequency Certification Logos for SYNC 3



E252722

Brazil



# Index

## 9

911 Assist.....	49
911 Assist May Not Work If.....	50
911 Assist Privacy Notice.....	50
In the Event of a Crash.....	50

## A

A/C	
See: Climate Control.....	108
About This Manual.....	7
ABS	
See: Brakes.....	173
ABS driving hints	
See: Hints on Driving With Anti-Lock Brakes.....	174
Accessories.....	412
Exterior Style.....	412
Interior Style.....	412
Lifestyle.....	412
Peace of Mind.....	412
Accessories	
See: Replacement Parts Recommendation.....	13
ACC	
See: Using Adaptive Cruise Control.....	196
Active Park Assist.....	184
Using Active Park Assist.....	185
Adjusting the Headlamps.....	276
Horizontal Aim Adjustment.....	278
Vertical Aim Adjustment.....	276
Adjusting the Steering Wheel.....	74
Airbag Disposal.....	48
Air Conditioning	
See: Climate Control.....	108
Air Filter	
See: Changing the Engine Air Filter - 2.0L Duratec-HE (M14)/2.0L Flex Fuel, 1.5L Duratorq-TDCi Diesel.....	283
See: Changing the Engine Air Filter - 2.5L.....	283
Alarm	
See: Anti-Theft Alarm.....	72
AM/FM Radio - Vehicles Without: SYNC 3.....	358
Selecting a Radio Source.....	358
Anti-Theft Alarm.....	72
Alarm System.....	72
Arming the Alarm.....	72
Disarming the Alarm.....	73
Full Guard and Reduced Guard.....	72
Triggering the Alarm.....	72
Appendices.....	434
Apps.....	385
Using Apps on an Android Device.....	386
Using Apps on an iOS Device.....	385
At a Glance.....	17
Audible Warnings and Indicators.....	90
Airbag Secondary Warning Audible Warning.....	90
Automatic Transmission Audible Warning.....	90
Door Ajar Audible Warning.....	91
Fasten Seatbelt Audible Warning.....	91
Headlamps On Audible Warning.....	91
Key in Ignition Audible Warning.....	91
Parking Brake On Audible Warning.....	91
Audio System.....	352
General Information.....	352
Audio Unit Clock and Date Displays - Vehicles Without: SYNC 3.....	358
Adjusting the Clock.....	358
Audio Unit - Vehicles With: SYNC 3.....	356
Adjusting the Volume.....	356
Changing Radio Stations.....	357
Pausing or Playing Media.....	357
Scrolling Through the Menu Options.....	357
Seek Down and Previous Track Button.....	357
Seek Up and Next Track Button.....	357
Sound Settings.....	357
Switching the Audio Unit On and Off.....	356
Switching the Screen On and Off.....	357
Audio Unit - Vehicles Without: SYNC 3.....	353
Adjusting the Volume.....	353
Changing Radio Stations.....	354
Pausing or Playing Media.....	356
Returning to the Previous Screen.....	356
Scrolling Through the Menu Options.....	355
Seek Down and Previous Track Button.....	356
Seek Up and Next Track Button.....	356

# Index

Selecting a Menu Option.....	355	Automatic Transmission Fluid	
Selecting Media.....	354	Check.....	272
Selecting the Radio.....	354	Auto-Start-Stop.....	146
Sound Settings.....	356	Information Messages.....	147
Switching the Audio Unit On and Off.....	353	Principle of Operation.....	146
Switching the Screen On and Off.....	356	Replacing the Battery.....	147
System Settings.....	356	Switching the System On and Off.....	147
Using a Cell Phone.....	356	Using Auto-Start-Stop.....	146
Autolamps.....	79	Autowipers.....	75
Windshield Wiper Activated		Auxiliary Power Points.....	131
Headlamps.....	79	12 Volt DC Power Point.....	131
Automatic Climate Control.....	109	<b>B</b>	
Adjusting the Auto Mode.....	110	Battery	
Directing Air to the Footwell Air Vents.....	110	See: Changing the 12V Battery.....	273
Directing Air to the Instrument Panel Air		Blind Spot Information System.....	209
Vents.....	110	.....	209
Directing Air to the Windshield Air		Switching the System On and Off.....	210
Vents.....	110	System Errors.....	210
Setting the Blower Motor Speed.....	110	Using the Blind Spot Information	
Setting the Temperature.....	110	System.....	209
Switching Auto Mode On and Off.....	110	BLIS	
Switching Dual Mode On and Off.....	110	See: Blind Spot Information System.....	209
Switching Maximum Cooling On and		Bonnet Lock	
Off.....	110	See: Opening and Closing the Hood.....	261
Switching Maximum Defrost On and		Booster Seats.....	26
Off.....	109	Types of Booster Seats.....	27
Switching the Air Conditioning On and		Brake Fluid Check.....	272
Off.....	109	Brakes.....	173
Switching the Climate Control On and		General Information.....	173
Off.....	109	Breaking-In.....	238
Switching the Recirculated Air On and		Bulb Specification Chart.....	350
Off.....	109	<b>C</b>	
Automatic Crash Notification		Cabin Air Filter.....	113
System.....	49	Capacities and Specifications - 1.5L	
Automatic High Beam Control.....	80	Duratorq-TDCi Diesel.....	335
Automatic High Beam Indicator.....	81	Air Conditioning System.....	335
Overriding the System.....	81	Automatic Transmission.....	339
Switching the System On and Off.....	80	Brake System.....	339
Automatic Transmission - 6-Speed		Diesel Exhaust Fluid.....	338
Automatic Transmission.....	169	Engine.....	336
Brake Shift Interlock.....	169	Fuel Tank.....	338
Selector Lever Positions.....	169	Grease.....	340
SelectShift™.....	169	Locks.....	340
Automatic Transmission - 8-Speed		Washer Reservoir.....	338
Automatic Transmission.....	171		
Brake Shift Interlock.....	171		
Selector Lever Positions.....	171		
SelectShift™.....	171		



# Index

Capacities and Specifications - 2.0L	
Duratec-HE (M14)/2.0L Flex Fuel.....	340
Air Conditioning System.....	341
Automatic Transmission.....	344
Brake System.....	343
Engine.....	341
Fuel Tank.....	343
Grease.....	344
Locks.....	344
Washer Reservoir.....	343
Capacities and Specifications - 2.5L.....	345
Air Conditioning System.....	345
Automatic Transmission.....	349
Brake System.....	348
Engine.....	346
Fuel Tank.....	348
Grease.....	350
Locks.....	349
Washer Reservoir.....	348
Capacities and Specifications.....	327
Cargo Nets.....	222
Installing the Net.....	222
Removing the Net.....	224
Car Wash	
See: Cleaning the Exterior.....	287
Catalytic Converter.....	159
On-Board Diagnostics System.....	159
Changing a Bulb.....	278
Central High Mounted Brake Lamp.....	281
Front Fog Lamps.....	280
Headlamp.....	278
Interior Lamps.....	281
License Plate Lamp.....	281
Rear Lamps.....	281
Side Direction Indicator.....	280
Changing a Fuse.....	260
Fuse Types.....	260
General Information.....	260
Passenger Compartment Fuse Box.....	260
Changing a Road Wheel.....	320
Changing a Road Wheel.....	321
Dissimilar Spare Wheel and Tire Assembly Information.....	320
Stowing the Flat or Spare Tire.....	324
Changing the 12V Battery.....	273
Changing the Engine Air Filter - 2.0L Duratec-HE (M14)/2.0L Flex Fuel, 1.5L Duratorq-TDCi Diesel.....	283
Changing the Engine Air Filter - 2.5L.....	283
Changing the Front Wiper Blades.....	275
Changing the Rear Wiper Blades - Vehicles With: Manual Liftgate.....	275
Changing the Rear Wiper Blades - Vehicles With: Rear Cargo Doors.....	276
Checking MyKey System Status.....	60
Checking the Wiper Blades.....	275
Child Restraint and Seatbelt Maintenance.....	38
Child Restraint Positioning.....	28
Child Safety.....	18
General Information.....	18
Child Safety Locks.....	30
Left-Hand Side.....	31
Right-Hand Side.....	31
Cigar Lighter.....	131
Cleaning Leather Seats.....	291
Cleaning Products.....	286
Cleaning the Exterior.....	287
Cleaning the Headlamps.....	287
Exterior Chrome Parts.....	288
Exterior Plastic Parts.....	288
Stripes or Graphics.....	288
Underbody.....	288
Under Hood.....	288
Cleaning the Instrument Panel and Instrument Cluster Lens.....	290
Cleaning the Interior.....	289
Fabric, Carpets, Cloth Seats, Headliners and Floor Mats.....	289
Instrument Cluster Screens, LCD Screens and Radio Screens.....	290
Leather Interior.....	290
Rear Windows.....	290
Seatbelts.....	289
Storage Compartments, Cup Holders and Ashtrays.....	290
Suede Micro Fiber Fabric.....	290
Cleaning the Wheels.....	292
Cleaning the Windows and Wiper Blades.....	289
Clearing All MyKeys.....	60
MyKey Information Messages.....	60

# Index

Climate Control.....	108	Declaration of Conformity - Vehicles	
Clock.....	94	With: Wireless Accessory	
Type 1.....	94	Charging.....	462
Type 2.....	94	Declaration of Conformity - Vehicles	
Cold Weather Precautions.....	239	Without: SYNC 3.....	461
Connecting a Bluetooth Device -		Radio Frequency Statement.....	461
Vehicles Without: SYNC 3.....	358	Diesel Particulate Filter.....	163
Pairing a Device.....	358	Diesel Particulate Filter Automatic	
Coolant Check		Regeneration.....	164
See: Engine Coolant Check.....	268	Diesel Particulate Filter Manual	
Cornering Lamps.....	81	Regeneration.....	165
Crash Sensors and Airbag Indicator.....	47	On-Board Diagnostics System.....	163
Creating a MyKey - Vehicles With: Push		Direction Indicators.....	82
Button Start.....	57	Doors and Locks.....	63
MyKey Information Messages.....	58	Drive Belt Routing - 1.5L Duratorq-TDCi	
Creating a MyKey - Vehicles Without:		Diesel.....	284
Push Button Start.....	57	Drive Belt Routing - 2.0L Duratec-HE	
MyKey Information Messages.....	57	(MI4)/2.0L Flex Fuel.....	284
Cross Traffic Alert.....	211	Drive Belt Routing - 2.5L.....	285
False Alerts.....	213	Driver Alert.....	203
Switching the System Off and On.....	213	Driver Alert System Display.....	204
System Errors.....	213	Driver Alert System Messages.....	205
System Lights, Messages and Audible		Driver Alert System Warnings.....	203
Alerts.....	212	Switching Driver Alert On or Off.....	204
System Limitations.....	213	Driver and Passenger Airbags.....	41
Using the System.....	211	Children and Airbags.....	42
Cruise Control.....	195	Proper Driver and Front Passenger Seating	
Principle of Operation.....	195	Adjustment.....	41
Cruise control		Driver Knee Airbag.....	46
See: Using Cruise Control.....	195	Driving Aids.....	202
Cup Holders.....	133	Driving Hints.....	238
Customer Assistance.....	247	Driving Through Water.....	239
<b>D</b>		<b>E</b>	
Data Recording.....	9	Eco Mode.....	213
Comfort, Convenience and Entertainment		Eco Mode System Display.....	214
Data.....	11	Principle of Operation.....	213
Event Data.....	11	Economical Driving.....	238
Service Data.....	10	Electromagnetic Compatibility.....	434
Services That Third Parties Provide.....	12	Emission Law.....	158
Services That We Provide.....	12	Noise Emissions Warranty, Prohibited	
Vehicles With a Modem.....	12	Tampering Acts and Maintenance.....	159
Vehicles With SYNC.....	12	Tampering With a Noise Control	
Declaration of Conformity - Vehicles		System.....	158
With: SYNC 3.....	462	End User License Agreement.....	436
Radio Frequency Statement.....	462	VEHICLE SOFTWARE END USER LICENSE	
		AGREEMENT (EULA).....	436

# Index

Engine Block Heater.....	144
Using the Engine Block Heater.....	145
Engine Coolant Check.....	268
Adding Coolant.....	268
Coolant Change.....	270
Engine Coolant Temperature Management.....	271
Fail-Safe Cooling.....	270
Recycled Coolant.....	270
Severe Climates.....	270
Engine Cooling Fan - Diesel.....	268
Engine Cooling Fan - Gasoline.....	267
Engine Emission Control.....	158
Engine Immobilizer See: Passive Anti-Theft System.....	70
Engine Oil Check.....	266
Adding Engine Oil.....	266
Engine Oil Dipstick - 1.5L Duratorq-TDCi Diesel.....	265
Engine Oil Dipstick - 2.0L Duratec-HE (M14)/2.0L Flex Fuel/2.5L.....	266
Engine Specifications - 1.5L Duratorq-TDCi Diesel.....	327
Engine Specifications - 2.0L Duratec-HE (M14)/2.0L Flex Fuel.....	328
Engine Specifications - 2.5L.....	329
Entertainment.....	377
Playing Music From a USB or Media Player.....	378
Streaming Music From a Bluetooth Device.....	378
Using the Radio.....	377
Environment.....	16
Essential Towing Checks.....	233
Before Towing a Trailer.....	235
Hitches.....	234
Launching or Retrieving a Boat or Personal Watercraft.....	236
Safety Chains.....	234
Trailer Brakes.....	234
Trailer Lamps.....	235
Trailer Towing Connector.....	234
When Towing a Trailer.....	235
Event Data Recording See: Data Recording.....	9
Export Unique Options.....	15
Exterior Mirrors.....	84
Adjusting the Mirrors.....	84
Folding the Mirrors.....	84
<b>F</b>	
Fan See: Engine Cooling Fan - Diesel.....	268
See: Engine Cooling Fan - Gasoline.....	267
Fastening the Seatbelts.....	33
Seatbelt Locking Modes.....	34
Using Seatbelts During Pregnancy.....	34
Flat Tire See: Changing a Road Wheel.....	320
Flat Tire Inflation See: Tire Sealant and Inflator Kit.....	296
Floor Mats.....	239
Fog Lamps - Front See: Front Fog Lamps.....	81
Ford Credit.....	13
US Only.....	13
Ford Protect.....	414
Ford Protect Extended Service Plan (CANADA ONLY).....	415
Ford Protect Extended Service Plans (U.S. Only).....	414
Front Fog Lamps.....	81
Front Parking Aid.....	181
Front Parking Aid Information Messages.....	183
Object Distance Indicator.....	182
Front Passenger Sensing System.....	42
Front Wiper Blades See: Changing the Front Wiper Blades.....	275
Fuel and Refueling.....	148
Fuel Consumption.....	157
Advertised Capacity.....	157
Fuel Economy.....	157
Fuel Filler Funnel Location.....	153
Fuel Quality - Diesel.....	148
Biodiesel.....	149
Diesel Fuel Additives.....	150
Fuel Requirements - Choosing The Right Fuel: Vehicles Operated Where Ultra Low Sulfur Diesel Fuel Is Not Required.....	149
Fuel Requirements - Choosing The Right Fuel: Vehicles Operated Where Ultra Low Sulfur Diesel Fuel Is Required (United States/Canada/Puerto Rico/U.S. Virgin Islands And Other Locales).....	148

# Index

Fuel Quality - E85.....	152	Headlamp Exit Delay.....	80
Choosing the Right Fuel - Flex Fuel Vehicles.....	152	Headrest See: Head Restraints.....	115
Switching Between E85 and Gasoline.....	153	Head Restraints.....	115
Fuel Quality - Gasoline.....	151	Adjusting the Head Restraint.....	116
Choosing the Right Fuel.....	151	Heated Exterior Mirrors.....	113
Fuel Shutoff.....	242	Heated Rear Window.....	113
Ignition Switch.....	242	Heated Seats.....	130
Keyless Starting.....	243	Heated Windshield.....	113
Fuse Box Locations.....	254	Heating See: Climate Control.....	108
Engine Compartment Fuse Box.....	254	Hill Start Assist.....	174
Passenger Compartment Fuse Box.....	254	Switching the System On and Off.....	175
Fuses.....	254	Using Hill Start Assist.....	175
Fuse Specification Chart.....	254	Hints on Controlling the Interior Climate - Vehicles With: Automatic Temperature Control.....	111
Engine Compartment Fuse Box.....	255	Defogging or Clearing the Windshield of Thin Ice.....	111
Passenger Compartment Fuse Box.....	258	Defogging the Side Windows in Cold Weather.....	111
<b>G</b>		General Hints.....	111
Gauges.....	87	Quickly Cooling the Interior.....	111
Engine Coolant Temperature Gauge.....	88	Recommended Settings for Cooling.....	111
Fuel Gauge.....	87	Recommended Settings for Heating.....	111
Information Display.....	87	Hints on Controlling the Interior Climate - Vehicles With: Manual Temperature Control.....	112
Gearbox See: Transmission.....	169	Defogging or Clearing the Windshield of Thin Ice.....	112
General Information on Radio Frequencies.....	51	Defogging the Side Windows in Cold Weather.....	112
General Maintenance Information.....	416	General Hints.....	112
Multi-Point Inspection.....	418	Quickly Cooling the Interior.....	112
Owner Checks and Services.....	417	Quickly Heating the Interior.....	112
Protecting Your Investment.....	416	Recommended Settings for Cooling.....	112
Why Maintain Your Vehicle?.....	416	Recommended Settings for Heating.....	112
Why Maintain Your Vehicle at Your Dealership?.....	416	Hints on Driving With Anti-Lock Brakes.....	174
Getting Assistance Outside the U.S. and Canada.....	250	Home Screen.....	372
Getting the Services You Need.....	247	Hood Lock See: Opening and Closing the Hood.....	261
Away From Home.....	247	<b>I</b>	
Global Opening.....	84	Ignition Switch.....	134
<b>H</b>		In California (U.S. Only).....	248
Handbrake See: Parking Brake.....	174		
Hazard Flashers.....	242		
Headlamp Adjusting See: Adjusting the Headlamps.....	276		

# Index

Information Displays.....	92	Interior Mirror - Vehicles Without:	
General Information.....	92	Auto-Dimming Interior Mirror.....	85
Information Messages.....	94	Introduction.....	7
Active Park Assist.....	95	<b>J</b>	
Adaptive Cruise Control.....	95	Jump Starting the Vehicle.....	243
Alarm.....	95	Connecting the Jumper Cables.....	243
Automatic High Beam Control.....	96	Jump Starting.....	244
Auto-Start-Stop.....	96	Preparing Your Vehicle.....	243
Blind Spot Information and Cross Traffic		Removing the Jumper Cables.....	244
Alert Systems.....	97	<b>K</b>	
Brake System.....	97	Keyless Entry.....	67
Doors and Locks.....	98	Disabled Keys.....	68
Driver Alert.....	98	General Information.....	67
Engine.....	98	Locking and Unlocking the Doors with the	
Fuel System.....	99	Key Blade.....	68
Headlamps.....	99	Locking Your Vehicle.....	67
Hill Start Assist.....	99	Passive Key.....	67
Lane Keeping System.....	99	Unlocking Your Vehicle.....	68
Maintenance.....	100	Keys and Remote Controls.....	51
MyKey.....	101	<b>L</b>	
Parking Aid.....	101	Lane Keeping System.....	205
Parking Brake.....	102	Lane Keeping System Display.....	208
Pre-Collision Assist.....	102	Lane Keeping System Messages.....	209
Rear Window Lock.....	102	Lane Keeping System Settings.....	206
Remote Control.....	102	Lane Keeping System Warning Lamps and	
Selective Catalytic Reductant		Indicators.....	208
System.....	103	Switching Lane Keeping System On or	
Stability Control.....	105	Off.....	206
Starting System.....	105	Liftgate.....	69
Steering System.....	105	Lighting Control.....	78
Tire Pressure Monitoring System.....	106	Headlamp Flasher.....	79
Transmission.....	106	High Beams.....	78
Wireless Accessory Charging.....	107	Parking Lamps.....	78
Installing Child Restraints.....	19	Lighting.....	78
Child Restraints.....	19	General Information.....	78
Using Lap and Shoulder Belts.....	20	Load Carriers	
Using Lower Anchors and Tethers for		See: Roof Racks and Load Carriers.....	224
Children (LATCH).....	22	Load Carrying.....	221
Using Tether Straps.....	24	Load Limit.....	225
Instrument Cluster.....	87	Special Loading Instructions for Owners of	
Instrument Lighting Dimmer.....	79	Pick-up Trucks and Utility-type	
Instrument Panel Overview.....	17	Vehicles.....	229
Interior Lamps.....	82		
Courtesy Lamp.....	82		
Reading Lamps.....	82		
Interior Mirror - Vehicles With:			
Auto-Dimming Interior Mirror.....	85		

# Index

Vehicle Loading - with and without a Trailer.....	225
Locking and Unlocking.....	63
Autolock.....	65
Autounlock.....	65
Emergency Locking with the Key.....	65
Locking and Unlocking the Doors From Inside.....	63
Locking and Unlocking the Doors with the Key Blade.....	64
Opening the Double Rear Doors.....	63
Opening the Double Rear Doors From Inside.....	66
Remote Control.....	63
Smart Unlocks for Integrated Keyhead Transmitter.....	64
Unlocking the Doors with the Interior Door Handles.....	64
Luggage Anchor Points.....	221
Lug Nuts	
See: Changing a Road Wheel.....	320
Lug Nuts.....	325
<b>M</b>	
Maintenance.....	261
General Information.....	261
Manual Climate Control.....	108
Directing Air to the Footwell Air Vents.....	109
Directing Air to the Instrument Panel Air Vents.....	109
Directing Air to the Windshield Air Vents.....	109
Setting the Blower Motor Speed.....	108
Setting the Temperature.....	109
Switching Maximum Cooling On and Off.....	108
Switching Maximum Defrost On and Off.....	108
Switching the Air Conditioning On and Off.....	108
Switching the Climate Control On and Off.....	108
Switching the Recirculated Air On and Off.....	108
Manual Liftgate.....	69
Closing the Liftgate.....	69
Opening the Liftgate.....	69
Unlocking the Liftgate.....	69
Manual Seats.....	117
Adjusting the Lumbar Support.....	118
Adjusting the Seat Backrest.....	118
Adjusting the Seat Height.....	118
Moving the Seat Backward and Forward.....	117
Single Passenger Seat.....	118
Message Center	
See: Information Displays.....	92
Mirrors	
See: Windows and Mirrors.....	83
Mobile Communications Equipment.....	15
Motorcraft Parts - 1.5L Duratorq-TDCi Diesel.....	330
Motorcraft Parts - 2.0L Duratec-HE (M14)/2.0L Flex Fuel.....	331
Motorcraft Parts - 2.5L.....	332
MyKey Settings.....	56
Configurable Settings.....	56
Non-Configurable Settings.....	56
MyKey Troubleshooting - Vehicles With:	
Push Button Start.....	61
What is an admin key?.....	61
Why can I not clear the MyKeys?.....	61
Why can I not create a MyKey?.....	61
Why can I not program a MyKey?.....	61
Why can I not start the engine with a MyKey?.....	62
Why does the MyKey distance not accumulate?.....	62
MyKey Troubleshooting - Vehicles Without: Push Button Start.....	61
What is an admin key?.....	61
Why can I not clear the MyKeys?.....	61
Why can I not create a MyKey?.....	61
Why can I not program a MyKey?.....	61
Why does the MyKey distance not accumulate?.....	61
MyKey™.....	56
Principle of Operation.....	56
<b>N</b>	
Navigation.....	381
Changing the Format of the Map.....	382
Live Traffic.....	384

# Index

Michelin Travel Guide.....	385	Pairing Your Cell Phone for the First Time.....	379
Navigation Map Updates.....	385	Text Messaging.....	380
Route Guidance.....	383	Using Your Cell Phone.....	380
Setting a Destination.....	381	Playing Media From a USB Device - Vehicles Without: SYNC 3.....	361
Zoom.....	382	Selecting the USB Device.....	361
Normal Scheduled Maintenance.....	419	Supported Audio File Formats.....	361
Intelligent Oil-Life Monitor™.....	419	Post-Crash Alert System.....	245
Maintenance Intervals.....	420	Power Door Locks See: Locking and Unlocking.....	63
<b>O</b>		Power Seats.....	119
Oil Change Indicator Reset.....	267	Power Windows - Vehicles With: One-Touch Open Driver Window.....	84
Resetting the Oil Life Monitoring System.....	267	One-Touch Open.....	84
Oil Check See: Engine Oil Check.....	266	Power Windows - Vehicles With: Rear Power Windows .....	83
Opening and Closing the Hood.....	261	Bounce-Back.....	83
Closing the Hood.....	262	One-Touch Close.....	83
Opening the Hood.....	261	One-Touch Open.....	83
Ordering Additional Owner's Literature.....	252	Rear Window Lock.....	83
Obtaining a French Owner's Manual.....	252	Pre-Collision Assist.....	215
Overhead Console.....	133	Distance Alert.....	217
Rear Door Storage Compartment.....	133	Distance Indication.....	217
<b>P</b>		Pre-Collision Assist Information Messages.....	219
Parking Aids.....	179	Pre-Collision Assist System Sensors.....	218
Principle of Operation.....	179	Pre-Collision Assist Warning Lamp.....	219
Parking Brake.....	174	Programming a MyKey.....	58
Passive Anti-Theft System.....	70	Protecting the Environment.....	16
Programming a Passive Key.....	71	Puncture See: Changing a Road Wheel.....	320
Programming a Remote Flip Key.....	70	Push Button Ignition Switch.....	135
SecuriLock®.....	70	Failure to Start - Vehicles with Manual Transmission.....	135
Passive Key Backup Position.....	55	Fast Restart.....	136
PATS See: Passive Anti-Theft System.....	70	Key Outside Vehicle Audible Warning.....	137
Perchlorate.....	13	Starting System Information Messages.....	137
Personalized Settings.....	94	Starting The Engine - Vehicles with Automatic Transmission.....	135
Measure Units.....	94	Starting The Engine - Vehicles with Manual Transmission.....	135
Switching Chimes Off.....	94	Stopping the Engine When Your Vehicle is Moving - Vehicles with Automatic Transmission.....	136
Personal Safety System™.....	39		
How Does the Personal Safety System Work?.....	39		
Phone.....	379		
Android Auto.....	381		
Apple CarPlay.....	380		

# Index

Stopping the Engine When Your Vehicle is Moving - Vehicles with Manual Transmission.....	136
Stopping the Engine When Your Vehicle is Stationary - Vehicles with Automatic Transmission.....	136
Stopping the Engine When Your Vehicle is Stationary - Vehicles with Manual Transmission.....	136
Switching the Ignition On to Accessory Mode.....	135
Vehicles with a Diesel Engine.....	135
<b>R</b>	
Rear Parking Aid.....	179
Object Distance Indicator.....	180
Rear Parking Aid Information Messages.....	181
Rear Passenger Climate Controls.....	112
Adjusting the Blower Motor Speed.....	113
Directing Air to the Footwell Air Vents.....	113
Directing Air to the Overhead Air Vents.....	113
Directing Air to the Overhead Air Vents and the Footwell Air Vents.....	113
Switching the Rear Passenger Climate Controls On and Off.....	112
Rear Seats - Long Wheelbase, Vehicles With: 60/40 Split Second Row Seating.....	127
Second Row Seats.....	127
Third Row Seats.....	128
Rear Seats - Long Wheelbase, Vehicles With: Second Row Dual Captain Chairs.....	124
Second Row Seats.....	124
Third Row Seats.....	125
Rear Seats - Short Wheelbase.....	120
Second Row Seats.....	120
Third Row Seats.....	122
Rear Under Floor Storage.....	221
Adjustable Load Floor.....	221
Passenger Compartment Floor.....	221
Rear View Camera.....	192
Switching the Rear View Camera Off.....	194
Switching the Rear View Camera On.....	193
Using the Display.....	193
Vehicles With Parking Aid.....	194
Rear View Camera.....	192
See: Rear View Camera.....	192
Rear Window Wiper and Washers.....	77
Rear Window Washer.....	77
Rear Window Wiper.....	77
Rear Wiper Blades.....	275
See: Changing the Rear Wiper Blades - Vehicles With: Manual Liftgate.....	275
See: Changing the Rear Wiper Blades - Vehicles With: Rear Cargo Doors.....	276
Recommended Towing Weights.....	231
Calculating the Maximum Loaded Trailer Weight.....	232
Reduced Engine Performance.....	238
Refueling.....	154
Refueling System Overview.....	154
Refueling System Warning.....	156
Refueling Your Vehicle.....	155
Remote Control - Vehicles With: Keyless Entry and Push Button Start.....	51
Locating Your Vehicle.....	53
Removable Key Blade.....	51
Replacing the Battery.....	52
Sounding the Panic Alarm.....	53
Remote Control - Vehicles With: Remote Flip Key.....	54
Locating Your Vehicle.....	55
Replacing the Battery.....	54
Sounding the Panic Alarm.....	55
Repairing Minor Paint Damage.....	292
Replacement Parts.....	13
Recommendation.....	13
Collision Repairs.....	14
Scheduled Maintenance and Mechanical Repairs.....	14
Warranty on Replacement Parts.....	14
Replacing a Lost Key or Remote Control.....	55
Reporting Safety Defects (Canada Only).....	252
Reporting Safety Defects (U.S. Only).....	252
Roadside Assistance.....	241
Vehicles Sold in Canada: Getting Roadside Assistance.....	242
Vehicles Sold in Canada: Roadside Assistance Program Coverage.....	242



# Index

Vehicles Sold in Canada: Using Roadside Assistance.....	242
Vehicles Sold in the United States: Getting Roadside Assistance.....	241
Vehicles Sold in the United States: Using Roadside Assistance.....	241
Roadside Emergencies.....	241
Roof Racks and Load Carriers.....	224
Maximum Load Weights.....	224
Running-In	
See: Breaking-In.....	238
Running Out of Fuel.....	153
Adding Fuel From a Portable Fuel Container.....	153
Filling a Portable Fuel Container.....	153
<b>S</b>	
Safety Canopy™.....	46
Safety Precautions.....	148
Satellite Radio.....	359
Satellite Radio Electronic Serial Number (ESN).....	360
Satellite Radio Reception Factors.....	359
SiriusXM Satellite Radio Service.....	359
Troubleshooting.....	360
Scheduled Maintenance Record.....	424
Scheduled Maintenance.....	416
Seatbelt Extension.....	38
Seatbelt Height Adjustment.....	35
Seatbelt Reminder.....	36
Belt-Minder™.....	36
Seatbelts.....	32
Principle of Operation.....	32
Seatbelt Warning Lamp and Indicator	
Chime.....	36
Conditions of operation.....	36
Seats.....	115
Security.....	70
Selective Catalytic Reductant System.....	160
Diesel Exhaust Fluid Guidelines.....	160
Filling the Diesel Exhaust Fluid Tank.....	160
Filling the Diesel Exhaust Fluid Tank Using a Container.....	162
Filling the Diesel Exhaust Fluid Tank Using a Fuel Station Pump.....	161
Selective Catalytic Reductant System Warning Lamp.....	163
Settings.....	386
911 Assist.....	391
Ambient Lighting.....	398
Bluetooth.....	388
Clock.....	387
Display.....	399
General.....	396
Media Player.....	387
Mobile Apps.....	394
Navigation.....	392
Phone.....	388
Radio.....	391
Sound.....	386
Valet Mode.....	400
Vehicle.....	398
Voice Control.....	399
Wi-Fi & Hotspot.....	396
Side Airbags.....	45
Side Sensing System.....	183
Object Distance Indicator.....	184
Sitting in the Correct Position.....	115
Sliding Door.....	66
Snow Chains	
See: Using Snow Chains.....	315
Spare Wheel	
See: Changing a Road Wheel.....	320
Special Notices.....	14
New Vehicle Limited Warranty.....	14
On Board Diagnostics Data Link Connector.....	14
Special Instructions.....	14
Special Operating Conditions Scheduled Maintenance.....	422
Speed Control	
See: Cruise Control.....	195
Speed Limiter.....	202
Principle of Operation.....	202
Using the System.....	202
Stability Control.....	177
Principle of Operation.....	177
Starter Switch	
See: Ignition Switch.....	134
Starting a Diesel Engine.....	142
Engine Warning Lamps.....	143
Failure to Start.....	142
Glow Plug Indicator.....	143

# Index

Guarding Against Exhaust Fumes.....	143
Important Ventilating Information.....	143
Starting System Information	
Messages.....	144
Stopping the Engine When Your Vehicle is Moving.....	143
Stopping the Engine When Your Vehicle is Stationary.....	143
Vehicles with an Ignition Key.....	142
Vehicles with a Push Button Ignition Switch.....	142
Starting a Flex Fuel Engine.....	140
Automatic Shutdown.....	141
Failure to Start.....	141
Flex Fuel Engine Start System.....	140
Guarding Against Exhaust Fumes.....	142
Important Ventilating Information.....	142
Stopping the Engine When Your Vehicle is Moving.....	141
Stopping the Engine When Your Vehicle is Stationary.....	141
Starting a Gasoline Engine.....	137
Automatic Engine Shutdown.....	138
Engine Warning Lamps.....	139
Failure to Start.....	138
Guarding Against Exhaust Fumes.....	139
Important Ventilating Information.....	139
Starting System Information	
Messages.....	140
Stopping the Engine When Your Vehicle is Moving.....	139
Stopping the Engine When Your Vehicle is Stationary.....	139
Vehicles with an Ignition Key.....	138
Vehicles with a Push Button Ignition Switch.....	138
Starting and Stopping the Engine.....	134
General Information.....	134
Steering.....	215
Electric Power Steering.....	215
Steering Wheel.....	74
Storage Compartments.....	133
Streaming Bluetooth Audio - Vehicles Without: SYNC 3.....	361
Selecting a Bluetooth Source.....	361
Sun Shades.....	85
Bounce-Back.....	86
Opening and Closing the Sun Shade.....	86
Sun Shade Relearning.....	86
Supplementary Restraints System.....	40
Principle of Operation.....	40
Switching Off the Engine.....	144
Vehicles With a Turbocharger.....	144
Symbols Glossary.....	7
SYNC™ 3.....	363
General Information.....	363
SYNC™ 3 Troubleshooting.....	400
<b>T</b>	
Technical Specifications	
See: Capacities and Specifications.....	327
The Better Business Bureau (BBB) Auto Line Program (U.S. Only).....	249
Tire Care.....	301
Glossary of Tire Terminology.....	302
Information About Uniform Tire Quality Grading.....	301
Information Contained on the Tire Sidewall.....	303
Temperature A B C.....	302
Traction AA A B C.....	302
Treadwear.....	301
Tire Inflation When Punctured	
See: Tire Sealant and Inflator Kit.....	296
Tire Pressure Monitoring System.....	316
Changing Tires With a Tire Pressure Monitoring System.....	317
Tire Pressure Monitoring System Reset Procedure.....	319
Understanding Your Tire Pressure Monitoring System.....	317
Tire Pressures.....	324
Tire Repair Kit	
See: Tire Sealant and Inflator Kit.....	296
Tire Sealant and Inflator Kit.....	296
After Using the Tire Sealant and Inflator Kit.....	300
Using the Tire Sealant and Inflator Kit.....	297
Tires	
See: Wheels and Tires.....	295
Towing a Trailer.....	230
Load Placement.....	230
Towing Points.....	245
Front Towing Point.....	245

# Index

Rear Towing Point.....	246	USB Port - Vehicles Without: SYNC	
Towing Eye Location.....	246	3.....	362
Towing the Vehicle on Four		Using Adaptive Cruise Control.....	362
Wheels.....	237	Automatic Cancellation.....	199
Emergency Towing.....	237	Blocked Sensor.....	200
Recreational Vehicle Towing.....	237	Canceling the Set Speed.....	199
Towing.....	230	Changing the Set Speed.....	198
Traction Control.....	176	Detection Issues.....	199
Principle of Operation.....	176	Following a Vehicle.....	197
Trailer Sway Control.....	231	Hilly Condition Usage.....	199
Transmission Code Designation -		Overriding the System.....	198
6-Speed Automatic		Resuming the Set Speed.....	199
Transmission.....	334	Setting the Adaptive Cruise Speed.....	197
Transmission Code Designation -		Setting the Gap Distance.....	198
8-Speed Automatic		Switching Adaptive Cruise Control	
Transmission.....	335	Off.....	199
Transmission.....	169	Switching Adaptive Cruise Control	
Transporting the Vehicle.....	236	On.....	196
Trip Computer.....	94	Switching to Normal Cruise Control.....	201
Average Fuel.....	94	System Not Available.....	200
Digital Speedometer.....	94	Using Cruise Control.....	195
Distance to Empty.....	94	Switching Cruise Control Off.....	195
Resetting the Trip Computer.....	94	Switching Cruise Control On.....	195
Trip Odometer.....	94	Using MyKey With Remote Start	
Type Approvals.....	464	Systems.....	61
Radio Frequency Certification Logos for		Using Snow Chains.....	315
Blind Spot Information System.....	471	Vehicles with Stability Control.....	316
Radio Frequency Certification Logos for Mid		Using Stability Control.....	178
Range Radar.....	466	Using Traction Control.....	176
Radio Frequency Certification Logos for		Switching the System Off.....	176
Passive Anti-Theft System.....	467	System Indicator Lights and	
Radio Frequency Certification Logos for		Messages.....	176
Radio Transceiver Module.....	470	Using a Switch.....	176
Radio Frequency Certification Logos for		Using the Information Display	
SYNC 3.....	473	Controls.....	176
Radio Frequency Certification Logos for Tire		Using Voice Recognition.....	362
Pressure Monitoring Sensor(s).....	464	Apps.....	376
Radio Frequency Certification Logos for		Automatic Blower Motor Speed	
Wireless Charging.....	472	Reduction.....	377
<b>U</b>		Entertainment.....	373
Under Hood Overview - 1.5L		General.....	372
Duratorq-TDCi Diesel.....	262	Navigation.....	375
Under Hood Overview - 2.0L Duratec-HE		Phone.....	374
(M14)/2.0L Flex Fuel.....	263	Phone Voice Service.....	362
Under Hood Overview - 2.5L.....	264	Voice Settings.....	377
Unique Driving Characteristics.....	146	Using Winter Tires.....	315
		Utilizing the Mediation/Arbitration	
		Program (Canada Only).....	250

# Index

## V

Vehicle Care.....	286
Vehicle Certification Label.....	334
Vehicle Identification Number.....	333
Vehicle Storage.....	292
Battery.....	293
Body.....	292
Brakes.....	293
Cooling system.....	293
Engine.....	293
Fuel system.....	293
General.....	292
Miscellaneous.....	293
Removing Vehicle From Storage.....	293
Tires.....	293
Ventilation	
See: Climate Control.....	108
VIN	
See: Vehicle Identification Number.....	333

## W

Warning Lamps and Indicators.....	88
Adaptive Cruise Control Indicator.....	88
Airbag Warning Lamp.....	88
Anti-Lock Brake System Warning Lamp.....	88
Blind Spot Information System Indicator.....	88
Brake System Warning Lamp.....	89
Cruise Control Indicator.....	89
Direction Indicator.....	89
Engine Coolant Temperature Warning Lamp.....	89
Engine Warning Lamps.....	89
Fasten Seatbelt Warning Lamp.....	89
Front Fog Lamp Indicator.....	89
Hazard Flashers Warning Lamp.....	90
High Beam Headlamp Indicator.....	90
Ignition Warning Lamp.....	90
Information Message Indicator.....	90
Lamps on Indicator.....	90
Low Fuel Level Warning Lamp.....	90
Low Tire Pressure Warning Lamp.....	90
Oil Pressure Warning Lamp.....	90
Stability Control and Traction Control Indicator.....	90
Stability Control and Traction Control Off Warning Lamp.....	90
Washer Fluid Check.....	273
Washers	
See: Cleaning the Exterior.....	287
Waxing.....	288
Wheel Nuts	
See: Changing a Road Wheel.....	320
Wheels and Tires.....	295
General Information.....	295
Windows and Mirrors.....	83
Windshield Washers.....	76
Windshield Wipers.....	75
Intermittent Wipe.....	75
Speed Dependent Wipers.....	75
Winter Tires	
See: Using Winter Tires.....	315
Wiper Blades	
See: Checking the Wiper Blades.....	275
Wipers and Washers.....	75
Wireless Accessory Charging.....	132
Wrecker Towing	
See: Transporting the Vehicle.....	236

