

# FORD **FOCUS** Owner's Manual





The information contained in this publication was correct at the time of going to print. In the interest of continuous development, we reserve the right to change specifications, design or equipment at any time without notice or obligation. No part of this publication may be reproduced, transmitted, stored in a retrieval system or translated into any language in any form by any means without our written permission. Errors and omissions excepted.

© Ford Motor Company 2020

All rights reserved.

Part Number: CG3784en 202012 20201221153253



# Table of Contents

## Introduction

Acknowledgments .....	15
Symbols Glossary .....	15
REACH .....	16
Replacement Parts Recommendation .....	17
Mobile Communications Equipment .....	17
About This Publication .....	18

## Data Privacy

Data Privacy .....	19
Service Data .....	20
Event Data .....	20
Settings Data .....	21
Connected Vehicle Data - Vehicles With: Modem .....	21
Mobile Device Data - Vehicles With: SYNC 3 .....	21
Emergency Call System Data .....	22

## Environment

Protecting the Environment .....	23
----------------------------------	----

## Visual Search

Steering Wheel - Excluding: ST .....	24
Steering Wheel - ST .....	24
Instrument Panel - LHD .....	25
Instrument Panel - RHD .....	26
Center Console - Automatic Transmission, Vehicles With: Front Parking Aid/Head Up Display (HUD)/ Rear Parking Aid, Vehicles Without: Active Park Assist, Excluding: ST .....	27
Center Console - Automatic Transmission, Vehicles Without: Active Park Assist/Front Parking Aid/Head Up Display (HUD)/Rear Parking Aid, Excluding: ST .....	27

Center Console - Automatic Transmission, Vehicles With: Head Up Display (HUD), Vehicles Without: Active Park Assist/Front Parking Aid/ Rear Parking Aid, Excluding: ST .....	28
Center Console - Automatic Transmission, Vehicles With: Front Parking Aid/Rear Parking Aid, Vehicles Without: Active Park Assist/Head Up Display (HUD), Excluding: ST .....	28
Center Console - Automatic Transmission, Vehicles With: Active Park Assist/Front Parking Aid/Rear Parking Aid, Vehicles Without: Head Up Display (HUD), Excluding: ST .....	29
Center Console - Automatic Transmission, Vehicles With: Active Park Assist/Front Parking Aid/Head Up Display (HUD)/Rear Parking Aid, Excluding: ST .....	29
Center Console - Manual Transmission, LHD, Excluding: ST .....	30
Center Console - Manual Transmission, RHD, Excluding: ST .....	30
Center Console - ST, Automatic Transmission, Vehicles With: Active Park Assist/Front Parking Aid/Rear Parking Aid, Vehicles Without: Head Up Display (HUD) .....	31
Center Console - ST, Automatic Transmission, Vehicles With: Front Parking Aid/Head Up Display (HUD)/ Rear Parking Aid, Vehicles Without: Active Park Assist .....	31
Center Console - ST, Automatic Transmission, Vehicles Without: Active Park Assist/Front Parking Aid/Head Up Display (HUD)/Rear Parking Aid .....	32
Center Console - ST, Automatic Transmission, Vehicles With: Head Up Display (HUD), Vehicles Without: Active Park Assist/Front Parking Aid/ Rear Parking Aid .....	32
Center Console - ST, Automatic Transmission, Vehicles With: Front Parking Aid/Rear Parking Aid, Vehicles Without: Active Park Assist/Head Up Display (HUD) .....	33

# Table of Contents

Center Console - ST, Automatic Transmission, Vehicles With: Active Park Assist/Front Parking Aid/Head Up Display (HUD)/Rear Parking Aid .....	33
Center Console - ST, Manual Transmission, LHD .....	34
Center Console - ST, Manual Transmission, RHD .....	34
<b>Child Safety</b>	
Installing Child Restraints - 4-Door .....	35
Installing Child Restraints - 5-Door/Wagon .....	39
Child Restraint Positioning .....	43
Child Safety Locks - Vehicles With: Mechanical Child Proof Locks .....	47
Child Safety Locks - Vehicles With: Remote Child Proof Locks .....	47
<b>Seatbelts</b>	
Fastening the Seatbelts .....	48
Seatbelt Height Adjustment .....	48
Seatbelt Reminder - Vehicles With: 4.2 Inch Instrument Cluster Display Screen .....	49
Seatbelt Reminder - Vehicles With: 12.3 Inch Instrument Cluster Display Screen .....	50
<b>Supplementary Restraints System</b>	
Principle of Operation .....	52
Driver Airbag .....	52
Passenger Airbag .....	53
Switching the Passenger Airbag On and Off - Vehicles With: 4.2 Inch Instrument Cluster Display Screen .....	53
Switching the Passenger Airbag On and Off - Vehicles With: 12.3 Inch Instrument Cluster Display Screen .....	54
Side Airbags .....	55
Side Curtain Airbags .....	56
<b>Automatic Crash Notification System</b>	
Emergency Assistance .....	57
<b>eCall</b>	
What Is eCall .....	60
How Does eCall Work .....	60
Emergency Call Requirements .....	60
Emergency Call Limitations .....	60
Manually Making an Emergency Call .....	60
Emergency Call Indicators .....	61
Changing the Backup Battery .....	62
eCall - Troubleshooting .....	62
<b>Keys and Remote Controls</b>	
Remote Control Limitations .....	63
Opening and Closing the Flip Key .....	63
Removing the Key Blade .....	63
Locating Your Vehicle .....	64
Changing the Remote Control Battery - Vehicles With: Keyless Entry .....	64
Changing the Remote Control Battery - Vehicles With: Remote Flip Key .....	65
Replacing a Lost Key or Remote Control .....	66
Keys and Remote Controls - Troubleshooting .....	66
Passive Key Backup Position .....	67
<b>MyKey™</b>	
What Is MyKey .....	68
MyKey Settings .....	68
Creating a MyKey - Vehicles With: 4.2 Inch Instrument Cluster Display Screen, Vehicles Without: Push Button Start .....	69

# Table of Contents

Creating a MyKey - Vehicles With: 12.3 Inch Instrument Cluster Display Screen, Vehicles Without: Push Button Start .....	69
Creating a MyKey - Vehicles With: 4.2 Inch Instrument Cluster Display Screen/Keyless Entry/Push Button Start .....	70
Creating a MyKey - Vehicles With: 12.3 Inch Instrument Cluster Display Screen/Keyless Entry/Push Button Start .....	70
Programming a MyKey - Vehicles With: 4.2 Inch Instrument Cluster Display Screen .....	71
Programming a MyKey - Vehicles With: 12.3 Inch Instrument Cluster Display Screen .....	71
Clearing All MyKeys - Vehicles With: 4.2 Inch Instrument Cluster Display Screen .....	71
Clearing All MyKeys - Vehicles With: 12.3 Inch Instrument Cluster Display Screen .....	71
Checking MyKey System Status - Vehicles With: 4.2 Inch Instrument Cluster Display Screen .....	72
Checking MyKey System Status - Vehicles With: 12.3 Inch Instrument Cluster Display Screen .....	72
Using MyKey With Remote Start Systems .....	72
MyKey – Troubleshooting .....	72
<b>Doors and Locks</b>	
Operating the Doors From Outside Your Vehicle .....	76
Operating the Doors From Inside Your Vehicle .....	78
Reprogramming the Unlocking Function - Vehicles With: 4.2 Inch Instrument Cluster Display Screen .....	78
Reprogramming the Unlocking Function - Vehicles With: 12.3 Inch Instrument Cluster Display Screen .....	79
Door Lock Switch Inhibitor .....	79
Autounlock .....	80
Mislock .....	80
Autorelock .....	81
Door Lock Indicators .....	81
Doors and Locks Audible Warnings .....	81
Doors and Locks – Troubleshooting .....	81
<b>Keyless Entry</b>	
Keyless Entry Limitations .....	83
Keyless Entry Settings .....	83
Locking and Unlocking the Doors Using Keyless Entry .....	84
Locking and Unlocking the Liftgate Using Keyless Entry .....	85
Keyless Entry – Troubleshooting .....	85
<b>Liftgate</b>	
Manual Liftgate .....	86
Power Liftgate .....	87
Hands-Free Power Liftgate .....	90
<b>Security</b>	
Passive Anti-Theft System .....	92
Anti-Theft Alarm System .....	92
Anti-Theft Alarm System Settings .....	93
Security – Troubleshooting .....	94
<b>Door Edge Protection</b>	
Principle of Operation .....	96
<b>Steering Wheel</b>	
Adjusting the Steering Wheel .....	97
Locking the Steering Wheel - Vehicles Without: Push Button Start .....	97
Locking the Steering Wheel - Vehicles With: Keyless Entry/Push Button Start .....	98
Heated Steering Wheel .....	98

# Table of Contents

## Wipers and Washers

Windshield Wipers .....	99
Autowipers - Vehicles With: 4.2 Inch Instrument Cluster Display Screen .....	99
Autowipers - Vehicles With: 12.3 Inch Instrument Cluster Display Screen .....	101
Windshield Washers - Vehicles With: 4.2 Inch Instrument Cluster Display Screen .....	102
Windshield Washers - Vehicles With: 12.3 Inch Instrument Cluster Display Screen .....	103
Rear Window Wiper and Washers - Vehicles With: 4.2 Inch Instrument Cluster Display Screen .....	103
Rear Window Wiper and Washers - Vehicles With: 12.3 Inch Instrument Cluster Display Screen .....	104
Headlamp Washers .....	105

## Lighting

General Information .....	106
Lighting Control .....	106
Autolamps - Vehicles With: 4.2 Inch Instrument Cluster Display Screen .....	108
Autolamps - Vehicles With: 12.3 Inch Instrument Cluster Display Screen .....	108
Instrument Lighting Dimmer .....	109
Headlamp Exit Delay .....	109
Automatic High Beam Control - Vehicles With: 4.2 Inch Instrument Cluster Display Screen .....	109
Automatic High Beam Control - Vehicles With: 12.3 Inch Instrument Cluster Display Screen .....	111
Glare-Free High Beam - Vehicles With: 4.2 Inch Instrument Cluster Display Screen .....	112
Glare-Free High Beam - Vehicles With: 12.3 Inch Instrument Cluster Display Screen .....	115

Front Fog Lamps .....	117
Rear Fog Lamps .....	117
Headlamp Leveling .....	117
Adaptive Headlamps - Vehicles With: 4.2 Inch Instrument Cluster Display Screen .....	118
Adaptive Headlamps - Vehicles With: 12.3 Inch Instrument Cluster Display Screen .....	120
Cornering Lamps .....	122
Direction Indicators .....	122
Interior Lamps - Vehicles Without: Map Reading Lamps .....	123
Interior Lamps - Vehicles With: Map Reading Lamps .....	124
Ambient Lighting .....	124

## Windows

Opening and Closing the Windows .....	125
Global Opening and Closing .....	125
Window Bounce-Back .....	126
Locking the Rear Window Controls .....	127

## Interior Mirror

Adjusting the Interior Mirror .....	128
Auto-Dimming Interior Mirror .....	128

## Exterior Mirrors

Adjusting the Exterior Mirrors .....	129
Folding the Exterior Mirrors - Vehicles With: 4.2 Inch Instrument Cluster Display Screen/Power Fold Exterior Mirrors .....	129
Folding the Exterior Mirrors - Vehicles With: 12.3 Inch Instrument Cluster Display Screen/Power Fold Exterior Mirrors .....	129
Folding the Exterior Mirrors - Vehicles With: Manual Fold Exterior Mirrors .....	130



# Table of Contents

## **Moonroof**

Opening and Closing the Sun Shade .....	131
Opening and Closing the Moonroof .....	131
Venting the Moonroof .....	132
Moonroof Bounce-Back .....	132

## **Instrument Cluster - Vehicles With: 4.2 Inch Instrument Cluster Display Screen**

Gauges - Excluding: Mild Hybrid Electric Vehicle (MHEV)/ST .....	133
Gauges - Mild Hybrid Electric Vehicle (MHEV) .....	135

## **Instrument Cluster - Vehicles With: 12.3 Inch Instrument Cluster Display Screen**

Gauges - Excluding: Mild Hybrid Electric Vehicle (MHEV)/ST .....	138
Gauges - Mild Hybrid Electric Vehicle (MHEV) .....	140
Gauges - ST .....	142

## **Information Displays - Vehicles With: 4.2 Inch Instrument Cluster Display Screen**

General Information .....	145
Trip Computer .....	147
Personalized Settings .....	148
Head Up Display .....	150

## **Information Displays - Vehicles With: 12.3 Inch Instrument Cluster Display Screen**

General Information .....	153
Trip Computer .....	154
Personalized Settings .....	154
Head Up Display .....	155

## **Remote Start - Automatic Transmission**

What Is Remote Start .....	158
Remote Start Limitations .....	158
Enabling Remote Start - Vehicles With: 4.2 Inch Instrument Cluster Display Screen .....	158
Enabling Remote Start - Vehicles With: 12.3 Inch Instrument Cluster Display Screen .....	158
Remotely Starting and Stopping the Vehicle .....	158
Remote Start Settings - Vehicles With: 4.2 Inch Instrument Cluster Display Screen, Vehicles Without: Heated Steering Wheel .....	159
Remote Start Settings - Vehicles With: 12.3 Inch Instrument Cluster Display Screen, Vehicles Without: Heated Steering Wheel .....	159
Remote Start Settings - Vehicles With: 4.2 Inch Instrument Cluster Display Screen/Heated Steering Wheel .....	160
Remote Start Settings - Vehicles With: 12.3 Inch Instrument Cluster Display Screen/Heated Steering Wheel .....	161

## **Climate Control**

Manual Climate Control .....	162
Automatic Climate Control .....	163
Hints on Controlling the Interior Climate - Vehicles With: Automatic Temperature Control .....	165
Hints on Controlling the Interior Climate - Vehicles With: Manual Temperature Control .....	166
Heated Windshield .....	166
Heated Rear Window - Vehicles With: Automatic Temperature Control .....	167
Heated Rear Window - Vehicles With: Manual Temperature Control .....	167
Heated Exterior Mirrors .....	167
Auxiliary Heater - Vehicles With: 4.2 Inch Instrument Cluster Display Screen .....	167

# Table of Contents

Auxiliary Heater - Vehicles With: 12.3 Inch Instrument Cluster Display Screen .....	172
---	-----

## Seats

Sitting in the Correct Position .....	177
Head Restraints .....	177
Manual Seats - Vehicles With: 2-Way Manual Seat .....	178
Manual Seats - Vehicles With: 4-Way Manual Seat .....	179
Manual Seats - Vehicles With: 6-Way Manual Seat .....	180
Power Seats .....	182
Rear Seats - Wagon .....	183
Rear Seats - 4-Door/5-Door .....	184
Heated Seats .....	185

## Rear Occupant Alert System

What is the Rear Occupant Alert System .....	186
How Does the Rear Occupant Alert System Work .....	186
Rear Occupant Alert System Precautions .....	186
Rear Occupant Alert System Limitations .....	186
Switching Rear Occupant Alert System On and Off .....	186
Rear Occupant Alert System Indicators .....	187
Rear Occupant Alert System Audible Warnings .....	187

## Auxiliary Power Points

Auxiliary Power Points .....	188
Cigar Lighter .....	188

## Wireless Accessory Charger

Locating the Wireless Accessory Charger .....	189
Charging a Wireless Device .....	189

Wireless Accessory Charger Indicators .....	189
Wireless Accessory Charger – Troubleshooting .....	190

## Storage Compartments

Cup Holders .....	191
-------------------	-----

## Starting and Stopping the Engine

Starting and Stopping the Engine – Precautions .....	192
Ignition Switch .....	192
Push Button Ignition Switch .....	193
Starting the Engine .....	193
Stopping the Engine .....	196
Automatic Engine Stop - Vehicles With: Push Button Start .....	199
Starting and Stopping the Engine – Troubleshooting .....	200

## Unique Driving Characteristics

Hybrid Vehicle Operation .....	204
--------------------------------	-----

## Auto-Start-Stop - Automatic Transmission

What Is Auto-Start-Stop .....	205
Auto-Start-Stop Precautions .....	205
Switching Auto-Start-Stop On and Off .....	205
Stopping the Engine .....	205
Restarting the Engine .....	205
Auto-Start-Stop Indicators .....	206
Auto-Start-Stop – Troubleshooting .....	206

## Auto-Start-Stop - Manual Transmission, Excluding: Mild Hybrid Electric Vehicle (MHEV)

What Is Auto-Start-Stop .....	208
-------------------------------	-----

# Table of Contents

Auto-Start-Stop Precautions .....	208
Switching Auto-Start-Stop On and Off .....	208
Stopping the Engine .....	208
Restarting the Engine .....	208
Auto-Start-Stop Indicators .....	209
Auto-Start-Stop Audible Warning .....	209
Auto-Start-Stop – Troubleshooting .....	209

## Auto-Start-Stop - Mild Hybrid Electric Vehicle (MHEV)

What Is Auto-Start-Stop .....	211
Auto-Start-Stop Precautions .....	211
Auto-Start-Stop Settings .....	211
Switching Auto-Start-Stop On and Off .....	211
Stopping the Engine .....	211
Restarting the Engine .....	212
Auto-Start-Stop Indicators .....	212
Auto-Start-Stop Audible Warning .....	212
Auto-Start-Stop – Troubleshooting .....	213

## Fuel and Refueling

Safety Precautions .....	215
Fuel Quality - Gasoline .....	215
Fuel Quality - Diesel .....	216
Fuel Quality - E85 .....	216
Fuel Filler Funnel Location .....	217
Running Out of Fuel .....	217
Refueling .....	219
Fuel Consumption .....	221

## Engine Emission Control

Catalytic Converter - 1.0L EcoBoost™/ 1.5L EcoBoost™/1.5L TiVCT/2.3L EcoBoost™ .....	223
Gasoline Particulate Filter .....	223
Diesel Particulate Filter .....	225

## Selective Catalytic Reduction System

What Is the Selective Catalytic Reduction System .....	228
Selective Catalytic Reduction System Precautions .....	228
Selective Catalytic Reduction System Requirements .....	228
Selective Catalytic Reduction System Guidelines .....	228
Filling the Selective Catalytic Reduction System Tank .....	229
Checking the Selective Catalytic Reduction Fluid Level - Vehicles With: 4.2 Inch Instrument Cluster Display Screen .....	231
Checking the Selective Catalytic Reduction Fluid Level - Vehicles With: 12.3 Inch Instrument Cluster Display Screen .....	231
Selective Catalytic Reduction Fluid Consumption .....	231
AdBlue® Capacity and Specification .....	231
Selective Catalytic Reduction System – Troubleshooting .....	232

## Manual Transmission

Manual Transmission Precautions .....	235
Shifting Into Reverse .....	235
Manual Transmission Shift Indicators .....	235
Checking the Clutch Fluid Level .....	235
Clutch Fluid Specification .....	235
Manual Transmission – Troubleshooting .....	236

## Automatic Transmission

Automatic Transmission Precautions .....	237
Automatic Transmission Positions .....	237
Automatic Transmission Position Indicators - Vehicles Without: Paddle Shifters .....	237

# Table of Contents

---

Automatic Transmission Position Indicators - Vehicles With: Paddle Shifters .....	238
Automatic Transmission Shift Indicators - Vehicles With: Paddle Shifters .....	238
Manually Shifting Gears - Vehicles With: Paddle Shifters .....	238
Stay in Neutral Mode - 8-Speed Automatic Transmission .....	239
Automatic Return to Park (P) - 8-Speed Automatic Transmission .....	240
Brake Shift Interlock - 6-Speed Automatic Transmission .....	240
Automatic Transmission Audible Warnings .....	241
Automatic Transmission – Troubleshooting .....	242

## Electronic Limited-Slip Differential

Electronic Limited-Slip Differential – Troubleshooting .....	243
--	-----

## Brakes

General Information .....	244
Hints on Driving With Anti-Lock Brakes .....	245
Electric Parking Brake - Manual Transmission .....	245
Electric Parking Brake - Automatic Transmission .....	247
Hill Start Assist - Vehicles With: 4.2 Inch Instrument Cluster Display Screen .....	250
Hill Start Assist - Vehicles With: 12.3 Inch Instrument Cluster Display Screen .....	251
Auto Hold .....	252

## Traction Control

Principle of Operation .....	254
Using Traction Control .....	254

## Stability Control

Principle of Operation .....	255
Using Stability Control - Excluding: ST .....	255
Using Stability Control - ST .....	255

## Parking Aids

Parking Aid Precautions .....	257
Switching Parking Aid On and Off .....	257
Rear Parking Aid .....	258
Front Parking Aid .....	258
Side Parking Aid .....	259
Parking Aid Indicators .....	261
Parking Aids – Troubleshooting .....	261

## Rear View Camera

What Is the Rear View Camera .....	263
Rear View Camera Precautions .....	263
Rear View Camera Limitations .....	263
Locating the Rear View Camera .....	263
Rear View Camera Guide Lines .....	263
Rear View Camera Settings .....	264

## 180 Degree Camera

What Is the 180 Degree Camera .....	266
How Does the 180 Degree Camera Work .....	266
180 Degree Camera Precautions .....	266
Switching the 180 Degree Camera On and Off .....	266

## Active Park Assist

What Is Active Park Assist .....	267
Active Park Assist Precautions .....	267
Switching Active Park Assist On and Off .....	267
Entering a Parallel Parking Space - 6-Speed Automatic Transmission/ 6-Speed Manual Transmission .....	267

# Table of Contents

Entering a Parallel Parking Space - 8-Speed Automatic Transmission .....	268	Blind Spot Information System .....	327
Entering a Perpendicular Parking Space - 6-Speed Automatic Transmission/ 6-Speed Manual Transmission .....	268	Cross Traffic Alert .....	329
Entering a Perpendicular Parking Space - 8-Speed Automatic Transmission .....	269	Traffic Sign Recognition .....	332
Exiting a Parking Space - 6-Speed Automatic Transmission/6-Speed Manual Transmission .....	269	Speed Sign Recognition .....	334
Exiting a Parking Space - 8-Speed Automatic Transmission .....	270	Wrong Way Alert .....	335
Active Park Assist – Troubleshooting .....	270	Eco .....	337
		Steering .....	337
		Pre-Collision Assist .....	338
<b>Cruise Control</b>		<b>Driving Aids - Vehicles With: 12.3 Inch Instrument Cluster Display Screen</b>	
Principle of Operation .....	272	Intelligent Speed Limiter - Vehicles Without: Lane Centering .....	343
Using Cruise Control .....	272	Intelligent Speed Limiter - Vehicles With: Lane Centering .....	344
Using Adaptive Cruise Control - Vehicles With: 4.2 Inch Instrument Cluster Display Screen/Adaptive Cruise Control .....	273	Driver Alert .....	346
Using Adaptive Cruise Control - Vehicles With: 4.2 Inch Instrument Cluster Display Screen/Adaptive Cruise Control With Lane Centering .....	282	Lane Keeping System .....	348
Using Adaptive Cruise Control - Vehicles With: 12.3 Inch Instrument Cluster Display Screen/Adaptive Cruise Control .....	294	Blind Spot Information System .....	351
Using Adaptive Cruise Control - Vehicles With: 12.3 Inch Instrument Cluster Display Screen/Adaptive Cruise Control With Lane Centering .....	304	Cross Traffic Alert .....	353
		Traffic Sign Recognition .....	356
		Speed Sign Recognition .....	357
		Wrong Way Alert .....	358
		Eco .....	359
		Pre-Collision Assist .....	360
<b>Driving Aids - Vehicles With: 4.2 Inch Instrument Cluster Display Screen</b>		<b>Drive Mode Control</b>	
Intelligent Speed Limiter - Vehicles Without: Lane Centering .....	317	What Is Drive Mode Control .....	365
Intelligent Speed Limiter - Vehicles With: Lane Centering .....	319	Selecting a Drive Mode - Excluding: ST .....	365
Driver Alert .....	322	Selecting a Drive Mode - ST .....	365
Lane Keeping System .....	323	Drive Modes .....	365
		Drive Mode Control – Troubleshooting .....	366
		<b>Efficient Drive Mode</b>	
		What Is Efficient Drive Mode .....	367
		Switching Efficient Drive Mode On and Off - Vehicles With: 4.2 Inch Instrument Cluster Display Screen .....	367

# Table of Contents

Switching Efficient Drive Mode On and Off - Vehicles With: 12.3 Inch Instrument Cluster Display Screen .....	367
--	-----

Displaying the Efficient Drive Mode - Vehicles With: 4.2 Inch Instrument Cluster Display Screen .....	367
---	-----

Trip Summary .....	367
--------------------	-----

Efficient Drive Mode Indicators .....	368
---------------------------------------	-----

## Local Hazard Information

What Is Local Hazard Information .....	369
--	-----

Local Hazard Information Precautions .....	369
--	-----

Enabling Local Hazard Information .....	369
---	-----

Checking Local Hazard Information Status - Vehicles With: 4.2 Inch Instrument Cluster Display Screen .....	369
--	-----

Checking Local Hazard Information Status - Vehicles With: 12.3 Inch Instrument Cluster Display Screen .....	369
---	-----

## Load Carrying

General Information .....	370
---------------------------	-----

Luggage Anchor Points .....	370
-----------------------------	-----

Rear Loadspace Hatches .....	370
------------------------------	-----

Rear Under Floor Storage - Wagon .....	371
--	-----

Cargo Nets - Wagon .....	372
--------------------------	-----

Luggage Covers - Wagon .....	373
------------------------------	-----

Luggage Covers - 5-Door .....	374
-------------------------------	-----

Roof Racks and Load Carriers - 4-Door, Vehicles With: Panoramic Roof Opening Panel .....	374
--	-----

Roof Racks and Load Carriers - 5-Door, Vehicles With: Panoramic Roof Opening Panel .....	374
--	-----

Roof Racks and Load Carriers - Wagon, Vehicles With: Panoramic Roof Opening Panel .....	375
---	-----

Roof Racks and Load Carriers - Vehicles Without: Panoramic Roof Opening Panel .....	376
---	-----

## Luggage Compartment

Luggage Compartment Hook .....	377
--------------------------------	-----

## Towing

Towing a Trailer - 4-Door .....	378
---------------------------------	-----

Towing a Trailer - 5-Door/Wagon .....	378
---------------------------------------	-----

Trailer Sway Control .....	379
----------------------------	-----

Tow Ball - Vehicles With: Detachable Tow Ball .....	379
---	-----

Tow Ball - Vehicles With: Retractable Tow Ball .....	383
--	-----

Towing the Vehicle on Four Wheels - 6-Speed Automatic Transmission .....	385
--	-----

Towing the Vehicle on Four Wheels - Manual Transmission .....	387
---	-----

Towing the Vehicle on Four Wheels - 7-Speed Automatic Transmission/ 8-Speed Automatic Transmission .....	387
--	-----

## Driving Hints

Cold Weather Precautions .....	388
--------------------------------	-----

Breaking-In .....	388
-------------------	-----

Driving Economically .....	388
----------------------------	-----

Driving Through Shallow Water .....	388
-------------------------------------	-----

Floor Mats .....	389
------------------	-----

## Roadside Emergencies

Hazard Flashers .....	390
-----------------------	-----

First Aid Kit .....	390
---------------------	-----

Warning Triangle .....	390
------------------------	-----

Jump Starting the Vehicle .....	390
---------------------------------	-----

Towing Points .....	392
---------------------	-----

## Crash and Breakdown Information

Post-Crash Alert System .....	394
-------------------------------	-----

Post Impact Braking .....	394
---------------------------	-----

Automatic Crash Shutoff .....	394
-------------------------------	-----

# Table of Contents

## Fuses

Fuse Box Locations .....	396
Fuse Specification Chart .....	397
Changing a Fuse .....	402

## Maintenance

General Information .....	404
Opening and Closing the Hood - LHD .....	404
Opening and Closing the Hood - RHD .....	406
Under Hood Overview - 1.0L EcoBoost™, LHD .....	408
Under Hood Overview - 1.0L EcoBoost™, RHD .....	409
Under Hood Overview - 1.5L TiVCT, LHD .....	410
Under Hood Overview - 1.5L TiVCT, RHD .....	411
Under Hood Overview - 1.5L EcoBlue, LHD .....	412
Under Hood Overview - 1.5L EcoBlue, RHD .....	413
Under Hood Overview - 1.5L EcoBoost™, LHD .....	414
Under Hood Overview - 1.5L EcoBoost™, RHD .....	415
Under Hood Overview - 2.0L EcoBlue, LHD .....	416
Under Hood Overview - 2.0L EcoBlue, RHD .....	417
Under Hood Overview - 2.3L EcoBoost™, LHD .....	418
Under Hood Overview - 2.3L EcoBoost™, RHD .....	419
Engine Oil Dipstick - 1.0L EcoBoost™/ 1.5L TiVCT .....	420
Engine Oil Dipstick - 1.5L EcoBlue .....	420
Engine Oil Dipstick - 1.5L EcoBoost™ .....	420
Engine Oil Dipstick - 2.0L EcoBlue .....	420
Engine Oil Dipstick - 2.3L EcoBoost™ .....	421

Engine Oil Check .....	421
Oil Change Indicator Reset - Vehicles With: 4.2 Inch Instrument Cluster Display Screen .....	422
Oil Change Indicator Reset - Vehicles With: 12.3 Inch Instrument Cluster Display Screen .....	423
Engine Cooling Fan - Gasoline .....	423
Engine Cooling Fan - Diesel .....	423
Engine Coolant Check .....	423
Brake Fluid Check .....	427
Clutch Fluid Check - Manual Transmission .....	428
Changing the 12V Battery .....	428
Washer Fluid Check .....	430
Checking the Wiper Blades .....	430
Changing the Front Wiper Blades .....	430
Changing the Rear Wiper Blades .....	430
Removing a Headlamp .....	431
Removing a Rear Lamp - 5-Door/Wagon .....	432
Removing a Rear Lamp - 4-Door .....	433
Changing a Bulb .....	434

## Track Use - ST

Track Use Precautions .....	438
-----------------------------	-----

## Launch Control - ST, Manual Transmission

What Is Launch Control .....	439
Launch Control Precautions .....	439
Launch Control Limitations .....	439
Switching Launch Control On and Off .....	439
Using Launch Control .....	439
Launch Control Indicators .....	439

## Vehicle Care

Cleaning the Exterior .....	440
Cleaning the Interior .....	441
Repairing Minor Paint Damage .....	443

# Table of Contents

Waxing Your Vehicle .....	443
---------------------------	-----

## Wheels and Tires

General Information .....	444
Tire Sealant and Inflator Kit .....	444
Tire Care .....	448
Using Summer Tires .....	449
Using Winter Tires .....	449
Using Snow Chains - Excluding: Active/ ST .....	449
Using Snow Chains - Active .....	450
Using Snow Chains - ST .....	451
Changing a Road Wheel .....	451
Tire Pressures - Excluding: Active/ST .....	457
Tire Pressures - Active .....	459
Tire Pressures - ST .....	460
Lug Nuts .....	462

## Tire Pressure Monitoring System

What Is the Tire Pressure Monitoring System .....	463
Tire Pressure Monitoring System Precautions .....	463
Tire Pressure Monitoring System Limitations .....	463
Viewing the Tire Pressures - Vehicles With: 4.2 Inch Instrument Cluster Display Screen .....	463
Viewing the Tire Pressures - Vehicles With: 12.3 Inch Instrument Cluster Display Screen .....	464
Resetting Tire Pressure Monitoring System - Vehicles With: 4.2 Inch Instrument Cluster Display Screen .....	464
Resetting Tire Pressure Monitoring System - Vehicles With: 12.3 Inch Instrument Cluster Display Screen .....	464
Tire Pressure Monitoring System – Troubleshooting .....	465

## Capacities and Specifications

Vehicle Dimensions .....	467
Vehicle Dimensions - 5-Door/Active .....	468
Vehicle Dimensions - 5-Door, Excluding: Active .....	469
Vehicle Dimensions - Excluding: Active .....	470
Vehicle Dimensions - 4-Door .....	471
Towbar Dimensions - 5-Door .....	472
Towbar Dimensions - Wagon .....	474
Vehicle Identification Plate .....	475
Vehicle Identification Number .....	476
Capacities and Specifications - 1.0L EcoBoost™ .....	476
Capacities and Specifications - 1.5L TiVCT .....	478
Capacities and Specifications - 1.5L EcoBlue .....	480
Capacities and Specifications - 1.5L EcoBoost™ .....	483
Capacities and Specifications - 2.0L EcoBlue .....	485
Capacities and Specifications - 2.3L EcoBoost™ .....	487
Bulb Specification Chart .....	489
Fuel Consumption Figures .....	491
Fuel Consumption Figures - 1.0L EcoBoost™ .....	491
Fuel Consumption Figures - 1.5L TiVCT .....	492
Fuel Consumption Figures - 1.5L EcoBlue .....	493
Fuel Consumption Figures - 1.5L EcoBoost™ .....	494
Fuel Consumption Figures - 2.0L EcoBlue .....	495
Fuel Consumption Figures - 2.3L EcoBoost™ .....	496

## Connected Vehicle

What Is a Connected Vehicle .....	497
-----------------------------------	-----



# Table of Contents

---

Connected Vehicle Requirements .....	497	Playing Media From a USB Device - Vehicles Without: SYNC .....	511
Connected Vehicle Limitations .....	497	Playing Media From a USB Device - Vehicles With: SYNC 2.5 .....	512
Connecting the Vehicle to a Mobile Network .....	497	USB Port .....	512
Connecting the Vehicle to a Wi-Fi Network .....	497	Apps - Vehicles With: SYNC 2.5 .....	512
Connected Vehicle – Troubleshooting - Vehicles With: Modem .....	498	Using Voice Recognition .....	515
Connected Vehicle – Troubleshooting - Vehicles With: SYNC 3/SYNC 2.5 .....	499	Audio System – Troubleshooting - Vehicles With: SYNC 2.5 .....	516

## Vehicle Wi-Fi Hotspot

Creating a Vehicle Wi-Fi Hotspot .....	501
Changing the Vehicle Wi-Fi Hotspot Name or Password .....	501

## Audio System

General Information .....	502
Audio Unit - Vehicles Without: SYNC .....	502
Audio Unit - Vehicles With: SYNC 3 .....	504
Audio Unit - Vehicles With: SYNC 2.5 .....	505
AM/FM Radio - Vehicles Without: SYNC .....	507
AM/FM Radio - Vehicles With: SYNC 2.5 .....	507
Digital Radio - Vehicles Without: SYNC .....	508
Digital Radio - Vehicles With: SYNC 2.5 .....	509
Audio Unit Clock and Date Displays - Vehicles Without: SYNC .....	510
Audio Unit Clock and Date Displays - Vehicles With: SYNC 2.5 .....	510
Connecting a Bluetooth® Device - Vehicles Without: SYNC .....	510
Connecting a Bluetooth® Device - Vehicles With: SYNC 2.5 .....	510
Streaming Bluetooth Audio - Vehicles Without: SYNC .....	510
Streaming Bluetooth Audio - Vehicles With: SYNC 2.5 .....	511

## SYNC™ 3

General Information .....	518
Using Voice Recognition .....	520
Entertainment .....	526
Climate .....	528
Phone .....	531
Navigation .....	533
Apps .....	537
Settings .....	538
SYNC™ 3 Troubleshooting .....	540

## Appendices

Electromagnetic Compatibility .....	550
eCall User Information .....	553
End User License Agreement .....	556
Declaration of Conformity .....	580



# Introduction

## ACKNOWLEDGMENTS

Your vehicle could have components that use open source software. For additional information, visit <http://corporate.ford.com/ford-open-source.html>.

## SYMBOLS GLOSSARY

These are some of the symbols you may see on your vehicle.



Safety alert.



See the Owner's Manual.



Air conditioning system.



Anti-lock braking system.



Avoid smoking, flames or sparks.



Battery.



Battery acid.



Brake fluid level.



Brake system.



Brake failure.



Cabin air filter.



Check fuel cap.



Child safety door lock.



Child safety door unlock.



Child seat lower anchor.



Child seat tether anchor.



Cruise control.



Do not open when hot.



Electronic power steering malfunction.



Engine air filter.



Engine coolant.



Engine coolant temperature.



Engine oil.



Explosive gas.



Fan warning.



Fasten seatbelt.

# Introduction



Front airbag.



Front fog lamps.



Fuel pump reset.



Fuse compartment.



Hazard warning flashers.



Heated rear window.



Heated windshield.



Interior luggage compartment release.



Jack.



Keep out of reach of children.



Lighting control.



Low tire pressure warning.



Maintain correct fluid level.



Panic alarm.



Parking aid.



Parking brake.



Power steering fluid.



Power windows.



Power window lockout.



Malfunction indicator lamp (MIL).



Service engine soon.



Side airbag.



Shield the eyes.



Stability control.



Windshield wash and wipe.

## REACH

We are committed to promoting the responsible manufacturing, handling and use of our products and support the underlying goals of **REACH**, a European Union regulation that concerns the registration, evaluation, authorisation and restriction of chemicals.

We specifically support Regulation EC 1907/2006 Article 33(1) that relates to substances of very high concern which appear on the current list for authorisation.

# Introduction

---

If these substances do exist in a product, it is important to guarantee their safe use so the regulation is designed to enable you to take any appropriate risk management measures.

To find out more about the **REACH** directive, search **REACH** on the local Ford website.

**Note:** To find the local Ford website, visit <https://corporate.ford.com/operations/locations/global-links.html>.

## REPLACEMENT PARTS RECOMMENDATION

We have built your vehicle to the highest standards using quality parts. We recommend that you demand the use of genuine Ford and Motorcraft parts whenever your vehicle requires scheduled maintenance or repair. You can clearly identify genuine Ford and Motorcraft parts by looking for the Ford, FoMoCo or Motorcraft branding on the parts or their packaging.

### Scheduled Maintenance and Mechanical Repairs

One of the best ways for you to make sure that your vehicle provides years of service is to have it maintained in line with our recommendations using parts that conform to the specifications detailed in this Owner's Manual.

Genuine Ford and Motorcraft parts meet or exceed these specifications.

### Collision Repairs

We hope that you never experience a collision, but accidents happen sometimes.

Genuine Ford replacement collision parts meet our stringent requirements for fit, finish, structural integrity, corrosion protection and dent resistance. During vehicle development we validate that these parts deliver the intended level of protection as a whole system. A great way to know for sure you are getting this level of protection is to use genuine Ford replacement collision parts.

### Warranty on Replacement Parts

Genuine Ford and Motorcraft replacement parts are the only replacement parts that benefit from a Ford Warranty.

The Ford Warranty may not cover damage caused to your vehicle as a result of failed non-Ford parts.

For additional information, refer to the terms and conditions of the Ford Warranty.

## MOBILE COMMUNICATIONS EQUIPMENT



**WARNING:** Driving while distracted can result in loss of vehicle control, crash and injury. We strongly recommend that you use extreme caution when using any device that may take your focus off the road. Your primary responsibility is the safe operation of your vehicle. We recommend against the use of any hand-held device while driving and encourage the use of voice-operated systems when possible. Make sure you are aware of all applicable local laws that may affect the use of electronic devices while driving.

# Introduction

Using mobile communications equipment is becoming increasingly important in the conduct of business and personal affairs. However, you must not compromise your own or others' safety when using such equipment. Mobile communications can enhance personal safety and security when appropriately used, particularly in emergency situations. Safety must be paramount when using mobile communications equipment to avoid negating these benefits. Mobile communication equipment includes, but is not limited to, cellular phones, pagers, portable email devices, text messaging devices and portable two-way radios.

## ABOUT THIS PUBLICATION



**WARNING:** Driving while distracted can result in loss of vehicle control, crash and injury. We strongly recommend that you use extreme caution when using any device that may take your focus off the road. Your primary responsibility is the safe operation of your vehicle. We recommend against the use of any hand-held device while driving and encourage the use of voice-operated systems when possible. Make sure you are aware of all applicable local laws that may affect the use of electronic devices while driving.

Thank you for choosing Ford. We recommend that you take some time to get to know your vehicle by reading this publication. The more that you know about your vehicle, the greater the safety and pleasure you will get from driving it.

**Note:** Use and operate your vehicle in line with all applicable laws and regulations.

**Note:** Pass on all printed owner's information when selling this vehicle.

## Features and Options

**Note:** This publication describes product features and options available throughout the range of available models, sometimes even before they are generally available. It could describe options that are not available on the vehicle you have purchased.

## Illustrations

**Note:** Some of the illustrations in this publication could show features as used in different models, so could appear different to you on your vehicle.

## Location of Components

This publication could qualify the location of a component as left-hand side or right-hand side. The side is determined when facing forward in the seat.

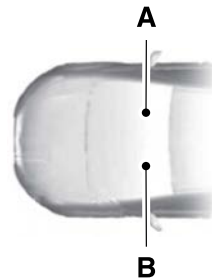

- A Right-hand side.
- B Left-hand side.

# Data Privacy



**WARNING:** Do not connect wireless plug-in devices to the data link connector. Unauthorized third parties could gain access to vehicle data and impair the performance of safety related systems. Only allow repair facilities that follow our service and repair instructions to connect their equipment to the data link connector.

We respect your privacy and are committed to protecting it. The information contained in this manual was correct at the time of publication, but as technology rapidly changes, we recommend that you visit the local Ford website for the latest information.

Your vehicle has electronic control units that have data recording functionality and the ability to permanently or temporarily store data. This data could include information on the condition and status of your vehicle, vehicle maintenance requirements, events and malfunctions. The types of data that can be recorded are described in this section. Some of the data recorded is stored in event logs or error logs.

**Note:** *Error logs are reset following a service or repair.*

**Note:** *We may provide information in response to requests from law enforcement, other government authorities and third parties acting with lawful authority or through a legal process. Such information could be used by them in legal proceedings.*

Data recorded includes, for example:

- Operating states of system components, for example fuel level, tire pressure and battery charge level.
- Vehicle and component status, for example wheel speed, deceleration, lateral acceleration and seatbelt status.

- Events or errors in essential systems, for example headlamps and brakes.
- System responses to driving situations, for example airbag deployment and stability control.
- Environmental conditions, for example temperature.

Some of this data, when used in combination with other information, for example an accident report, damage to a vehicle or eyewitness statements, could be associated with a specific person.

## Services That We Provide

If you use our services, we collect and use data, for example account information, vehicle location and driving characteristics, that could identify you. We transmit this data through a dedicated, protected connection. We only collect and use data to enable your use of our services to which you have subscribed, with your consent or where permitted by law. For additional information, see the terms and conditions of the services to which you have subscribed.

For additional information about our privacy policy, refer to the local Ford website.

## Services That Third Parties Provide

We recommend that you review the terms and conditions and data privacy information for any services equipped with your vehicle or to which you subscribe. We take no responsibility for services that third parties provide.

# Data Privacy

---

## SERVICE DATA

Our dealers collect service data through the data link connector in your vehicle. They use service data, for example error logs, to help them if you take your vehicle for repair. They share this data with our technical team, if required, to help with diagnosis. In addition to using the information for diagnosis and repair, we use and share service data with our service providers, for example parts suppliers, where required and where permitted by law, for continuous improvement or with other information that we have about you, for example your contact information, to offer you products and services that may be of interest to you according to your preferences and where allowed by law. Our service providers are equally required by law to protect your data and retain it in accordance with data retention policies.

**Note:** *Third party repair facilities can also collect service data through the data link connector.*

## EVENT DATA

This vehicle is equipped with an event data recorder. The main purpose of an event data recorder is to record, in certain crash or near crash-like situations, such as an airbag deployment or hitting a road obstacle; this data will assist in understanding how a vehicle's systems performed. The event data recorder is designed to record data related to vehicle dynamics and safety systems for a short period of time, typically 30 seconds or less.

The event data recorder in this vehicle is designed to record such data as:

- How various systems in your vehicle were operating.
- Whether or not the driver and passenger seatbelts were buckled/fastened.
- How far (if at all) the driver was depressing the accelerator and/or the brake pedal.
- How fast the vehicle was traveling.
- Where the driver was positioning the steering wheel.

This data can help provide a better understanding of the circumstances in which crashes and injuries occur.

**Note:** *Event data recorder data is recorded by your vehicle only if a non-trivial crash situation occurs; no data is recorded by the event data recorder under normal driving conditions and no personal data or information (for example name, gender, age, and crash location) is recorded. However, parties, such as law enforcement, could combine the event data recorder data with the type of personally identifying data routinely acquired during a crash investigation.*

To read data recorded by an event data recorder, special equipment is required, and access to the vehicle or the event data recorder is needed. In addition to the vehicle manufacturer, other parties, such as law enforcement, that have such special equipment, can read the information if they have access to the vehicle or the event data recorder.



# Data Privacy

## SETTINGS DATA

Your vehicle has electronic control units that have the ability to store data based on your personalized settings. The data is stored locally in the vehicle or on devices that you connect to it, for example, a USB drive or digital music player. You can delete some of this data and also choose whether to share it through the services to which you subscribe. See **Settings** (page 538).

### Comfort and Convenience Data

Data recorded includes, for example:

- Seat and steering wheel position.
- Climate control settings.
- Radio presets.

### Entertainment Data

Data recorded includes, for example:

- Music, videos or album art.
- Contacts and corresponding address book entries.
- Navigation destinations.

## CONNECTED VEHICLE DATA - VEHICLES WITH: MODEM



The modem has a SIM. The modem was enabled when your vehicle was built and periodically sends messages to stay connected to the cell phone network, receive automatic software updates and send vehicle-related information to us, for example diagnostic information. These messages could include information that identifies your vehicle, the SIM and the electronic serial number of the modem. Cell phone network

service providers could have access to additional information, for example cell phone network tower identification. For additional information about our privacy policy, visit [www.FordConnected.com](http://www.FordConnected.com) or refer to your local Ford website.

**Note:** *The modem continues to send this information unless you disable the modem or stop the modem from sharing vehicle data by changing the modem settings. See **Connected Vehicle** (page 497).*

**Note:** *The service can be unavailable or interrupted for a number of reasons, for example environmental or topographical conditions and data plan coverage.*

**Note:** *To find out if your vehicle has a modem, visit [www.FordConnected.com](http://www.FordConnected.com).*

## MOBILE DEVICE DATA - VEHICLES WITH: SYNC 3

If you connect a mobile device to your vehicle, you can display data from your device on the touchscreen for example, music and album art. You can share your vehicle data with mobile apps on your device through the system. See **Apps** (page 537).

The mobile apps function operates by your connected device sending data to us in the United States. The data is encrypted and includes, for example, the vehicle identification number of your vehicle, the SYNC module serial number, odometer, enabled apps, usage statistics and debugging information. We retain it only as long as necessary to provide the service, to troubleshoot, for continuous improvement and to offer you products and services that may be of interest to you according to your preferences and where allowed by law.

# Data Privacy

---

If you connect a cell phone to the system, the system creates a profile that links to that cell phone. The cell phone profile enables more mobile features and efficient operation. The profile contains, for example data from your phonebook, read and unread text messages and call history, including history of calls when your cell phone was not connected to the system.

If you connect a media device, the system creates and retains a media device index of supported media content. The system also records a short diagnostic log of approximately 10 minutes of all recent system activity.

The cell phone profile, media device index and diagnostic log remain in your vehicle unless you delete them and are generally accessible only in your vehicle when you connect your cell phone or media device. If you no longer plan to use the system or your vehicle, we recommend you use the master reset function to erase the stored information. See **Settings** (page 538).

System data cannot be accessed without special equipment and access to your vehicle's module.

For additional information about our privacy policy, refer to the local Ford website.

**Note:** *To find out if your vehicle has connectivity technology, visit [www.FordConnected.com](http://www.FordConnected.com).*

## EMERGENCY CALL SYSTEM DATA

When the emergency call system is active, it may disclose to emergency services that your vehicle has been in a crash involving the deployment of an airbag or activation of the fuel pump shut-off. Certain versions or updates to the emergency call system may also be capable of electronically or verbally disclosing to emergency services

operators your vehicle location or other details about your vehicle or crash to assist emergency services operators to provide the most appropriate emergency services. If you do not want to disclose this information, do not activate the emergency call system.

Examples of data that the system transmits are:

- Vehicle identification number.
- Vehicle fuel type.
- Current time.
- Vehicle location and direction.
- Whether the call was automatically or manually initiated.
- Vehicle category.

**Note:** *You cannot deactivate emergency call systems that are required by law.*

# Environment

---

## **PROTECTING THE ENVIRONMENT**

You should play your part in protecting the environment. Correct vehicle usage and the authorized disposal of waste, cleaning and lubrication materials are significant steps toward this aim.

For additional information about our sustainability progress and initiatives, visit [www.sustainability.ford.com](http://www.sustainability.ford.com).

# Visual Search

## STEERING WHEEL - EXCLUDING: ST



- A Cruise control button. See **Using Cruise Control** (page 272).
- B Speed limiter button. See **Intelligent Speed Limiter** (page 319).
- C Voice control button. See **Using Voice Recognition** (page 515). See **Using Voice Recognition** (page 520).
- D Information display controls. See **General Information** (page 145).

## STEERING WHEEL - ST



- A Cruise control button. See **Using Cruise Control** (page 272).
- B Speed limiter button. See **Intelligent Speed Limiter** (page 317).
- C Sport mode button. See **Selecting a Drive Mode** (page 365). See **Selecting a Drive Mode** (page 365).
- D Information display controls. See **General Information** (page 145).
- E Drive mode button. See **Selecting a Drive Mode** (page 365). See **Selecting a Drive Mode** (page 365).
- F Voice control button. See **Using Voice Recognition** (page 515). See **Using Voice Recognition** (page 520).

# Visual Search

## INSTRUMENT PANEL - LHD

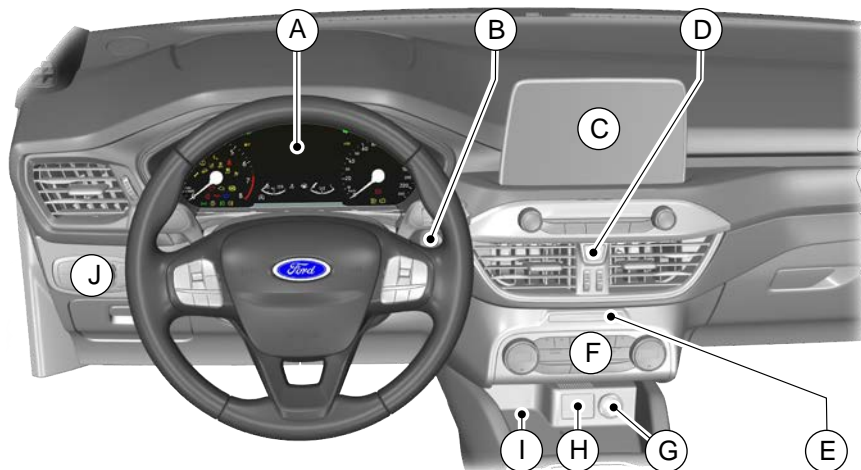

- A Instrument cluster. See **Gauges** (page 133).
- B Push button ignition switch. See **Push Button Ignition Switch** (page 193).
- C Audio unit. See **Audio System** (page 502). See **SYNC™ 3** (page 518).
- D Hazard flasher switch. See **Hazard Flashers** (page 390).
- E Passenger airbag deactivation indicator. See **Switching the Passenger Airbag On and Off** (page 53).
- F Climate controls. See **Climate Control** (page 162).
- G Auxiliary power point. See **Auxiliary Power Points** (page 188).
- H USB port. See **USB Port** (page 512).
- I Wireless accessory charger. See **Wireless Accessory Charger** (page 189).
- J Lighting control. See **Lighting Control** (page 106).

# Visual Search

## INSTRUMENT PANEL - RHD

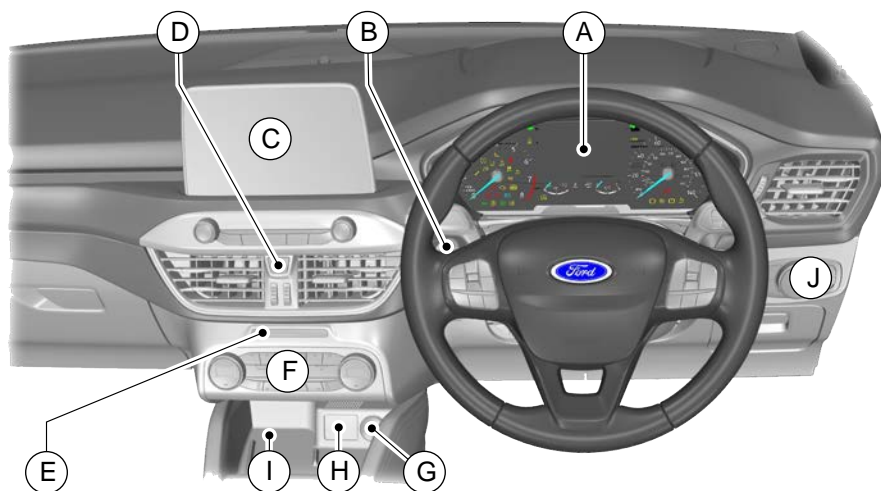

- A Instrument cluster. See **Gauges** (page 133).
- B Push button ignition switch. See **Push Button Ignition Switch** (page 193).
- C Audio unit. See **Audio System** (page 502). See **SYNC™ 3** (page 518).
- D Hazard flasher switch. See **Hazard Flashers** (page 390).
- E Passenger airbag deactivation indicator. See **Switching the Passenger Airbag On and Off** (page 53).
- F Climate controls. See **Climate Control** (page 162).
- G Auxiliary power point. See **Auxiliary Power Points** (page 188).
- H USB port. See **USB Port** (page 512).
- I Wireless accessory charger. See **Wireless Accessory Charger** (page 189).
- J Lighting control. See **Lighting Control** (page 106).

# Visual Search

## CENTER CONSOLE - AUTOMATIC TRANSMISSION, VEHICLES WITH: FRONT PARKING AID/HEAD UP DISPLAY (HUD)/REAR PARKING AID, VEHICLES WITHOUT: ACTIVE PARK ASSIST, EXCLUDING: ST

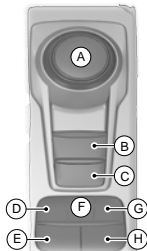

- A Transmission selector lever.
- B Electric parking brake. See **Electric Parking Brake** (page 247).
- C Auto hold button. See **Auto Hold** (page 252).
- D Drive mode button. See **Selecting a Drive Mode** (page 365).
- E Auto-Start-Stop button.
- F Traction control button. See **Using Traction Control** (page 254).
- G Head up display button. See **Head Up Display** (page 150).
- H Parking aid button. See **What is the Rear Parking Aid** (page 258). See **What is the Front Parking Aid** (page 258).

## CENTER CONSOLE - AUTOMATIC TRANSMISSION, VEHICLES WITHOUT: ACTIVE PARK ASSIST/FRONT PARKING AID/HEAD UP DISPLAY (HUD)/REAR PARKING AID, EXCLUDING: ST

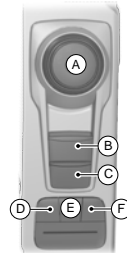

- A Transmission selector lever.
- B Electric parking brake. See **Electric Parking Brake** (page 247).
- C Auto hold button. See **Auto Hold** (page 252).
- D Drive mode button. See **Selecting a Drive Mode** (page 365).
- E Traction control button. See **Using Traction Control** (page 254).
- F Auto-Start-Stop button.

# Visual Search

**CENTER CONSOLE -  
AUTOMATIC TRANSMISSION,  
VEHICLES WITH: HEAD UP  
DISPLAY (HUD), VEHICLES  
WITHOUT: ACTIVE PARK  
ASSIST/FRONT PARKING AID/  
REAR PARKING AID,  
EXCLUDING: ST**

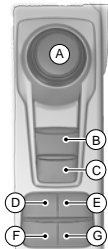

- A Transmission selector lever.
- B Electric parking brake. See **Electric Parking Brake** (page 247).
- C Auto hold button. See **Auto Hold** (page 252).
- D Drive mode button. See **Selecting a Drive Mode** (page 365).
- E Traction control button. See **Using Traction Control** (page 254).
- F Auto-Start-Stop button.
- G Head up display button. See **Head Up Display** (page 150).

**CENTER CONSOLE -  
AUTOMATIC TRANSMISSION,  
VEHICLES WITH: FRONT  
PARKING AID/REAR PARKING  
AID, VEHICLES WITHOUT:  
ACTIVE PARK ASSIST/HEAD  
UP DISPLAY (HUD),  
EXCLUDING: ST**

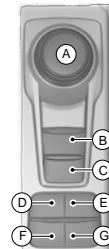

- A Transmission selector lever.
- B Electric parking brake. See **Electric Parking Brake** (page 247).
- C Auto hold button. See **Auto Hold** (page 252).
- D Drive mode button. See **Selecting a Drive Mode** (page 365).
- E Traction control button. See **Using Traction Control** (page 254).
- F Auto-Start-Stop button.
- G Parking aid button. See **What is the Rear Parking Aid** (page 258). See **What is the Front Parking Aid** (page 258).



# Visual Search

## CENTER CONSOLE - AUTOMATIC TRANSMISSION, VEHICLES WITH: ACTIVE PARK ASSIST/FRONT PARKING AID/ REAR PARKING AID, VEHICLES WITHOUT: HEAD UP DISPLAY (HUD), EXCLUDING: ST

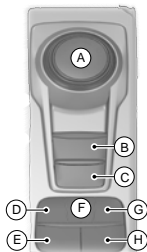

- A Transmission selector.
- B Electric parking brake. See **Electric Parking Brake** (page 247).
- C Auto hold button. See **Auto Hold** (page 252).
- D Drive mode button. See **Selecting a Drive Mode** (page 365).
- E Auto-Start-Stop button.
- F Traction control button. See **Using Traction Control** (page 254).
- G Active park assist button. See **Switching Active Park Assist On and Off** (page 267).
- H Parking aid button. See **What is the Rear Parking Aid** (page 258). See **What is the Front Parking Aid** (page 258).

## CENTER CONSOLE - AUTOMATIC TRANSMISSION, VEHICLES WITH: ACTIVE PARK ASSIST/FRONT PARKING AID/ HEAD UP DISPLAY (HUD)/ REAR PARKING AID, EXCLUDING: ST

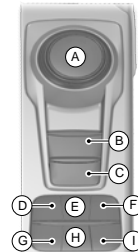

- A Transmission selector lever.
- B Electric parking brake. See **Electric Parking Brake** (page 247).
- C Auto hold button. See **Auto Hold** (page 252).
- D Drive mode button. See **Selecting a Drive Mode** (page 365).
- E Traction control button. See **Using Traction Control** (page 254).
- F Active park assist button. See **Switching Active Park Assist On and Off** (page 267).
- G Auto-Start-Stop button.

# Visual Search

- H Head up display button. See **Head Up Display** (page 150).
- I Parking aid button. See **What is the Rear Parking Aid** (page 258). See **What is the Front Parking Aid** (page 258).

- G Electric parking brake. See **Electric Parking Brake** (page 247).
- H Auto hold button. See **Auto Hold** (page 252).

## CENTER CONSOLE - MANUAL TRANSMISSION, LHD, EXCLUDING: ST

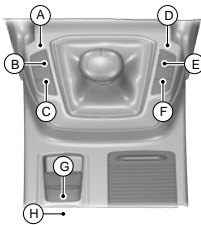

- A Auto-Start-Stop button.
- B Traction control switch. See **Using Traction Control** (page 254).
- C Drive mode control button. See **Selecting a Drive Mode** (page 365).
- D Head up display button. See **Head Up Display** (page 150).
- E Active park assist button. See **What Is Active Park Assist** (page 267).
- F Parking aid button. See **What is the Front Parking Aid** (page 258).

## CENTER CONSOLE - MANUAL TRANSMISSION, RHD, EXCLUDING: ST

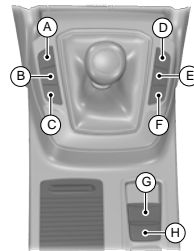

- A Parking aid button. See **What is the Front Parking Aid** (page 258).
- B Active park assist button. See **Switching Active Park Assist On and Off** (page 267).
- C Head up display button. See **Head Up Display** (page 150).
- D Drive mode control button. See **Selecting a Drive Mode** (page 365).
- E Traction control switch. See **Using Traction Control** (page 254).
- F Auto-Start-Stop button.

# Visual Search

- G Electric parking brake. See **Electric Parking Brake** (page 247).
- H Auto hold button. See **Auto Hold** (page 252).

- F Parking aid button. See **What is the Front Parking Aid** (page 258). See **What is the Rear Parking Aid** (page 258).
- G Active park assist button. See **Switching Active Park Assist On and Off** (page 267).

## CENTER CONSOLE - ST, AUTOMATIC TRANSMISSION, VEHICLES WITH: ACTIVE PARK ASSIST/FRONT PARKING AID/ REAR PARKING AID, VEHICLES WITHOUT: HEAD UP DISPLAY (HUD)

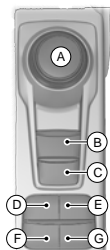

- A Transmission selector lever.
- B Electric parking brake. See **Electric Parking Brake** (page 247).
- C Auto hold button. See **Auto Hold** (page 252).
- D Auto-Start-Stop button.
- E Stability control button. See **Using Stability Control** (page 255).

## CENTER CONSOLE - ST, AUTOMATIC TRANSMISSION, VEHICLES WITH: FRONT PARKING AID/HEAD UP DISPLAY (HUD)/REAR PARKING AID, VEHICLES WITHOUT: ACTIVE PARK ASSIST

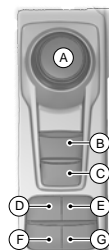

- A Transmission selector lever.
- B Electric parking brake. See **Electric Parking Brake** (page 247).
- C Auto hold button. See **Auto Hold** (page 252).
- D Head up display button. See **Head Up Display** (page 150).
- E Stability control button. See **Using Stability Control** (page 255).

# Visual Search

- F Auto-Start-Stop button.
- G Parking aid button. See **What is the Front Parking Aid** (page 258). See **What is the Rear Parking Aid** (page 258).

## CENTER CONSOLE - ST, AUTOMATIC TRANSMISSION, VEHICLES WITHOUT: ACTIVE PARK ASSIST/FRONT PARKING AID/HEAD UP DISPLAY (HUD)/REAR PARKING AID

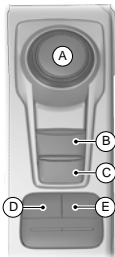

- A Transmission selector lever.
- B Electric parking brake. See **Electric Parking Brake** (page 247).
- C Auto hold button. See **Auto Hold** (page 252).
- D Auto-Start-Stop button.
- E Stability control button. See **Using Stability Control** (page 255).

## CENTER CONSOLE - ST, AUTOMATIC TRANSMISSION, VEHICLES WITH: HEAD UP DISPLAY (HUD), VEHICLES WITHOUT: ACTIVE PARK ASSIST/FRONT PARKING AID/REAR PARKING AID

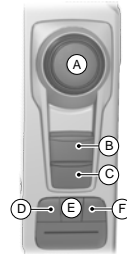

- A Transmission selector lever.
- B Electric parking brake. See **Electric Parking Brake** (page 247).
- C Auto hold button. See **Auto Hold** (page 252).
- D Head up display button. See **Head Up Display** (page 150).
- E Stability control button. See **Using Stability Control** (page 255).
- F Auto-Start-Stop button.

# Visual Search

## CENTER CONSOLE - ST, AUTOMATIC TRANSMISSION, VEHICLES WITH: FRONT PARKING AID/REAR PARKING AID, VEHICLES WITHOUT: ACTIVE PARK ASSIST/HEAD UP DISPLAY (HUD)

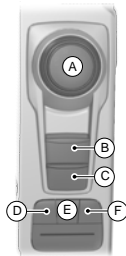

- A Transmission selector lever.
- B Electric parking brake. See **Electric Parking Brake** (page 247).
- C Auto hold button. See **Auto Hold** (page 252).
- D Parking aid button. See **What is the Front Parking Aid** (page 258). See **What is the Rear Parking Aid** (page 258).
- E Stability control button. See **Using Stability Control** (page 255).
- F Auto-Start-Stop button.

## CENTER CONSOLE - ST, AUTOMATIC TRANSMISSION, VEHICLES WITH: ACTIVE PARK ASSIST/FRONT PARKING AID/ HEAD UP DISPLAY (HUD)/ REAR PARKING AID

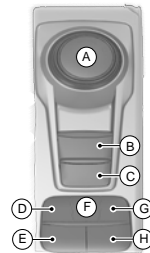

- A Transmission selector lever.
- B Electric parking brake. See **Electric Parking Brake** (page 247).
- C Auto hold button. See **Auto Hold** (page 252).
- D Head up display button. See **Head Up Display** (page 150).
- E Auto-Start-Stop button.
- F Stability control button. See **Using Stability Control** (page 255).
- G Active park assist button. See **Switching Active Park Assist On and Off** (page 267).
- H Parking aid button. See **What is the Front Parking Aid** (page 258). See **What is the Rear Parking Aid** (page 258).

# Visual Search

## CENTER CONSOLE - ST, MANUAL TRANSMISSION, LHD

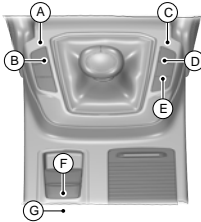

- A Auto-Start-Stop button.
- B Stability control button. See **Using Stability Control** (page 255).
- C Head up display button. See **Head Up Display** (page 150).
- D Active park assist button. See **Switching Active Park Assist On and Off** (page 267).
- E Parking aid button. See **What is the Front Parking Aid** (page 258).
- F Electric parking brake. See **Electric Parking Brake** (page 247).
- G Auto hold button. See **Auto Hold** (page 252).

## CENTER CONSOLE - ST, MANUAL TRANSMISSION, RHD

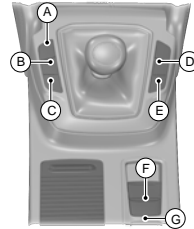

- A Parking aid button. See **What is the Front Parking Aid** (page 258).
- B Active park assist button. See **Switching Active Park Assist On and Off** (page 267).
- C Head up display button. See **Head Up Display** (page 150).
- D Stability control button. See **Using Stability Control** (page 255).
- E Auto-Start-Stop button.
- F Electric parking brake. See **Electric Parking Brake** (page 247).
- G Auto hold button. See **Auto Hold** (page 252).

# Child Safety

## INSTALLING CHILD RESTRAINTS - 4-DOOR



E161855



E68916

**WARNING:** Extreme Hazard! Never use a rearward facing child restraint on a seat protected by an active airbag in front of it. Death or serious injury to the child can occur.

**WARNING:** You must switch the passenger airbag off when using a rearward facing child restraint on the front seat.

**WARNING:** You must switch the passenger airbag on following the removal of the child restraint.

**WARNING:** Read and follow the manufacturer's instructions when you are installing a child restraint.

**WARNING:** Do not modify child restraints in any way.

**WARNING:** Do not hold a child on your lap when your vehicle is moving.

**WARNING:** Do not leave children or pets unattended in your vehicle. Failure to follow this instruction could result in personal injury or death.

**WARNING:** If your vehicle has been involved in a crash, have the child restraints checked.

Only child restraints certified to ECE-R129 or ECE-R44.03 (or later) have been tested and approved for use in your vehicle. A choice of these are available from an authorized dealer.

**Note:** *Mandatory use of child restraints varies from country to country.*

When using a child restraint on a front seat, follow these seat positioning guidelines:

- The child restraint must not be in contact with the instrument panel.
- Position the passenger seat as far rearward as possible and route the seatbelt forward and downward from the B-pillar ring to the child restraint.
- If it proves difficult to tighten the lap section of the seatbelt without slack remaining, adjust the seat backrest to the fully upright position and raise the height of the seat.

**Note:** *When using a child restraint on a rear seat, adjust the front seat to a position to prevent contact with the child's feet or legs.*

# Child Safety

## Child Restraints for Different Mass Groups

Use the correct child restraint as follows:

### Baby Safety Restraint (Group 0+)



Secure children that weigh less than 13 kg (29 lb) in a rearward facing baby safety restraint (Group 0+) on the rear seat.

### Child Safety Restraint (Group 1)



Secure children that weigh between 13 kg (29 lb) and 18 kg (40 lb) in a child safety restraint (Group 1) on the rear seat.

## Booster Seats

**WARNING:** Do not install a booster seat or a booster cushion with only the lap strap of the seatbelt.

**WARNING:** Do not install a booster seat or a booster cushion with a seatbelt that is slack or twisted.

**WARNING:** Do not put the shoulder section of the seatbelt or allow the child to put the shoulder section of the seatbelt under their arm or behind their back. Failure to follow this instruction could reduce the effectiveness of the seatbelt and increase the risk of injury or death in a crash.

**WARNING:** Do not use pillows, books or towels to boost your child's height. Failure to follow this instruction could result in personal injury or death.

**WARNING:** Make sure that your children sit in an upright position.

**WARNING:** Make sure the child restraint rests tightly against the vehicle seat. If necessary, adjust the seat backrest to an upright position. It may also be necessary to lift or remove the head restraint.

**WARNING:** You must reinstall the head restraint following the removal of the child restraint.



# Child Safety

## Booster Seat (Group 2)



Secure children that weigh greater than 15 kg (33 lb) but are less than 150 cm (60 in) tall in a booster seat or on a booster cushion.

We recommend that you use a booster seat that combines a cushion with a backrest instead of a booster cushion only. The raised seating position will allow you to position the shoulder strap of the adult seatbelt over the center of your child's shoulder and the lap strap tightly across their hips.

## Booster Cushion (Group 3)

**WARNING:** When using a booster cushion, make sure you adjust the vehicle head restraint on that seating position.



Secure children that weigh greater than 22 kg (49 lb) but are less than 150 cm (60 in) tall on a booster cushion.

## ISOFIX Anchor Points

**WARNING:** Use an anti-rotation device when using the ISOFIX system. Failure to follow this instruction could result in personal injury or death.

Your vehicle has ISOFIX anchor points that accommodate universally approved ISOFIX child restraints.

Always follow the manufacturer's instructions for installing a child restraint with a top tether.



The ISOFIX system has two rigid attachment arms on the child restraint. These attach to anchor points on the outermost rear seats, where the cushion and backrest meet.

**Note:** If you are purchasing an ISOFIX child restraint, make sure that you know the correct mass group and ISOFIX size class for the intended seating locations. See **Child Restraint Positioning** (page 43).

# Child Safety

## Top Tether Anchor Points

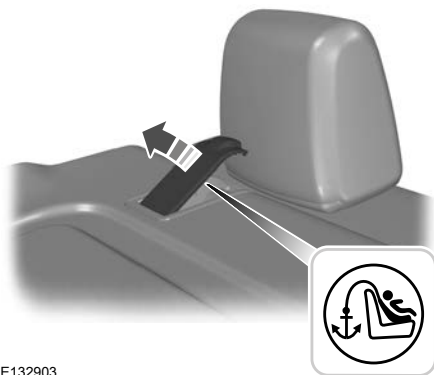

E132903

For child restraints with a top tether, tether anchor points are behind the second row seats.

### Attaching a Child Restraint With Top Tethers



**WARNING:** Do not attach the top tether strap to anything other than the correct top tether strap anchor point.



**WARNING:** Make sure that the top tether strap is not slack or twisted and is properly located on the anchor point.

1. Attach the tether strap to the anchor point.

**Note:** Where applicable, remove the luggage cover to ease installation. See **Luggage Covers** (page 374).

**Note:** You may need to lift or remove the head restraint to ease installation. See **Head Restraints** (page 177).

2. Remove the ISOFIX lower anchor point covers.



3. Push the child restraint back firmly to engage the ISOFIX lower anchor points.
4. Tighten the tether strap in line with the child restraint manufacturer's instructions.

### Attaching a Child Restraint With a Support Leg



**WARNING:** If you use a child restraint that has a support leg, make sure the support leg rests securely on the floor.



**WARNING:** Always make sure your child is secured properly in a device that is appropriate for their height, age and weight. Child safety restraints must be bought separately from your vehicle. Failure to follow these instructions and guidelines may result in an increased risk of serious injury or death to your child.



**WARNING:** Make sure that the child restraint manufacturer lists your vehicle as suitable for use with this type of child restraint.

# Child Safety



E185352

Always follow the manufacturer's instructions for installing a child restraint with a support leg.

## INSTALLING CHILD RESTRAINTS - 5-DOOR/WAGON



E161855



E68916

**WARNING:** Extreme Hazard! Never use a rearward facing child restraint on a seat protected by an active airbag in front of it. Death or serious injury to the child can occur.

**WARNING:** You must switch the passenger airbag off when using a rearward facing child restraint on the front seat.

**WARNING:** You must switch the passenger airbag on following the removal of the child restraint.

**WARNING:** Read and follow the manufacturer's instructions when you are installing a child restraint.

**WARNING:** Do not modify child restraints in any way.

**WARNING:** Do not hold a child on your lap when your vehicle is moving.

**WARNING:** Do not leave children or pets unattended in your vehicle. Failure to follow this instruction could result in personal injury or death.

# Child Safety



**WARNING:** If your vehicle has been involved in a crash, have the child restraints checked.

Only child restraints certified to ECE-R129 or ECE-R44.03 (or later) have been tested and approved for use in your vehicle. A choice of these are available from an authorized dealer.

**Note:** *Mandatory use of child restraints varies from country to country.*

When using a child restraint on a front seat, follow these seat positioning guidelines:

- The child restraint must not be in contact with the instrument panel.
- Position the passenger seat as far rearward as possible and route the seatbelt forward and downward from the B-pillar ring to the child restraint.
- If it proves difficult to tighten the lap section of the seatbelt without slack remaining, adjust the seat backrest to the fully upright position and raise the height of the seat.

**Note:** *When using a child restraint on a rear seat, adjust the front seat to a position to prevent contact with the child's feet or legs.*

## Child Restraints for Different Mass Groups

Use the correct child restraint as follows:

### Baby Safety Restraint (Group 0+)



Secure children that weigh less than 13 kg (29 lb) in a rearward facing baby safety restraint (Group 0+) on the rear seat.

### Child Safety Restraint (Group 1)



Secure children that weigh between 13 kg (29 lb) and 18 kg (40 lb) in a child safety restraint (Group 1) on the rear seat.

### Booster Seats



**WARNING:** Do not install a booster seat or a booster cushion with only the lap strap of the seatbelt.

# Child Safety

 **WARNING:** Do not install a booster seat or a booster cushion with a seatbelt that is slack or twisted.

 **WARNING:** Do not put the shoulder section of the seatbelt or allow the child to put the shoulder section of the seatbelt under their arm or behind their back. Failure to follow this instruction could reduce the effectiveness of the seatbelt and increase the risk of injury or death in a crash.

 **WARNING:** Do not use pillows, books or towels to boost your child's height. Failure to follow this instruction could result in personal injury or death.

 **WARNING:** Make sure that your children sit in an upright position.

 **WARNING:** Make sure the child restraint rests tightly against the vehicle seat. If necessary, adjust the seat backrest to an upright position. It may also be necessary to lift or remove the head restraint.

 **WARNING:** You must reinstall the head restraint following the removal of the child restraint.

## Booster Seat (Group 2)



Secure children that weigh greater than 15 kg (33 lb) but are less than 150 cm (60 in) tall in a booster seat or on a booster cushion.

We recommend that you use a booster seat that combines a cushion with a backrest instead of a booster cushion only. The raised seating position will allow you to position the shoulder strap of the adult seatbelt over the center of your child's shoulder and the lap strap tightly across their hips.

## Booster Cushion (Group 3)

 **WARNING:** When using a booster cushion, make sure you adjust the vehicle head restraint on that seating position.



Secure children that weigh greater than 22 kg (49 lb) but are less than 150 cm (60 in) tall on a booster cushion.

## ISOFIX Anchor Points

 **WARNING:** Use an anti-rotation device when using the ISOFIX system. Failure to follow this instruction could result in personal injury or death.

# Child Safety

Your vehicle has ISOFIX anchor points that accommodate universally approved ISOFIX child restraints.

Always follow the manufacturer's instructions for installing a child restraint with a top tether.



The ISOFIX system has two rigid attachment arms on the child restraint. These attach to anchor points on the outermost rear seats, where the cushion and backrest meet.

**Note:** If you are purchasing an ISOFIX child restraint, make sure that you know the correct mass group and ISOFIX size class for the intended seating locations. See **Child Restraint Positioning** (page 43).

## Top Tether Anchor Points



For child restraints with a top tether, tether anchor points are on the back of the second row seats.

## Attaching a Child Restraint With Top Tethers



**WARNING:** Do not attach the top tether strap to anything other than the correct top tether strap anchor point.



**WARNING:** Make sure that the top tether strap is not slack or twisted and is properly located on the anchor point.

1. Attach the tether strap to the anchor point.

**Note:** Where applicable, remove the luggage cover to ease installation. See **Luggage Covers** (page 374).

**Note:** You may need to lift or remove the head restraint to ease installation. See **Head Restraints** (page 177).

2. Remove the ISOFIX lower anchor point covers.

# Child Safety



3. Push the child restraint back firmly to engage the ISOFIX lower anchor points.
4. Tighten the tether strap in line with the child restraint manufacturer's instructions.

## Attaching a Child Restraint With a Support Leg



**WARNING:** If you use a child restraint that has a support leg, make sure the support leg rests securely on the floor.



**WARNING:** Always make sure your child is secured properly in a device that is appropriate for their height, age and weight. Child safety restraints must be bought separately from your vehicle. Failure to follow these instructions and guidelines may result in an increased risk of serious injury or death to your child.



**WARNING:** Make sure that the child restraint manufacturer lists your vehicle as suitable for use with this type of child restraint.



E185352

Always follow the manufacturer's instructions for installing a child restraint with a support leg.

## CHILD RESTRAINT POSITIONING



**WARNING: Extreme Hazard!** Never use a rearward facing child restraint on a seat protected by an active airbag in front of it. Death or serious injury to the child can occur.



**WARNING:** If you use a child restraint that has a support leg, make sure the support leg rests securely on the floor.



**WARNING:** If you use a child restraint and a seatbelt, make sure that the seatbelt is not slack or twisted.

# Child Safety



**WARNING:** Make sure the child restraint rests tightly against the vehicle seat. If necessary, adjust the seat backrest to an upright position. It may also be necessary to lift or remove the

head restraint.



**WARNING:** You must reinstall the head restraint following the removal of the child restraint.

Seating Positions	Mass Group Categories				
	0	0+	1	2	3
	0–10 kg (0–22 lb)	0–13 kg (0–29 lb)	9–18 kg (20–40 lb)	15–25 kg (33–55 lb)	22–36 kg (49–79 lb)
Front passenger seat with airbag <b>ON</b> .	X	X	UF <sup>1</sup>	UF <sup>1</sup>	UF <sup>1</sup>
Front passenger seat with airbag <b>OFF</b> .	U <sup>1</sup>	U <sup>1</sup>	U <sup>1</sup>	U <sup>1</sup>	U <sup>1</sup>
Rear seats. <sup>2</sup>	U	U	U	U	U

<sup>1</sup> We recommend that you secure children in a government approved child restraint, on the rear seat.

<sup>2</sup> Do not use a child restraint with a support leg on the rear center seat unless stated as suitable in the child restraint manufacturer's product information.

**X** Not suitable for children in this mass group.

**U** Suitable for universal category child restraints approved for use in this mass group.

**UF** Suitable for universal category forward facing child restraints approved for use in this mass group.



# Child Safety

## ISOFIX Child Restraints

Seating Positions		Mass Group Categories			
		0	0+	1	1
		Rearward Facing	Rearward Facing	Forward Facing	Rearward Facing
		0–10 kg (0–22 lb)	0–13 kg (0–29 lb)	9–18 kg (20–40lb)	9–18 kg (20–40lb)
Front passenger seat.	Size class.	No ISOFIX			
	Seat type.				
Rear outermost seat ISOFIX.	Size class.	C, D, E <sup>1</sup>		A, B, B1 <sup>1</sup>	C, D <sup>1</sup>
	Seat type.	IL		IL, IUF	IL
Rear center seat.	Size class.	No ISOFIX			
	Seat type.				

<sup>1</sup>The capital letters A to G define the ISOFIX size class for both universal and semi-universal child restraint systems. You can see the identification letters on ISOFIX child restraints.

**IL** Suitable for use with particular ISOFIX child restraint systems in the semi-universal category. Refer to the child restraint system manufacturer vehicle recommendation list for additional information.

**IUF** Suitable for use with forward facing ISOFIX child restraint systems in the universal category.

## Recommended Child Restraints

Mass Group Categories	Manufacturer	Model	Attachment
0+ 0–13 kg (0–29 lb)	Britax Römer.	Baby Safe Plus with ISOFIX base. <sup>1</sup>	ISOFIX base or seatbelt only.
1 9–18 kg (20–40 lb)	Britax Römer.	Duo Plus. <sup>1</sup>	ISOFIX and top tether anchors or seatbelt only.
2	Britax Römer.	KidFix. <sup>1, 2</sup>	ISOFIX and seatbelt or seatbelt only.

# Child Safety

Mass Group Categories	Manufacturer	Model	Attachment
15–25 kg (33–55 lb)			
3 22–36 kg (49–79 lb)	Britax Römer.	KidFix. <sup>1,2</sup>	ISOFIX and seatbelt or seatbelt only.

<sup>1</sup>We recommend that you secure children using an ISOFIX child restraint on the rear outermost seats.

<sup>2</sup>We recommend that you use a booster seat that combines a cushion with a backrest instead of a booster cushion only.

See an authorized dealer for the latest details relating to our recommended child restraints.

## i-Size Child Restraints

	Front Passenger Seat	Rear Outermost Seats	Rear Center Seat
i-Size child restraint systems.	X	i-U	X

**i-U** Suitable for use with forward and rearward facing i-Size child restraint systems.

**X** Not suitable for use with i-Size child restraint systems.

# Child Safety

## CHILD SAFETY LOCKS - VEHICLES WITH: MECHANICAL CHILD PROOF LOCKS



**WARNING:** You cannot open the rear doors from inside if you have put the child safety locks on.



A child safety lock is on the rear edge of each rear door. You must set the child safety lock separately on each door.

### Left-Hand Side

Turn the key clockwise to switch the child lock on and counterclockwise to switch it off.

### Right-Hand Side

Turn the key counterclockwise to switch the child lock on and clockwise to switch it off.

## CHILD SAFETY LOCKS - VEHICLES WITH: REMOTE CHILD PROOF LOCKS



**WARNING:** You cannot open the rear doors from inside if you have put the child safety locks on.

The child safety lock control is on the driver door.



Press the control to switch the child safety locks on. Press the control again to switch them off.

A LED (light emitting diode) on the child safety lock control illuminates when you switch them on. If the LED flashes, try to switch the child safety locks on again. If the LED continues to flash, have your vehicle checked as soon as possible.

**Note:** *You cannot use the rear power window controls if you switch the child safety locks on.*

## Child Safety Locks Information Messages

Message	Action
Child lock malfunction See manual	Try to switch the child safety locks on again. If the message continues to appear, have your vehicle checked as soon as possible.

# Seatbelts

## FASTENING THE SEATBELTS

**WARNING:** Make sure that the seatbelts are securely stowed away when not in use and not outside your vehicle when closing the doors.

**WARNING:** Accessory seat covers not released by Ford could prevent the seatbelt from retracting correctly. This could cause the seatbelt to become slack which could increase the risk of injuries in a crash.



1. Pull the seatbelt out steadily.

**Note:** *It may lock if you pull it sharply or if the vehicle is on a slope.*

2. Insert the tongue into the buckle until you hear a distinct click.

Press the red button on the buckle to release the seatbelt. Hold the seatbelt tongue and let it retract completely and smoothly to its stowed position.

## Using Seatbelts During Pregnancy

**WARNING:** Position the seatbelt correctly for your safety and that of your unborn child. Do not use only the lap strap or the shoulder strap.

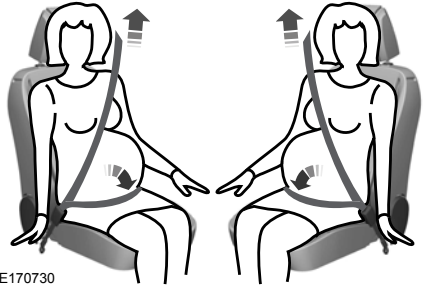

E170730

Pregnant women should always wear their seatbelt. The lap belt portion of a combination lap and shoulder belt should be positioned low across the hips below the belly and worn as tight as comfort will allow. The shoulder belt portion of a combination lap and shoulder belt should be positioned to cross the middle of the shoulder and the center of the chest.

## SEATBELT HEIGHT ADJUSTMENT

**WARNING:** Position the seatbelt height adjuster so that the seatbelt rests across the middle of your shoulder. Failure to adjust the seatbelt correctly could reduce its effectiveness and increase the risk of injury in a crash.

# Seatbelts



E183582

1. Press the button and slide the height adjuster up or down.
2. Release the button and pull down on the height adjuster to make sure it is locked in place.

## SEATBELT REMINDER - VEHICLES WITH: 4.2 INCH INSTRUMENT CLUSTER DISPLAY SCREEN

### Fasten Seatbelt Warning Lamp

A warning lamp illuminates if the ignition is on and any of the following occur:

- A front seat is occupied and the seatbelt has not been fastened.
- A rear seatbelt has been recently unfastened.



The warning lamp illuminates until you fasten your seatbelt.

### Fasten Seatbelt Audible Warning

A warning tone sounds if the warning lamp illuminates and your vehicle exceeds a relatively low speed.

The warning tone sounds for up to five minutes or until you fasten your seatbelt.

### Switching the Audible Warning Off

We recommend that you contact an authorized dealer.

### Seatbelt Status

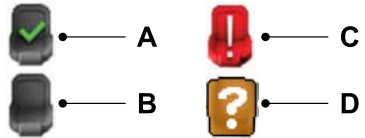

- A Seatbelt fastened.
- B Seatbelt not fastened.
- C Rear seatbelt recently unfastened.
- D Fault.

# Seatbelts

To view the seatbelt status, use the information display controls on the steering wheel to select the following:

Menu Item	Action
Settings	Press the menu button.
Information	Press the <b>OK</b> button.
Seatbelts	Press the <b>OK</b> button.

## Seatbelt Status Information Messages

Message	Description
Rear belt monitor malfunction Service required	The system has detected a fault that requires service. Have your vehicle checked as soon as possible.

## SEATBELT REMINDER - VEHICLES WITH: 12.3 INCH INSTRUMENT CLUSTER DISPLAY SCREEN

### Fasten Seatbelt Warning Lamp

A warning lamp illuminates if the ignition is on and any of the following occur:

- A front seat is occupied and the seatbelt has not been fastened.
- A rear seatbelt has been recently unfastened.



The warning lamp illuminates until you fasten your seatbelt.

### Fasten Seatbelt Audible Warning

A warning tone sounds if the warning lamp illuminates and your vehicle exceeds a relatively low speed.

The warning tone sounds for up to five minutes or until you fasten your seatbelt.

## Switching the Audible Warning Off

We recommend that you contact an authorized dealer.

## Seatbelt Status

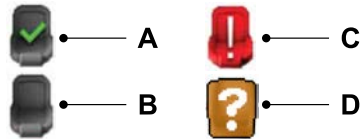

- A Seatbelt fastened.
- B Seatbelt not fastened.
- C Rear seatbelt recently unfastened.
- D Fault.

# Seatbelts

---

## Checking Seatbelt Status

1. Press the menu button on the steering wheel to enter the information display
2. Select **Select screens**.
3. Select **Seatbelts**.

main menu.

## Seatbelt Status Information Messages

<b>Message</b>	<b>Description</b>
Rear belt monitor malfunction Service required	The system has detected a fault that requires service. Have your vehicle checked as soon as possible.

# Supplementary Restraints System

## PRINCIPLE OF OPERATION

**WARNING:** Extreme Hazard! Never use a rearward facing child restraint on a seat protected by an active airbag in front of it. Death or serious injury to the child can occur.

**WARNING:** Do not modify the front of your vehicle in any way. This could adversely affect deployment of the airbags. Failure to adhere to this warning could result in serious personal injury or death.

**WARNING:** Wear a seatbelt and keep sufficient distance between yourself and the steering wheel. Only when you use the seatbelt correctly, can it hold you in a position that allows the airbag to achieve its optimum effect. Failure to adhere to this warning could result in serious personal injury or death.

**WARNING:** Repairs to the steering wheel, steering column, seats, airbags and seatbelts must be carried out by an authorized dealer. Failure to adhere to this warning could result in serious personal injury or death.

**WARNING:** Keep the areas in front of the airbags free from obstruction. Do not affix anything to or over the airbag covers. Objects could become projectiles during airbag deployment. Failure to follow this instruction could result in personal injury or death.

**WARNING:** Do not poke sharp objects into areas where airbags are fitted. This could damage and adversely affect deployment of the airbags. Failure to follow this instruction could result in personal injury or death.

**WARNING:** Accessory seat covers not released by Ford Motor Company could prevent the deployment of the airbags and increase the risk of injuries in a crash.

**Note:** A loud bang sounds and there is a cloud of harmless powdery residue if an airbag deploys. This is normal.

For routine cleaning, wipe the surface with a soft, damp cloth.

## DRIVER AIRBAG

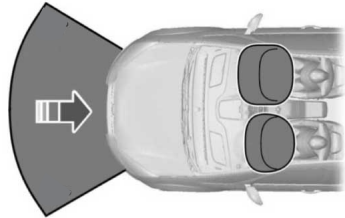

The airbag is designed to deploy during a significant frontal or near-frontal crash. The airbag inflates within a few thousandths of a second cushioning forward body movement and deflates on contact with the occupant. The airbag is not designed to deploy during a minor frontal crash, rear crash, side crash or a vehicle rollover.

## Airbag Warning Lamp



If it does not illuminate when you switch the ignition on, continues to flash or remains on when the engine is running, this indicates a malfunction. Have your vehicle checked as soon as possible.



# Supplementary Restraints System

## Airbag Secondary Warning Audible Warning

Sounds when the airbag warning lamp is not working.

## PASSENGER AIRBAG

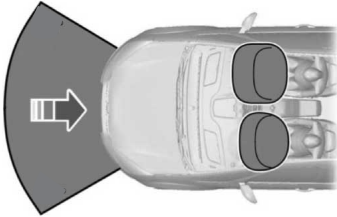

The airbag is designed to deploy during a significant frontal or near-frontal crash. The airbag inflates within a few thousandths of a second cushioning forward body movement and deflates on contact with the occupant. The airbag is not designed to deploy during a minor frontal crash, rear crash, side crash or a vehicle rollover.

## Airbag Warning Lamp



If it does not illuminate when you switch the ignition on, continues to flash or remains on when the engine is running, this indicates a malfunction. Have your vehicle checked as soon as possible.

## Airbag Secondary Warning Audible Warning

Sounds when the airbag warning lamp is not working.

## SWITCHING THE PASSENGER AIRBAG ON AND OFF - VEHICLES WITH: 4.2 INCH INSTRUMENT CLUSTER DISPLAY SCREEN



E71313

The passenger airbag on and off indicators are close to the climate control unit.

## Switching the Passenger Airbag Off

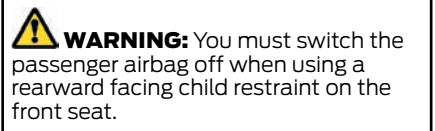

1. Using the information display controls on the steering wheel, select **Settings**.
2. Select **Vehicle settings**.
3. Select **Passenger airbag**.
4. Select **Off**.
5. Press and hold the **OK** button until a confirmation message appears in the information display.

# Supplementary Restraints System

- Switch the ignition off and on and check that the passenger airbag off indicator illuminates.

**Note:** *If it does not illuminate, this indicates a malfunction. Have your vehicle checked as soon as possible.*

## Switching the Passenger Airbag On



**WARNING:** You must switch the passenger airbag on following the removal of the child restraint.

- Using the information display controls on the steering wheel, select **Settings**.
- Select **Vehicle settings**.
- Select **Passenger airbag**.
- Select **On**.
- Press and hold the **OK** button until a confirmation message appears in the information display.
- Switch the ignition off and on and check that the passenger airbag on indicator illuminates.

**Note:** *If it does not illuminate, this indicates a malfunction. Have your vehicle checked as soon as possible.*

## SWITCHING THE PASSENGER AIRBAG ON AND OFF - VEHICLES WITH: 12.3 INCH INSTRUMENT CLUSTER DISPLAY SCREEN



E71313

The passenger airbag on and off indicators are close to the climate control unit.

## Switching the Passenger Airbag Off



**WARNING:** You must switch the passenger airbag off when using a rearward facing child restraint on the front seat.

- Press the menu button on the steering wheel to enter the information display main menu.
- Select **Settings**.
- Select **Vehicle**.
- Select **Passenger airbag**.
- Select **Passenger airbag off**.
- Press and hold the **OK** button for a few seconds.

# Supplementary Restraints System

7. Switch the ignition off and on and check that the passenger airbag off indicator illuminates.

**Note:** *If it does not illuminate, this indicates a malfunction. Have your vehicle checked as soon as possible.*

## Switching the Passenger Airbag On

 **WARNING:** You must switch the passenger airbag on following the removal of the child restraint.

1. Press the menu button on the steering wheel to enter the information display main menu.
2. Select **Settings**.
3. Select **Vehicle**.
4. Select **Passenger airbag**.
5. Select **Passenger airbag on**.
6. Press and hold the **OK** button for a few seconds.
7. Switch the ignition off and on and check that the passenger airbag on indicator illuminates.

**Note:** *If it does not illuminate, this indicates a malfunction. Have your vehicle checked as soon as possible.*

## SIDE AIRBAGS

 **WARNING:** Do not place objects or mount equipment on or near the headliner at the siderail that may come into contact with a deploying curtain airbag. Failure to follow these instructions may increase the risk of personal injury in the event of a crash.

 **WARNING:** Do not lean your head on the door. The side airbag could injure you as it deploys from the side of the seatback.

 **WARNING:** Accessory seat covers not released by Ford could prevent the deployment of the airbags and increase the risk of injuries in a crash.

 **WARNING:** Do not attempt to service, repair, or modify the supplementary restraint system or associated components. Failure to follow this instruction could result in personal injury or death.

 **WARNING:** If a supplementary restraint system component has deployed, it will not function again. Have the system and associated components inspected as soon as possible. Failure to follow this instruction could result in personal injury or death.



E72658

The side airbags are on the outermost side of each front seat backrest. There is a label attached to the side of each backrest to indicate this.

# Supplementary Restraints System



The side airbags are designed to inflate between the door panel and the occupant to enhance the protection in certain crashes.

The side airbags are designed to deploy during a significant lateral crash. They could also deploy during a significant frontal crash. The side airbags are not designed to deploy during a minor lateral or frontal crash, rear crash or a vehicle rollover.

## Airbag Warning Lamp



If it does not illuminate when you switch the ignition on, continues to flash or remains on when the engine is running, this indicates a malfunction. Have your vehicle checked as soon as possible.

## Airbag Secondary Warning Audible Warning

Sounds when the airbag warning lamp is not working.

## SIDE CURTAIN AIRBAGS



**WARNING:** Do not place objects or mount equipment on or near the headliner at the siderail that may come into contact with a deploying curtain airbag. Failure to follow these instructions may increase the risk of personal injury in the event of a crash.

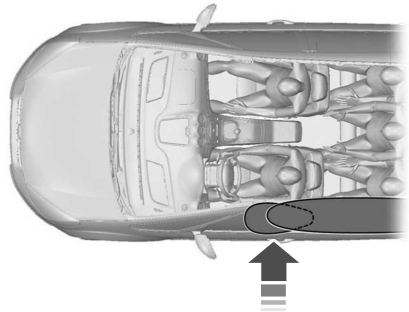

The curtain airbags are above the front and rear side windows.

The curtain airbags are designed to deploy during a significant lateral or frontal angled crash. The curtain airbags are not designed to deploy during a minor lateral and frontal crash, rear crash or a vehicle rollover.

## Airbag Warning Lamp



If it does not illuminate when you switch the ignition on, continues to flash or remains on when the engine is running, this indicates a malfunction. Have your vehicle checked as soon as possible.

## Airbag Secondary Warning Audible Warning

Sounds when the airbag warning lamp is not working.

# Automatic Crash Notification System

## EMERGENCY ASSISTANCE



**WARNING:** Unless the Emergency Assistance setting is on prior to a collision, the system does not attempt to place an emergency call. This could delay the response time, increasing the risk of serious injury or death.



**WARNING:** For this feature to work, your mobile phone must be Bluetooth-enabled and compatible with the system.



**WARNING:** Always place your phone in a secure location in your vehicle so it does not become a projectile or get damaged in a crash. Failure to do so may cause serious injury to someone or damage the phone which could prevent Emergency Assistance from working properly.

**Note:** *Not all accidents activate the system. If an accident does trigger the system, it initiates a call to the emergency services. Do not wait for the system to initiate a call if you are able to do so. Call emergency services immediately to avoid a delayed response time. If you do not hear the system within five seconds of the accident, the system could be non-functional.*

If an accident results in an attempt to deploy an airbag, excluding knee airbags and rear inflatable seatbelts, or to shut off the fuel pump, the system initiates a call to the emergency services.

**Note:** *Before setting the feature on, please read the important notice about the Emergency Assistance feature and the Emergency Assistance privacy notice later in this section for important information.*

**Note:** *When you switch Emergency Assistance on or off, the settings apply to all paired mobile phones. If you switch Emergency Assistance off and a previously paired phone connects when you switch the ignition on, either a voice message plays, a display message or icon is shown or both.*

**Note:** *Every mobile phone operates differently. While Emergency Assistance works with most mobile phones, some mobile phones may experience difficulties using this feature.*

**Note:** *In the case of an emergency, the system, as a means of communication aid, can help you contact specific rescue departments of public emergency services. The system does not deploy the rescue operations. The local public emergency service deploys specific rescue operations according to the actual situation.*

To make sure that Emergency Assistance works correctly:

- The system must have power and be working correctly at the time of the crash and during feature activation and use.
- You must switch on the feature before a crash.
- You must have a cell phone connected to the system.
- In certain countries, it may be necessary to have a valid and registered SIM card with credit in order to place and maintain an emergency call.
- A connected cell phone must have the ability to make and maintain an outgoing call at the time of the crash.
- A connected cell phone must have adequate network coverage, battery power and signal strength.
- Your vehicle must have battery power.

# Automatic Crash Notification System

---

**Note:** *This feature only works in a country where Emergency Assistance can call the local emergency services. For additional information, please refer to the local Ford website.*

## In the Event of a Crash

Before making a call:

- If you do not cancel the call, an introductory message plays for the emergency operator. After this message, there is hands-free communication between your vehicle's occupants and the operator.
- The system provides a short window of time (approximately 10 seconds) to cancel the call. If you do not cancel the call, the system initiates a call to the emergency services.
- The system plays a message letting you know when it attempts to make an emergency call. You can cancel the call by selecting the relevant button or by pressing the end call button on the steering wheel.

**Note:** *Not every crash deploys an airbag or triggers the fuel pump shut off, which may turn on Emergency Assistance. However, if Emergency Assistance is triggered, the system tries to contact the emergency services. If a connected cell phone sustains damage or loses connection to the system, it searches for and tries to connect to any available previously paired cell phone and initiates a call to the emergency services.*

During a call:

- Emergency Assistance uses your vehicle GPS or cellular network information when available to determine the most appropriate language to use. It alerts the emergency operator of the crash and delivers the introductory message. This may include your vehicle GPS coordinates.
- The language the system uses to interact with the occupants of your vehicle may differ from the language used to deliver information to the emergency operator.
- After the delivery of the introductory message the voice line opens so that you can speak hands-free with the emergency operator.
- When the line is connected, you must be prepared to provide your name, phone number and location information immediately.

**Note:** *While the system provides information to the emergency operator, the system plays a message letting you know it is sending important information. It then lets you know when the line is open to start hands-free communication.*

**Note:** *During an Emergency Assistance call, an emergency priority screen appears which contains vehicle GPS coordinates when available.*

**Note:** *It is possible that GPS location information is not available at the time of the crash; in this case, Emergency Assistance will still attempt to place an emergency call.*

**Note:** *It is possible that the emergency services will not receive the GPS coordinates; in this case, hands-free communication with an emergency operator is available.*

# Automatic Crash Notification System

---

**Note:** *The emergency operator may also receive information from the cellular network such as cell phone number, cell phone location and cell phone carrier name independent from Emergency Assistance.*

## **Emergency Assistance may not work if:**

- Your cell phone or Emergency Assistance hardware sustains damage in the crash.
- The vehicle battery or the system has no power.
- A crash ejects your cell phone from your vehicle.
- You do not have a valid and registered SIM card with credit in your cell phone.
- You are in a country where Emergency Assistance cannot call the local emergency services. For additional information, please refer to the local Ford website.

## **Important Information About Emergency Assistance**

Emergency Assistance does not currently call emergency services in the following countries:

- Albania.
- Armenia.
- Azerbaijan.
- Belarus.
- Bosnia and Herzegovina.
- Georgia.
- Macedonia.
- Moldova.
- Netherlands.
- Russia.
- Ukraine.

## **Emergency Assistance Privacy Notice**

When you switch on Emergency Assistance, it may disclose to emergency services that your vehicle has been in a crash involving the deployment of an airbag or activation of the fuel pump shut off. This feature has the capability to disclose your location information to the emergency operator or other details about your vehicle or crash to provide the most appropriate emergency services.

If you do not want to disclose this information, do not switch on the feature.

## WHAT IS ECALL

eCall is an emergency call system that complies with European Union Regulation (EU) 2015/758. See **eCall User Information** (page 553).

The system uses the public cell phone network to initiate a call to the public emergency services when activated automatically in a severe accident or manually by the vehicle occupants.

eCall is designed for emergency calls in case of severe accidents or other emergencies that require the emergency services. It does not support other voice calls.

## HOW DOES ECALL WORK

If an accident results in an attempt to deploy an airbag, excluding knee airbags and rear inflatable seatbelts, or to shut off the fuel pump, the system initiates a call to the emergency services. This call cannot be canceled.

In the case of an emergency, the system, as a means of communication aid, can help you contact specific rescue departments of public emergency services. The system does not deploy the rescue operations. The local public emergency service deploys specific rescue operations according to the actual situation.

During an emergency call, the system transmits vehicle data to the emergency service. See **Emergency Call System Data** (page 22).

**Note:** *If the transmission is unsuccessful, this could result in the emergency operator not receiving your vehicle data.*

**Note:** *If the system is unable to initiate a call to the emergency services, a voice prompt plays and the emergency call indicator illuminates.*

## EMERGENCY CALL REQUIREMENTS

The system only operates in areas with a compatible cell phone network and emergency services infrastructure.

## EMERGENCY CALL LIMITATIONS

Not all accidents activate the system. If an accident does trigger the system, it initiates a call to the emergency services. Do not wait for the system to initiate a call if you are able to do so. Call emergency services immediately to avoid a delayed response time. If you do not hear the system within five seconds of the accident, the system could be non-functional.

Using a non-Ford audio system could result in the system not properly operating.

## MANUALLY MAKING AN EMERGENCY CALL



**WARNING:** Use caution when making a manual emergency call when driving.

1. Switch the ignition on.
2. Press the SOS symbol on the overhead console to open the emergency call button cover.
3. Press the emergency call button to initiate a call to the emergency services.

**Note:** *Press the button again before the call is connected to cancel it.*

4. Speak to the operator.



**Note:** After completing an emergency call, the emergency operator can call your vehicle. The system automatically answers incoming calls for up to an hour.



The indicator is integrated into the emergency call button cover on the overhead console.

It illuminates brightly for a short time when you switch the ignition on.

## EMERGENCY CALL INDICATORS



**WARNING:** If the system malfunctions, have your vehicle checked as soon as possible.

<b>Emergency Call Indicator Status</b>	<b>Description</b>
Indicator off.	The system has malfunctioned. Have your vehicle checked as soon as possible.
Dimmed red.	Normal operation.
Rapidly flashing.	The system is initiating an emergency call.
Moderately flashing.	The system is transmitting vehicle data to the emergency services.
Slowly flashing.	The system is connected to the emergency services and communication is established.
Bright red.	The system has malfunctioned. Have your vehicle checked as soon as possible.

## **CHANGING THE BACKUP BATTERY**

The system has a backup battery and indicates when it needs to be changed. We recommend that you have the battery changed by an authorized dealer.

## **ECALL – TROUBLESHOOTING**

### **eCall – Information Messages**

<b>Message</b>	<b>Description</b>
Emergency call system malfunction Service required	The system has malfunctioned. Have your vehicle checked as soon as possible.

# Keys and Remote Controls

## REMOTE CONTROL LIMITATIONS

The typical operating range for your remote control is approximately 10 m (33 ft).

A decrease in operating range could be caused by:

- Weather conditions.
- Nearby radio towers.
- Structures around your vehicle.
- Other vehicles parked next to your vehicle.

The radio frequency used by your remote control can also be used by other short distance radio transmissions, for example amateur radios, medical equipment, wireless headphones, remote controls and alarm systems. If the frequencies are jammed, you will not be able to use your remote control. You can lock and unlock the doors with the key.

**Note:** Make sure you have locked your vehicle before leaving it unattended.

**Note:** If you are within range of your vehicle, the remote control will operate if you unintentionally press any button.

**Note:** The remote control contains sensitive electrical components. Exposure to moisture or impact may cause permanent damage.

## OPENING AND CLOSING THE FLIP KEY



Press the button to release the key. Press and hold the button to fold the key back when not in use.

## REMOVING THE KEY BLADE

The passive key contains a removable key blade that you can use to unlock your vehicle.

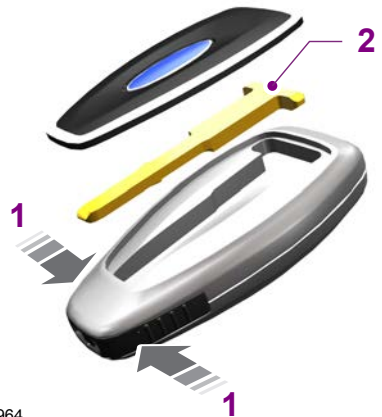

E87964

1. Press and hold the buttons on the edges of the transmitter to release the cover. Carefully remove the cover.
2. Remove the key blade from the transmitter.

# Keys and Remote Controls

## LOCATING YOUR VEHICLE



Press the lock button on the key twice within three seconds. The direction indicators will flash.

## CHANGING THE REMOTE CONTROL BATTERY - VEHICLES WITH: KEYLESS ENTRY



**WARNING:** Keep batteries away from children to prevent ingestion. Failure to follow this instruction could result in personal injury or death. If ingested, immediately seek medical attention.



**WARNING:** If the battery compartment does not securely close, stop using the remote control and replace it as soon as possible. In the meantime, keep the remote control away from children. Failure to follow this instruction could result in personal injury or death.



Make sure that you dispose of old batteries in an environmentally friendly way. Seek advice from your local authority about recycling old batteries.

The remote control uses one coin-type three-volt lithium battery CR2032 or equivalent.

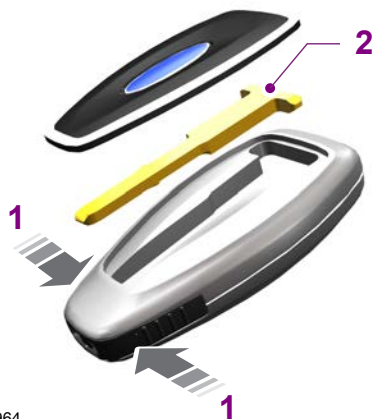

E87964

1. Press and hold the buttons on the edges of the transmitter to release the cover. Carefully remove the cover.
2. Remove the key blade from the transmitter.

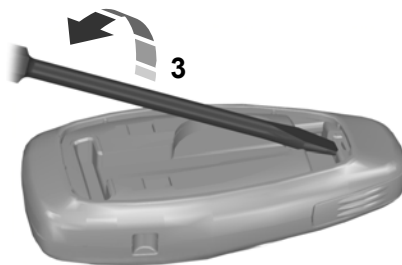

E105362

3. Use a suitable tool, for example a screwdriver, to carefully separate the two halves of the remote control.

# Keys and Remote Controls



E119190

4. Twist the screwdriver in the position shown to separate the two halves of the remote control.

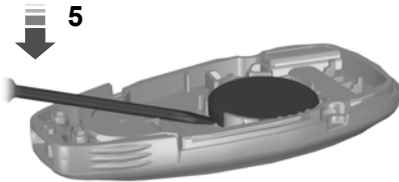

E125860

5. Carefully remove the battery with the screwdriver.

**Note:** Do not touch the battery contacts or the printed circuit board with the screwdriver.

6. Insert a new battery with the + facing downward.

**Note:** Do not wipe off any grease on the battery terminals or on the back surface of the circuit board.

7. Assemble the two halves of the remote control.
8. Reinstall the key blade.

## CHANGING THE REMOTE CONTROL BATTERY - VEHICLES WITH: REMOTE FLIP KEY

 **WARNING:** Keep batteries away from children to prevent ingestion. Failure to follow this instruction could result in personal injury or death. If ingested, immediately seek medical attention.

 **WARNING:** If the battery compartment does not securely close, stop using the remote control and replace it as soon as possible. In the meantime, keep the remote control away from children. Failure to follow this instruction could result in personal injury or death.



Make sure that you dispose of old batteries in an environmentally friendly way. Seek advice from your local authority about recycling old batteries.

The remote control uses one coin-type three-volt lithium battery CR2032 or equivalent.

1. Press the key release button.



## Keys and Remote Controls

2. Insert a suitable tool, for example a screwdriver, in the position shown and gently push the clip.
3. Press the clip down to release the battery cover.

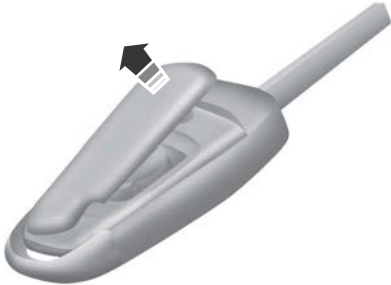

4. Carefully remove the cover.



5. Insert a screwdriver as shown to release the battery.

**Note:** Do not touch the battery contacts or the printed circuit board with the screwdriver.



6. Remove the battery.
7. Install a new battery with the + facing upward.
8. Replace the battery cover.

### REPLACING A LOST KEY OR REMOTE CONTROL

You can purchase replacement keys or remote controls from an authorized dealer. If possible, provide them with the key number from the tag provided with the original key. You can also obtain extra keys.

## KEYS AND REMOTE CONTROLS – TROUBLESHOOTING

### Keys and Remote Controls – Information Messages

Message	Action
Key battery low Replace soon	Displays when the remote control battery requires replacing.

# Keys and Remote Controls

---

## PASSIVE KEY BACKUP POSITION

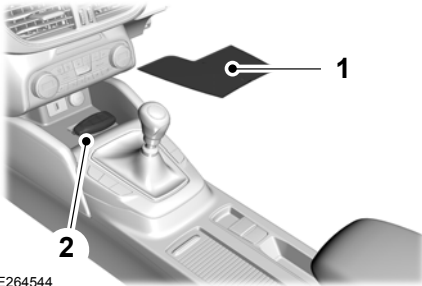

E264544

1. Remove the rubber mat.
2. Place the passive key in the position shown, with the buttons facing upward.

## WHAT IS MYKEY

MyKey allows you to program keys with restricted settings to promote good driving habits.

## MYKEY SETTINGS

### Non-Configurable MyKey Settings - Excluding: ST

#### Seatbelt Reminder

The audio system mutes when the seatbelt reminder turns on. The seatbelt reminder cannot be switched off with a MyKey.

#### Early Low Fuel

The low fuel level warning lamp turns on earlier.

#### Driving and Parking Aids

Parking aids, blind spot information system and cross traffic alert turn on when you start the engine and cannot be switched off with a MyKey.

Pre-collision assist and lane keeping alert turn on when you start the engine, but can be switched off with a MyKey.

A new destination in the navigation system can only be set using voice commands, when using a MyKey and your vehicle is moving.

### Non-Configurable MyKey Settings - ST

#### Seatbelt Reminder

The audio system mutes when the seatbelt reminder turns on. The seatbelt reminder cannot be switched off with a MyKey.

#### Early Low Fuel

The low fuel level warning lamp turns on earlier.

#### Driving and Parking Aids

Parking aids, blind spot information system and cross traffic alert turn on when you start the engine and cannot be switched off with a MyKey.

Pre-collision assist and lane keeping alert turn on when you start the engine, but can be switched off with a MyKey.

A new destination in the navigation system can only be set using voice commands, when using a MyKey and your vehicle is moving.

#### Selectable Drive Modes

You cannot select some drive modes when using a MyKey.

#### Stability Control

You cannot switch stability control off when using a MyKey.

### Configurable MyKey Settings

You can configure the following settings after creating a MyKey. See **Creating a MyKey** (page 69).

#### Speed Limit



**WARNING:** Do not set MyKey maximum speed limit to a limit that will prevent the driver from maintaining a safe speed considering posted speed limits and prevailing road conditions. The driver is always responsible to drive in accordance with local laws and prevailing conditions. Failure to do so could result in accident or injury.



You can set a speed limit for your vehicle. Warning messages appear in the information display and a tone sounds if your vehicle reaches the set speed. You cannot override the set speed when using a MyKey.

## Speed Reminder

You can set a speed reminder for your vehicle. Warning messages appear in the information display and a tone sounds if your vehicle exceeds the set speed.

## Audio System Volume Limit

The audio system maximum volume is reduced. A message appears in the information display if you attempt to exceed the volume limit. Automatic volume control turns off.

## Emergency Assistance

If you set emergency assistance to be always on, it cannot be switched off with a MyKey.

## Do Not Disturb

If you set do not disturb to be always on, it cannot be switched off with a MyKey.

## Traction Control

If you set traction control to be always on, it cannot be switched off with a MyKey.

## CREATING A MYKEY - VEHICLES WITH: 4.2 INCH INSTRUMENT CLUSTER DISPLAY SCREEN, VEHICLES WITHOUT: PUSH BUTTON START

1. Switch the ignition on using an admin key.

2. Using the information display controls on the steering wheel, select **Settings**.
3. Select **MyKey**.
4. Select **Create MyKey**.
5. Press and hold the **OK** button until a confirmation message appears in the information display.
6. Switch the ignition off.

**Note:** *We recommend that you label this key.*

## CREATING A MYKEY - VEHICLES WITH: 12.3 INCH INSTRUMENT CLUSTER DISPLAY SCREEN, VEHICLES WITHOUT: PUSH BUTTON START

1. Switch the ignition on using an admin key.
2. Press the menu button on the steering wheel to enter the information display main menu.
3. Select **Settings**.
4. Select **MyKey**.
5. Select **Create MyKey**.
6. Press and hold the **OK** button until a confirmation message appears in the information display.
7. Switch the ignition off.

**Note:** *We recommend that you label this key.*

## CREATING A MYKEY - VEHICLES WITH: 4.2 INCH INSTRUMENT CLUSTER DISPLAY SCREEN/KEYLESS ENTRY/PUSH BUTTON START

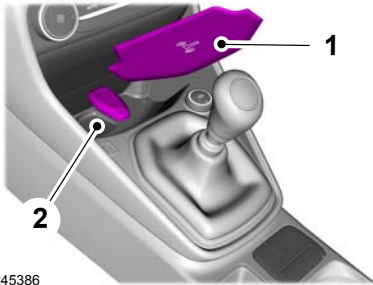

E245386

1. Remove the rubber mat.
2. Place the admin key in the position shown, with the buttons facing upward.
3. Switch the ignition on.
4. Using the information display controls on the steering wheel, select **Settings**.
5. Select **MyKey**.
6. Select **Create MyKey**.
7. Press and hold the **OK** button until a confirmation message appears in the information display.
8. Switch the ignition off.

**Note:** We recommend that you label this key.

## CREATING A MYKEY - VEHICLES WITH: 12.3 INCH INSTRUMENT CLUSTER DISPLAY SCREEN/KEYLESS ENTRY/PUSH BUTTON START

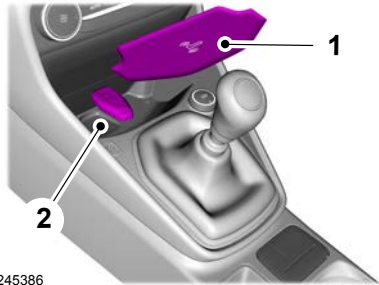

E245386

1. Remove the rubber mat.
2. Place the admin key in the position shown, with the buttons facing upward.
3. Switch the ignition on.
4. Press the menu button on the steering wheel to enter the information display main menu.
5. Select **Settings**.
6. Select **MyKey**.
7. Select **Create MyKey**.
8. Press and hold the **OK** button until a confirmation message appears in the information display.
9. Switch the ignition off.

**Note:** We recommend that you label this key.

## PROGRAMMING A MYKEY - VEHICLES WITH: 4.2 INCH INSTRUMENT CLUSTER DISPLAY SCREEN

You can only program MyKeys to the same settings.

1. Switch the ignition on using an admin key.
2. Using the information display controls on the steering wheel, select **Settings**.
3. Select **MyKey**.
4. Select a setting and press the **OK** button.
5. Configure the setting.
6. Switch the ignition off.

## PROGRAMMING A MYKEY - VEHICLES WITH: 12.3 INCH INSTRUMENT CLUSTER DISPLAY SCREEN

You can only program MyKeys to the same settings.

1. Switch the ignition on using an admin key.
2. Press the menu button on the steering wheel to enter the information display main menu.
3. Select **Settings**.
4. Select **MyKey**.
5. Select a setting and press the **OK** button.
6. Configure the setting.
7. Switch the ignition off.

## CLEARING ALL MYKEYS - VEHICLES WITH: 4.2 INCH INSTRUMENT CLUSTER DISPLAY SCREEN

When you clear all MyKeys, you remove all restrictions and return all MyKeys to their original admin key status.

1. Switch the ignition on using an admin key.
2. Using the information display controls on the steering wheel, select **Settings**.
3. Select **MyKey**.
4. Select **Clear MyKeys**.
5. Press and hold the **OK** button until a confirmation message appears in the information display.

## CLEARING ALL MYKEYS - VEHICLES WITH: 12.3 INCH INSTRUMENT CLUSTER DISPLAY SCREEN

When you clear all MyKeys, you remove all restrictions and return all MyKeys to their original admin key status.

1. Switch the ignition on using an admin key.
2. Press the menu button on the steering wheel to enter the information display main menu.
3. Select **Settings**.
4. Select **MyKey**.
5. Select **Clear MyKeys**.
6. Press and hold the **OK** button until a confirmation message appears in the information display.

## CHECKING MYKEY SYSTEM STATUS - VEHICLES WITH: 4.2 INCH INSTRUMENT CLUSTER DISPLAY SCREEN

You can find information about the distance traveled using a MyKey and also the number of admin keys and MyKeys created for your vehicle.

1. Switch the ignition on.
2. Using the information display controls on the steering wheel, select **Settings**.
3. Select **MyKey**.
4. Select **MyKey info**.

## CHECKING MYKEY SYSTEM STATUS - VEHICLES WITH: 12.3 INCH INSTRUMENT CLUSTER DISPLAY SCREEN

You can find information about the distance traveled using a MyKey and also the number of admin keys and MyKeys created for your vehicle.

1. Switch the ignition on.
2. Press the menu button on the steering wheel to enter the information display main menu.
3. Select **Settings**.
4. Select **MyKey**.
5. Select **MyKey info**.

## USING MYKEY WITH REMOTE START SYSTEMS

The system is not compatible with non-Ford remote start systems.

## MYKEY – TROUBLESHOOTING

### MyKey – Information Messages - Vehicles Without: Push Button Start

Message	Description
Key is already a MyKey	Displays when trying to create a MyKey with a key already designated as a MyKey.
Key restricted at next start. Label this key	Displays to confirm that the key is restricted after you switch the ignition off.

# MyKey™

## MyKey – Information Messages - Vehicles With: Keyless Entry

Message	Description
Place key in backup location	Displays when trying to create a MyKey and the admin key is not placed in the backup position. See <b>Creating a MyKey</b> (page 70).
Key is already a MyKey	Displays when trying to create a MyKey with a key already designated as a MyKey.
Key restricted at next start. Label this key	Displays to confirm that the key is restricted after you switch the ignition off.

## **MyKey – Frequently Asked Questions - Vehicles Without: Push Button Start**

### **What is an admin key?**

- An admin key is a key that has not been created as a MyKey. See **Creating a MyKey** (page 69).

### **Why can I not create a MyKey?**

- The key used to switch the ignition on is not an admin key.
- The key used to switch the ignition on is the only admin key. There always has to be at least one admin key.

### **Why can I not program a MyKey?**

- The key used to switch the ignition on is not an admin key.
- No MyKeys are created. See **Creating a MyKey** (page 69).

### **Why can I not clear the MyKeys?**

- The key used to switch the ignition on is not an admin key.
- No MyKeys are created. See **Creating a MyKey** (page 69).

### **Why does the MyKey distance not accumulate?**

- The key used to start the engine is an admin key.
- No MyKeys are created. See **Creating a MyKey** (page 69).
- The MyKeys have been cleared.

## **MyKey – Frequently Asked Questions - Vehicles With: Keyless Entry/Push Button Start**

### **What is an admin key?**

- An admin key is a key that has not been created as a MyKey. See **Creating a MyKey** (page 70).

### **Why can I not create a MyKey?**

- The admin key is not placed in the backup position. See **Creating a MyKey** (page 70).
- The key used to switch the ignition on is not an admin key.
- The key used to switch the ignition on is the only admin key. There always has to be at least one admin key.
- The last MyKey was created without switching the ignition off.

### **Why can I not program a MyKey?**

- The admin key is not inside your vehicle.
- The key used to switch the ignition on is not an admin key.
- No MyKeys are created. See **Creating a MyKey** (page 70).

### **Why can I not clear the MyKeys?**

- The admin key is not inside your vehicle.
- The key used to switch the ignition on is not an admin key.
- No MyKeys are created. See **Creating a MyKey** (page 70).

## **Why does the MyKey distance not accumulate?**

- The key used to start the engine is an admin key.
- An admin key and a MyKey are inside your vehicle.
- No MyKeys are created. See **Creating a MyKey** (page 70).
- The MyKeys have been cleared.

## **Why can I not start the engine with a MyKey?**

- An admin key and a MyKey are inside your vehicle.

# Doors and Locks

## OPERATING THE DOORS FROM OUTSIDE YOUR VEHICLE

### Unlocking and Locking the Doors Using the Remote Control

You can only use the remote control when your vehicle is stationary.

### Unlocking the Doors



Press the button to unlock all doors.

### Locking the Doors



Press the button to lock all doors. One short flash of the turn signal lamps confirms that your vehicle has locked.

**Note:** For more information on operating the doors from outside your vehicle See *Keyless Entry* (page 83).

### Unlocking and Locking the Doors Using the Key Blade

#### Removing the Lock Cylinder Cap

1. Release the key blade from the remote control. See **Removing the Key Blade** (page 63).

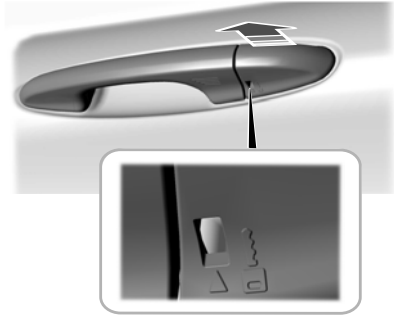

E243949

2. Fully insert the key blade into the key slot.
3. Gently pull the lock cylinder cap toward you to release it.
4. Insert the key blade into the lock cylinder.

### Locking the Doors

Turn the top of the key toward the front of your vehicle.

### Unlocking the Driver Door

Turn the top of the key toward the rear of your vehicle.

**Note:** If the child safety locks are on and you pull the interior handle, you only switch off the emergency locking, not the child safety lock. You can only open the doors using the external door handle.



# Doors and Locks

## Reinstalling the Lock Cylinder Cap

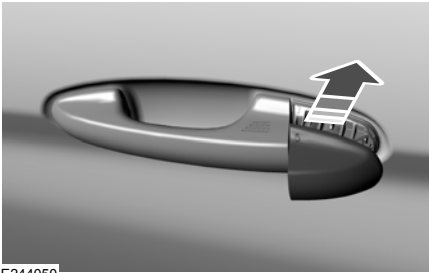

E244050

1. Place the cap over the lock cylinder.
2. Push the cap forward until it clicks into place. Make sure you have properly installed the cap by trying to move it rearward.

## Double Locking the Doors Using the Remote Control



**WARNING:** Do not use double locking when passengers or animals are inside your vehicle. The doors cannot be unlocked or opened from the inside when double locked.

Double locking is a theft protection feature that prevents someone from opening the doors from the inside. You can only double lock the doors if all the doors are closed.



Press the button twice within three seconds. Three short flashes of the direction indicators confirm that your vehicle has double locked.

## Double Locking the Doors Using the Key Blade



**WARNING:** Do not use double locking when passengers or animals are inside your vehicle. The doors cannot be unlocked or opened from the inside when double locked.

Double locking is a theft protection feature that prevents someone from opening the doors from the inside. You can only double lock the doors if all the doors are closed.

1. Remove the lock cylinder cap. See **Unlocking and Locking the Doors Using the Key Blade** (page 76).
2. Turn the top of the key toward the front of your vehicle twice within three seconds.
3. Reinstall the lock cylinder cap.

# Doors and Locks

## Individually Unlocking and Locking the Doors Using the Key Blade

### Locking the Doors

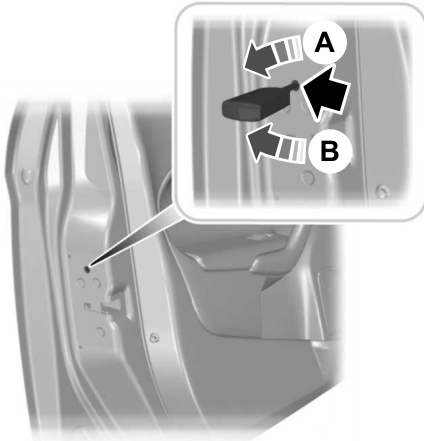

If the central locking function does not operate, individually lock the doors using the key in the position shown.

#### Left-Hand Side

Turn counterclockwise to lock.

#### Right-Hand Side

Turn clockwise to lock.

### Unlocking the Doors

If the central locking function does not operate, unlock the driver door and then individually unlock all other doors by pulling the interior door handles.

**Note:** *When the doors have been unlocked using this method, the doors must be individually locked until the central locking function has been repaired.*

## OPERATING THE DOORS FROM INSIDE YOUR VEHICLE

### Unlocking and Locking the Doors Using the Central Locking

The power door lock control is on the driver door.



Press the button to unlock all doors.



Press the button to lock all doors.

**Note:** *The central locking only operates if the front doors are fully closed.*

## REPROGRAMMING THE UNLOCKING FUNCTION - VEHICLES WITH: 4.2 INCH INSTRUMENT CLUSTER DISPLAY SCREEN

You can program the unlocking function so that only the driver door unlocks.

Press and hold the unlock and lock buttons on the remote control simultaneously for at least four seconds with the ignition off. The direction indicators flash twice to confirm the change.

To return to the original unlocking function, repeat the process.

# Doors and Locks

---

If you program the unlocking function so that only the driver door unlocks, the following occurs:

- If you unlock the driver door first, all other doors remain locked. You can unlock all of the other doors from inside your vehicle using the power door lock control on the driver door. Doors can be individually unlocked by pulling the interior door handles on those doors.
- If you press the unlocking button on the remote control once, only the driver door unlocks. Press the unlocking button on the remote control twice within three seconds to unlock all doors.
- If you unlock any other door first, all other doors and the liftgate unlock.

You can also change between the unlocking modes in the information display.

1. Using the information display controls on the steering wheel, select **Settings**.
2. Select **Vehicle settings**.
3. Select **Locks**.
4. Select **Unlocking**.
5. Select **All doors** or **Driver's door**.

## REPROGRAMMING THE UNLOCKING FUNCTION - VEHICLES WITH: 12.3 INCH INSTRUMENT CLUSTER DISPLAY SCREEN

You can program the unlocking function so that only the driver door unlocks.

Press and hold the unlock and lock buttons on the remote control simultaneously for at least four seconds with the ignition off. The direction indicators flash twice to confirm the change.

To return to the original unlocking function, repeat the process.

If you program the unlocking function so that only the driver door unlocks, the following occurs:

- If you unlock the driver door first, all other doors remain locked. You can unlock all of the other doors from inside your vehicle using the power door lock control on the driver door. Doors can be individually unlocked by pulling the interior door handles on those doors.
- If you press the unlocking button on the remote control once, only the driver door unlocks. Press the unlocking button on the remote control twice within three seconds to unlock all doors.
- If you unlock any other door first, all other doors and the liftgate unlock.

You can also change between the unlocking modes in the information display.

1. Press the menu button on the steering wheel to enter the information display main menu.
2. Select **Settings**.
3. Select **Vehicle**.
4. Select **Locks**.
5. Select **Unlocking**.
6. Select **All doors** or **Driver's door**.

## DOOR LOCK SWITCH INHIBITOR

### How Does the Door Lock Switch Inhibitor Work

The door lock switch inhibitor is a theft protection feature that prevents someone unlocking the vehicle from inside using the power door lock control switch.

# Doors and Locks

---

When you lock your vehicle with the remote control, the power door lock control switch does no longer operate after 20 seconds.

**Note:** *You must unlock your vehicle with the remote control, or switch the ignition on, to restore the power door lock control switch function.*

## AUTOUNLOCK

### What Is Autounlock

Autounlock is an unlocking feature that unlocks the vehicle doors when your vehicle comes to a stop.

### Autounlock Requirements

Autounlock unlocks all the doors when all of the following occur:

- The ignition is on, all the doors are closed and your vehicle is moving at a speed greater than 20 km/h (12 mph).
- Your vehicle comes to a stop.
- You open the driver door within 10 minutes of switching the ignition off or to the accessory position.

### Switching Autounlock On and Off - Vehicles With: 4.2 Inch Instrument Cluster Display Screen

1. Using the information display controls on the steering wheel, select **Settings**.
2. Select **Vehicle settings**.
3. Select **Locks**.
4. Switch **Auto unlock** on or off.

### Switching Autounlock On and Off - Vehicles With: 12.3 Inch Instrument Cluster Display Screen

1. Press the menu button on the steering wheel to enter the information display main menu.
2. Select **Settings**.
3. Select **Vehicle**.
4. Select **Locks**.
5. Switch **Auto unlock** on or off.

## MISLOCK

### What Is Mislock

Mislock is a locking feature that warns you if your vehicle has not locked.

### How Does Mislock Work

The horn sounds when you press the lock button on the remote control twice within three seconds and a door is open.

### Mislock Limitations - Vehicles Without: Anti-Theft Alarm

When you press the lock button once, the direction indicators do not flash if any door or the liftgate is open.

If you switch mislock off, the horn does not sound if you press the lock button on the remote control when a door is open.

### Mislock Limitations - Vehicles With: Anti-Theft Alarm

When you press the lock button once, the direction indicators do not flash if:

- Any door or the liftgate is open.
- The hood is open.

# Doors and Locks

---

If you switch mislock off, the horn does not sound if you press the lock button on the remote control when a door is open.

## Switching Mislock On and Off - Vehicles With: 4.2 Inch Instrument Cluster Display Screen

1. Using the information display controls on the steering wheel, select **Settings**.
2. Select **Vehicle settings**.
3. Select **Locks**.
4. Switch **Mislock chirp** on or off.

## Switching Mislock On and Off - Vehicles With: 12.3 Inch Instrument Cluster Display Screen

1. Press the menu button on the steering wheel to enter the information display main menu.
2. Select **Settings**.
3. Select **Vehicle**.
4. Select **Locks**.
5. Switch **Mislock chirp** on or off.

## AUTORELOCK

### How Does Autorelock Work

The doors automatically relock if you do not open a door within 45 seconds of unlocking the doors with the remote control. The door locks and the alarm return to their previous state.

## DOOR LOCK INDICATORS

An LED on the power door lock control illuminates when you lock the door. It remains on for up to five minutes after you switch the ignition off.

## DOORS AND LOCKS AUDIBLE WARNINGS

### Door Ajar Audible Warning

Sounds when a door is not fully closed and your vehicle is moving.

## DOORS AND LOCKS – TROUBLESHOOTING

### Doors and Locks – Warning Lamps

#### Door Ajar Warning Lamp



It illuminates when you switch the ignition on and remains on if any door or the hood is open.

# Doors and Locks

---

## Doors and Locks – Information Messages

<b>Message</b>	<b>Action</b>
Driver door open	Displays if a door is open. Fully close the door.
Passenger door open	
Rear left door open	
Rear right door open	

# Keyless Entry

## KEYLESS ENTRY LIMITATIONS

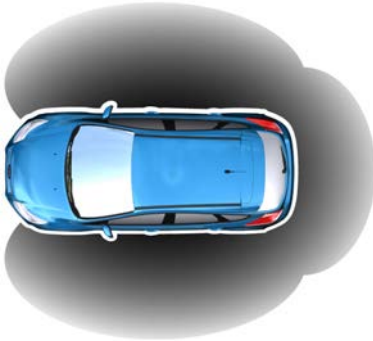

E78276

A valid passive key must be within one of the three external detection ranges. These are approximately 1.5 m (5 ft) from the front door handles and the liftgate.

The system could not function if:

- The passive key remains stationary for about a minute.
- The vehicle battery has no charge.
- The passive key battery has no charge.
- The passive key frequencies are jammed.
- The passive key is too close to metal objects or electronic devices, for example keys or a cell phone.

## KEYLESS ENTRY SETTINGS

### Switching Keyless Entry On and Off - Vehicles With: 4.2 Inch Instrument Cluster Display Screen

1. Using the information display controls on the steering wheel, select **Settings**.
2. Select **Vehicle settings**.
3. Select **Locks**.

4. Switch **KeyFree** on and off.

### Switching Keyless Entry On and Off - Vehicles With: 12.3 Inch Instrument Cluster Display Screen

1. Press the menu button on the steering wheel to enter the information display main menu.
2. Select **Settings**.
3. Select **Vehicle**.
4. Select **Locks**.
5. Select **KeyFree**.
6. Press and hold the **OK** button until a confirmation message appears in the information display.

### Reprogramming the Unlocking Function - Vehicles With: 4.2 Inch Instrument Cluster Display Screen

You can program the unlocking function so that only the driver door unlocks when you touch the unlock sensor on the exterior door handle.

If you program the unlocking function so that only the driver door unlocks, the following occurs:

- If you open the driver door first, all other doors remain locked. You can unlock all of the other doors from inside your vehicle using the power door lock control on the driver door. You can unlock individual doors by pulling the interior door handles on those doors.
- If you open any other door first, all other doors and the liftgate unlock.

You can change between the unlocking modes in the information display.

1. Using the information display controls on the steering wheel, select **Settings**.
2. Select **Vehicle settings**.
3. Select **Locks**.

# Keyless Entry

4. Select **Unlocking**.
5. Select **All doors** or **Driver's door**.

## Reprogramming the Unlocking Function - Vehicles With 12.3 Inch Instrument Cluster Display Screen

You can program the unlocking function so that only the driver door unlocks when you touch the unlock sensor on the exterior door handle.

If you program the unlocking function so that only the driver door unlocks, the following occurs:

- If you open the driver door first, all other doors remain locked. You can unlock all of the other doors from inside your vehicle using the power door lock control on the driver door. You can unlock individual doors by pulling the interior door handles on those doors.
- If you open any other door first, all other doors and the liftgate unlock.

You can change between the unlocking modes in the information display.

1. Press the menu button on the steering wheel to enter the information display main menu.
2. Select **Settings**.
3. Select **Vehicle**.
4. Select **Locks**.
5. Select **Unlocking**.
6. Select **All doors** or **Driver's door**.

## LOCKING AND UNLOCKING THE DOORS USING KEYLESS ENTRY

### Unlocking the Doors

Unlock sensors are on the back of the exterior front door handles.

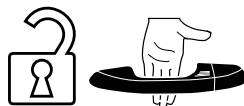

Touch the unlock sensor to unlock your vehicle and disarm the alarm. The direction indicators flash. Do not touch the lock sensor on the top of the door handle.

Keep the door handle clean to make sure the system correctly operates.

After unlocking the doors with the unlock sensor, there is a brief delay before you can lock your vehicle. When the delay period is over, you can lock the doors again, provided the passive key is within the respective detection range.

### Locking the Doors

Lock sensors are on the top of the exterior front door handles.



Touch a lock sensor once to lock your vehicle and arm the alarm. The direction indicators flash.

Keep the door handle clean to make sure the system correctly operates.

**Note:** *Your vehicle does not automatically lock. If you do not touch a lock sensor your vehicle remains unlocked.*



# Keyless Entry

After locking the doors with the lock sensor, there is a brief delay before you can unlock your vehicle. This delay lets you pull the handle to make sure your vehicle is locked. When the delay period is over, you can unlock the doors again, provided the passive key is within the respective detection range.

## Double Locking the Doors

Touch a lock sensor twice within three seconds to double lock your vehicle and arm the alarm. The direction indicators flash. Do not touch the unlock sensor on the back of the door handle.

## LOCKING AND UNLOCKING THE LIFTGATE USING KEYLESS ENTRY

### Unlocking the Liftgate

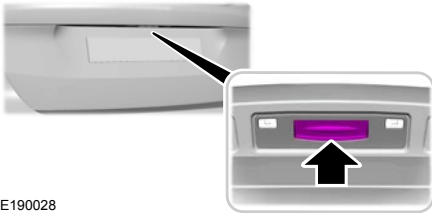

E190028

Press the exterior release button hidden above the license plate.

**Note:** A valid passive key must be within the detection range.

### Locking the Liftgate

The liftgate locks after you fully close it.

## KEYLESS ENTRY – TROUBLESHOOTING

### Keyless Entry – Frequently Asked Questions

#### Why does the keyless entry system not function?

If the system does not function it may be limited. See **Keyless Entry Limitations** (page 83). If the system still does not function use the remote control or the key blade to lock and unlock your vehicle.

#### Why can I not lock my vehicle?

If you electronically lock your vehicle with a rear door or the liftgate open, the system searches for a passive key inside your vehicle after you close the last door. If the system detects a key, all doors unlock indicating that a key is inside. Your vehicle locks if another passive key is within the detection range after you close the last door.

#### Why does the passive key not work?

The system deactivates passive keys left inside your vehicle when you lock it. You cannot switch the ignition on using a deactivated passive key. Press the unlock button on the remote control to reactivate a passive key.

# Liftgate

## MANUAL LIFTGATE



**WARNING:** It is extremely dangerous to ride in a cargo area, inside or outside of a vehicle. In a crash, people riding in these areas are more likely to be seriously injured or killed. Do not allow people to ride in any area of your vehicle that is not equipped with seats and seatbelts. Make sure everyone in your vehicle is in a seat and properly using a seatbelt. Failure to follow this warning could result in serious personal injury or death.

**Note:** Be careful when opening or closing the liftgate in a garage or other enclosed area to avoid damaging the liftgate.

**Note:** Do not hang anything, for example a bike rack, from the glass or liftgate. This could damage the liftgate and its components.

**Note:** Do not leave the liftgate open when you are driving. This could damage the liftgate and its components.

## Opening the Liftgate Using the Exterior Release Button

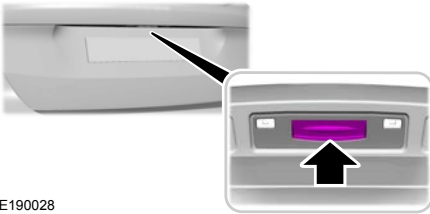

E190028

## Liftgate Ajar Information Messages

Message	Description and Action
Liftgate open	Displays if the liftgate is open. Fully close the liftgate.

Press the exterior release button.

## Opening the Liftgate Using the Remote Control



Press the button twice within three seconds.

## Closing the Liftgate



**WARNING:** Make sure that you fully close the liftgate to prevent exhaust fumes from entering your vehicle. If you are unable to fully close the liftgate, open the air vents or the windows to allow fresh air to enter your vehicle. Failure to follow this instruction could result in personal injury or death.



**WARNING:** Make sure that you fully close the liftgate to prevent passengers and cargo from falling out. Failure to follow this instruction could result in personal injury or death.

A recessed grip or handle is inside the liftgate to help with closing.

## Liftgate Ajar Warning Lamp



A warning illuminates in the instrument cluster when you switch the ignition on, or if the liftgate is open.

# Liftgate

## POWER LIFTGATE



**WARNING:** It is extremely dangerous to ride in a cargo area, inside or outside of a vehicle. In a crash, people riding in these areas are more likely to be seriously injured or killed. Do not allow people to ride in any area of your vehicle that is not equipped with seats and seatbelts. Make sure everyone in your vehicle is in a seat and properly using a seatbelt. Failure to follow this warning could result in serious personal injury or death.



**WARNING:** Keep keys out of reach of children. Do not allow children to operate or play near an open or moving power liftgate. You should supervise the operation of the power liftgate at all times.



**WARNING:** Make sure all persons are clear of the power liftgate area before using the power liftgate control.

Make sure the area behind your vehicle is free from obstruction and that there is enough room for you to operate the liftgate. The liftgate could come into contact with objects that are too close to your vehicle, for example a wall, garage door or another vehicle. This could damage the liftgate and its components.

For vehicles with automatic transmission, the liftgate only operates with the transmission in park (P).

A tone sounds when you attempt to open the liftgate if:

- The ignition is on and the transmission is not in park (P).
- The vehicle battery charge is low.

- The liftgate is not fully closed and your vehicle speed is more than 4 km/h (2 mph).
- The system detects an obstacle.
- The system has malfunctioned.

If the liftgate starts to close after it has fully opened, this indicates there could be excessive weight on the liftgate or a possible strut failure. A repetitive tone sounds and the liftgate closes under control. If the liftgate continues to close after opening, have the system checked as soon as possible.

**Note:** *The liftgate movement stops for a short period of time if you try to open it when it is closing under control.*

**Note:** *Do not hang anything, for example a bike rack, from the glass or liftgate. This could damage the liftgate and its components.*

### Opening the Liftgate

Allow the system to open the liftgate. Do not manually push or pull the liftgate when it is moving. This could damage the liftgate and its components.

Do not leave the liftgate open when you are driving. This could damage the liftgate and its components.

### Opening the Liftgate From Outside Your Vehicle

1. Unlock the liftgate with the remote control or power door unlock control. If a passive key is within 1 m (3 ft) of the liftgate, the liftgate unlocks when you press the liftgate release button.

# Liftgate

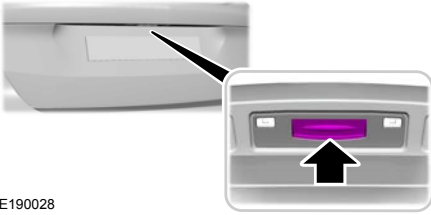

E190028

2. Press the exterior release button.

## Opening the Liftgate From Inside Your Vehicle



Press the button next to the lighting control.

## Opening the Liftgate With the Remote Control



Press the button twice within three seconds.

## Closing the Liftgate



**WARNING:** Make sure that you fully close the liftgate to prevent exhaust fumes from entering your vehicle. If you are unable to fully close the liftgate, open the air vents or the windows to allow fresh air to enter your vehicle. Failure to follow this instruction could result in personal injury or death.



**WARNING:** Make sure that you fully close the liftgate to prevent passengers and cargo from falling out. Failure to follow this instruction could result in personal injury or death.



**WARNING:** Keep clear of the liftgate when using the rear switch.

Make sure that you fully close the liftgate before operating or moving your vehicle, especially in an enclosure, for example a garage or a parking structure.

## Closing the Liftgate From Outside Your Vehicle



E265451

- Press the button.

## Closing the Liftgate From Inside Your Vehicle



Press the button next to the lighting control. A tone sounds when the liftgate begins to close.

## Closing the Liftgate With the Remote Control



Press the button twice within three seconds. A tone sounds when the liftgate begins to close.

## Setting the Liftgate Open Height

1. Open the liftgate.



E265451

2. Press the button to stop the liftgate when it reaches the required height.

# Liftgate

**Note:** When the liftgate stops moving, you can manually move it to the required height.

- Press and hold the button until a tone sounds, indicating programming is complete.

**Note:** You cannot program the height if the liftgate height is too low or too high.

The liftgate opens to the new programmed height the next time you open the liftgate. To change the programmed height again, repeat the above procedure.

**Note:** If you disconnect the vehicle battery, the system recalls the new programmed height after you reconnect it.

## Stopping the Liftgate Movement

You can stop the liftgate movement by doing any of the following:

- Pressing the liftgate control button.
- Pressing the liftgate button on the remote control twice.

- Pressing the liftgate button on the instrument panel.
- Moving your foot, in a single-kick motion, without pausing, under and away from the rear bumper detection area.

\*Vehicles with a hands-free liftgate.

Do not manually push or pull the liftgate when it is moving. This could damage the liftgate and its components.

## Obstacle Detection

### Closing the Liftgate

The system stops when it detects an obstacle. A tone sounds and the liftgate could reverse to open. After you remove the obstacle, you can continue to operate the liftgate.

### Opening the Liftgate

The system stops when it detects an obstacle and a tone sounds. After you remove the obstacle, you can continue to operate the liftgate.

## Switching the Power Liftgate On or Off

To switch the power liftgate on or off, use the information display controls on the steering wheel to select the following:

Menu Item	Action
Settings	Press the menu button.
Vehicle settings	Press the <b>OK</b> button.
Power liftgate	Press the <b>OK</b> button.

## Liftgate Ajar Warning Lamp



A warning illuminates in the instrument cluster when you switch the ignition on or if the liftgate is open.

# Liftgate

## Liftgate Ajar Information Messages

Message	Action
Liftgate open	Displays if the liftgate is open. Fully close the liftgate.

## HANDS-FREE POWER LIFTGATE



**WARNING:** It is extremely dangerous to ride in a cargo area, inside or outside of a vehicle. In a crash, people riding in these areas are more likely to be seriously injured or killed. Do not allow people to ride in any area of your vehicle that is not equipped with seats and seatbelts. Make sure everyone in your vehicle is in a seat and properly using a seatbelt. Failure to follow this warning could result in serious personal injury or death.



**WARNING:** Make sure that you fully close the liftgate to prevent exhaust fumes from entering your vehicle. If you are unable to fully close the liftgate, open the air vents or the windows to allow fresh air to enter your vehicle. Failure to follow this instruction could result in personal injury or death.



**WARNING:** Make sure that you fully close the liftgate to prevent passengers and cargo from falling out. Failure to follow this instruction could result in personal injury or death.



**WARNING:** Keep keys out of reach of children. Do not allow children to operate or play near an open or moving power liftgate. You should supervise the operation of the power liftgate at all times.

Make sure the area behind your vehicle is free from obstruction and that there is enough room for you to operate the liftgate. The liftgate could come into contact with objects that are too close to your vehicle, for example a wall, garage door or another vehicle. This could damage the liftgate and its components.

For vehicles with automatic transmission, the liftgate only operates with the transmission in park (P).

**Note:** Do not hang anything, for example a bike rack, from the glass or liftgate.

Make sure you have a passive key within 1 m (3 ft) of the liftgate.

1. Stand behind your vehicle, and face the liftgate. Do not stand too close to your vehicle or the sensors may not detect the motion.



E253664

2. Move your foot in a single-kick motion, without pausing, under and away from the rear bumper detection area. The detection area is in the center of the rear bumper.
3. The liftgate power opens or closes.

# Liftgate

Allow the system to open the liftgate. Do not manually push or pull the liftgate when it is moving. This could damage the liftgate and its components.

Do not leave the liftgate open when you are driving. This could damage the liftgate and its components.

Avoid the following actions when using the hands-free opening feature:

- Making physical contact with the bumper.
- Holding your foot under the bumper for longer than a few seconds.
- Sweeping your foot from side to side, or kicking at an odd angle.

**Note:** *Splashing water may cause the hands-free liftgate to open. Keep the passive key away from the rear bumper detection area when you wash your vehicle.*

Make sure that you fully close the liftgate before operating or moving your vehicle, especially in an enclosure, for example a garage or a parking structure.

## Liftgate Ajar Warning Lamp



A warning illuminates in the instrument cluster when you switch the ignition on, or if the liftgate is open.

## Liftgate Ajar Information Messages

Message	Action
Liftgate open	Displays if the liftgate is open. Fully close the liftgate.

# Security

---

## PASSIVE ANTI-THEFT SYSTEM

### What Is the Passive Anti-Theft System

The passive anti-theft system prevents someone from starting the vehicle with an incorrectly coded key.

**Note:** *The system is not compatible with non-Ford aftermarket remote start systems.*

**Note:** *Do not leave a duplicate coded key in your vehicle. Always take the keys and lock all doors when leaving your vehicle.*

### Arming the Passive Anti-Theft System

The passive anti-theft system arms your vehicle after a short period of time when you switch the power off.

### Disarming the Passive Anti-Theft System

The passive anti-theft system disarms when you switch the power on with a correctly coded key.

**Note:** *You could have difficulty starting the vehicle if you have metallic objects, electronic devices or a second coded key on the same key chain.*

## ANTI-THEFT ALARM SYSTEM

### What Is the Anti-Theft Alarm System

The Anti-Theft Alarm System warns you of an unauthorized entry to your vehicle.

### How Does the Anti-Theft Alarm System Work

When armed, the anti-theft alarm is triggered in any of the following ways:

- If someone opens a door, the liftgate or the hood without a correctly coded key or remote control.
- If you turn the power on without a correctly coded key.
- If the interior sensors detect movement inside your vehicle.
- If the inclination sensors detect an attempt to raise your vehicle.
- If someone disconnects the vehicle battery or the battery backup alarm.

If the anti-theft alarm is triggered, the alarm horn sounds for 30 seconds and the direction indicators flash for 5 minutes.

Any further attempts to carry out one of the above sounds the alarm again.

### What Is the Perimeter Alarm

The perimeter alarm is designed to detect unauthorized access to your vehicle.

### What Are the Interior Sensors

The interior sensors are designed to detect any movement inside your vehicle.

The interior sensors are in the overhead console.

**Note:** *Do not cover the interior sensors.*

### What Are the Inclination Sensors

The inclination sensor is designed to detect an attempt to raise your vehicle, for example to remove a wheel or to tow it away.



# Security

## What Is the Battery Backup Alarm

The battery backup alarm is an additional alarm system that has its own battery and horn. It is designed to detect if the vehicle battery or the battery backup alarm is disconnected.

## Arming the Anti-Theft Alarm System

The alarm is ready to arm when there is not a key in your vehicle.

Lock your vehicle with your remote control to arm the alarm.

## Disarming the Anti-Theft Alarm System

Disarm the alarm by performing any of the following actions:

- Unlock the doors or luggage compartment with the remote control.
- Switch your vehicle on or start your vehicle.

## Setting the Alarm Security Level

**To set the alarm security level to full guard or reduced guard, use the information display controls on the steering wheel to select the following:**

Menu Item	Action
Settings	Press the menu button.
Vehicle settings	Press the <b>OK</b> button.
Alarm system	Press the <b>OK</b> button.
Alarm settings	Press the <b>OK</b> button.
Full guard	Press the toggle button upward or downward to choose your required setting. Press the <b>OK</b> button.
Reduced guard	

## ANTI-THEFT ALARM SYSTEM SETTINGS

### What are the Alarm Security Levels

You can select two levels of alarm security, full guard and reduced guard.

#### Full Guard

Full guard is the standard setting.

In full guard, all equipped sensors are on when you arm the alarm.

**Note:** Do not arm the alarm with full guard if passengers, animals or other moving objects are inside your vehicle.

#### Reduced Guard

In reduced guard, only the perimeter sensors are on when you arm the alarm.

**Note:** The alarm security level will switch back to full guard once the power is turned on.

# Security

## What Is Ask on Exit

You can choose which level of security you require after you switch the ignition off.

**After you switch the ignition off, use the information display controls on the steering wheel to select the following:**

Menu Item	Action
Full guard	Press the toggle button upward or downward to choose your required setting. Press the <b>OK</b> button.
Reduced guard	

**Note:** *If you do not choose a setting, the system defaults to full guard.*

## Switching Ask on Exit On and Off

1. Press **Settings** on the touchscreen.
2. Press **Vehicle settings**.
3. Press **Alarm System**.
4. Switch **Ask on Exit** on or off.

## SECURITY – TROUBLESHOOTING

### Security – Information Messages

Message	Action
No key detected	The system has not detected a correctly coded key.
Starting system malfunction	The system has malfunctioned. Have your vehicle checked as soon as possible.
Vehicle alarm Start vehicle to stop alarm	Displays when the alarm has been triggered due to unauthorized entry.
Alarm announcement	

# Security

---

## **Security – Frequently Asked Questions**

### **What should I do if there is any potential alarm problem with my vehicle?**

Take all remote controls to an authorized dealer if there is any potential alarm problem with your vehicle.

### **What should I do if the vehicle is unable to start with a correctly coded key?**

Have your vehicle checked as soon as possible.

# Door Edge Protection

---

## PRINCIPLE OF OPERATION

The front and rear doors have a retractable plastic door edge protector that moves into position when you open a door. The door edge protector protects the door edge from damage that could be caused by contact with other objects.

Do not attempt to move the door edge protector if it becomes stuck, or does not move freely. Have your vehicle checked as soon as possible.

**Note:** *The door edge protector may be moved gently out of position when the door is open to allow access for cleaning. Make sure that the door edge protector is repositioned correctly otherwise it may not retract when you attempt to close the door.*

**Note:** *Keep the door edges free from snow, ice and large accumulations of dirt.*

# Steering Wheel

## ADJUSTING THE STEERING WHEEL

**WARNING:** Do not adjust the steering wheel when your vehicle is moving.

**Note:** Make sure that you are sitting in the correct position. See **Sitting in the Correct Position** (page 177).



E95178

1. Unlock the steering column.
2. Adjust the steering wheel to the desired position.



E95179

3. Lock the steering column.

## LOCKING THE STEERING WHEEL - VEHICLES WITHOUT: PUSH BUTTON START

1. Remove the key from the ignition.
2. Slightly rotate the steering wheel to engage the lock.

## Unlocking the Steering Wheel

**WARNING:** Always check that the steering is unlocked before attempting to move your vehicle.

1. Insert the key in the ignition.
2. Turn the key to position **I**.

**Note:** You may have to slightly rotate the steering wheel to assist unlocking it.

# Steering Wheel

---

## LOCKING THE STEERING WHEEL - VEHICLES WITH: KEYLESS ENTRY/PUSH BUTTON START

The steering wheel lock locks shortly after you have parked your vehicle and the passive key is outside it.

**Note:** *The steering wheel lock does not lock when the ignition is on or when your vehicle is moving.*

### Unlocking the Steering Wheel

The steering wheel lock unlocks when the system detects a valid passive key inside your vehicle. If the steering wheel lock relocks, switch the ignition on to unlock it.

**Note:** *You may have to slightly rotate the steering wheel to assist unlocking it.*

## HEATED STEERING WHEEL

The heated steering wheel button is on the climate controls.



Press the button to switch the heated steering wheel on and off.

**Note:** *You can use the heated steering wheel only when the engine is running.*

**Note:** *The system uses a sensor and is designed to control the temperature of the steering wheel and to prevent it from overheating.*

**Note:** *In warm temperatures, the steering wheel quickly reaches its maximum temperature and the system reduces the current to the heating element. This could cause you to think that the system has stopped working but it has not. This is normal.*

# Wipers and Washers

## WINDSHIELD WIPERS

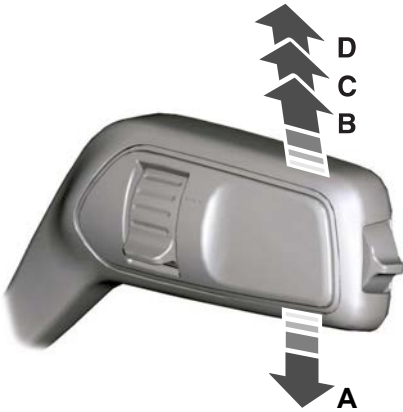

E248785

- A Single wipe.
- B Intermittent wipe.
- C Normal wipe.
- D High-speed wipe.

**Note:** Fully defrost the windshield before you switch the windshield wipers on.

**Note:** Make sure that you switch the windshield wipers off before entering a car wash.

**Note:** If streaks or smears appear on the windshield, clean the windshield and the wiper blades. See **Checking the Wiper Blades** (page 430). If that does not resolve the issue, install new wiper blades. See **Changing the Front Wiper Blades** (page 430).

**Note:** Do not operate the wipers on a dry windshield. This may scratch the glass or damage the wiper blades. Always use the windshield washers before wiping a dry windshield.

## Intermittent Wipe

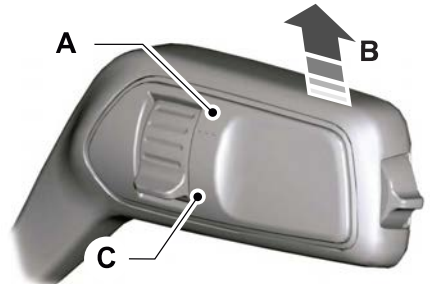

E242320

- A Short wipe interval.
- B Intermittent wipe.
- C Long wipe interval.

Use the rotary control to adjust the intermittent wipe interval.

**Note:** When your vehicle speed increases, the interval between intermittent wipes may decrease.

## AUTOWIPERS - VEHICLES WITH: 4.2 INCH INSTRUMENT CLUSTER DISPLAY SCREEN (IF EQUIPPED)

Autowipers uses a rain sensor in the area around the interior mirror. The wipers operate when the rain sensor detects water on the windshield in front of it. The rain sensor continues to monitor the amount of water and adjusts the speed of the wipers.

You can switch autowipers on or off in the information display.

**Note:** If you switch autowipers off in the information display, the windshield wipers operate in intermittent mode.

# Wipers and Washers

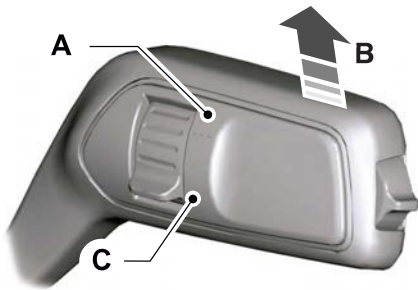

E242320

- A High sensitivity.
- B Autowipers on.
- C Low sensitivity.

Move the wiper lever upward to the first position to switch autowipers on.

Use the rotary control to adjust the sensitivity of the autowipers. When you select low sensitivity, the wipers operate when the sensor detects a large amount of water on the windshield. When you select high sensitivity, the wipers operate when the sensor detects a small amount of water on the windshield.

**Note:** Keep the outside of the windshield clean. The rain sensor is very sensitive and the wipers may operate if dirt, mist or insects hit the windshield.

## Settings

**To switch autowipers on or off, use the information display controls on the steering wheel to select the following:**

Menu Item	Action
Settings	Press the menu button.
Vehicle settings	Press the <b>OK</b> button.
Wipers	Press the <b>OK</b> button.
Rain sensing	Press the <b>OK</b> button.

If you leave autowipers on, it may not operate when you switch the ignition on during freezing temperatures. This is because the system has deactivated the rain sensor to prevent damage to the windshield wipers. Defrost the windshield before reactivating the rain sensor. You can reactivate the rain sensor by moving the rotary control or switching autowipers off and on.

**Note:** Fully defrost the windshield before you switch the windshield wipers on.

**Note:** Make sure that you switch the windshield wipers off before entering a car wash.

Wet or winter weather conditions could cause unexpected wiping or smearing.

To keep the windshield clear:

- Lower the sensitivity of the autowipers to reduce the amount of smearing on the windshield.
- Switch autowipers off.

**Note:** If streaks or smears appear on the windshield, clean the windshield and the wiper blades. See **Checking the Wiper Blades** (page 430). If that does not resolve the issue, install new wiper blades. See **Changing the Front Wiper Blades** (page 430).



# Wipers and Washers

## **AUTOWIPERS - VEHICLES WITH: 12.3 INCH INSTRUMENT CLUSTER DISPLAY SCREEN (IF**

**EQUIPPED)**

Autowipers uses a rain sensor in the area around the interior mirror. The wipers operate when the rain sensor detects water on the windshield in front of it. The rain sensor continues to monitor the amount of water and adjusts the speed of the wipers.

You can switch autowipers on or off in the information display.

**Note:** *If you switch autowipers off in the information display, the windshield wipers operate in intermittent mode.*

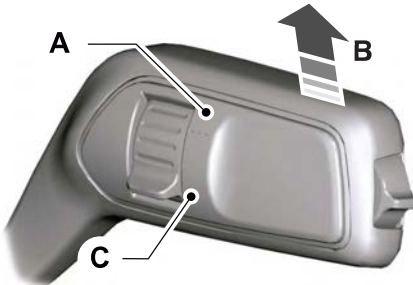

E242320

- A High sensitivity.
- B Autowipers on.
- C Low sensitivity.

Move the wiper lever upward to the first position to switch autowipers on.

Use the rotary control to adjust the sensitivity of the autowipers. When you select low sensitivity, the wipers operate when the sensor detects a large amount of water on the windshield. When you select high sensitivity, the wipers operate when the sensor detects a small amount of water on the windshield.

**Note:** *Keep the outside of the windshield clean. The rain sensor is very sensitive and the wipers may operate if dirt, mist or insects hit the windshield.*

If you leave autowipers on, it may not operate when you switch the ignition on during freezing temperatures. This is because the system has deactivated the rain sensor to prevent damage to the windshield wipers. Defrost the windshield before reactivating the rain sensor. You can reactivate the rain sensor by moving the rotary control or switching autowipers off and on.

**Note:** *Fully defrost the windshield before you switch the windshield wipers on.*

**Note:** *Make sure that you switch the windshield wipers off before entering a car wash.*

Wet or winter weather conditions could cause unexpected wiping or smearing.

To keep the windshield clear:

- Lower the sensitivity of the autowipers to reduce the amount of smearing on the windshield.
- Switch autowipers off.

**Note:** *If streaks or smears appear on the windshield, clean the windshield and the wiper blades. See **Checking the Wiper Blades** (page 430). If that does not resolve the issue, install new wiper blades. See **Changing the Front Wiper Blades** (page 430).*

# Wipers and Washers

## Autowiper Settings

1. Press the menu button on the steering wheel to enter the information display main menu.
2. Select **Settings**.
3. Select **Vehicle**.
4. Select **Wipers**.
5. Switch **Rain sensing** on or off.

## WINDSHIELD WASHERS - VEHICLES WITH: 4.2 INCH INSTRUMENT CLUSTER DISPLAY SCREEN



E242323

## Settings

**To switch courtesy wipe on or off, use the information display controls on the steering wheel to select the following:**

Menu Item	Action
Settings	Press the menu button.
Vehicle settings	Press the <b>OK</b> button.
Wipers	Press the <b>OK</b> button.
Courtesy wipe	Press the <b>OK</b> button.

Pull the lever toward you to operate the windshield washers. When you release the lever, the wipers operate for a short time. A courtesy wipe occurs a short time after the wipers stop to clear any remaining washer fluid.

You can switch courtesy wipe on or off in the information display.

**Note:** *Do not operate the washers when the washer reservoir is empty. This could cause the washer pump to overheat.*

# Wipers and Washers

## WINDSHIELD WASHERS - VEHICLES WITH: 12.3 INCH INSTRUMENT CLUSTER DISPLAY SCREEN



E242323

Pull the lever toward you to operate the windshield washers. When you release the lever, the wipers operate for a short time. A courtesy wipe occurs a short time after the wipers stop to clear any remaining washer fluid.

You can switch courtesy wipe on or off in the information display.

**Note:** Do not operate the washers when the washer reservoir is empty. This could cause the washer pump to overheat.

### Switching the Courtesy Wipe On and Off

1. Press the menu button on the steering wheel to enter the information display main menu.
2. Select **Settings**.
3. Select **Vehicle**.

4. Select **Wipers**.
5. Switch **Courtesy wipe** on or off.

## REAR WINDOW WIPER AND WASHERS - VEHICLES WITH: 4.2 INCH INSTRUMENT CLUSTER DISPLAY SCREEN (IF EQUIPPED)

### Rear Window Wiper

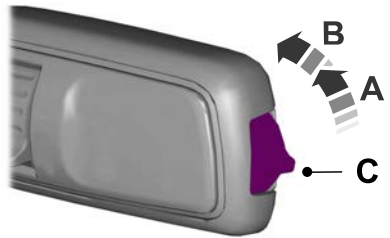

- A Intermittent wipe.
- B Continuous wipe.
- C Rear window wiper off.

The rear window wiper also turns on when you shift into reverse and the windshield wipers are on.

You can switch reverse wipe off in the information display.

**Note:** Make sure that you switch the rear window wiper off before entering a car wash.

# Wipers and Washers

## Settings

To switch reverse wipe on or off, use the information display controls on the steering wheel to select the following:

Menu Item	Action
Settings	Press the menu button.
Vehicle settings	Press the <b>OK</b> button.
Wipers	Press the <b>OK</b> button.
Reverse wiper	Press the <b>OK</b> button.

## Rear Window Washer



E242432

Push the lever away from you to operate the rear window washer. When you release the lever, the wiper operates for a short time.

**Note:** Do not operate the washers when the washer reservoir is empty. This could cause the washer pump to overheat.

## REAR WINDOW WIPER AND WASHERS - VEHICLES WITH: 12.3 INCH INSTRUMENT CLUSTER DISPLAY SCREEN (IF EQUIPPED)

### Rear Window Wiper

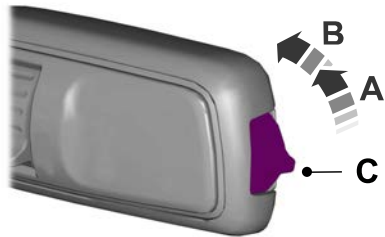

- A Intermittent wipe.
- B Continuous wipe.
- C Rear window wiper off.

The rear window wiper also turns on when you shift into reverse and the windshield wipers are on.

You can switch reverse wipe off in the information display.

# Wipers and Washers

---

**Note:** Make sure that you switch the rear window wiper off before entering a car wash.

## Switching Reverse Wipe On and Off

1. Press the menu button on the steering wheel to enter the information display main menu.
2. Select **Settings**.
3. Select **Vehicle**.
4. Select **Wipers**.
5. Switch **Reverse wiper** on or off.

## Rear Window Washer



Push the lever away from you to operate the rear window washer. When you release the lever, the wiper operates for a short time.

**Note:** Do not operate the washers when the washer reservoir is empty. This could cause the washer pump to overheat.

## HEADLAMP WASHERS (IF EQUIPPED)

If you operate the windshield washers when the headlamps are on, the headlamp washers turn on.

**Note:** The headlamp washers do not operate every time you use the windshield washers. This is to prevent the washer fluid reservoir from emptying quickly.

# Lighting

## GENERAL INFORMATION

### Condensation in the Exterior Front Lamps and Rear Lamps

Exterior front lamps and rear lamps have vents to accommodate normal changes in air pressure.

Condensation can be a natural by-product of this design. When moist air enters the lamp assembly through the vents, there is a possibility that condensation can occur when the temperature is cold. When normal condensation occurs, a fine mist can form on the interior of the lens. The fine mist eventually clears and exits through the vents during normal operation.

Clearing time may take as long as 48 hours under dry weather conditions.

Examples of acceptable condensation are:

- The presence of a fine mist (no streaks, drip marks or large droplets).
- A fine mist covers less than 50% of the lens.

Examples of unacceptable condensation are:

- A water puddle inside the lamp.
- Streaks, drip marks or large droplets present on the interior of the lens.

If you see any unacceptable condensation, have your vehicle checked by an authorized dealer.

## LIGHTING CONTROL

### Lighting Control Positions

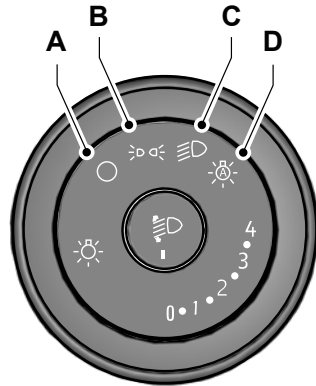

- A Lamps off.
- B Parking lamps, instrument panel lamps and license plate lamps.
- C Headlamps.
- D Autolamps. See **Autolamps** (page 108).

### Switching All of the Parking Lamps On

1. Switch the ignition off.
2. Set the lighting control to the parking lamps position.

**Note:** *Parking lamps could turn off to prevent the vehicle battery from running out of charge.*

### Switching the Left-Hand Side or the Right-Hand Side Parking Lamps On (If Equipped)

1. Switch the ignition off.

# Lighting



2. Push the lever up or down to switch the parking lamps on.

**Note:** Parking lamps could turn off to prevent the vehicle battery from running out of charge.

## Switching High Beam Headlamps On and Off



Push the lever away from you to switch the high beam headlamps on.

Push the lever forward again or pull the lever toward you to switch the high beam headlamps off.

**Note:** If you switch the autolamps on, you cannot switch the high beam headlamps on until the system turns the headlamps on.

## Flashing High Beam Headlamps



E248604

Pull the lever toward you and release it to flash the high beam headlamps.

## High Beam Headlamp Indicator



It illuminates when you switch the high beam headlamps on.

## Lamps On Indicator



It illuminates when you switch the low beam headlamps or the side and rear lamps on.

## Low Beam Headlamp Warning Lamp (If Equipped)



If it illuminates when the low beam headlamps are on, this indicates that a low beam headlamp bulb has failed.

## Exterior Lamps On Audible Warning

Sounds when you open the driver door and the exterior lamps are on.

# Lighting

## Headlamps Information Messages

Message	Description
Check adaptive headlamps See manual	Displays if an electrical malfunction occurs with the headlamp system. Have your vehicle checked as soon as possible.

## AUTOLAMPS - VEHICLES WITH: 4.2 INCH INSTRUMENT CLUSTER DISPLAY SCREEN



**WARNING:** The system does not relieve you of your responsibility to drive with due care and attention. You may need to override the system if it does not turn the headlamps on in low visibility conditions, for example daytime fog.

Autolamps turn the headlamps on in low light situations or when the wipers operate.

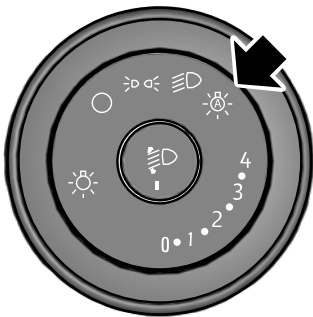

**Note:** When you switch the autolamps on, the headlamps turn on within 10 seconds of switching the wipers on.

**Note:** If you switch the autolamps and the autowipers on, the headlamps turn on when the windshield wipers continuously operate.

**Note:** The headlamps turn off approximately 60 seconds after you switch the wipers off.

The headlamps remain on for a period of time after you switch the ignition off. Use the information display controls to adjust the period of time that the headlamps remain on.

## Adjusting the Period of Time That the Headlamps Remain On

1. Using the information display controls on the steering wheel, select **Settings**.
2. Select **Vehicle settings**.
3. Select **Lighting**.
4. Select **Headlamp delay**.
5. Select a setting.
6. Press the **OK** button.

## AUTOLAMPS - VEHICLES WITH: 12.3 INCH INSTRUMENT CLUSTER DISPLAY SCREEN



**WARNING:** The system does not relieve you of your responsibility to drive with due care and attention. You may need to override the system if it does not turn the headlamps on in low visibility conditions, for example daytime fog.

Autolamps turn the headlamps on in low light situations or when the wipers operate.



# Lighting

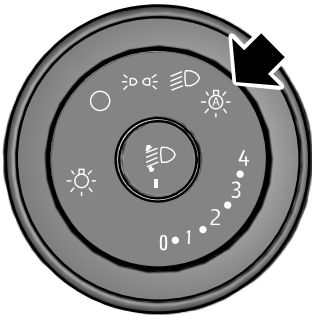

**Note:** When you switch the autolamps on, the headlamps turn on within 10 seconds of switching the wipers on.

**Note:** If you switch the autolamps and the autowipers on, the headlamps turn on when the windshield wipers continuously operate.

**Note:** The headlamps turn off approximately 60 seconds after you switch the wipers off.

The headlamps remain on for a period of time after you switch the ignition off. Use the information display controls to adjust the period of time that the headlamps remain on.

## Adjusting the Period of Time That the Headlamps Remain On

1. Press the menu button on the steering wheel to enter the information display main menu.
2. Select **Settings**.
3. Select **Vehicle**.
4. Select **Lighting**.
5. Select **Headlamp delay**.
6. Select a setting and press the **OK** button.

## INSTRUMENT LIGHTING DIMMER

The instrument lighting dimmer buttons are on the lighting control.



Repeatedly press one of the buttons to adjust the brightness.



## HEADLAMP EXIT DELAY

After you switch the ignition off, you can switch the headlamps on by pulling the direction indicator lever toward you. You will hear a short tone. The headlamps will switch off automatically after three minutes with any door open or 30 seconds after the last door has been closed. You can cancel this feature by pulling the direction indicator lever toward you again or switching the ignition on.

## AUTOMATIC HIGH BEAM CONTROL - VEHICLES WITH: 4.2 INCH INSTRUMENT CLUSTER DISPLAY SCREEN



**WARNING:** The system does not relieve you of your responsibility to drive with due care and attention. You may need to override the system if it does not turn the high beams on or off.



**WARNING:** You may need to override the system when approaching other road users.



**WARNING:** You may need to override the system during inclement weather.

# Lighting



**WARNING:** Do not use the system in poor visibility, for example fog, heavy rain, spray or snow.



**WARNING:** The system may not switch the high beams off if the lights of oncoming vehicles are hidden by obstacles, for example guard rails.



**WARNING:** Inspect and replace the windshield wiper blades regularly to make sure the camera sensor has a clear view. The windshield wiper blades must be the correct length.

- The ambient light level is low enough that high beams are required.
- There is no traffic in front of your vehicle.
- Your vehicle speed is greater than approximately 40 km/h (25 mph).

The system is designed to turn the high beams off if any of the following occur:

- You switch the system off in the information display.
- You set the lighting control to any position except autolamps.
- You switch the rear fog lamps on.
- The ambient light level is high enough that high beams are not required.
- The system detects an approaching vehicle's headlamps or rear lamps.
- The system detects severe rain, snow or fog.
- The system detects street lighting.
- The camera has reduced visibility.
- Your vehicle speed falls below approximately 30 km/h (19 mph).

## About Automatic High Beam Control

The system is designed to turn the high beams on if all of the following occur:

- You switched the system on in the information display.
- You set the lighting control to the autolamps position.

## Switching Automatic High Beam Control On or Off

To switch the system on or off, use the information display controls on the steering wheel to select the following:

Menu Item	Action
Settings	Press the menu button.
Vehicle settings	Press the <b>OK</b> button.
Lighting	Press the <b>OK</b> button.
Auto highbeam	Press the <b>OK</b> button.

## Automatic High Beam Indicator



It illuminates to confirm when the system is ready to assist.

## Overriding Automatic High Beam Control

Push the lever away from you to switch between high beam and low beam.

# Lighting

## Automatic High Beam Control Information Messages

Message	Description
Front camera Low visibility Clean screen	The camera has reduced visibility. Clean the windshield. If the message continues to appear, have your vehicle checked as soon as possible.
Front camera temporarily not available	The camera has malfunctioned. Wait a short period of time for the camera to cool down. If the message continues to appear, have your vehicle checked as soon as possible.

### AUTOMATIC HIGH BEAM CONTROL - VEHICLES WITH: 12.3 INCH INSTRUMENT CLUSTER DISPLAY SCREEN



**WARNING:** The system does not relieve you of your responsibility to drive with due care and attention. You may need to override the system if it does not turn the high beams on or off.



**WARNING:** You may need to override the system when approaching other road users.



**WARNING:** You may need to override the system during inclement weather.



**WARNING:** Do not use the system in poor visibility, for example fog, heavy rain, spray or snow.



**WARNING:** The system may not switch the high beams off if the lights of oncoming vehicles are hidden by obstacles, for example guard rails.



**WARNING:** Inspect and replace the windshield wiper blades regularly to make sure the camera sensor has a clear view. The windshield wiper blades must be the correct length.

### About Automatic High Beam Control

The system is designed to turn the high beams on if all of the following occur:

- You switch the system on in the information display.
- You set the lighting control to the autolamps position.
- The ambient light level is low enough that high beams are required.
- There is no traffic in front of your vehicle.
- Your vehicle speed is greater than approximately 40 km/h (25 mph).

The system is designed to turn the high beams off if any of the following occur:

- You switch the system off in the information display.
- You set the lighting control to any position except autolamps.
- You switch the rear fog lamps on.
- The ambient light level is high enough that high beams are not required.

# Lighting

- The system detects an approaching vehicle's headlamps or rear lamps.
- The system detects severe rain, snow or fog.
- The system detects street lighting.
- The camera has reduced visibility.
- Your vehicle speed falls below approximately 30 km/h (19 mph).

## Switching Automatic High Beam Control On or Off

1. Press the menu button on the steering wheel to enter the information display main menu.

2. Select **Settings**.
3. Select **Vehicle**.
4. Select **Lighting**.
5. Switch **Auto highbeam** on or off.

## Automatic High Beam Indicator



It illuminates to confirm when the system is ready to assist.

## Overriding Automatic High Beam Control

Push the lever away from you to switch between high beam and low beam.

## Automatic High Beam Control Information Messages

Message	Description
Front camera Low visibility Clean screen	The camera has reduced visibility. Clean the windshield. If the message continues to appear, have your vehicle checked as soon as possible.
Front camera temporarily not available	The camera has malfunctioned. Wait a short period of time for the camera to cool down. If the message continues to appear, have your vehicle checked as soon as possible.
Front camera malfunction Service required	The camera has malfunctioned. Have your vehicle checked as soon as possible.

## GLARE-FREE HIGH BEAM - VEHICLES WITH: 4.2 INCH INSTRUMENT CLUSTER DISPLAY SCREEN



**WARNING:** The system does not relieve you of your responsibility to drive with due care and attention. You may need to override the system if it does not turn the high beams on or off.



**WARNING:** You may need to override the system when approaching other road users.



**WARNING:** You may need to override the system during inclement weather.



**WARNING:** Do not use the system in poor visibility, for example fog, heavy rain, spray or snow.

# Lighting



**WARNING:** The system may not adapt the high beams to avoid glare if the lights of oncoming vehicles are hidden by obstacles, for example guard rails.



**WARNING:** Inspect and replace the windshield wiper blades regularly to make sure the camera sensor has a clear view. The windshield wiper blades must be the correct length.

## About Glare-Free High Beam

The system is designed to prevent you from distracting other road users when the high beams are on.

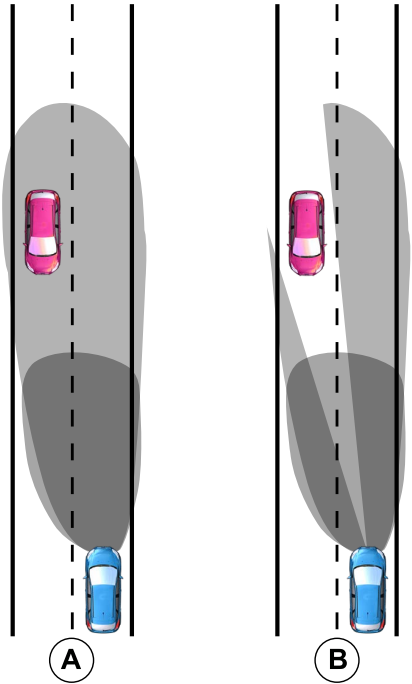

- A Normal High Beam.  
B Glare-Free High Beam.

The system is designed to turn the high beams on if all of the following occur:

- You switched the system on in the information display.
- You set the lighting control to the autolamps position.
- The ambient light level is low enough that high beams are required.
- Your vehicle speed is greater than approximately 40 km/h (25 mph).

# Lighting

The system is designed to adapt the high beams to avoid glare if all of the following occur:

- You switched the system on in the information display.
- You set the lighting control to the autolamps position.
- The system detects an approaching vehicle's headlamps or rear lamps.



The high beam headlamp indicator remains on when the system adapts the high beams to avoid glare.

The system is designed to turn the high beams off if any of the following occur:

- You switch the system off in the information display.
- You set the lighting control to any position except autolamps.
- You switch the rear fog lamps on.
- The system detects severe rain, snow or fog.
- The system detects street lighting.
- The camera has reduced visibility.
- Your vehicle speed falls below approximately 30 km/h (19 mph).

## Switching Glare-Free High Beam On or Off

To switch the system on or off, use the information display controls on the steering wheel to select the following:

Menu Item	Action
Settings	Press the menu button.
Vehicle settings	Press the <b>OK</b> button.
Lighting	Press the <b>OK</b> button.
Glarefree lighting	Press the <b>OK</b> button.

## Glare-Free High Beam Indicator



It illuminates to confirm when the system is ready to assist.

## Overriding Glare-Free High Beam

Push the lever away from you to switch between high beam and low beam.

## Glare-Free High Beam Information Messages

Message	Description
Front camera Low visibility Clean screen	The camera has reduced visibility. Clean the windshield. If the message continues to appear, have your vehicle checked as soon as possible.
Front camera temporarily not available	The camera has malfunctioned. Wait a short period of time for the camera to cool down. If the message continues to appear, have your vehicle checked as soon as possible.

# Lighting

## GLARE-FREE HIGH BEAM - VEHICLES WITH: 12.3 INCH INSTRUMENT CLUSTER DISPLAY SCREEN

**WARNING:** The system does not relieve you of your responsibility to drive with due care and attention. You may need to override the system if it does not turn the high beams on or off.

**WARNING:** You may need to override the system when approaching other road users.

**WARNING:** You may need to override the system during inclement weather.

**WARNING:** Do not use the system in poor visibility, for example fog, heavy rain, spray or snow.

**WARNING:** The system may not adapt the high beams to avoid glare if the lights of oncoming vehicles are hidden by obstacles, for example guard rails.

**WARNING:** Inspect and replace the windshield wiper blades regularly to make sure the camera sensor has a clear view. The windshield wiper blades must be the correct length.

### About Glare-Free High Beam

The system is designed to prevent you from distracting other road users when the high beams are on.

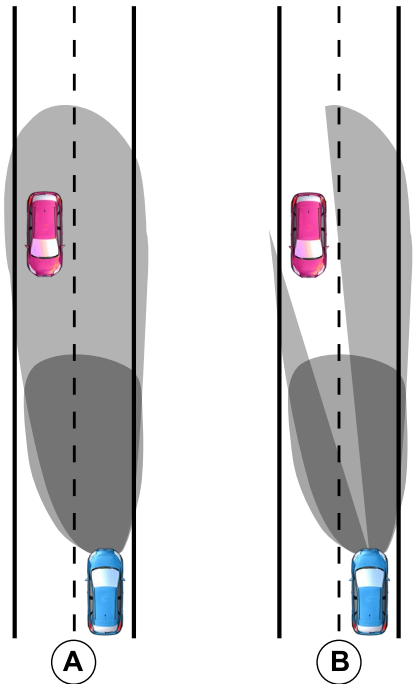

- A Normal High Beam.
- B Glare-Free High Beam.

The system is designed to turn the high beams on if all of the following occur:

- You switch the system on in the information display.
- You set the lighting control to the autolamps position.
- The ambient light level is low enough that high beams are required.
- Your vehicle speed is greater than approximately 40 km/h (25 mph).

# Lighting

The system is designed to adapt the high beams to avoid glare if all of the following occur:

- You switch the system on in the information display.
- You set the lighting control to the autolamps position.
- The system detects an approaching vehicle's headlamps or rear lamps.



The high beam headlamp indicator remains on when the system adapts the high beams to avoid glare.

The system is designed to turn the high beams off if any of the following occur:

- You switch the system off in the information display.
- You set the lighting control to any position except autolamps.
- You switch the rear fog lamps on.
- The system detects severe rain, snow or fog.
- The system detects street lighting.

## Glare-Free High Beam Information Messages

Message	Description
Front camera Low visibility Clean screen	The camera has reduced visibility. Clean the windshield. If the message continues to appear, have your vehicle checked as soon as possible.
Front camera temporarily not available	The camera has malfunctioned. Wait a short period of time for the camera to cool down. If the message continues to appear, have your vehicle checked as soon as possible.
Front camera malfunction Service required	The camera has malfunctioned. Have your vehicle checked as soon as possible.

- The camera has reduced visibility.
- Your vehicle speed falls below approximately 30 km/h (19 mph).

## Switching Glare-Free High Beam On or Off

1. Press the menu button on the steering wheel to enter the information display main menu.
2. Select **Settings**.
3. Select **Vehicle**.
4. Select **Lighting**.
5. Switch **Glarefree lighting** on or off.

## Glare-Free High Beam Indicator



It illuminates to confirm when the system is ready to assist.

## Overriding Glare-Free High Beam

Push the lever away from you to switch between high beam and low beam.



# Lighting

## FRONT FOG LAMPS

### Switching the Front Fog Lamps On or Off

Only switch the front fog lamps on during reduced visibility.

You can switch the front fog lamps on if any of the following occur:

- You set the lighting control to the parking lamps position.
- You set the lighting control to the headlamps position.
- You set the lighting control to the autolamps position and the headlamps are on.

The front fog lamp button is on the lighting control.



Press the button to switch the front fog lamps on or off.

**Note:** *The brightness of the daytime running lamps may decrease when the front fog lamps are switched on.*

### Front Fog Lamp Indicator



It illuminates when you switch the front fog lamps on.

## REAR FOG LAMPS

### Switching the Rear Fog Lamps On or Off



**WARNING:** Do not use the rear fog lamps when it is raining or snowing and visibility is more than 50 m (164.0 ft).

You can switch the rear fog lamps on if any of the following occur:

- You switched the front fog lamps on.
- You set the lighting control to the headlamps position.
- You set the lighting control to the autolamps position and the headlamps are on.

The rear fog lamp button is on the lighting control.



Press the button to switch the rear fog lamps on or off.

### Rear Fog Lamp Indicator



It illuminates when you switch the rear fog lamps on.

## HEADLAMP LEVELING

To adjust the level of the headlamp beams, do the following:



E132711

1. Press to release the control.

# Lighting

2. Rotate the control in accordance with your vehicle load to prevent you from distracting other road users when the headlamps are on.

**Note:** Set the control to zero when your vehicle is unloaded.

**Note:** Set the headlamp beams to give between 35–100 m (115–328 ft) of road surface illumination when your vehicle is partially or fully loaded.

3. Press to close the control.

## ADAPTIVE HEADLAMPS - VEHICLES WITH: 4.2 INCH INSTRUMENT CLUSTER DISPLAY SCREEN

The headlamps are designed to adapt when you are steering around a curve, or if the camera detects lane markings indicating a curve or traffic signs indicating an intersection or a roundabout.

**Note:** Set the lighting control to the autolamps position to use the adaptive headlamps.

## Steering Around a Curve

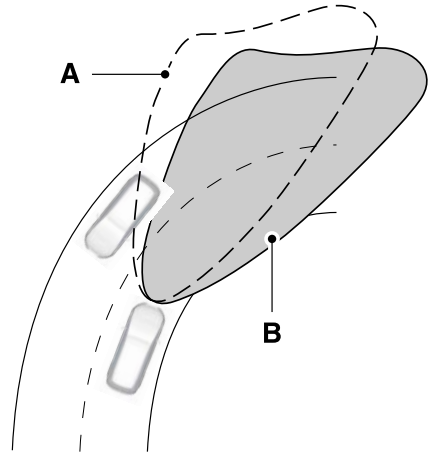

- A Without adaptive headlamps.
- B With adaptive headlamps.

## Camera Detects Lane Markings

You can switch the feature off in the information display.

# Lighting

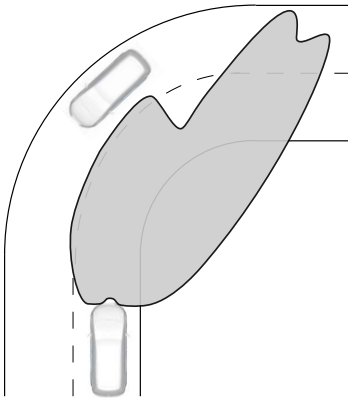

E267903

## Camera Detects Traffic Signs

You can switch the feature off in the information display.

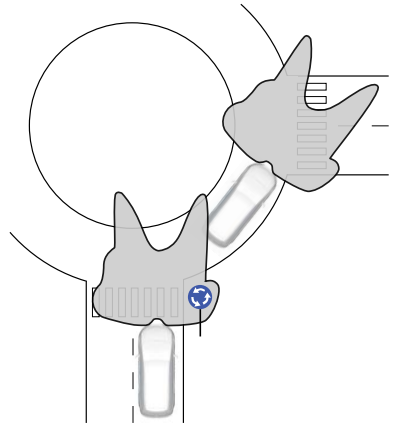

E266972

The camera only detects traffic signs if your vehicle speed is below 50 km/h (31 mph).

## Adaptive Headlamps Settings

To switch the camera detection off, use the information display controls on the steering wheel to select the following:

Menu Item	Action
Settings	Press the menu button.
Vehicle settings	Press the <b>OK</b> button.
Lighting	Press the <b>OK</b> button.
Predictive lighting	Press the <b>OK</b> button.

# Lighting

## Adaptive Headlamps Information Messages

Message	Description
Front camera Low visibility Clean screen	The camera has reduced visibility. Clean the windshield. If the message continues to appear, have your vehicle checked as soon as possible.
Front camera temporarily not available	The camera has malfunctioned. Wait a short period of time for the camera to cool down. If the message continues to appear, have your vehicle checked as soon as possible.

### ADAPTIVE HEADLAMPS - VEHICLES WITH: 12.3 INCH INSTRUMENT CLUSTER DISPLAY SCREEN

The headlamps are designed to adapt when you are steering around a curve, or if the camera detects lane markings indicating a curve or traffic signs indicating an intersection or a roundabout.

**Note:** Set the lighting control to the *autolamps* position to use the adaptive headlamps.

### Steering Around a Curve

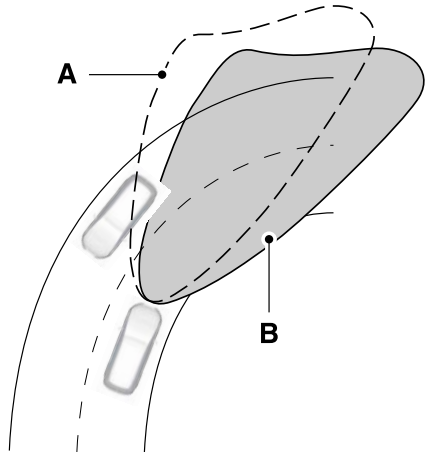

- A Without adaptive headlamps.
- B With adaptive headlamps.

# Lighting

## Camera Detects Lane Markings

You can switch the feature off in the information display.

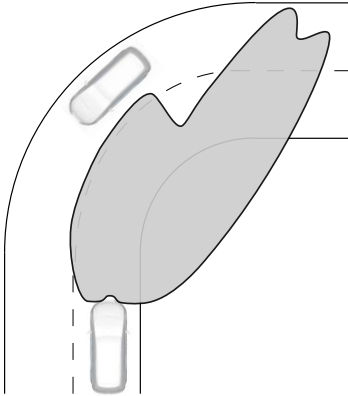

E267903

## Camera Detects Traffic Signs

You can switch the feature off in the information display.

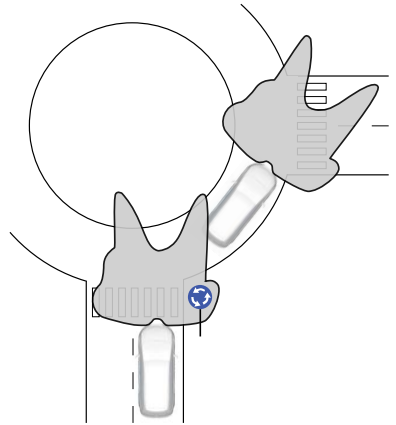

E266972

The camera only detects traffic signs if your vehicle speed is below 50 km/h (31 mph).

## Adaptive Headlamps Settings

1. Press the menu button on the steering wheel to enter the information display main menu.
2. Select **Settings**.
3. Select **Vehicle**.
4. Select **Lighting**.
5. Switch **Predictive lighting** on or off.

## Adaptive Headlamps Information Messages

Message	Description
Front camera Low visibility Clean screen	The camera has reduced visibility. Clean the windshield. If the message continues to appear, have your vehicle checked as soon as possible.
Front camera temporarily not available	The camera has malfunctioned. Wait a short period of time for the camera to cool down. If the message continues to appear, have your vehicle checked as soon as possible.

## CORNERING LAMPS

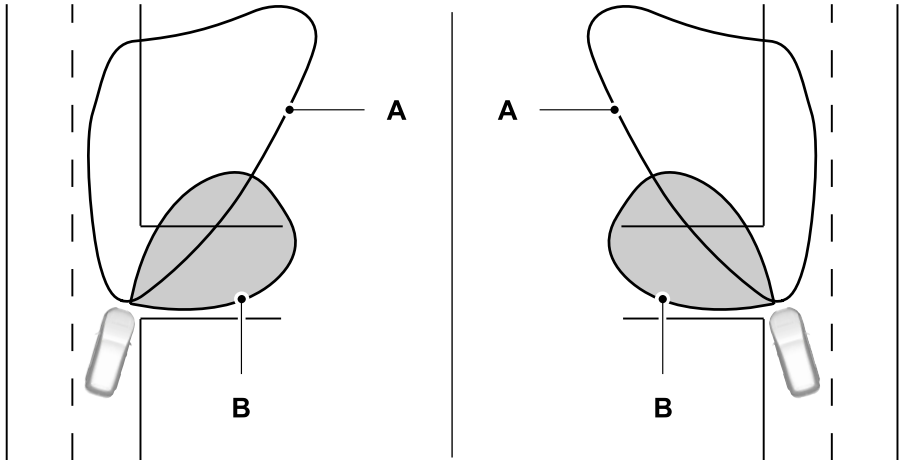

E72898

- A Headlamp beam.
- B Cornering lamp beam.

The cornering lamps illuminate the inside of a corner when you are turning the steering wheel.

## DIRECTION INDICATORS

### Switching the Direction Indicators On and Off



# Lighting

Push the lever up or down to switch the direction indicators on.

**Note:** Tap the lever up or down to make the direction indicators flash three times.

Set the lever to the middle position to switch the direction indicators off.

## Direction Indicator



Flashes when you switch the direction indicators on.

**Note:** An increase in the rate of flashing warns of a failed indicator bulb.

## INTERIOR LAMPS - VEHICLES WITHOUT: MAP READING LAMPS

### Switching All of the Interior Lamps On and Off

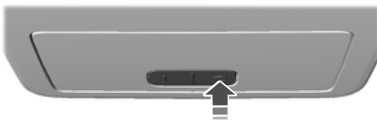
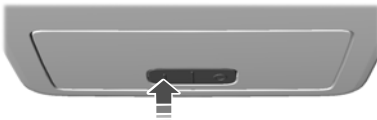

### Switching the Rear Interior Lamps On and Off

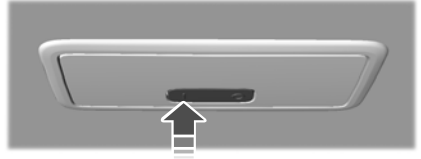

### Interior Lamp Function

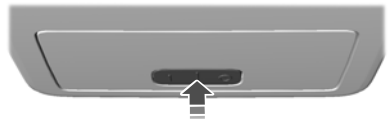

When you set the switch to the middle position, the interior lamps turn on if:

- You open a door.
- You press the unlock button on the remote control.
- You switch the ignition off.

**Note:** If you switch the ignition off, the interior lamps could turn off after a short time to prevent the vehicle battery from running out of charge.

# Lighting

## INTERIOR LAMPS - VEHICLES WITH: MAP READING LAMPS

### Switching All of the Interior Lamps On and Off

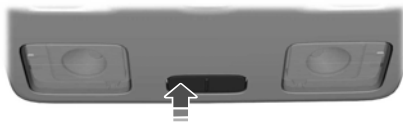

### Switching the Front Interior Lamps On and Off



E249791

**Note:** Press the edge of the lamps lens to switch the front interior lamp off before switching the ignition off to prevent the vehicle battery from running out of charge.

### Switching the Rear Interior Lamps On and Off

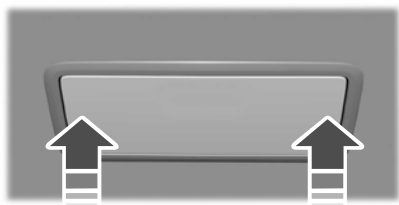

### Interior Lamp Function

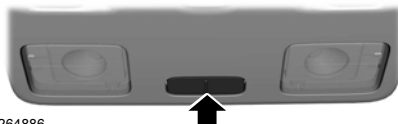

E264886

When you set the switch to the middle position, the interior lamps turn on if:

- You open a door.
- You press the unlock button on the remote control.
- You switch the ignition off.

**Note:** If you switch the ignition off, the interior lamps could turn off after a short time to prevent the vehicle battery from running out of charge.

## AMBIENT LIGHTING

The ambient lamps illuminate several areas, for example footwells and cup holders.

The ambient lamps illuminate in only one color.

### Switching the Ambient Lamps On

1. Switch the ignition on.

**Note:** You cannot permanently switch off the ambient light.



# Windows

## OPENING AND CLOSING THE WINDOWS



**WARNING:** Do not leave children unattended in your vehicle and do not let them play with the power windows. Failure to follow this instruction could result in personal injury.



**WARNING:** When closing the power windows, verify they are free of obstruction and make sure that children and pets are not in the proximity of the window openings.



Press the window control switch to open the window. Lift the window control switch to close the window.

**Note:** The power windows operate with the ignition on, and for several minutes after you switch the ignition off or until you open a front door.

To reduce wind noise or pulsing noise when one window is open, slightly open the opposite window.

### One-Touch Open

Fully press the window control switch and release it. Press again or lift it to stop the window.

### One-Touch Close

Fully lift the window control switch and release it. Press again or lift it to stop the window.

### Resetting One-Touch Close

Carry out all steps within 30 seconds of starting the sequence.

1. Close the window.

2. Press and hold the window control switch until the window is fully open. Keep the window control switch pressed for a few seconds.
3. Lift and hold the window control switch until the window is fully closed. Keep the window control switch held for a few seconds.
4. Press and hold the window control switch until the window is fully open. Keep the window control switch pressed for a few seconds.
5. Lift and hold the window control switch until the window is fully closed. Keep the window control switch held for a few seconds.

**Note:** Repeat the procedure if the window does not close when you use one-touch.

## GLOBAL OPENING AND CLOSING

### What Is Global Opening and Closing

You can use the remote control to operate the windows with the ignition off.

### Using Global Opening

1. Press and release the unlock button on the remote control.
2. Press and hold the unlock button on the remote control.
3. Release the button when the windows and moonroof start to open.

**Note:** The moonroof stops in the vent position.

Press the lock or the unlock button on the remote control to stop global opening.

**Note:** You can use global opening for a short period of time when you unlock your vehicle using the remote control.

# Windows

## Switching Global Opening On and Off - Vehicles With: 4.2 Inch Instrument Cluster Display Screen

1. Using the information display controls on the steering wheel, select **Settings**.
2. Select **Vehicle settings**.
3. Select **Windows**.
4. Switch **Global open** on or off.

## Switching Global Opening On and Off - Vehicles With: 12.3 Inch Instrument Cluster Display Screen

1. Press the menu button on the steering wheel to enter the information display main menu.
2. Select **Settings**.
3. Select **Vehicle**.
4. Select **Windows**.
5. Switch **Global open** on or off.

## Using Global Closing



**WARNING:** When closing the power windows, verify they are free of obstruction and make sure that children and pets are not in the proximity of the window openings.

1. Press and hold the lock button on the remote control.
2. Release the button when the windows and moonroof start to close.

Press the lock or the unlock button on the remote control to stop global closing.

**Note:** *Bounce-back is on during global closing. See **What Is Window Bounce-Back** (page 126).*

## Switching Global Closing On and Off - Vehicles With: 4.2 Inch Instrument Cluster Display Screen

1. Using the information display controls on the steering wheel, select **Settings**.
2. Select **Vehicle settings**.
3. Select **Windows**.
4. Switch **Global close** on or off.

## Switching Global Closing On and Off - Vehicles With: 12.3 Inch Instrument Cluster Display Screen

1. Press the menu button on the steering wheel to enter the information display main menu.
2. Select **Settings**.
3. Select **Vehicle**.
4. Select **Windows**.
5. Switch **Global close** on or off.

## WINDOW BOUNCE-BACK

### What Is Window Bounce-Back

The window stops and reverses if it detects an obstruction when closing.

### Overriding Window Bounce-Back



**WARNING:** If you override bounce-back, the window does not reverse if it detects an obstacle. Take care when closing the windows to avoid personal injury or damage to your vehicle.

1. Close the window until it reaches the point of resistance and let it reverse.

# Windows

2. Lift the control within five seconds to override bounce-back and close the window. Bounce-back is now disabled and you can close the window manually.

**Note:** *The window goes past the point of resistance and you can fully close it.*

**Note:** *If the window does not close, have your vehicle checked as soon as possible.*

## Resetting Window Bounce-Back



**WARNING:** Bounce-back is off until you reset the memory. Take care when closing the windows to avoid personal injury or damage to your vehicle.

If you have disconnected the battery, you must reset the bounce-back memory separately for each window.

Carry out all steps within 30 seconds of starting the sequence.

1. Close the window.
2. Press and hold the switch until the window is fully open. Keep the switch pressed for a few seconds.
3. Lift and hold the switch until the window is fully closed. Keep the switch held for a few seconds.
4. Press and hold the switch until the window is fully open. Keep the switch pressed for a few seconds.
5. Lift and hold the switch until the window is fully closed. Keep the switch held for a few seconds.

**Note:** *Repeat the procedure if the window does not close when you use one-touch.*

## LOCKING THE REAR WINDOW CONTROLS



Press the window control switch to lock or unlock the rear window controls. It illuminates when you lock the rear window controls.

# Interior Mirror

---

## ADJUSTING THE INTERIOR MIRROR



**WARNING:** Do not adjust the mirrors when your vehicle is moving. This could result in the loss of control of your vehicle, serious personal injury or death.

Pull the tab below the mirror toward you to reduce the effect of bright light from behind.

## AUTO-DIMMING INTERIOR MIRROR

### What Is the Auto-Dimming Interior Mirror

The mirror dims to reduce the effect of bright light from behind. It returns to normal when the bright light from behind is no longer present or if you shift into reverse (R).

### Auto-Dimming Interior Mirror Precautions



**WARNING:** Do not adjust the mirrors when your vehicle is moving. This could result in the loss of control of your vehicle, serious personal injury or death.

Do not block the sensors on the front and back of the mirror.

**Note:** *A rear center passenger or raised rear center head restraint could prevent light from reaching the sensor.*

# Exterior Mirrors

## ADJUSTING THE EXTERIOR MIRRORS



**WARNING:** Do not adjust the mirrors when your vehicle is moving. This could result in the loss of control of your vehicle, serious personal injury or death.

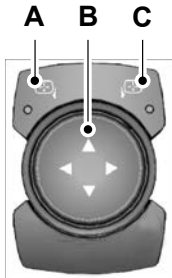

- A Left-hand mirror switch.
- B Mirror adjustment control.
- C Right-hand mirror switch.

## FOLDING THE EXTERIOR MIRRORS - VEHICLES WITH: 4.2 INCH INSTRUMENT CLUSTER DISPLAY SCREEN/ POWER FOLD EXTERIOR MIRRORS

The exterior mirrors fold when you lock your vehicle and unfold when you unlock your vehicle.



For tight parking conditions, press the control to fold the mirrors.

Press the control again to unfold the mirrors.

If you press the control to fold in the mirrors with auto-fold on, the mirrors do not unfold when you unlock your vehicle.

**Note:** *The power folding mirrors operate with the ignition on, and for several minutes after you switch the ignition off.*

**Note:** *If you fold and unfold the mirrors several times within one minute, the power fold function may turn off to protect the motors from overheating.*

## Switching Auto-fold On and Off

1. Using the information display controls on the steering wheel, select **Settings**.
2. Select **Vehicle settings**.
3. Select **Mirrors**.
4. Switch **Autofold** on or off.

## FOLDING THE EXTERIOR MIRRORS - VEHICLES WITH: 12.3 INCH INSTRUMENT CLUSTER DISPLAY SCREEN/ POWER FOLD EXTERIOR MIRRORS

The exterior mirrors fold when you lock your vehicle and unfold when you unlock your vehicle.



For tight parking conditions, press the control to fold the mirrors.

Press the control again to unfold the mirrors.

If you press the control to fold in the mirrors with auto-fold on, the mirrors do not unfold when you unlock your vehicle.

**Note:** *The power folding mirrors operate with the ignition on, and for several minutes after you switch the ignition off.*

# Exterior Mirrors

---

**Note:** *If you fold and unfold the mirrors several times within one minute, the power fold function may turn off to protect the motors from overheating.*

## Switching Auto-fold On and Off

1. Press the menu button on the steering wheel to enter the information display main menu.
2. Select **Settings**.
3. Select **Vehicle**.
4. Select **Mirrors**.
5. Switch **Auto fold** on or off.

## FOLDING THE EXTERIOR MIRRORS - VEHICLES WITH: MANUAL FOLD EXTERIOR MIRRORS

Push the mirror toward the door window glass.

Make sure that you fully engage the mirror in its support when returning it to its original position.

# Moonroof

## OPENING AND CLOSING THE SUN SHADE

### Opening the Sun Shades



**WARNING:** Do not leave children unattended in your vehicle and do not let them play with the sun shades. Failure to follow this instruction could result in personal injury.

The sun shade operates independently of the moonroof.

The sun shade controls are on the overhead console and have one-touch open.

To stop the motion during a one-touch operation, press the control a second time.



Press and release the rear of the control.

### Closing the Sun Shades



**WARNING:** When closing the sun shade, verify that it is free of obstruction and make sure that children and pets are not in the proximity of the sun shade.



**WARNING:** Do not leave children unattended in your vehicle and do not let them play with the sun shades. Failure to follow this instruction could result in personal injury.

The sun shade operates independently of the moonroof.

The sun shade controls are on the overhead console and have one-touch close.

To stop the motion during a one-touch operation, press the control a second time.



Press and release the front of the control.

## OPENING AND CLOSING THE MOONROOF

### Opening the Moonroof



**WARNING:** Do not leave children unattended in your vehicle and do not let them play with the moonroof. Failure to follow this instruction could result in personal injury.

The moonroof controls are on the overhead console and have one-touch open.

To stop the motion during a one-touch operation, press the control a second time.



Press and release the rear of the control to vent the moonroof.

Press and release the rear of the control again to open the moonroof.

### Closing the Moonroof



**WARNING:** When closing the moonroof, verify that it is free of obstruction and make sure that children and pets are not in the proximity of the roof opening.



**WARNING:** Do not leave children unattended in your vehicle and do not let them play with the moonroof. Failure to follow this instruction could result in personal injury.

The moonroof controls are on the overhead console and have one-touch close.

# Moonroof

---

To stop the motion during a one-touch operation, press the control a second time.



Press and release the front of the control.

## VENTING THE MOONROOF



**WARNING:** Do not leave children unattended in your vehicle and do not let them play with the moonroof. Failure to follow this instruction could result in personal injury.



Press and release the rear of the control to vent the moonroof.

Press and release the front of the control to close the moonroof.

## MOONROOF BOUNCE-BACK

The moonroof stops and reverses if it detects an obstruction.



Press and hold the front of the control within a few seconds to override bounce-back.



# Instrument Cluster - Vehicles With: 4.2 Inch Instrument Cluster Display Screen

## GAUGES - EXCLUDING: MILD HYBRID ELECTRIC VEHICLE (MHEV)/ST

### Instrument Cluster

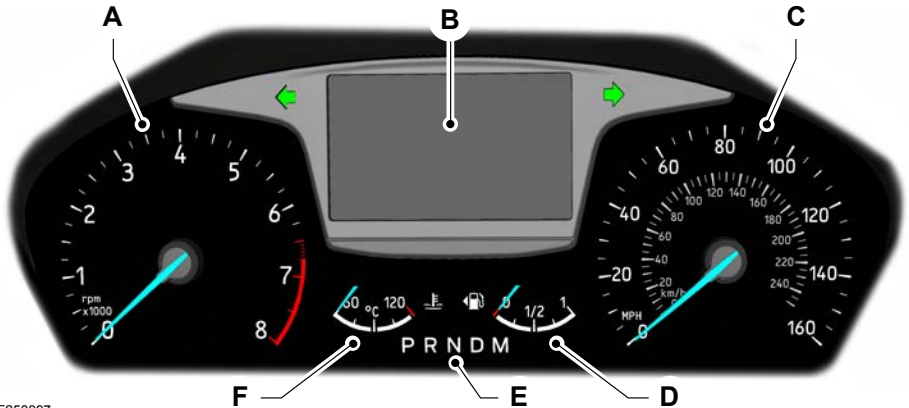

E258097

- A Tachometer.
- B Information display.
- C Speedometer.
- D Fuel gauge.
- E Automatic transmission position indicators.
- F Engine coolant temperature gauge.

### Tachometer

Shows the engine speed.

### Information Display

Shows the following information:

- Odometer.
- Trip computer.
- MyView information.
- Driver assistance information.

- Navigation information.
- Audio information.
- Phone information.
- Vehicle and system settings.
- Outside air temperature.
- Shift indicators.

### Odometer

Records the total distance traveled by your vehicle.

# Instrument Cluster - Vehicles With: 4.2 Inch Instrument Cluster Display Screen

The system detects unauthorized odometer adjustments to avoid total distance reading fraud. If the system detects an unauthorized odometer adjustment, the total distance reading displays XXXX. Recovery of the original mileage could result in system damage not covered by the vehicle Warranty and may carry a significant expense.

## Speedometer

Shows the vehicle speed.

## Fuel Gauge

The fuel gauge indicates approximately how much fuel is in the fuel tank.

The arrow adjacent to the fuel pump symbol indicates on which side of your vehicle the fuel filler door is located.



A



B

E236403

- A The fuel filler door is on the left-hand side of your vehicle.
- B The fuel filler door is on the right-hand side of your vehicle.

## Low Fuel Level Warning Lamp



If it illuminates when you are driving, refuel as soon as possible.

## Low Fuel Level Audible Warning

For MyKey users, a warning tone sounds and a message appears in the information display when the distance to empty reaches 120 km (75 mi).

For all keys, a warning tone sounds and a message appears in the information display when the distance to empty reaches 80 km (50 mi). A warning tone sounds and a message appears in the information display again at the following distance to empty parameters:

- 40 km (20 mi)
- 20 km (10 mi)
- 0 km (0 mi)

**Note:** *The low fuel reminder appears at different fuel gauge positions depending on fuel economy conditions. This variation is normal.*

## Engine Coolant Temperature Gauge

At normal operating temperature, the needle remains in the center section. If the needle enters the red section, the engine is overheating. Stop your vehicle as soon as it is safe to do so, switch the engine off and allow it to cool.

**Note:** *The system reduces the engine speed if you continue to operate the engine at a high engine speed.*

**Note:** *Do not restart the engine until the cause of overheating has been determined and resolved.*

## Engine Coolant Temperature Warning Lamp



If it illuminates when your vehicle is moving, this indicates that the engine is overheating. Stop your vehicle as soon as it is safe to do so and switch the engine off. Have your vehicle checked as soon as possible.

# Instrument Cluster - Vehicles With: 4.2 Inch Instrument Cluster Display Screen

## Automatic Transmission Position Indicators

The instrument cluster displays the current position. See **Automatic Transmission Position Indicators** (page 237).

## GAUGES - MILD HYBRID ELECTRIC VEHICLE (MHEV)

### Instrument Cluster

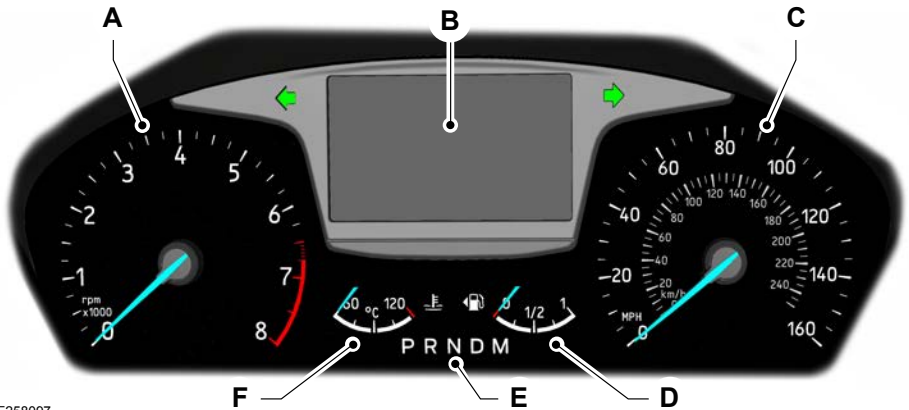

E258097

- A Tachometer.
- B Information display.
- C Speedometer.
- D Fuel gauge.
- E Automatic transmission position indicators.
- F Engine coolant temperature gauge.

### Tachometer

Shows the engine speed. The red line thickens where the engine speed enters the overspeed limiter.

### Information Display

Shows the following information:

- Odometer.
- Trip computer.
- MyView information.
- Driver assistance information.
- Navigation information.

# Instrument Cluster - Vehicles With: 4.2 Inch Instrument Cluster Display Screen

- Audio information.
- Phone information.
- Vehicle and system settings.
- Outside air temperature.
- Shift indicators.

## Odometer

Records the total distance traveled by your vehicle.

The system detects unauthorized odometer adjustments to avoid total distance reading fraud. If the system detects an unauthorized odometer adjustment, the total distance reading displays XXXX. Recovery of the original mileage could result in system damage not covered by the vehicle Warranty and may carry a significant expense.

## Trip Computer

See **Trip Computer** (page 147).

## Vehicle and System Settings

See **General Information** (page 145).

## Shift Indicator

See **Manual Transmission Shift Indicators** (page 235).

## Speedometer

Shows the vehicle speed.

## Fuel Gauge

The fuel gauge indicates approximately how much fuel is in the fuel tank.

The arrow adjacent to the fuel pump symbol indicates on which side of your vehicle the fuel filler door is located.



E236403

- A The fuel filler door is on the left-hand side of your vehicle.
- B The fuel filler door is on the right-hand side of your vehicle.

## Low Fuel Level Warning Lamp



If the fuel gauge icon illuminates when you are driving, refuel as soon as possible.

## Low Fuel Level Audible Warning

For MyKey users, a warning tone sounds and a message appears in the information display when the distance to empty reaches 120 km (75 mi).

For all keys, a warning tone sounds and a message appears in the information display when the distance to empty reaches 80 km (50 mi). A warning tone sounds and a message appears in the information display again at the following distance to empty parameters:

- 40 km (20 mi)
- 20 km (10 mi)
- 0 km (0 mi)

**Note:** *The low fuel reminder appears at different fuel gauge positions depending on fuel economy conditions. This variation is normal.*

# Instrument Cluster - Vehicles With: 4.2 Inch Instrument Cluster Display Screen

## Engine Coolant Temperature Gauge

At normal operating temperature, the needle remains in the center section. If the needle enters the red section, the engine is overheating. Stop your vehicle as soon as it is safe to do so, switch the engine off and allow it to cool.

**Note:** *The system reduces the engine speed if you continue to operate the engine at a high engine speed.*

**Note:** *Do not restart the engine until the cause of overheating has been determined and resolved.*

## Engine Coolant Temperature Warning Lamp



The engine coolant temperature gauge icon illuminates if the systems detects a malfunction.

Have your vehicle checked as soon as possible.

## Automatic Transmission Gearshift Lever Position Indicator

Shows the selected gear. See **Automatic Transmission Position Indicators** (page 237).

## Hybrid Gauge

1. Using the information display controls on the steering wheel, select **MyView**.
2. Select **Hybrid gauge**.

**Note:** *If you select any other screen than the hybrid gauge then the current status indicator of the hybrid system appears in the information display.*



Illuminates in the information display when the mild hybrid system is charging the battery.



Illuminates in the information display when the battery is assisting the powertrain in driving the vehicle.



Illuminates in the information display when the battery is providing a large amount of energy to the powertrain to support a higher rate of acceleration.



Illuminates in the information display when the mild hybrid system cannot provide energy to the powertrain.

# Instrument Cluster - Vehicles With: 12.3 Inch Instrument Cluster Display Screen

## GAUGES - EXCLUDING: MILD HYBRID ELECTRIC VEHICLE (MHEV)/ST

### Instrument Cluster

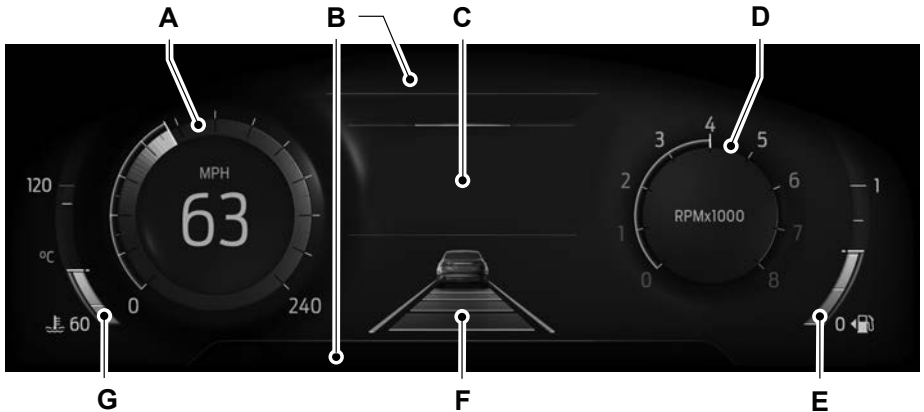

- A Speedometer.
- B Information bar.
- C Information display.
- D Tachometer.
- E Fuel gauge.
- F Driver assistance information.
- G Engine coolant temperature gauge.

### Speedometer

Shows the vehicle speed.

### Information Bar

Shows the following information:

- Audio information.
- Phone information.
- Navigation information.

- Odometer.
- Drive modes.
- Automatic transmission position indicators.
- Shift indicators.
- Outside air temperature.
- Distance to empty.

# Instrument Cluster - Vehicles With: 12.3 Inch Instrument Cluster Display Screen

## Odometer

Records the total distance traveled by your vehicle.

## Information Display

Shows the following information:

- Trip computer.
- Vehicle and system settings.

## Tachometer

Shows the engine speed.

## Fuel Gauge

The fuel gauge indicates approximately how much fuel is in the fuel tank.

The arrow adjacent to the fuel pump symbol indicates on which side of your vehicle the fuel filler door is located.



A



B

E236403

- A The fuel filler door is on the left-hand side of your vehicle.
- B The fuel filler door is on the right-hand side of your vehicle.

## Low Fuel Level Warning Lamp



If it illuminates when you are driving, refuel as soon as possible.

## Low Fuel Level Audible Warning

For MyKey users, a warning tone sounds and a message appears in the information display when the distance to empty reaches 120 km (75 mi).

For all keys, a warning tone sounds and a message appears in the information display when the distance to empty reaches 80 km (50 mi). A warning tone sounds and a message appears in the information display again at the following distance to empty parameters:

- 40 km (20 mi)
- 20 km (10 mi)
- 0 km (0 mi)

**Note:** *The low fuel reminder appears at different fuel gauge positions depending on fuel economy conditions. This variation is normal.*

## Engine Coolant Temperature Gauge

At normal operating temperature, the needle remains in the center section. If the needle enters the red section, the engine is overheating. Stop your vehicle as soon as it is safe to do so, switch the engine off and allow it to cool.

**Note:** *The system reduces the engine speed if you continue to operate the engine at a high engine speed.*

**Note:** *Do not restart the engine until the cause of overheating has been determined and resolved.*

## Engine Coolant Temperature Warning Lamp



If it illuminates when your vehicle is moving, this indicates that the engine is overheating. Stop your vehicle as soon as it is safe to do so and switch the engine off. Have your vehicle checked as soon as possible.

# Instrument Cluster - Vehicles With: 12.3 Inch Instrument Cluster Display Screen

## GAUGES - MILD HYBRID ELECTRIC VEHICLE (MHEV)

### Instrument Cluster

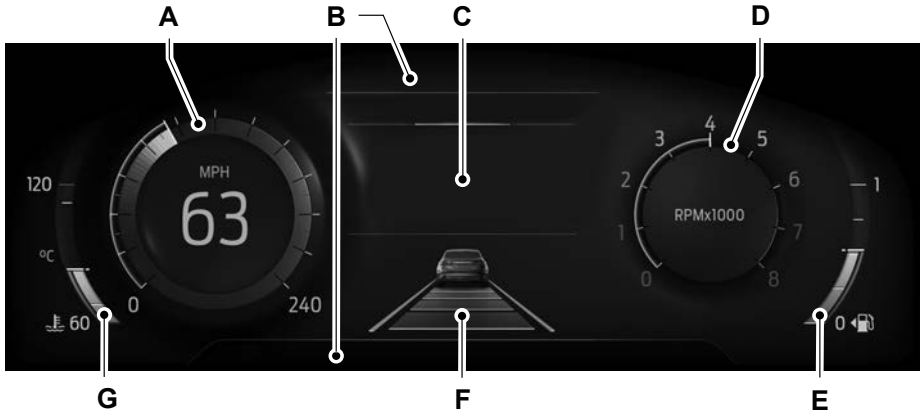

- A Speedometer.
- B Information bar.
- C Information display.
- D Tachometer.
- E Fuel gauge.
- F Driver assistance information.
- G Engine coolant temperature gauge.

### Speedometer

Shows the vehicle speed.

### Information Bar

Shows the following information:

- Audio information.
- Phone information.
- Navigation information.
- Odometer.

- Drive modes.
- Automatic transmission position indicators.
- Shift indicators.
- Outside air temperature.
- Distance to empty.

### Odometer

Records the total distance traveled by your vehicle.



# Instrument Cluster - Vehicles With: 12.3 Inch Instrument Cluster Display Screen

## Information Display

Shows the following information:

- Trip computer.
- Vehicle and system settings.

## Tachometer

Shows the engine speed.

## Fuel Gauge

The fuel gauge indicates approximately how much fuel is in the fuel tank.

The arrow adjacent to the fuel pump symbol indicates on which side of your vehicle the fuel filler door is located.



A



B

E236403

- A The fuel filler door is on the left-hand side of your vehicle.
- B The fuel filler door is on the right-hand side of your vehicle.

## Low Fuel Level Warning Lamp



If it illuminates when you are driving, refuel as soon as possible.

## Low Fuel Level Audible Warning

For MyKey users, a warning tone sounds and a message appears in the information display when the distance to empty reaches 120 km (75 mi).

For all keys, a warning tone sounds and a message appears in the information display when the distance to empty reaches 80 km (50 mi). A warning tone sounds and a message appears in the information display again at the following distance to empty parameters:

- 40 km (20 mi)
- 20 km (10 mi)
- 0 km (0 mi)

**Note:** *The low fuel reminder appears at different fuel gauge positions depending on fuel economy conditions. This variation is normal.*

## Engine Coolant Temperature Gauge

At normal operating temperature, the needle remains in the center section. If the needle enters the red section, the engine is overheating. Stop your vehicle as soon as it is safe to do so, switch the engine off and allow it to cool.

**Note:** *The system reduces the engine speed if you continue to operate the engine at a high engine speed.*

**Note:** *Do not restart the engine until the cause of overheating has been determined and resolved.*

## Engine Coolant Temperature Warning Lamp



If it illuminates when your vehicle is moving, this indicates that the engine is overheating. Stop your vehicle as soon as it is safe to do so and switch the engine off. Have your vehicle checked as soon as possible.

## Hybrid Gauge

1. Press the menu button on the steering wheel to enter the information display main menu.

# Instrument Cluster - Vehicles With: 12.3 Inch Instrument Cluster Display Screen

- 2. Select **Select screens**.
- 3. Select **Hybrid gauge**.

**Note:** If you select any other screen than the hybrid gauge then the current status indicator of the hybrid system appears in the information display.

 Illuminates in the information display when the mild hybrid system is charging the battery.

 Illuminates in the information display when the battery is assisting the powertrain in driving the vehicle.

 Illuminates in the information display when the battery is providing a large amount of energy to the powertrain to support a higher rate of acceleration.

 Illuminates in the information display when the mild hybrid system cannot provide energy to the powertrain.

## GAUGES - ST

### Instrument Cluster

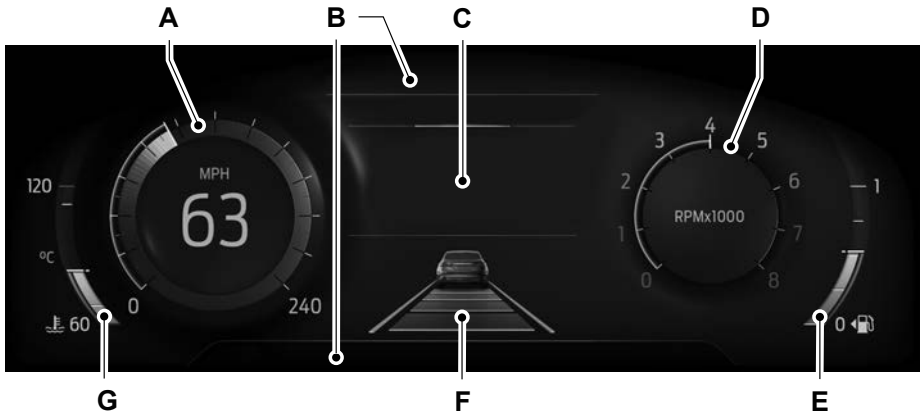

- A Speedometer.
- B Information bar.
- C Information display.
- D Tachometer.
- E Fuel gauge.

# Instrument Cluster - Vehicles With: 12.3 Inch Instrument Cluster Display Screen

- F Driver assistance information.
- G Engine coolant temperature gauge.

## Speedometer

Shows the vehicle speed.

## Information Bar

Shows the following information:

- Audio information.
- Phone information.
- Navigation information.
- Odometer.
- Drive modes.
- Automatic transmission position indicators.
- Shift indicators.
- Performance shift indicator.
- Outside air temperature.
- Distance to empty.

## Odometer

Records the total distance traveled by your vehicle.

## Performance Shift Indicator



It illuminates when the powertrain reaches the optimum upshift point. It flashes when the engine is close to hitting the engine speed limiter.

## Information Display

Shows the following information:

- Trip computer.
- Vehicle and system settings.

## Tachometer

Shows the engine speed.

## Fuel Gauge

The fuel gauge indicates approximately how much fuel is in the fuel tank.

The arrow adjacent to the fuel pump symbol indicates on which side of your vehicle the fuel filler door is located.



A



B

E236403

- A The fuel filler door is on the left-hand side of your vehicle.
- B The fuel filler door is on the right-hand side of your vehicle.

## Low Fuel Level Warning Lamp



If it illuminates when you are driving, refuel as soon as possible.

## Low Fuel Level Audible Warning

For MyKey users, a warning tone sounds and a message appears in the information display when the distance to empty reaches 120 km (75 mi).

For all keys, a warning tone sounds and a message appears in the information display when the distance to empty reaches 80 km (50 mi). A warning tone sounds and a message appears in the information display again at the following distance to empty parameters:

## Instrument Cluster - Vehicles With: 12.3 Inch Instrument Cluster Display Screen

---

- 40 km (20 mi)
- 20 km (10 mi)
- 0 km (0 mi)

**Note:** *The low fuel reminder appears at different fuel gauge positions depending on fuel economy conditions. This variation is normal.*

### Engine Coolant Temperature Gauge

At normal operating temperature, the needle remains in the center section. If the needle enters the red section, the engine is overheating. Stop your vehicle as soon as it is safe to do so, switch the engine off and allow it to cool.

**Note:** *The system reduces the engine speed if you continue to operate the engine at a high engine speed.*

**Note:** *Do not restart the engine until the cause of overheating has been determined and resolved.*

### Engine Coolant Temperature Warning Lamp



If it illuminates when your vehicle is moving, this indicates that the engine is overheating. Stop your vehicle as soon as it is safe to do so and switch the engine off. Have your vehicle checked as soon as possible.

# Information Displays - Vehicles With: 4.2 Inch Instrument Cluster Display Screen

## GENERAL INFORMATION



**WARNING:** Driving while distracted can result in loss of vehicle control, crash and injury. We strongly recommend that you use extreme caution when using any device that may take your focus off the road. Your primary responsibility is the safe operation of your vehicle. We recommend against the use of any hand-held device while driving and encourage the use of voice-operated systems when possible. Make sure you are aware of all applicable local laws that may affect the use of electronic devices while driving.

**Note:** For your safety, some features are speed-dependent. Their use is limited to when your vehicle speed is not moving.

## Information Display Controls



E258761



E250032

- A Return button.
- B OK button.
- C Menu button.

### Return Button

Use the return button to go back or to exit.

### OK Button

Use the **OK** button to make a selection. You can also use it to scroll through a menu.

### Menu Button

Use the menu button on the main screen to display the submenu.

## Information Display Menus

### Main Menu

Menu Item
<b>Trip computer 1</b> or <b>Trip computer 2</b>
MyView
Driver assist.
Navigation

# Information Displays - Vehicles With: 4.2 Inch Instrument Cluster Display Screen

Menu Item
Audio
Phone
Settings

## Submenus

### *Trip computer 1 and Trip computer 2*

Menu Item
Trip computer 1
Trip computer 2
Reset individual values
Configure view

## MyView

Menu Item
Digital speedometer
Fuel economy
Trip computer/audio
Eco coach
Calm screen

## Driver assist.

Menu Item
BLIS
Pre-collision Assist
Traffic sign recognition
Lane keeping system
Driver alert
Wrong way alert

Menu Item
Hill Start Assist
Cross traffic alert
Eco coach
Trailer control
Cruise control
Speed limiter
Rear Park Pilot

## Navigation

Menu Item
Home
Favourite destinations
Previous destinations

## Audio

Menu Item
Radio
USB device.
Bluetooth device.

## Phone

Menu Item
All calls
Incoming calls
Missed calls
Outgoing calls

# Information Displays - Vehicles With: 4.2 Inch Instrument Cluster Display Screen

## Settings

Menu Item
Information
Display
Driver assistance
Vehicle settings
MyKey

## TRIP COMPUTER

You can reset the trip computer and personalize it using the information display. See **Information Displays** (page 145).

### Resetting the Trip Computer

Navigate to the following main menu item.

Menu Item	Action
Trip computer 1	Press and hold the <b>OK</b> button until the system reset confirmation appears.
Trip computer 2	Press and hold the <b>OK</b> button until the system reset confirmation appears.

Alternatively you can reset individual trip values.

Menu Item	Action
Trip computer 1	Press the menu button.
Trip computer 2	Press the menu button.
Reset individual values	Press the <b>OK</b> button.
Reset trip odometer	Press and hold the <b>OK</b> button until the system reset confirmation appears.
Reset trip timer	Press and hold the <b>OK</b> button until the system reset confirmation appears.
Reset average fuel	Press and hold the <b>OK</b> button until the system reset confirmation appears.
Reset average speed	Press and hold the <b>OK</b> button until the system reset confirmation appears.

## Personalization

Navigate to the following main menu item.

# Information Displays - Vehicles With: 4.2 Inch Instrument Cluster Display Screen

Menu Item	Action
Trip computer 1	Press the menu button.
Trip computer 2	Press the menu button.
Configure view	Press the <b>OK</b> button.
Trip odometer	Press the <b>OK</b> button.
Trip timer	Press the <b>OK</b> button.
Average fuel consumption	Press the <b>OK</b> button.
Average speed	Press the <b>OK</b> button.
Distance to empty	Press the <b>OK</b> button.
Instantaneous fuel	Press the <b>OK</b> button.

**Note:** You can display a maximum of four values.

## Trip Odometer

Registers the total distance since you last reset the value.

## Trip Timer

Registers the total time since you last reset the value.

## Average Fuel

Indicates the average fuel consumption since you last reset the value.

## Average Speed

Indicates the average vehicle speed since you last reset the value.

## Distance to Empty

Indicates the approximate distance your vehicle could travel on the fuel remaining in the fuel tank. Changes in driving pattern may cause the value to vary.

## Instantaneous Fuel

Indicates the current fuel consumption.

## PERSONALIZED SETTINGS

### Language

Menu Item	Action
Settings	Press the menu button.
Display	Press the <b>OK</b> button.
Language	Press the <b>OK</b> button. Choose your applicable setting.



# Information Displays - Vehicles With: 4.2 Inch Instrument Cluster Display Screen

---

## Measure Unit

Menu Item	Action
Settings	Press the menu button.
Display	Press the <b>OK</b> button.
Measurement unit	Press the <b>OK</b> button. Choose your applicable setting.

## Temperature Unit

Menu Item	Action
Settings	Press the menu button.
Display	Press the <b>OK</b> button.
Temperature unit	Press the <b>OK</b> button. Choose your applicable setting.

## Tire Pressure Unit (If Equipped)

Menu Item	Action
Settings	Press the menu button.
Display	Press the <b>OK</b> button.
Tyre pressure	Press the <b>OK</b> button. Choose your applicable setting.

## Chimes

Menu Item	Action
Settings	Press the menu button.
Vehicle settings	Press the <b>OK</b> button.
Chimes	Press the <b>OK</b> button.
Parking space found	Press the <b>OK</b> button.
Information	Press the <b>OK</b> button.

# Information Displays - Vehicles With: 4.2 Inch Instrument Cluster Display Screen

## HEAD UP DISPLAY



E261230

The system displays information on a display screen in your field of vision, allowing you to keep your eyes on the road. You can select which information the system displays.

**Note:** Do not place anything on the head up display, for example sunglasses or a cell phone. This can cause damage not covered by the vehicle Warranty.

### Cleaning the Head Up Display

Use a damp, lint-free cloth to clean the head up display.

**Note:** Do not touch the display screen or mirror.

**Note:** Do not use household cleaning products or glass cleaners. This can cause damage not covered by the vehicle Warranty.

### Switching the Head Up Display On or Off



Press the button on the center console.

**Note:** The head up display menu appears in the information display.

### Use the information display controls on the steering wheel to select the following:

Menu Item	Action
Head-up display (HUD)	Press the <b>OK</b> button.
	Press the <b>OK</b> button.

**Note:** The system remembers the last setting when you start the engine.

### Adjusting the Head Up Display Settings

Start the engine and switch the system on.

**Note:** Press the button on the center console if you do not see the head up display menu in the information display.

**Note:** For your safety, some features are speed-dependent. Their use is limited to when your vehicle is not moving.

Use the information display controls on the steering wheel to adjust the head up display settings.

## Information Displays - Vehicles With: 4.2 Inch Instrument Cluster Display Screen

Menu Item	Action
Adjustment	Press the <b>OK</b> button.
Position	<ol style="list-style-type: none"><li>1. Press the <b>OK</b> button.</li><li>2. Use the menu button to adjust the vertical position of the blue frame.<ul style="list-style-type: none"><li>• Make sure that you can see all of the blue frame.</li><li>• Do not physically move the screen. This can cause damage not covered by the vehicle Warranty.</li></ul></li></ol>
Brightness	<ol style="list-style-type: none"><li>1. Press the <b>OK</b> button.</li><li>2. Use the menu button to adjust the brightness of the display screen.<ul style="list-style-type: none"><li>• The system adjusts the brightness based on how dark it is. If you set the brightness to a high level, the system reduces the brightness at night.</li></ul></li></ol>
Vertical size	<ol style="list-style-type: none"><li>1. Press the <b>OK</b> button.</li><li>2. Use the menu button to adjust the vertical size of the display screen.<ul style="list-style-type: none"><li>• A small vertical size could be more suitable if you sit in a high position.</li></ul></li></ol>

### Selecting Which Information the System Displays

Start the engine and switch the system on.

**Note:** Press the button on the center console if you do not see the head up display menu in the information display.

**Note:** For your safety, some features are speed-dependent. Their use is limited to when your vehicle is not moving.

Use the information display controls on the steering wheel to select which information the system displays.

Menu Item	Action
Content	Press the <b>OK</b> button. Select a menu item. Press the <b>OK</b> button.

# Information Displays - Vehicles With: 4.2 Inch Instrument Cluster Display Screen

## Head Up Display Indicator



**Note:** The head up display indicator could illuminate to supplement an information message.

## Head Up Display Information Messages

Message	Action
Heads-up display System malfunction See manual	The system has malfunctioned or the display is obstructed. Make sure that the head up display is free from obstruction. If the message continues to appear, have your vehicle checked as soon as possible.
Head-up display To position use the information display	Press the button on the center console. The head up display menu appears in the information display. Make sure the blue frame is fully visible. Do not manually move the screen. This can cause damage not covered by the vehicle Warranty.

**Note:** Information messages only appear in the information display.

# Information Displays - Vehicles With: 12.3 Inch Instrument Cluster Display Screen

## GENERAL INFORMATION

**WARNING:** Driving while distracted can result in loss of vehicle control, crash and injury. We strongly recommend that you use extreme caution when using any device that may take your focus off the road. Your primary responsibility is the safe operation of your vehicle. We recommend against the use of any hand-held device while driving and encourage the use of voice-operated systems when possible. Make sure you are aware of all applicable local laws that may affect the use of electronic devices while driving.

**Note:** For your safety, some features are speed-dependent. Their use is limited to when your vehicle speed is not moving.

## Information Display Controls



E250032

- A Return button.
- B OK button.
- C Menu button.

### Return Button

Use the return button to go back or to exit.

### OK Button

Use the **OK** button to make a selection. You can also use it to scroll through a menu.

### Menu Button

Use the menu button on the main screen to enter the main menu. You can also use it to return to the main screen.

## Information Display Main Menu

Menu Item
Select screens
Phone
Navigation
Audio
Settings
Display settings

# Information Displays - Vehicles With: 12.3 Inch Instrument Cluster Display Screen

## TRIP COMPUTER

You can display the trip computer on your main screen. See **Personalized Settings** (page 154).

The trip computer shows the following information:

- Trip odometer.
- Average fuel.
- Trip timer.

### Trip Odometer

Registers the total distance since you last reset the value.

### Average Fuel

Indicates the average fuel consumption since you last reset the value.

### Trip Timer

Registers the total time since you last reset the value.

### Resetting the Trip Computer

1. Navigate to the main screen.
2. Select **Trip computer 1** or **Trip computer 2**.
3. Press and hold the **OK** button for a few seconds.

## PERSONALIZED SETTINGS

### Main Screen

1. Press the menu button on the steering wheel to enter the information display main menu.
2. Select **Select screens**.
3. Select the screens that you want to display on your main screen.

### Speedometer

1. Press the menu button on the steering wheel to enter the information display main menu.
2. Select **Display settings**.
3. Switch **Speedometer km/h** or **Speedometer mph** on or off.

### Tachometer

1. Press the menu button on the steering wheel to enter the information display main menu.
2. Select **Display settings**.
3. Switch **Show tachometer** on or off.

### Measure Unit

1. Press the menu button on the steering wheel to enter the information display main menu.
2. Select **Display settings**.
3. Select **Measurement units**.
4. Select a setting and press the **OK** button.

### Temperature Unit

1. Press the menu button on the steering wheel to enter the information display main menu.
2. Select **Display settings**.
3. Select **Temperature units**.
4. Select a setting and press the **OK** button.

### Tire Pressure Unit

1. Press the menu button on the steering wheel to enter the information display main menu.
2. Select **Display settings**.
3. Select **Tyre pressure**.

# Information Displays - Vehicles With: 12.3 Inch Instrument Cluster Display Screen

4. Select a setting and press the **OK** button.

## Language

1. Press the menu button on the steering wheel to enter the information display main menu.
2. Select **Display settings**.
3. Select **Language**.
4. Select a setting and press the **OK** button.

## Chimes

1. Press the menu button on the steering wheel to enter the information display main menu.
2. Select **Settings**.
3. Select **Vehicle**.
4. Select **Chimes**.
5. Select a setting and press the **OK** button.

## HEAD UP DISPLAY



E261230

The system displays information on a display screen in your field of vision, allowing you to keep your eyes on the road. You can select which information the system displays.

**Note:** Do not place anything on the head up display, for example sunglasses or a cell phone. This can cause damage not covered by the vehicle Warranty.

## Cleaning the Head Up Display

Use a damp, lint-free cloth to clean the head up display.

**Note:** Do not touch the display screen or mirror.

**Note:** Do not use household cleaning products or glass cleaners. This can cause damage not covered by the vehicle Warranty.

## Switching the Head Up Display On or Off



Press the button on the center console.

**Note:** The head up display menu appears in the information display.

# Information Displays - Vehicles With: 12.3 Inch Instrument Cluster Display Screen

**Use the information display controls on the steering wheel to select the following:**

Menu Item	Action
Head-up display (HUD)	Press the <b>OK</b> button.
	Press the <b>OK</b> button.

**Note:** The system remembers the last setting when you start the engine.

## Adjusting the Head Up Display Settings

Start the engine and switch the system on.

**Note:** Press the button on the center console if you do not see the head up display menu in the information display.

**Note:** For your safety, some features are speed-dependent. Their use is limited to when your vehicle is not moving.

Use the information display controls on the steering wheel to adjust the head up display settings.

Menu Item	Action
Adjustment	Press the <b>OK</b> button.
Position	<ol style="list-style-type: none"> <li>1. Press the <b>OK</b> button.</li> <li>2. Use the menu button to adjust the vertical position of the blue frame. <ul style="list-style-type: none"> <li>• Make sure that you can see all of the blue frame.</li> <li>• Do not physically move the screen. This can cause damage not covered by the vehicle Warranty.</li> </ul> </li> </ol>
Brightness	<ol style="list-style-type: none"> <li>1. Press the <b>OK</b> button.</li> <li>2. Use the menu button to adjust the brightness of the display screen. <ul style="list-style-type: none"> <li>• The system adjusts the brightness based on how dark it is. If you set the brightness to a high level, the system reduces the brightness at night.</li> </ul> </li> </ol>
Vertical size	<ol style="list-style-type: none"> <li>1. Press the <b>OK</b> button.</li> <li>2. Use the menu button to adjust the vertical size of the display screen. <ul style="list-style-type: none"> <li>• A small vertical size could be more suitable if you sit in a high position.</li> </ul> </li> </ol>



# Information Displays - Vehicles With: 12.3 Inch Instrument Cluster Display Screen

## Selecting Which Information the System Displays

Start the engine and switch the system on.

**Note:** Press the button on the center console if you do not see the head up display menu in the information display.

**Note:** For your safety, some features are speed-dependent. Their use is limited to when your vehicle is not moving.

Use the information display controls on the steering wheel to select which information the system displays.

Menu Item	Action
Content	Press the <b>OK</b> button. Select a menu item. Press the <b>OK</b> button.

## Head Up Display Indicator



**Note:** The head up display indicator could illuminate to supplement an information message.

## Head Up Display Information Messages

Message	Action
Heads-up display System malfunction See manual	The system has malfunctioned or the display is obstructed. Make sure that the head up display is free from obstruction. If the message continues to appear, have your vehicle checked as soon as possible.
Head-up display To position use the information display	Press the button on the center console. The head up display menu appears in the information display. Make sure the blue frame is fully visible. Do not manually move the screen. This can cause damage not covered by the vehicle Warranty.

**Note:** Information messages only appear in the information display.

# Remote Start - Automatic Transmission

## WHAT IS REMOTE START

The system allows you to remotely start your vehicle and therefore to heat or cool the interior to a predetermined temperature.

## REMOTE START LIMITATIONS

Remote start does not work if:

- The alarm horn is sounding.
- The hood is open.
- The transmission is not in park (P).
- Remote start is not enabled.
- The ignition is on.

**Note:** Do not use remote start if your fuel level is low.

## ENABLING REMOTE START - VEHICLES WITH: 4.2 INCH INSTRUMENT CLUSTER DISPLAY SCREEN

1. Using the information display controls on the steering wheel, select **Settings**.
2. Select **Vehicle settings**.
3. Select **Remote start**.
4. Switch **System** on.

**Note:** To use remote start, make sure that the modem is enabled. See **Enabling and Disabling the Modem** (page 497).

## ENABLING REMOTE START - VEHICLES WITH: 12.3 INCH INSTRUMENT CLUSTER DISPLAY SCREEN

1. Press the menu button on the steering wheel to enter the information display main menu.

2. Select **Settings**.
3. Select **Vehicle**.
4. Select **Remote start**.
5. Switch **System** on.

**Note:** To use remote start, make sure that the modem is enabled. See **Enabling and Disabling the Modem** (page 497).

## REMOTELY STARTING AND STOPPING THE VEHICLE

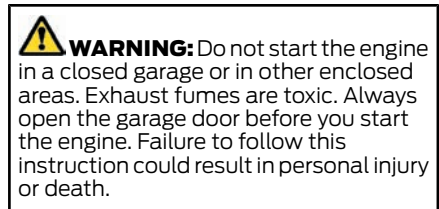

Use the FordPass App to start the vehicle.

**Note:** The turn signal lamps flash twice.

**Note:** The parking lamps turn on when the vehicle is running.

**Note:** The horn sounds if the system fails to start.

**Note:** All other vehicle systems remain off when you have remotely started the vehicle.

**Note:** You may have to wait a short period of time before remotely starting the vehicle after the vehicle stops running.

**Note:** The vehicle remains secured when you have remotely started it. A valid key must be inside your vehicle to switch the ignition on and drive your vehicle.

**Note:** A maximum of two remote starts are allowed. After that you need to turn the ignition on and off before you can use remote start again.

Use the FordPass App to switch the vehicle off.

# Remote Start - Automatic Transmission

## REMOTE START SETTINGS - VEHICLES WITH: 4.2 INCH INSTRUMENT CLUSTER DISPLAY SCREEN, VEHICLES WITHOUT: HEATED STEERING WHEEL

### Climate Control Settings

1. Using the information display controls on the steering wheel, select **Settings**.
2. Select **Vehicle settings**.
3. Select **Remote start**.
4. Select **Climate control**.
5. Select **Auto** or **Last settings**.

**Note:** If you select **Auto**, the system attempts to heat or cool the interior to 22°C (72°F).

**Note:** If you select **Last settings**, the system remembers the last used settings.

**Note:** You cannot adjust the climate control settings when you have remotely started the vehicle.

**Note:** When you switch the ignition on, the climate control system returns to the last used settings.

### Heated Seat Settings

1. Using the information display controls on the steering wheel, select **Settings**.
2. Select **Vehicle settings**.
3. Select **Remote start**.
4. Select **Seats**.
5. Select **Auto** or **Off**.

**Note:** If you switch the heated seat settings to **Auto**, the heated seats turn on during cold weather.

**Note:** You cannot adjust the heated seat settings when you have remotely started the vehicle.

## Setting the Remote Start Duration

You can set a duration for Remote Start to run.

1. Using the information display controls on the steering wheel, select **Settings**.
2. Select **Vehicle settings**.
3. Select **Remote start**.
4. Select **Duration**.

## REMOTE START SETTINGS - VEHICLES WITH: 12.3 INCH INSTRUMENT CLUSTER DISPLAY SCREEN, VEHICLES WITHOUT: HEATED STEERING WHEEL

### Climate Control Settings

1. Press the menu button on the steering wheel to enter the information display main menu.
2. Select **Settings**.
3. Select **Vehicle**.
4. Select **Remote start**.
5. Select **Climate control**.
6. Select **Auto** or **Last settings**.

**Note:** If you select **Auto**, the system attempts to heat or cool the interior to 22°C (72°F).

**Note:** If you select **Last settings**, the system remembers the last used settings.

**Note:** You cannot adjust the climate control settings when you have remotely started the vehicle.

**Note:** When you switch the ignition on, the climate control system returns to the last used settings.

# Remote Start - Automatic Transmission

## Heated Seat Settings

1. Press the menu button on the steering wheel to enter the information display main menu.
2. Select **Settings**.
3. Select **Vehicle**.
4. Select **Remote start**.
5. Select **Seats**.
6. Select **Auto** or **Off**.

**Note:** If you switch the heated seat settings to **Auto**, the heated seats turn on during cold weather.

**Note:** You cannot adjust the heated seat settings when you have remotely started the vehicle.

## Setting the Remote Start Duration

You can set a duration for Remote Start to run.

1. Press the menu button on the steering wheel to enter the information display main menu.
2. Select **Settings**.
3. Select **Vehicle**.
4. Select **Remote start**.
5. Select **Duration**.

## REMOTE START SETTINGS - VEHICLES WITH: 4.2 INCH INSTRUMENT CLUSTER DISPLAY SCREEN/HEATED STEERING WHEEL

### Climate Control Settings

1. Using the information display controls on the steering wheel, select **Settings**.
2. Select **Vehicle settings**.
3. Select **Remote start**.

4. Select **Climate control**.
5. Select **Auto** or **Last settings**.

**Note:** If you select **Auto**, the system attempts to heat or cool the interior to 22°C (72°F).

**Note:** If you select **Last settings**, the system remembers the last used settings.

**Note:** You cannot adjust the climate control settings when you have remotely started the vehicle.

**Note:** When you switch the ignition on, the climate control system returns to the last used settings.

### Heated Seat and Steering Wheel Settings

1. Using the information display controls on the steering wheel, select **Settings**.
2. Select **Vehicle settings**.
3. Select **Remote start**.
4. Select **Seats and steering**.
5. Select **Auto** or **Off**.

**Note:** If you switch the heated seat and steering wheel settings to **Auto**, the heated seats and steering wheel turn on during cold weather.

**Note:** You cannot adjust the heated seat and steering wheel settings when you have remotely started the vehicle.

## Setting the Remote Start Duration

You can set a duration for Remote Start to run.

1. Using the information display controls on the steering wheel, select **Settings**.
2. Select **Vehicle settings**.
3. Select **Remote start**.
4. Select **Duration**.

# Remote Start - Automatic Transmission

---

## REMOTE START SETTINGS - VEHICLES WITH: 12.3 INCH INSTRUMENT CLUSTER DISPLAY SCREEN/HEATED STEERING WHEEL

### Climate Control Settings

1. Press the menu button on the steering wheel to enter the information display main menu.
2. Select **Settings**.
3. Select **Vehicle**.
4. Select **Remote start**.
5. Select **Climate control**.
6. Select **Auto** or **Last settings**.

**Note:** If you select **Auto**, the system attempts to heat or cool the interior to 22°C (72°F).

**Note:** If you select **Last settings**, the system remembers the last used settings.

**Note:** You cannot adjust the climate control settings when you have remotely started the vehicle.

**Note:** When you switch the ignition on, the climate control system returns to the last used settings.

### Heated Seat and Steering Wheel Settings

1. Press the menu button on the steering wheel to enter the information display main menu.
2. Select **Settings**.
3. Select **Vehicle**.
4. Select **Remote start**.
5. Select **Seats and steering**.
6. Select **Auto** or **Off**.

**Note:** If you switch the heated seat and steering wheel settings to **Auto**, the heated seats and steering wheel turn on during cold weather.

**Note:** You cannot adjust the heated seat and steering wheel settings when you have remotely started the vehicle.

### Setting the Remote Start Duration

You can set a duration for Remote Start to run.

1. Press the menu button on the steering wheel to enter the information display main menu.
2. Select **Settings**.
3. Select **Vehicle**.
4. Select **Remote start**.
5. Select **Duration**.

# Climate Control

## MANUAL CLIMATE CONTROL

### Switching the Climate Control On and Off



### Switching the Recirculated Air On and Off



**Note:** The air currently in the passenger compartment recirculates.

### Switching the Air Conditioning On and Off



**Note:** Under certain conditions, the air conditioning compressor could continue to operate after you switch air conditioning off.

### Switching Maximum Defrost On and Off



Turn the temperature control clockwise past the highest setting to maximize defrosting.

**Note:** The temperature control springs back to the highest setting.

**Note:** When you switch maximum defrost on, the heated windshield, heated rear window and air conditioning turn on. The blower motor is set to the highest speed.

**Note:** When you switch maximum defrost off, the heated windshield and heated rear window remain on.

### Switching Maximum Cooling On and Off



Turn the temperature control counterclockwise past the lowest setting to maximize cooling.

**Note:** The temperature control springs back to the lowest setting.

**Note:** When you switch maximum cooling off, air conditioning remains on.

### Setting the Blower Motor Speed



**Note:** Lights on the control illuminate to indicate the blower motor speed.

**Note:** When you switch the blower motor off, air conditioning turns off and the windows could fog up.

### Directing Air to the Windshield Air Vents



### Directing Air to the Instrument Panel Air Vents



### Directing Air to the Footwell Air Vents



# Climate Control

## Setting the Temperature

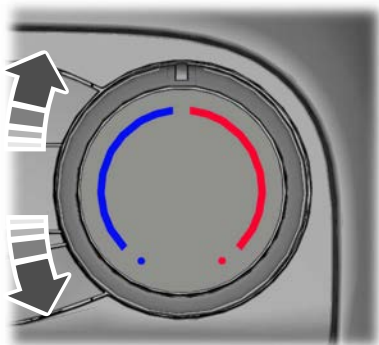

Turn the temperature control counterclockwise for cooler temperature settings.

Turn the temperature control clockwise for warmer temperature settings.

## AUTOMATIC CLIMATE CONTROL

### Switching the Climate Control On and Off



### Switching the Recirculated Air On and Off



**Note:** The air currently in the passenger compartment recirculates.

**Note:** Recirculated air could turn off or be prevented from turning on in all air flow modes except maximum cooling to reduce the risk of the windows fogging up. It could also turn on and off when you direct air to the instrument panel or footwell air vents during hot weather to improve cooling efficiency.

### Switching the Air Conditioning On and Off



**Note:** Under certain conditions, the air conditioning compressor could continue to operate after you switch air conditioning off.

### Switching Maximum Defrost On and Off



**Note:** When you switch maximum defrost on, the heated windshield, heated rear window and air conditioning turn on. The blower motor is set to the highest speed.

**Note:** When you switch maximum defrost off, the heated windshield and heated rear window remain on.

### Switching Maximum Cooling On and Off



**Note:** When you switch maximum cooling off, air conditioning remains on.

### Switching Auto Mode On and Off



Press the button to switch auto mode on. Repeatedly press the button to adjust auto mode.

# Climate Control

**Note:** When you switch auto mode on, lights on the blower motor control do not illuminate to indicate the blower motor speed.

Adjust the blower motor control or air distribution control to switch auto mode off.

## Auto Mode Indicator Status

Auto Mode Indicator Status	Description
One indicator illuminated.	<ul style="list-style-type: none"> <li>The blower motor speed is reduced.</li> <li>Use this setting to minimize the amount of noise from the blower motor.</li> <li>This setting increases the time taken to cool the interior.</li> </ul>
Two indicators illuminated.	<ul style="list-style-type: none"> <li>The blower motor speed is moderate.</li> </ul>
Three indicators illuminated.	<ul style="list-style-type: none"> <li>The blower motor speed is increased.</li> <li>Use this setting to reduce the time taken to cool the interior.</li> <li>This setting increases the amount of noise from the blower motor.</li> </ul>

## Setting the Blower Motor Speed



**Note:** Lights on the control illuminate to indicate the blower motor speed.

## Switching Dual Mode On and Off



**Note:** When you switch dual mode on, the passenger side temperature control can be independently adjusted.

**Note:** You can also switch dual mode on by adjusting the passenger side temperature control.

## Directing Air to the Windshield Air Vents



## Directing Air to the Instrument Panel Air Vents



## Directing Air to the Footwell Air Vents





# Climate Control

## Setting the Temperature

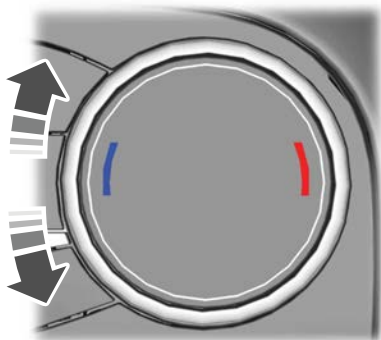

Turn the temperature control counterclockwise for cooler temperature settings.

Turn the temperature control clockwise for warmer temperature settings.

**Note:** You can adjust the temperature between 15.5–29.5°C (60–85°F).

## HINTS ON CONTROLLING THE INTERIOR CLIMATE - VEHICLES WITH: AUTOMATIC TEMPERATURE CONTROL

### General Hints

Do not place objects under the front seats as this may interfere with directing air to the rear seats.

Remove any snow, ice or leaves from the air intake area at the base of the windshield.

**Note:** You may feel a small amount of air from the footwell air vents regardless of the air distribution setting.

**Note:** To reduce humidity build-up inside your vehicle, do not drive with the system switched off or with recirculated air always switched on.

**Note:** Prolonged use of recirculated air may cause the windows to fog up.

**Note:** Use air conditioning with recirculated air to improve cooling performance and efficiency.

**Note:** When you select automatic mode and the outside temperature is low and the engine is cold, air is directed to the windshield and the outer instrument panel air vents.

**Note:** When you select automatic mode and the outside temperature and in-vehicle temperature is high, the system temporarily selects recirculated air to maximize cooling.

**Note:** When you select maximum defrost, air conditioning turns on and air is directed to the windshield air vents.

## Recommended Settings for Heating

- Press **AUTO**.
- Select the required temperature.

**Note:** Adjusting the settings when your vehicle interior is extremely hot or cold is not necessary. The system automatically adjusts to heat or cool the interior to your selected temperature as quickly as possible. For the system to function efficiently, the instrument panel and side air vents should be fully open.

## Quickly Cooling the Interior

- Press **MAX A/C**.

**Note:** To improve the time to reach a comfortable temperature in hot weather, drive with the windows open until you feel cold air through the air vents.

# Climate Control

## Recommended Settings for Cooling

- Press **AUTO**.
- Select the required temperature.

## Defogging the Side Windows in Cold Weather

- Select maximum defrost.

## Defogging or Clearing the Windshield of Thin Ice

- Select maximum defrost.

## HINTS ON CONTROLLING THE INTERIOR CLIMATE - VEHICLES WITH: MANUAL TEMPERATURE CONTROL

### General Hints

Do not place objects under the front seats as this may interfere with directing air to the rear seats.

Remove any snow, ice or leaves from the air intake area at the base of the windshield.

**Note:** You may feel a small amount of air from the footwell air vents regardless of the air distribution setting.

**Note:** To reduce humidity build-up inside your vehicle, do not drive with the system switched off or with recirculated air always switched on.

**Note:** To reduce fogging of the windshield during humid weather conditions, direct air to the windshield air vents.

**Note:** Prolonged use of recirculated air may cause the windows to fog up.

**Note:** Use air conditioning with recirculated air to improve cooling performance and efficiency.

## Quickly Heating the Interior

- Select the highest blower motor speed.
- Select the highest temperature.
- Direct air to the footwell air vents.

## Recommended Settings for Heating

- Select a medium blower motor speed.
- Select the required temperature.
- Direct air to the footwell and windshield air vents.

## Quickly Cooling the Interior

- Select maximum cooling.

**Note:** To improve the time to reach a comfortable temperature in hot weather, drive with the windows open until you feel cold air through the air vents.

## Recommended Settings for Cooling

- Select a medium blower motor speed.
- Select the required temperature.
- Direct air to the instrument panel air vents.
- Press A/C.

## Defogging the Side Windows in Cold Weather

- Select maximum defrost.

## Defogging or Clearing the Windshield of Thin Ice

- Select maximum defrost.

## HEATED WINDSHIELD



Press the button to clear the windshield of thin ice and fog. The heated windshield turns off after a short period of time.

# Climate Control

**Note:** Make sure that the engine is running before switching the heated windshield on.

**Note:** The system does not operate if the battery charge level is low.

## HEATED REAR WINDOW - VEHICLES WITH: AUTOMATIC TEMPERATURE CONTROL



Press the button to clear the rear window of thin ice and fog. The heated rear window turns off after a short period of time.

**Note:** Make sure the engine is on before operating the heated windows.

**Note:** Do not use harsh chemicals, razor blades or other sharp objects to clean or remove decals from the inside of the heated rear window. The vehicle warranty may not cover damage to the heated rear window grid lines.

## HEATED REAR WINDOW - VEHICLES WITH: MANUAL TEMPERATURE CONTROL



Press the button to clear the rear window of thin ice and fog. The heated rear window turns off after a short period of time.

**Note:** Make sure the engine is on before operating the heated windows.

**Note:** Do not use razor blades or other sharp objects to clean or remove decals from the inside of the heated rear window. The vehicle Warranty may not cover damage caused to the heated rear window grid lines.

## HEATED EXTERIOR MIRRORS

When you switch the heated rear window on, the heated exterior mirrors turn on.

**Note:** Do not remove ice from the mirrors with a scraper or adjust the mirror glass when it is frozen in place.

**Note:** Do not clean the mirror housing or glass with harsh abrasives, fuel or other petroleum-based cleaning products. The vehicle warranty may not cover damage caused to the mirror housing or glass.

## AUXILIARY HEATER - VEHICLES WITH: 4.2 INCH INSTRUMENT CLUSTER DISPLAY SCREEN

### Principle of Operation

The system is designed to reduce the time needed to heat the engine when it is running. It turns on or off depending on the outside air temperature and the coolant temperature.

The system warms the engine and the vehicle interior. It uses fuel from the vehicle fuel tank.

### Using the Auxiliary Heater



**WARNING:** We recommend that you have a qualified technician check and repair the heater system after a crash. Failure to follow this instruction could result in personal injury or death.



**WARNING:** Do not use the fuel-operated parking heater at fuel filling stations or near sources of combustible vapors, dust or in enclosed spaces. This could result in serious personal injury or death.

# Climate Control

**Note:** The system does not operate if the battery charge level is low.

**Note:** Make sure the heater exhaust outlet, in front of the right-hand front tire, is free from snow, ice, mud and any other blockages to avoid issues with the heater operation.

**Note:** When the system is on, exhaust fumes come from under your vehicle. This is normal.

**Note:** If the heater is in the process of stopping, excess fuel in the heater burns out and there is some heat, exhaust and noise.

## Switching the Auxiliary Heater On and Off

To switch the auxiliary heater on or off, use the information display controls on the steering wheel to select the following:

Menu Item	Action
Settings	Press the menu button.
Vehicle settings	Press the <b>OK</b> button.
Aux heater	Press the <b>OK</b> button.

## Secondary Interior Heating System Active Indicator



It illuminates when you switch the system on.

## Parking Heater

### Principle of Operation

The system is designed to provide heat when your vehicle is parked.

The system warms the engine and the vehicle interior. It uses fuel from the vehicle fuel tank.

**Note:** Make sure the heater exhaust outlet, in front of the right-hand front tire, is free from snow, ice, mud and any other blockages to avoid issues with the heater operation.

## Using the Parking Heater



**WARNING:** We recommend that you have a qualified technician check and repair the heater system after a crash. Failure to follow this instruction could result in personal injury or death.



**WARNING:** Do not use the fuel-operated parking heater at fuel filling stations or near sources of combustible vapors, dust or in enclosed spaces. This could result in serious personal injury or death.

The system does not operate if the battery charge level is low.

The system only operates when your vehicle is stationary with the engine off.

When you correctly use the system it:

- Keeps the windows clear of thin ice and helps prevent condensation.
- Assists the engine to reach normal operating temperature sooner.

# Climate Control

**Note:** If the heater is in the process of stopping, excess fuel in the heater burns out and there is some heat, exhaust and noise.

## Parking Heater Information Messages

Message	Action
Park heater not started Low fuel level	Displays if the parking heater fails to operate due to low fuel level. Refuel as soon as possible.

## Switching Continue Heat On

When you switch the ignition off, the heater starts or continues running if conditions permit for up to 30 minutes.

**Note:** You can use this mode to maintain a warm cabin after you switch the ignition off. After the heater completes this mode, the check box in the information display resets to unchecked.

**To switch continue heat on, use the information display controls on the steering wheel to select the following:**

Menu Item	Action
Settings	Press the menu button.
Vehicle settings	Press the <b>OK</b> button.
Park heater	Press the <b>OK</b> button.
Continue heat	Press the <b>OK</b> button.

# Climate Control

## Setting the Timer

**The system has three different modes, that you can set in the information display.**

Timer Mode	Description
Once	Allows you to set one heating cycle for a specific day. If conditions permit, the heater starts up to 40 minutes prior to the set date and time. <sup>1</sup>
Time one	Allows you to program a heating cycle for each day of the week. The time remains stored and the system warms up your vehicle prior to the programmed departure times.
Time two	Allows you to program a second heating cycle for each day of the week. The time remains stored and the system warms up your vehicle prior to the programmed departure times.

<sup>1</sup>You must set the day and time for this mode before you check the box in the information display.

**Note:** *The time and date on your vehicle clock must be correctly set.*

**To set a timer mode, use the information display controls on the steering wheel to select the following:**

Menu Item	Action
Settings	Press the menu button.
Vehicle settings	Press the <b>OK</b> button.
Park heater	Press the <b>OK</b> button.
Heater programming	Press the <b>OK</b> button.
Activate	Press the <b>OK</b> button.
Once	Press the <b>OK</b> button.
Activate	Press the <b>OK</b> button.
Time one	Press the <b>OK</b> button.
Activate	Press the <b>OK</b> button.
Time two	Press the <b>OK</b> button.
Activate	Press the <b>OK</b> button.

# Climate Control

## Switching the Parking Heater On and Off With the Remote Control

The parking heater transmitter allows you to remotely request the heater to start and run for up to 30 minutes or to stop all heater modes.

**Note:** Up to three transmitters can be paired to your vehicle.

**Note:** The LED light on the remote transmitter does not indicate the actual status of the heater. The light does not guarantee the heater received a signal to start or stop.

**Note:** Electronic devices that operate in the same frequency may affect the range of the transmitter.

Press and hold the **ON** or **HEAT** button on the transmitter until a green LED light illuminates on the transmitter.

Press and hold the **OFF** button on the transmitter until a red LED light illuminates on the transmitter. This applies only for the heater mode running at the present time, so future timer settings or future continue heat settings do not disable.

**The following table lists the parking heater remote control indications.**

Transmitter LED	Description
Green	The transmitter sent a radio signal.
Flashing green	The transmitter sent a radio signal, but the heater did not receive the signal.
Orange to green	The transmitter sent a radio signal, but the transmitter battery charge is low.
Orange to flashing green	The transmitter did not send a radio signal as the transmitter battery charge is low.
Flashing orange	The transmitter battery charge is low.
Red	The transmitter sent a radio signal.
Flashing red	The transmitter sent a radio signal, but the heater did not receive the signal.
Orange to red	The transmitter sent a radio signal, but the transmitter battery charge is low.
Orange to flashing red	The transmitter did not send a radio signal as the transmitter battery charge is low.

# Climate Control

## AUXILIARY HEATER - VEHICLES WITH: 12.3 INCH INSTRUMENT CLUSTER DISPLAY SCREEN

### Principle of Operation

The system is designed to reduce the time needed to heat the engine when it is running. It turns on or off depending on the outside air temperature and the coolant temperature.

The system warms the engine and the vehicle interior. It uses fuel from the vehicle fuel tank.

### Using the Auxiliary Heater



**WARNING:** We recommend that you have a qualified technician check and repair the heater system after a crash. Failure to follow this instruction could result in personal injury or death.



**WARNING:** Do not use the auxiliary heater at fuel filling stations or near sources of combustible vapors, dust or in enclosed spaces. Failure to follow this instruction could result in personal injury or death.

**Note:** *The system does not operate if the battery charge level is low.*

**Note:** *Make sure the heater exhaust outlet, in front of the right-hand front tire, is free from snow, ice, mud and any other blockages to avoid issues with the heater operation.*

**Note:** *When the system is on, exhaust fumes come from under your vehicle. This is normal.*

**Note:** *If the heater is in the process of stopping, excess fuel in the heater burns out and there is some heat, exhaust and noise.*

### Switching the Auxiliary Heater On and Off

**Press the menu button on the steering wheel to enter the information display main menu:**

Menu Item	Action
Settings	Press the <b>OK</b> button.
Vehicle	Press the <b>OK</b> button.
Aux heater	Press the <b>OK</b> button.

### Secondary Interior Heating System Active Indicator



It illuminates when you switch the system on.

### Parking Heater

#### Principle of Operation

The system is designed to provide heat when your vehicle is parked.



# Climate Control

The system warms the engine and the vehicle interior. It uses fuel from the vehicle fuel tank.

**Note:** Make sure the heater exhaust outlet, in front of the right-hand front tire, is free from snow, ice, mud and any other blockages to avoid issues with the heater operation.

## Using the Parking Heater



**WARNING:** We recommend that you have a qualified technician check and repair the heater system after a crash. Failure to follow this instruction could result in personal injury or death.



**WARNING:** Do not use the parking heater at fuel filling stations or near sources of combustible vapors, dust or in enclosed spaces. Failure to follow this instruction could result in personal injury or death.

The system does not operate if the battery charge level is low.

The system only operates when your vehicle is stationary with the engine off.

When you correctly use the system it:

- Keeps the windows clear of thin ice and helps prevent condensation.
- Assists the engine to reach normal operating temperature sooner.

**Note:** If the heater is in the process of stopping, excess fuel in the heater burns out and there is some heat, exhaust and noise.

## Parking Heater Information Messages

Message	Action
Park heater not started Low fuel level	Displays if the parking heater fails to operate due to low fuel level. Refuel as soon as possible.

## Switching Continue Heat On

**Press the menu button on the steering wheel to enter the information display main menu:**

Menu Item	Action
Settings	Press the <b>OK</b> button.
Vehicle	Press the <b>OK</b> button.
Park heater	Press the <b>OK</b> button.
Continue heat	Press the <b>OK</b> button.

# Climate Control

When you switch the ignition off, the heater starts or continues running if conditions permit for up to 30 minutes.

**Note:** You can use this mode to maintain a warm cabin after you switch the ignition off. After the heater completes this mode, the check box in the information display resets to unchecked.

## Setting the Timer

**Press the menu button on the steering wheel to enter the information display main menu:**

Menu Item	Action
Settings	Press the <b>OK</b> button.
Vehicle	Press the <b>OK</b> button.
Park heater	Press the <b>OK</b> button.
Heater programming	Press the <b>OK</b> button.
Activate	Press the <b>OK</b> button.
Once	Press the <b>OK</b> button.
Activate	Press the <b>OK</b> button.
Time one	Press the <b>OK</b> button.
Activate	Press the <b>OK</b> button.
Time two	Press the <b>OK</b> button.
Activate	Press the <b>OK</b> button.

# Climate Control

The system has three different modes, that you can set in the information display.

Timer Mode	Description
Once	Allows you to set one heating cycle for a specific day. If conditions permit, the heater starts up to 40 minutes prior to the set date and time. <sup>1</sup>
Time one	Allows you to program a heating cycle for each day of the week. The time remains stored and the system warms up your vehicle prior to the programmed departure times.
Time two	Allows you to program a second heating cycle for each day of the week. The time remains stored and the system warms up your vehicle prior to the programmed departure times.

<sup>1</sup> You must set the day and time for this mode before you check the box in the information display.

**Note:** The time and date on your vehicle clock must be correctly set.

## Switching the Parking Heater On and Off With the Remote Control

The parking heater transmitter allows you to remotely request the heater to start and run for up to 30 minutes or to stop all heater modes.

**Note:** Up to three transmitters can be paired to your vehicle.

**Note:** The LED light on the remote transmitter does not indicate the actual status of the heater. The light does not guarantee the heater received a signal to start or stop.

**Note:** Electronic devices that operate in the same frequency may affect the range of the transmitter.

Press and hold the **ON** or **HEAT** button on the transmitter until a green LED light illuminates on the transmitter.

Press and hold the **OFF** button on the transmitter until a red LED light illuminates on the transmitter. This applies only for the heater mode running at the present time, so future timer settings or future continue heat settings do not disable.

The following table lists the parking heater remote control indications.

Transmitter LED	Description
Green	The transmitter sent a radio signal.
Flashing green	The transmitter sent a radio signal, but the heater did not receive the signal.
Orange to green	The transmitter sent a radio signal, but the transmitter battery charge is low.

# Climate Control

---

<b>Transmitter LED</b>	<b>Description</b>
Orange to flashing green	The transmitter did not send a radio signal as the transmitter battery charge is low.
Flashing orange	The transmitter battery charge is low.
Red	The transmitter sent a radio signal.
Flashing red	The transmitter sent a radio signal, but the heater did not receive the signal.
Orange to red	The transmitter sent a radio signal, but the transmitter battery charge is low.
Orange to flashing red	The transmitter did not send a radio signal as the transmitter battery charge is low.

# Seats

## SITTING IN THE CORRECT POSITION



**WARNING:** Do not recline the seat backrest too far as this can cause the occupant to slide under the seatbelt, resulting in personal injury in the event of a crash.



**WARNING:** Always sit upright against your seatback with your feet on the floor.



**WARNING:** Do not place objects higher than the top of the seat backrest. Failure to follow this instruction could result in personal injury or death in the event of a sudden stop or crash.

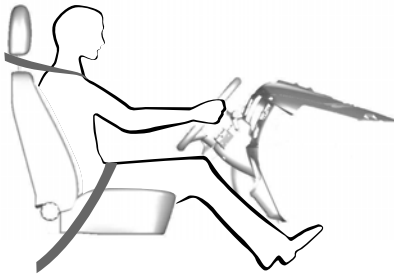

When you use them properly, the seat, head restraint, seatbelt and airbags will provide optimum protection in the event of a crash.

We recommend that you follow these guidelines:

- Sit in an upright position with the base of your spine as far back as possible.
- Do not recline the seat backrest so that your torso is more than 30 degree from the upright position.
- Adjust the head restraint so that the top of it is level with the top of your head and as far forward as possible. Make sure that you remain comfortable.
- Keep sufficient distance between yourself and the steering wheel. We recommend a minimum of 25 cm (10 in) between your breastbone and the airbag cover.
- Hold the steering wheel with your arms slightly bent.
- Bend your legs slightly so that you can press the pedals fully.
- Position the shoulder strap of the seatbelt over the center of your shoulder and position the lap strap tightly across your hips.

Make sure that your driving position is comfortable and that you can maintain full control of your vehicle.

## HEAD RESTRAINTS



**WARNING:** Fully adjust the head restraint before you sit in or operate your vehicle. This will help minimize the risk of neck injury in the event of a crash. Do not adjust the head restraint when your vehicle is moving.



**WARNING:** Raise the rear head restraints when passengers occupy the rear seats.

# Seats



**WARNING:** Do not remove the head restraint from an occupied seat.

## Adjusting the Head Restraints

Adjust the head restraint so that the top of it is level with the top of your head.

### Raising the Head Restraints

1. Pull the head restraint upward.
2. Make sure that the head restraint locks into place.

### Lowering the Head Restraints

1. Press and hold the locking button.
2. Push the head restraint downward.
3. Make sure that the head restraint locks into place.

## Removing the Head Restraints

### Front Head Restraints

1. Recline the seat backrest so that there is enough room for you to remove the head restraint.



E265266

2. Press the locking button and remove the head restraint.

## Rear Head Restraints

1. Fold the seat backrest so that there is enough room for you to remove the head restraint.

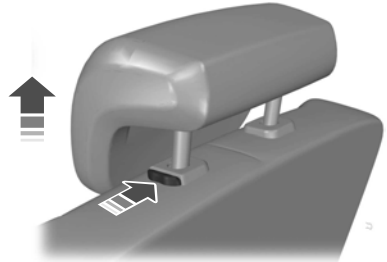

E265267

2. Press the locking button and remove the head restraint.

## MANUAL SEATS - VEHICLES WITH: 2-WAY MANUAL SEAT



**WARNING:** Do not adjust the driver seat when your vehicle is moving.

## Moving the Seat Backward and Forward



**WARNING:** Make sure the seat fully locks into place by rocking it backward and forward. Not securing the seat into the locked position can be dangerous in a crash and could cause serious personal injury or death.

# Seats

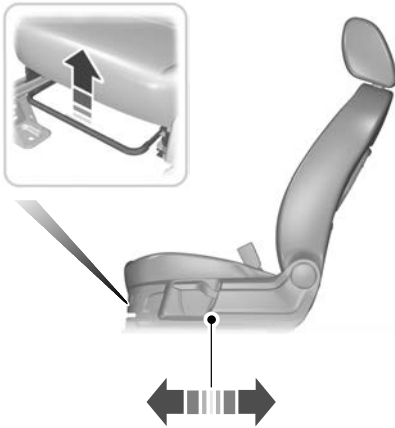

E147926

## Adjusting the Seat Backrest

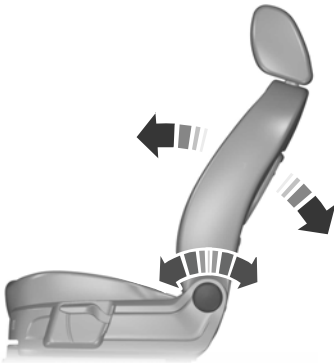

E265553

## MANUAL SEATS - VEHICLES WITH: 4-WAY MANUAL SEAT

**WARNING:** Do not adjust the driver seat when your vehicle is moving.

## Moving the Seat Backward and Forward

**WARNING:** Make sure the seat fully locks into place by rocking it backward and forward. Not securing the seat into the locked position can be dangerous in a crash and could cause serious personal injury or death.

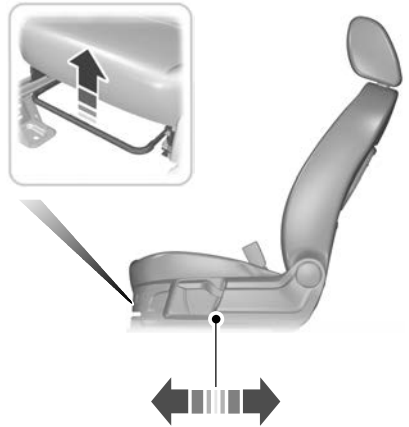

E147926

# Seats

## Adjusting the Seat Backrest

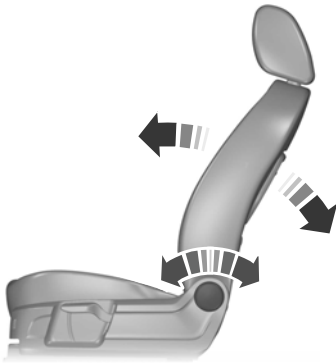

E265553

## Adjusting the Lumbar Support

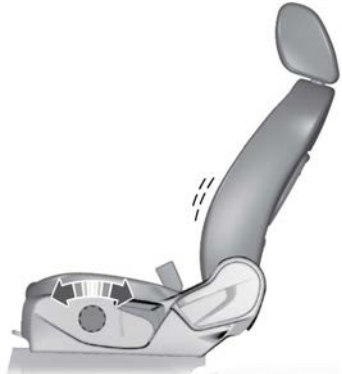

E161564

## Adjusting the Seat Height

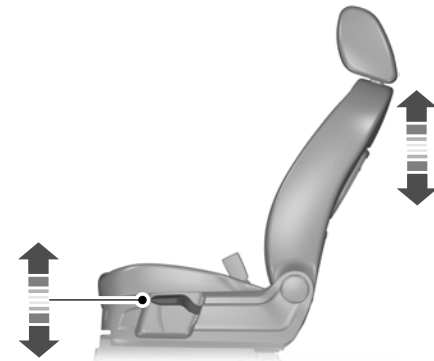

E189042

## MANUAL SEATS - VEHICLES WITH: 6-WAY MANUAL SEAT



**WARNING:** Do not adjust the driver seat when your vehicle is moving.

## Moving the Seat Backward and Forward



**WARNING:** Make sure the seat fully locks into place by rocking it backward and forward. Not securing the seat into the locked position can be dangerous in a crash and could cause serious personal injury or death.



# Seats

## Adjusting the Seat Backrest

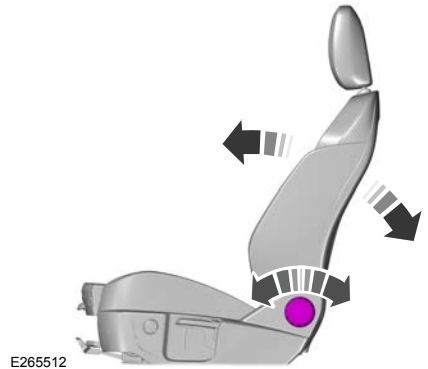
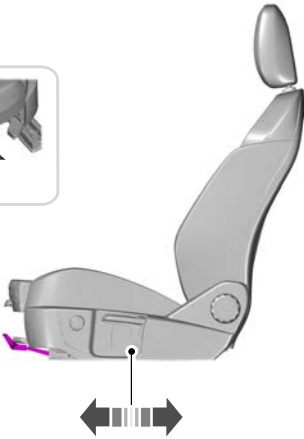

E265512

E265510

## Adjusting the Seat Cushion

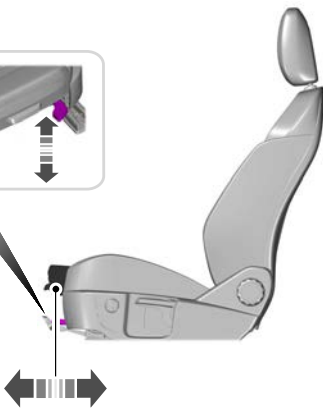
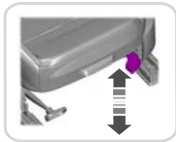

E265511

## Adjusting the Seat Height

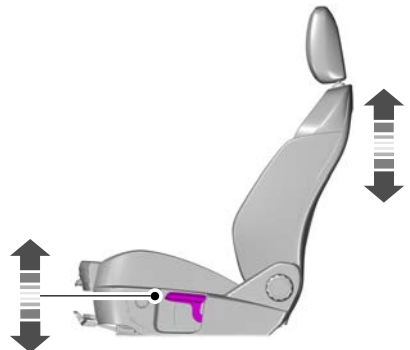

E265513

# Seats

## Adjusting the Lumbar Support

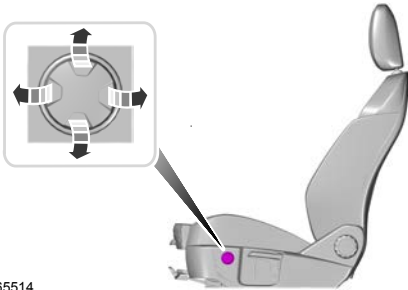

E265514

## POWER SEATS

**⚠ WARNING:** Do not adjust the driver seat or seat backrest when your vehicle is moving. This may result in sudden seat movement, causing the loss of control of your vehicle.

**⚠ WARNING:** Reclining the seatback can cause an occupant to slide under the seat's seatbelt, resulting in severe personal injuries in the event of a crash.

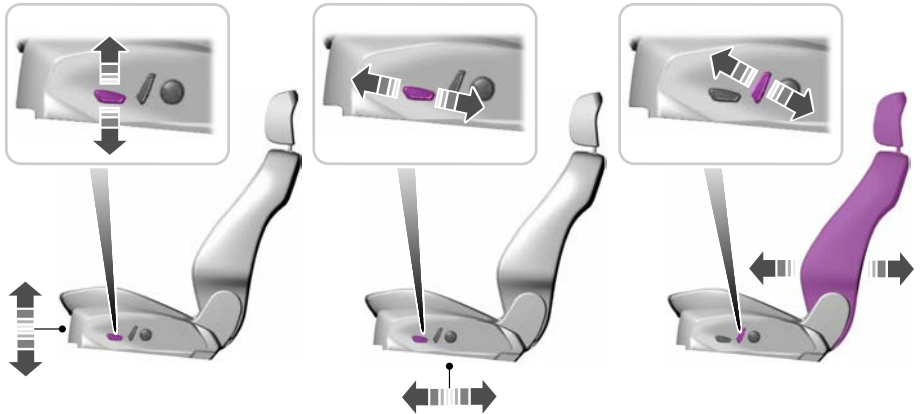

E194195

# Seats

## Power Lumbar

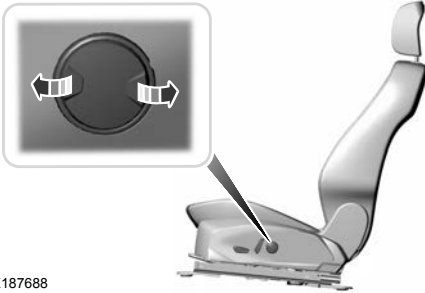

E187688

## REAR SEATS - WAGON

### Folding the Seat Backrests

**WARNING:** Do not fold a seat if it is occupied. Failure to follow this instruction could result in personal injury.

**WARNING:** When folding the seat backrest down, take care not to get your fingers caught in the mechanism.

**WARNING:** Do not use the bench seats as a bed when your vehicle is moving. Failure to follow this warning could result in serious personal injury or death.

**WARNING:** Do not place any objects on a folded seat. Hard objects may become projectiles in a crash or sudden stop, which may increase the risk of serious personal injury.

1. Lower the head restraints. See **Head Restraints** (page 177).

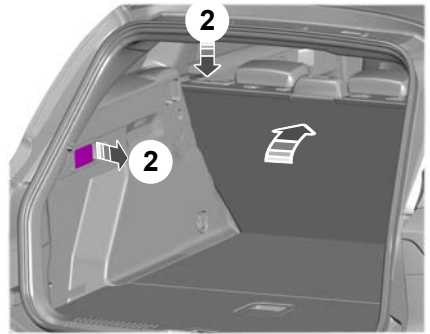

E265931

2. Press and hold the unlock button on the top of the seat or pull the lever on the rear quarter trim panel.
3. Push the seat backrest forward.

**Note:** Do not attempt to fold the rear seat cushion forward.

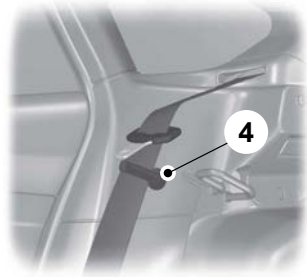

E265248

4. Place the seatbelts in the clips on the trim.

**Note:** Make sure that the seatbelt is fully retracted.

# Seats

## Unfolding the Seat Backrests

**WARNING:** When unfolding the seat backrests, make sure that the seatbelts are not trapped behind the seat.

**WARNING:** Make sure that the seats and the seat backrests are secure and fully locked in their catches.

Lift the seat backrest until it latches in the upright position.

## REAR SEATS - 4-DOOR/5-DOOR

### Folding the Seat Backrests

**WARNING:** When folding the seat backrest down, take care not to get your fingers caught in the mechanism.

**WARNING:** Do not use the bench seats as a bed when your vehicle is moving. Failure to follow this warning could result in serious personal injury or death.

**WARNING:** Do not place any objects on a folded seat. Hard objects may become projectiles in a crash or sudden stop, which may increase the risk of serious personal injury.

1. Lower the head restraints. See **Head Restraints** (page 177).



E265978

2. Press and hold the unlock button.
3. Push the seat backrest forward.

**Note:** Do not attempt to fold the rear seat cushion forward.

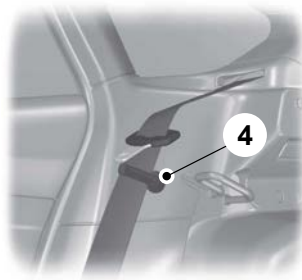

E265248

4. Place the seatbelts in the clips on the trim.

**Note:** Make sure that the seatbelt is fully retracted.

# Seats

## Unfolding the Seat Backrests



**WARNING:** When unfolding the seat backrests, make sure that the seatbelts are not trapped behind the seat.



**WARNING:** Make sure that the seats and the seat backrests are secure and fully locked in their catches.

Lift the seat backrest until it latches in the upright position.

## HEATED SEATS



**WARNING:** Use caution when using the heated seat if you are unable to feel pain to your skin because of advanced age, chronic illness, diabetes, spinal cord injury, medication, alcohol use, exhaustion or other physical conditions. The heated seat could cause burns even at low temperatures, especially if used for long periods of time. Failure to follow this instruction could result in personal injury.



**WARNING:** Do not place anything on the seat that blocks the heat, for example a seat cover or a cushion. This could cause the seat to overheat. Failure to follow this instruction could result in personal injury.



**WARNING:** Do not poke sharp objects into the seat cushion or seat backrest. This could damage the heated seat element and cause it to overheat. Failure to follow this instruction could result in personal injury.

Do not switch the heated seat on if the seat is wet.

The heated seat button is on the climate control assembly.



Repeatedly press the button to adjust the temperature.

# Rear Occupant Alert System (If Equipped)

## WHAT IS THE REAR OCCUPANT ALERT SYSTEM

The rear occupant alert system monitors vehicle conditions and notifies you to check for rear seat occupants when you switch the ignition off.

## HOW DOES THE REAR OCCUPANT ALERT SYSTEM WORK

The system monitors when rear doors have been opened and closed to indicate the potential presence of an occupant in the rear seat.

A message displays in the information and entertainment display screen and an audible warning sounds when you switch the ignition off after any of the following conditions have been met:

- A rear door is opened or closed while the ignition is on.
- You switch the ignition on within 15 minutes of a rear door opening and closing.
- You switch the ignition on within 15 minutes of the alert having displayed or sounded.

## REAR OCCUPANT ALERT SYSTEM PRECAUTIONS



**WARNING:** On hot days, the temperature inside the vehicle can rise very quickly. Exposure of people or animals to these high temperatures for even a short time can cause death or serious heat related injuries, including brain damage. Small children are particularly at risk.



**WARNING:** Do not leave children or pets unattended in your vehicle. Failure to follow this instruction could result in personal injury or death.

## REAR OCCUPANT ALERT SYSTEM LIMITATIONS

The system does not detect the presence of objects or passengers in the rear seat. It monitors when rear doors are opened and closed.

**Note:** *It is possible to receive an alert when there is no rear seat occupant, but alert conditions are met.*

**Note:** *It is possible to receive no alert when there is an occupant in the rear seat, if alert conditions are not met. For example, if a rear seat occupant does not enter the vehicle through a rear door.*

**Note:** *The audible warning does not sound when the front door is opened before you switch the ignition off.*

## SWITCHING REAR OCCUPANT ALERT SYSTEM ON AND OFF

1. Press **Settings** on the touchscreen.
2. Press **Vehicle**.
3. Switch **Rear Occupant Alert** on or off.

**Note:** *The default setting is on.*

**Note:** *Performing a master reset causes the system to switch on again.*

## Semiannual Reminder (If Equipped)

When you switch the system off, a message appears every six months as a reminder that the system is off. You can switch the system back on or leave it off.

## Rear Occupant Alert System (If Equipped)

---

### REAR OCCUPANT ALERT SYSTEM INDICATORS



Message
Check rear seats for occupants.

Displays when you switch your vehicle off after the alert conditions are met.

The message displays for a short period of time. Press **Close** to acknowledge and remove the message.

### REAR OCCUPANT ALERT SYSTEM AUDIBLE WARNINGS

Sounds when you switch your vehicle off after the alert conditions are met.

The warning sounds for a short period of time.

# Auxiliary Power Points



**WARNING:** Do not use a power point for operating a cigar lighter. Incorrect use of the power points can cause damage not covered by the vehicle warranty, and can result in fire or serious injury.

Do not hang any accessory from the accessory plug.

Do not use the power point over the vehicle capacity of 12 volt DC 180 watts or a fuse may blow.

Keep the power point caps closed when not in use.

Do not insert objects other than an accessory plug into the power point.

You can use the power point for up to 75 minutes after you switch the ignition off.

**Note:** When you switch the ignition on, you can use the socket to power 12 volt appliances with a maximum current rating of 15 amps.

To prevent the battery from running out of charge:

- Do not use the power point longer than necessary when the vehicle is not running.
- Do not leave devices plugged in overnight or when you park your vehicle for extended periods.

Power points may be in the following locations:

- On the instrument panel.
- On the rear of the center console.
- Inside the luggage compartment.

## CIGAR LIGHTER



**WARNING:** Do not plug optional electrical accessories into the cigar lighter socket. Incorrect use of the cigar lighter can cause damage not covered by the vehicle warranty, and can result in fire or serious injury.

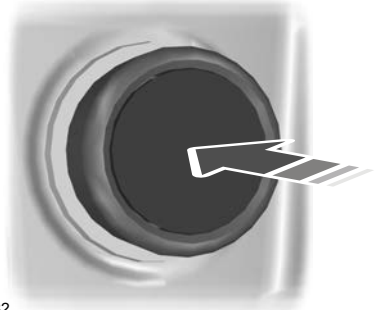

E103382

Press the element in to use the cigar lighter. It pops out after a short period of time.

Do not hold the cigar lighter element pressed in.

**Note:** If the power supply does not work after you switch the ignition off, switch the ignition on.

**Note:** If you use the socket when the engine is not running, the battery may run out of charge.

**Note:** When you switch the ignition on, you can use the socket to power 12 volt appliances with a maximum current rating of 15 amps.



# Wireless Accessory Charger

## LOCATING THE WIRELESS ACCESSORY CHARGER



The charging area is below the climate control.



E265426

## CHARGING A WIRELESS DEVICE



**WARNING:** Wireless charging devices can affect the operation of implanted medical devices, including cardiac pacemakers. If you have any implanted medical devices, we recommend that you consult with your physician.

Place the device within the area shown and with the charging side down to begin charging. The charging stops after your device reaches a full charge.

Make sure the charging area is clean and free from obstruction before charging a device to allow the device to lay flat on the charging area.

The system supports one wireless charging compatible device on the charging area.

**Note:** *Placing the device outside the area shown could affect the charging process.*

**Note:** *Charging time and temperature are dependent on the device used. The system stops charging the device if it reaches a high temperature.*

**Note:** *Devices without built-in Qi standards for wireless charging require an additional Qi receiver or sleeve.*

**Note:** *For compatible devices with built-in Qi wireless charging capability, the charging performance may be affected if your device is in a case. It may be necessary to remove the case to wirelessly charge your device.*

**Note:** *Software and firmware updates to your device could affect the charging operation.*

Do not place items with a magnetic strip, for example passports, parking tickets or credit cards near the charging area when charging a device. This could damage the magnetic strip.

Do not place metal objects, for example remote controls, coins or keys on or near the charging area when charging a device. Metal objects may heat up and degrade the charging performance.

## WIRELESS ACCESSORY CHARGER INDICATORS



Displays on the SYNC status bar when a device is charging.

# Wireless Accessory Charger

---

## WIRELESS ACCESSORY CHARGER – TROUBLESHOOTING

### Wireless Accessory Charger – Information Messages

Message	Action
Wireless charger active	Displays when wireless charging has started.
Charging terminated Phone misaligned or object between phone and charger detected. Correct the condition to resume charging.	Displays when wireless charging has stopped. Remove objects from the charging surface and place phone on center of charging surface.

# Storage Compartments

---

## CUP HOLDERS

**Note:** *Stow items in the cupholder carefully as items may become loose during hard braking, acceleration or crashes, including hot drinks which may spill.*



**WARNING:** Use only soft cups in the cup holders. Hard objects can injure you in a crash.

# Starting and Stopping the Engine

## STARTING AND STOPPING THE ENGINE – PRECAUTIONS



**WARNING:** Exhaust leaks may result in entry of harmful and potentially lethal fumes into the passenger compartment. If you smell exhaust fumes inside your vehicle, have your vehicle inspected immediately. Do not drive if you smell exhaust fumes.



**WARNING:** Extended idling at high engine speeds can produce very high temperatures in the engine and exhaust system, creating the risk of fire or other damage.



**WARNING:** Do not park, idle or drive your vehicle on dry grass or other dry ground cover. The emission system heats up the engine compartment and exhaust system, creating the risk of fire.



**WARNING:** Do not start the engine in a closed garage or in other enclosed areas. Exhaust fumes are toxic. Always open the garage door before you start the engine. Failure to follow this instruction could result in personal injury or death.

If you stop your vehicle and then leave the engine idling for long periods, we recommend that you do one of the following:

- Open the windows at least 3 cm (1 in).
- Set your climate control to outside air.

## IGNITION SWITCH



E247596

**Note:** Make sure the key is clean before inserting it into any lock cylinder.

**Note:** Do not leave the key in the ignition for an extended period of time when the engine is not running. This is to prevent the vehicle battery from losing charge.

### Switching the Ignition Off

Turn the key to position **0**.

### Switching the Ignition to Accessory Mode

Turn the key to position **I**. Electrical accessories, for example the radio, operate without the engine running.

### Switching the Ignition On

Turn the key to position **II**. All electrical circuits and accessories are operational and the warning lamps and indicators illuminate.

# Starting and Stopping the Engine

## Starting the Engine

Turn the key to position **III**. Release the key when the engine starts.

## PUSH BUTTON IGNITION SWITCH



## Switching the Ignition Off

When the ignition is on or in accessory mode, press the push button ignition switch once without your foot on the brake or clutch pedal.

## Switching the Ignition to Accessory Mode

When the ignition is off, press the push button ignition switch once without your foot on the brake or clutch pedal.

All electrical circuits and accessories are operational and the warning lamps and indicators illuminate.

## Starting the Engine

Press the brake or clutch pedal and press the push button ignition switch. An indicator light on the button illuminates when the ignition is on and when the engine starts.

**Note:** *The system may not function if the passive key is close to metal objects or electronic devices, for example keys or a cell phone.*

**Note:** *A valid key must be inside your vehicle to switch the ignition on and start the engine.*

## STARTING THE ENGINE

### Starting a Gasoline Engine - Automatic Transmission, Vehicles Without: Push Button Start

Before starting your vehicle, check the following:

- Make sure that the headlamps and electrical accessories are off.
- Make sure that the parking brake is on.
- Make sure that the transmission is in park (P).

1. Fully press the brake pedal.

**Note:** *Do not touch the accelerator pedal.*



2. Turn the key to position **III**.

**Note:** *The engine may continue cranking for up to 15 seconds or until it starts.*

**Note:** *The engine takes longer to start at lower temperatures. It may crank for several seconds when very cold.*

### Starting a Gasoline Engine - Automatic Transmission, Vehicles With: Push Button Start

Before starting your vehicle, check the following:

- Make sure that the headlamps and electrical accessories are off.
- Make sure that the parking brake is on.
- Make sure that the transmission is in park (P).

1. Fully press the brake pedal.

**Note:** *Do not touch the accelerator pedal.*

# Starting and Stopping the Engine



2. Press the push button ignition switch.

**Note:** The engine may continue cranking for up to 15 seconds or until it starts.

**Note:** The engine takes longer to start at lower temperatures. It may crank for several seconds when very cold.

## Starting a Gasoline Engine - Manual Transmission, Vehicles Without: Push Button Start

Before starting your vehicle, check the following:

- Make sure that the headlamps and electrical accessories are off.
- Make sure that the parking brake is on.
- Make sure that the transmission is in neutral.

1. Fully press the clutch pedal.

**Note:** Do not touch the accelerator pedal.



2. Press the push button ignition switch.

**Note:** The engine may continue cranking for up to 15 seconds or until it starts.

**Note:** The engine takes longer to start at lower temperatures. It may crank for several seconds when very cold.

## Starting a Diesel Engine - Automatic Transmission, Vehicles Without: Push Button Start

Before starting your vehicle, check the following:

- Make sure that the headlamps and electrical accessories are off.
- Make sure that the parking brake is on.
- Make sure that the transmission is in park (P).



2. Turn the key to position **III**.

**Note:** The engine may continue cranking for up to 15 seconds or until it starts.

**Note:** The engine takes longer to start at lower temperatures. It may crank for several seconds when very cold.



# Starting and Stopping the Engine

1. Turn the key to position **II**.

**Note:** Wait until the glow plug indicator turns off.

2. Fully press the brake pedal.

**Note:** Do not touch the accelerator pedal.



3. Turn the key to position **III**.

**Note:** The engine may continue cranking for up to 15 seconds or until it starts.

**Note:** The engine takes longer to start at lower temperatures. It may crank for several seconds when very cold.

## Glow Plug Indicator



If it illuminates, wait until the glow plug indicator turns off before starting the engine.

## Starting a Diesel Engine - Automatic Transmission, Vehicles With: Push Button Start

Before starting your vehicle, check the following:

- Make sure that the headlamps and electrical accessories are off.
- Make sure that the parking brake is on.
- Make sure that the transmission is in park (P).

1. Fully press the brake pedal.

**Note:** Do not touch the accelerator pedal.



2. Press the push button ignition switch.

**Note:** The engine may continue cranking for up to 15 seconds or until it starts.

**Note:** The engine takes longer to start at lower temperatures. It may crank for several seconds when very cold.

## Glow Plug Indicator



The engine does not start until the glow plug indicator turns off. This may take several seconds in extremely cold conditions.

## Starting a Diesel Engine - Manual Transmission, Vehicles Without: Push Button Start

Before starting your vehicle, check the following:

- Make sure that the headlamps and electrical accessories are off.
- Make sure that the parking brake is on.
- Make sure that the transmission is in neutral.

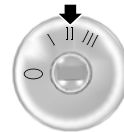

1. Turn the key to position **II**.

**Note:** Wait until the glow plug indicator turns off.

2. Fully press the clutch pedal.

**Note:** Do not touch the accelerator pedal.

# Starting and Stopping the Engine



3. Turn the key to position **III**.

**Note:** The engine may continue cranking for up to 15 seconds or until it starts.

**Note:** The engine takes longer to start at lower temperatures. It may crank for several seconds when very cold.

## Glow Plug Indicator



If it illuminates, wait until the glow plug indicator turns off before starting the engine.

## Starting a Diesel Engine - Manual Transmission, Vehicles With: Push Button Start

Before starting your vehicle, check the following:

- Make sure that the headlamps and electrical accessories are off.
- Make sure that the parking brake is on.
- Make sure that the transmission is in neutral.

1. Fully press the clutch pedal.

**Note:** Do not touch the accelerator pedal.



2. Press the push button ignition switch.

**Note:** The engine may continue cranking for up to 15 seconds or until it starts.

**Note:** The engine takes longer to start at lower temperatures. It may crank for several seconds when very cold.

## Glow Plug Indicator



The engine does not start until the glow plug indicator turns off. This may take several seconds in extremely cold conditions.

## Restarting the Engine After Stopping it - Vehicles With: Push Button Start

The system allows you to start the engine within 10 seconds of switching it off, even if it does not detect a valid passive key.

Within 10 seconds of switching the engine off, fully press the brake or clutch pedal and press the push button ignition switch. After 10 seconds, you can no longer start the engine if the system does not detect a valid passive key.

When you start the engine, it remains running until you press the push button ignition switch, even if your vehicle does not detect a valid passive key. If you open and close a door when the engine is running, the system searches for a valid passive key.

## STOPPING THE ENGINE

### Stopping the Engine When Your Vehicle is Stationary - Automatic Transmission, Vehicles Without: Push Button Start

1. Shift into park (P).
2. Apply the parking brake.
3. Wait until the engine reaches idle speed.



# Starting and Stopping the Engine

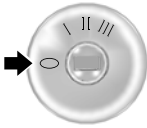

4. Turn the key to position **0**.

## Stopping the Engine When Your Vehicle is Stationary - Automatic Transmission, Vehicles With: Push Button Start

1. Shift into park (P).
2. Apply the parking brake.
3. Wait until the engine reaches idle speed.



4. Press the push button ignition switch.

## Stopping the Engine When Your Vehicle is Stationary - Manual Transmission, Vehicles Without: Push Button Start

1. Shift into neutral.
2. Apply the parking brake.
3. Wait until the engine reaches idle speed.

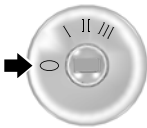

4. Turn the key to position **0**.

## Stopping the Engine When Your Vehicle is Stationary - Manual Transmission, Vehicles With: Push Button Start

1. Shift into neutral.
2. Apply the parking brake.
3. Wait until the engine reaches idle speed.



4. Press the push button ignition switch.

## Stopping the Engine When Your Vehicle is Moving - Automatic Transmission, Vehicles Without: Push Button Start

**⚠ WARNING:** Switching off the engine when your vehicle is still moving results in a significant decrease in braking assistance. Higher effort is required to apply the brakes and to stop your vehicle. A significant decrease in steering assistance could also occur. The steering does not lock, but higher effort could be required to steer your vehicle. When you switch the ignition off, some electrical circuits, for example airbags, also turn off. If you unintentionally switch the ignition off, shift into neutral (N) and restart the engine.

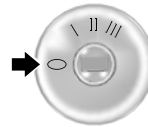

1. Turn the key to position **0**.

# Starting and Stopping the Engine

2. Shift into neutral and use the brakes to bring your vehicle to a safe stop.
3. Shift into park (P).
4. Apply the parking brake.

## Stopping the Engine When Your Vehicle is Moving - Automatic Transmission, Vehicles With: Push Button Start



**WARNING:** Switching off the engine when your vehicle is still moving results in a significant decrease in braking assistance. Higher effort is required to apply the brakes and to stop your vehicle. A significant decrease in steering assistance could also occur. The steering does not lock, but higher effort could be required to steer your vehicle. When you switch the ignition off, some electrical circuits, for example airbags, also turn off. If you unintentionally switch the ignition off, shift into neutral (N) and restart the engine.



1. Press and hold the push button ignition switch until the engine stops, or press it three times within two seconds.
2. Shift into neutral and use the brakes to bring your vehicle to a safe stop.
3. Shift into park (P).
4. Apply the parking brake.

## Stopping the Engine When Your Vehicle is Moving - Manual Transmission, Vehicles Without: Push Button Start



**WARNING:** Switching off the engine when your vehicle is still moving results in a significant decrease in braking assistance. Higher effort is required to apply the brakes and to stop your vehicle. A significant decrease in steering assistance could also occur. The steering does not lock, but higher effort could be required to steer your vehicle. When you switch the ignition off, some electrical circuits, for example airbags, also turn off. If you unintentionally switch the ignition off, shift into neutral (N) and restart the engine.

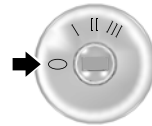

1. Turn the key to position **0**.
2. Shift into neutral and use the brakes to bring your vehicle to a safe stop.
3. Apply the parking brake.

## Stopping the Engine When Your Vehicle is Moving - Manual Transmission, Vehicles With: Push Button Start



**WARNING:** Switching off the engine when your vehicle is still moving results in a significant decrease in braking assistance. Higher effort is required to apply the brakes and to stop your vehicle. A significant decrease in steering assistance could also occur. The

# Starting and Stopping the Engine

steering does not lock, but higher effort could be required to steer your vehicle. When you switch the ignition off, some electrical circuits, for example airbags, also turn off. If you unintentionally switch the ignition off, shift into neutral (N) and restart the engine.



1. Press and hold the push button ignition switch until the engine stops, or press it three times within two seconds.
2. Shift into neutral and use the brakes to bring your vehicle to a safe stop.
3. Apply the parking brake.

## AUTOMATIC ENGINE STOP - VEHICLES WITH: PUSH BUTTON START

### How Does Automatic Engine Stop Work

Automatic engine stop automatically shuts down the vehicle if it has been idling for an extended period. The ignition also turns off to save battery power. Before your vehicle shuts down, a message appears in the information display showing a timer counting down. If you do not intervene within 30 seconds, your vehicle shuts down. Another message appears in the information display to inform you that your vehicle has shut down to save fuel. Start your vehicle as normal.

## Switching Automatic Engine Stop On and Off - Vehicles With: 4.2 Inch Instrument Cluster Display Screen

1. Using the information display controls on the steering wheel, select **Settings**.
2. Select **Vehicle settings**.
3. Switch **30min max idle** on or off.

**Note:** You cannot permanently switch off the automatic shutdown. If you switch it off, it turns on each time you switch the ignition on.

## Switching Automatic Engine Stop On and Off - Vehicles With: 12.3 Inch Instrument Cluster Display Screen

1. Press the menu button on the steering wheel to enter the information display main menu.
2. Select **Settings**.
3. Switch **Auto engine off** on or off.

**Note:** You cannot permanently switch off the automatic shutdown. If you switch it off, it turns on each time you switch the ignition on.

## Overriding Automatic Engine Stop

You can stop the shutdown, or reset the timer, at any point before the 30-second countdown has expired by doing any of the following:

- Pressing the brake or accelerator pedal.
- Pressing the **OK** or **RESET** button during the 30-second countdown.

# Starting and Stopping the Engine

## STARTING AND STOPPING THE ENGINE – TROUBLESHOOTING

### Starting and Stopping the Engine – Warning Lamps



Malfunction Indicator Lamp  
Check Engine

If it illuminates when the engine is running this indicates a malfunction. The On Board Diagnostics system has detected a malfunction of the vehicle emission control system.

If it flashes, engine misfire may be occurring. Increased exhaust gas temperatures could damage the catalytic converter or other vehicle components. Avoid heavy acceleration and deceleration and have your vehicle immediately serviced.



Powertrain Warning Lamp

If it illuminates when the engine is running this indicates a malfunction. If it flashes when you are driving, immediately reduce the vehicle speed. Avoid heavy acceleration and deceleration and have your vehicle immediately serviced.

If both lamps illuminate when the engine is running, stop your vehicle as soon as it is safe to do so. Continuing to drive your vehicle may cause reduced power or the engine to stop. Switch the ignition off and attempt to restart the engine. Have your vehicle immediately checked.

### Starting and Stopping the Engine – Information Messages

Message	Action
Cranking time exceeded	Displays if you exceed the starting time limit. You cannot attempt to start the engine for 15 minutes. If you cannot start the engine after 15 minutes passes, have your vehicle immediately checked.
Starting system malfunction	Displays if you are unable to start your vehicle with a correctly coded key. The system has detected a fault that requires service. Have your vehicle checked as soon as possible.
No key detected	Displays if the system does not detect a valid passive key.

# Starting and Stopping the Engine

## Starting and Stopping the Engine – Frequently Asked Questions - Gasoline, Vehicles Without: Push Button Start

### Why is the engine idle speed high when I am starting the engine?

The speed at which the engine idles immediately after starting is optimized to minimize vehicle emissions and maximize cabin comfort and fuel economy.

### Why does the engine not crank?

You can only attempt to start the engine for a limited amount of time before the starting system temporarily disables. If you exceed the starting time limit, a message may appear and you cannot attempt to start the engine for at least 15 minutes.

### Why do I experience different driving characteristics?

If you disconnect the battery, your vehicle may exhibit some unusual driving characteristics for approximately 8 km (5 mi) after you reconnect it. This is because the engine management system must realign itself with the engine. You can disregard any unusual driving characteristics during this period.

### Why can I not start the engine?

If you cannot start the engine after 3 attempts, wait 10 seconds and do the following:

1. Fully press the brake pedal or the clutch pedal.

**Note:** Make sure that the parking brake is applied.

**Note:** Make sure that the transmission is in park (P) or neutral (N).

2. Fully press the accelerator pedal and hold it there.



3. Turn the key to position III and wait until the engine stops cranking.
4. Release the accelerator pedal.
5. Turn the key to position III.

## Starting and Stopping the Engine – Frequently Asked Questions - Gasoline, Vehicles With: Push Button Start

### Why is the engine idle speed high when I am starting the engine?

The speed at which the engine idles immediately after starting is optimized to minimize vehicle emissions and maximize cabin comfort and fuel economy.

### Why does the engine not crank?

You can only attempt to start the engine for a limited amount of time before the starting system temporarily disables. If you exceed the starting time limit, a message may appear and you cannot attempt to start the engine for at least 15 minutes.

### Why do I experience different driving characteristics?

If you disconnect the battery, your vehicle may exhibit some unusual driving characteristics for approximately 8 km (5 mi) after you reconnect it. This is because the engine management system must realign itself with the engine. You can disregard any unusual driving characteristics during this period.

# Starting and Stopping the Engine

## Why can I not start the engine?

If you cannot start the engine after 3 attempts, wait 10 seconds and do the following:

1. Fully press the brake pedal or the clutch pedal.

**Note:** Make sure that the parking brake is applied.

**Note:** Make sure that the transmission is in park (P) or neutral (N).

2. Fully press the accelerator pedal and hold it there.
3. Press the push button ignition switch.

**Note:** The engine cranks for a short period of time and then it stops.

4. Release the accelerator pedal.



5. Press the push button ignition switch.

## Why does the system not detect a passive key?

If the system does not detect a passive key and you are unable to start the engine, insert the passive key into the backup position and press the push button ignition switch to start the engine. See **Passive Key Backup Position** (page 67).

## Starting and Stopping the Engine – Frequently Asked Questions - Diesel, Vehicles Without: Push Button Start

### Why is the engine idle speed high when I am starting the engine?

The speed at which the engine idles immediately after starting is optimized to minimize vehicle emissions and maximize cabin comfort and fuel economy.

### Why does the engine not crank?

You can only attempt to start the engine for a limited amount of time before the starting system temporarily disables. If you exceed the starting time limit, a message may appear and you cannot attempt to start the engine for at least 15 minutes.

### Why do I experience different driving characteristics?

If you disconnect the battery, your vehicle may exhibit some unusual driving characteristics for approximately 8 km (5 mi) after you reconnect it. This is because the engine management system must realign itself with the engine. You can disregard any unusual driving characteristics during this period.

### Why can I not start the engine?

If you cannot start the engine, do the following:

1. Fully press the brake pedal or the clutch pedal.

**Note:** Make sure that the parking brake is applied.

**Note:** Make sure that the transmission is in park (P) or neutral (N).

# Starting and Stopping the Engine



2. Turn the key to position **III** until the engine starts.

## Starting and Stopping the Engine – Frequently Asked Questions - Diesel, Vehicles With: Push Button Start

### Why is the engine idle speed high when I am starting the engine?

The speed at which the engine idles immediately after starting is optimized to minimize vehicle emissions and maximize cabin comfort and fuel economy.

### Why does the engine not crank?

You can only attempt to start the engine for a limited amount of time before the starting system temporarily disables. If you exceed the starting time limit, a message may appear and you cannot attempt to start the engine for at least 15 minutes.

### Why do I experience different driving characteristics?

If you disconnect the battery, your vehicle may exhibit some unusual driving characteristics for approximately 8 km (5 mi) after you reconnect it. This is because the engine management system must realign itself with the engine. You can disregard any unusual driving characteristics during this period.

### Why can I not start the engine?

If you cannot start the engine, do the following:

1. Fully press the brake pedal or the clutch pedal.

**Note:** Make sure that the parking brake is applied.

**Note:** Make sure that the transmission is in park (P) or neutral (N).



2. Press the push button ignition switch until the engine starts.

### Why does the system not detect a passive key?

If the system does not detect a passive key and you are unable to start the engine, insert the passive key into the backup position and press the push button ignition switch to start the engine. See **Passive Key Backup Position** (page 67).

# Unique Driving Characteristics

---

## HYBRID VEHICLE OPERATION

Your vehicle has a 48 volt mild hybrid system. The system is designed to help reduce fuel consumption and CO<sub>2</sub> emissions by using regenerative charging and stopping the engine when your vehicle is coasting at a speed less than the engine stop speed that you have set. See **Setting the Engine Stop Speed** (page 211).

**Note:** *Regenerative charging results in a greater degree of engine braking. Engine braking further increases following a brake pedal press. This is normal.*



# Auto-Start-Stop - Automatic Transmission

## WHAT IS AUTO-START-STOP

The system is designed to help reduce fuel consumption and CO<sub>2</sub> emissions by stopping the engine when it is idling, for example at traffic lights.

## AUTO-START-STOP PRECAUTIONS



**WARNING:** Apply the parking brake, shift into park (P), switch the ignition off and remove the key before you leave your vehicle. Failure to follow this instruction could result in personal injury or death.



**WARNING:** Apply the parking brake, shift into park (P), switch the ignition off and remove the key before you open the hood or have any service or repair work completed. If you do not switch the ignition off, the engine could restart at any time. Failure to follow this instruction could result in personal injury or death.

## SWITCHING AUTO-START-STOP ON AND OFF

The system turns on when you switch the ignition on.



Press the switch to switch the system off.

**Note:** *OFF* illuminates in the switch.

Press the switch again to switch the system back on.

**Note:** *The system is designed to turn off if it detects a malfunction. If the system malfunctions, have your vehicle checked as soon as possible.*

## STOPPING THE ENGINE

Stop your vehicle, keep your foot on the brake pedal and the transmission in drive (D).

**Note:** *The engine stops when you shift into park (P) or neutral (N) whether you have your foot on the brake pedal or not.*

**Note:** *Power assist steering turns off when the engine stops.*

## RESTARTING THE ENGINE

Release the brake pedal or press the accelerator pedal.

A message appears in the information display if the system requires you to take action.

Message	Condition	Action
Auto StartStop Press brake to start engine	The system needs to restart the engine but requires your confirmation.	Press the brake pedal to restart the engine.
Auto StartStop Press a pedal to start engine	The system needs to restart the engine but requires your confirmation.	Press the brake pedal or the accelerator pedal to restart the engine.

# Auto-Start-Stop - Automatic Transmission

## AUTO-START-STOP INDICATORS



**WARNING:** The system may require the engine to automatically restart when the auto-start-stop indicator illuminates green or flashes amber. Failure to follow this instruction could result in personal injury.



The Auto-Start-Stop indicator illuminates green when the engine stops. It flashes amber and a message appears when you need to take action.



The Auto-Start-Stop indicator illuminates gray with a strikethrough when the system is not available.

**Note:** You can display the reason why the system is not available in the information display.

## AUTO-START-STOP – TROUBLESHOOTING

### Auto-Start-Stop – Information Messages

Message	Condition	Action
Auto StartStop Shift to P Restart engine	The system is not functioning.	Shift into park (P) and restart the engine yourself.
Auto StartStop Manual restart required	The system is not functioning.	Restart the engine yourself.

# Auto-Start-Stop - Automatic Transmission

---

## **Auto-Start-Stop – Frequently Asked Questions**

### **Why does the engine not always stop when I expect it to?**

The system is designed to work in a way that complements other vehicle systems, allowing them to operate at optimum performance.

The system does not stop the engine if:

- The driver door is open.
- The driver seatbelt is unfastened.
- Your vehicle is at high altitude.
- The heated windshield is on.
- The transmission is in manual (M).
- Your vehicle is on a steep grade.
- The engine is warming up.
- The outside temperature is too low or too high.
- The battery charge is low.
- The battery temperature is outside the optimal operating range.
- The engine is required to run to maintain interior climate and reduce fogging.

### **Why does the engine sometimes restart when I do not expect it to?**

The system is designed to work in a way that complements other vehicle systems, allowing them to operate at optimum performance.

The system restarts the engine if:

- You switch the heated windshield on.
- You switch maximum defrost on.
- Your vehicle starts to roll downhill in neutral.

- The engine is required to run to maintain adequate brake system assistance.
- The engine is required to run to maintain interior climate and reduce fogging.

### **Can I permanently switch the system off?**

No. The system plays an important role in reducing the fuel consumption and the CO<sub>2</sub> emissions.

### **Will the frequent engine starts cause parts to wear out?**

Your vehicle has an enhanced battery and starter motor that are designed for the increased number of engine starts.

# Auto-Start-Stop - Manual Transmission, Excluding: Mild Hybrid Electric Vehicle (MHEV)

## WHAT IS AUTO-START-STOP

The system is designed to help reduce fuel consumption and CO<sub>2</sub> emissions by stopping the engine when it is idling, for example at traffic lights.

## AUTO-START-STOP PRECAUTIONS



**WARNING:** Apply the parking brake, shift into neutral, switch the ignition off and remove the key before you leave your vehicle. Failure to follow this instruction could result in personal injury or death.



**WARNING:** Apply the parking brake, shift into neutral, switch the ignition off and remove the key before you open the hood or have any service or repair work completed. If you do not switch the ignition off, the engine could restart at any time. Failure to follow this instruction could result in personal injury or death.

## SWITCHING AUTO-START-STOP ON AND OFF

The system turns on when you switch the ignition on.



Press the switch to switch the system off.

**Note:** *OFF* illuminates in the switch.

Press the switch again to switch the system back on.

**Note:** *The system is designed to turn off if it detects a malfunction. If the system malfunctions, have your vehicle checked as soon as possible.*

## STOPPING THE ENGINE

1. Stop your vehicle.
2. Shift into neutral.
3. Release the clutch pedal and the accelerator pedal.

**Note:** *To obtain maximum benefit from the system, shift into neutral and release the clutch pedal whenever you stop your vehicle for more than three seconds.*

**Note:** *Power assist steering turns off when the engine stops.*

## RESTARTING THE ENGINE

Press the clutch pedal.

A message appears in the information display if the system requires you to take action.

Message	Condition	Action
Auto StartStop Press a pedal to start engine	The system needs to restart the engine but requires your confirmation.	Press the accelerator pedal, brake pedal or clutch pedal to restart the engine.
Auto StartStop Select neutral to start engine	The system needs to restart the engine but cannot because the transmission is in gear.	Shift into neutral to restart the engine.

# Auto-Start-Stop - Manual Transmission, Excluding: Mild Hybrid Electric Vehicle (MHEV)

## AUTO-START-STOP INDICATORS



**WARNING:** The system may require the engine to automatically restart when the auto-start-stop indicator illuminates green or flashes amber. Failure to follow this instruction could result in personal injury.



The Auto-Start-Stop indicator illuminates green when the engine stops. It flashes amber and a message appears when you need to take action.



The Auto-Start-Stop indicator illuminates gray with a strikethrough when the system is not available.

**Note:** You can display the reason why the system is not available in the information display.

## AUTO-START-STOP AUDIBLE WARNING

The Auto-Start-Stop audible warning sounds if you open the driver door when the system has stopped the engine.

## AUTO-START-STOP – TROUBLESHOOTING

### Auto-Start-Stop – Information Messages

Message	Condition	Action
Auto StartStop Manual restart required	The system is not functioning.	Shift into neutral and restart the engine yourself.

# Auto-Start-Stop - Manual Transmission, Excluding: Mild Hybrid Electric Vehicle (MHEV)

---

## Auto-Start-Stop – Frequently Asked Questions

### Why does the engine not always stop when I expect it to?

The system is designed to work in a way that complements other vehicle systems, allowing them to operate at optimum performance.

The system does not stop the engine if:

- The driver door is open.
- Your vehicle is at high altitude.
- The heated windshield is on.
- The engine is warming up.
- The outside temperature is too low or too high.
- The battery charge is low.
- The battery temperature is outside the optimal operating range.
- The engine is required to run to maintain interior climate and reduce fogging.

### Why does the engine sometimes restart when I do not expect it to?

The system is designed to work in a way that complements other vehicle systems, allowing them to operate at optimum performance.

The system restarts the engine if:

- You switch the heated windshield on.
- You switch maximum defrost on.
- Your vehicle starts to roll downhill in neutral.
- The engine is required to run to maintain adequate brake system assistance.
- The engine is required to run to maintain interior climate and reduce fogging.

### Can I permanently switch the system off?

No. The system plays an important role in reducing the fuel consumption and the CO<sub>2</sub> emissions.

### Will the frequent engine starts cause parts to wear out?

Your vehicle has an enhanced battery and starter motor that are designed for the increased number of engine starts.

# Auto-Start-Stop - Mild Hybrid Electric Vehicle (MHEV)

## WHAT IS AUTO-START-STOP

The system is designed to help reduce fuel consumption and CO<sub>2</sub> emissions by stopping the engine when it is idling, for example at traffic lights or when your vehicle is coasting at a speed less than the engine stop speed that you have set. See **Setting the Engine Stop Speed** (page 211). The system is designed to stop the engine when the transmission is in gear or in neutral.

## AUTO-START-STOP PRECAUTIONS



**WARNING:** Apply the parking brake, shift into neutral, switch the ignition off and remove the key before you leave your vehicle. Failure to follow this instruction could result in personal injury or death.



**WARNING:** Apply the parking brake, shift into neutral, switch the ignition off and remove the key before you open the hood or have any service or repair work completed. If you do not switch the ignition off, the engine could restart at any time. Failure to follow this instruction could result in personal injury or death.

## AUTO-START-STOP SETTINGS

### Setting the Engine Stop Speed - Vehicles With: 4.2 Inch Instrument Cluster Display Screen

1. Using the information display controls on the steering wheel, select **Settings**.
2. Select **Vehicle settings**.
3. Select **Rolling StartStop**.

4. Select a setting and press the **OK** button.

### Setting the Engine Stop Speed - Vehicles With: 12.3 Inch Instrument Cluster Display Screen

1. Press the menu button on the steering wheel to enter the information display main menu.
2. Select **Settings**.
3. Select **Vehicle**.
4. Select **Rolling StartStop**.
5. Select a setting and press the **OK** button.

## SWITCHING AUTO-START-STOP ON AND OFF

The system turns on when you switch the ignition on.



Press the switch to switch the system off.

**Note:** **OFF** illuminates in the switch.

Press the switch again to switch the system back on.

**Note:** *The system is designed to turn off if it detects a malfunction. If the system malfunctions, have your vehicle checked as soon as possible.*

## STOPPING THE ENGINE

### Stopping the Engine in Gear

1. Press the brake pedal and slow your vehicle down to 15 km/h (9 mph) or less.

**Note:** *You can set the speed at which the system stops the engine through the information display.*

2. Fully press the clutch pedal.

# Auto-Start-Stop - Mild Hybrid Electric Vehicle (MHEV)

**Note:** Power assist steering remains on when the engine stops.

## Stopping the Engine in Neutral

1. Press the brake pedal and slow your vehicle down to 15 km/h (9 mph) or less.

**Note:** You can set the speed at which the system stops the engine through the information display.

2. Press the clutch pedal and shift into neutral.
3. Release the clutch pedal.

**Note:** Power assist steering remains on when the engine stops.

## RESTARTING THE ENGINE

### Restarting the Engine in Gear

Release the brake pedal.

### Restarting the Engine in Neutral

1. Fully press the clutch pedal.
2. Select a gear.

## AUTO-START-STOP INDICATORS



**WARNING:** The system may require the engine to automatically restart when the auto-start-stop indicator illuminates green or flashes amber. Failure to follow this instruction could result in personal injury.



The Auto-Start-Stop indicator illuminates green when the engine stops. It flashes amber and a message appears when you need to take action.



The Auto-Start-Stop indicator illuminates gray with a strikethrough when the system is not available.

**Note:** You can display the reason why the system is not available in the information display.

## AUTO-START-STOP AUDIBLE WARNING

The Auto-Start-Stop audible warning sounds if you open the driver door when the system has stopped the engine.



# Auto-Start-Stop - Mild Hybrid Electric Vehicle (MHEV)

---

## AUTO-START-STOP – TROUBLESHOOTING

### Auto-Start-Stop – Information Messages

<b>Message</b>	<b>Condition</b>	<b>Action</b>
Auto StartStop Manual restart required	The system is not functioning.	Shift into neutral and restart the engine yourself.
Auto StartStop Select neutral to start engine	The system cannot restart the engine.	Shift into neutral.
Auto StartStop Press clutch to start engine	The system cannot restart the engine.	Fully press the clutch pedal.

# Auto-Start-Stop - Mild Hybrid Electric Vehicle (MHEV)

---

## Auto-Start-Stop – Frequently Asked Questions

### Why does the engine not always stop when I expect it to?

The system is designed to work in a way that complements other vehicle systems, allowing them to operate at optimum performance.

The system does not stop the engine if:

- The driver door is open.
- The driver seatbelt is unfastened.
- The engine is warming up.
- The outside temperature is too low or too high.
- The battery charge is low.
- The battery temperature is outside the optimal operating range.
- The engine is required to run to maintain interior climate and reduce fogging.

### Why does the engine sometimes restart when I do not expect it to?

The system is designed to work in a way that complements other vehicle systems, allowing them to operate at optimum performance.

The system restarts the engine if:

- You switch **MAX A/C** on.
- You switch maximum defrost on.
- Your vehicle starts to roll downhill in neutral.
- The engine is required to run to maintain adequate brake system assistance.
- The engine is required to run to maintain interior climate and reduce fogging.

### Can I permanently switch the system off?

No. The system plays an important role in reducing the fuel consumption and the CO<sub>2</sub> emissions.

### Will the frequent engine starts cause parts to wear out?

Your vehicle has an enhanced battery and starter generator that are designed for the increased number of engine starts.

# Fuel and Refueling

## SAFETY PRECAUTIONS



**WARNING:** Do not overfill the fuel tank. The pressure in an overfilled tank may cause leakage and lead to fuel spray and fire.



**WARNING:** The fuel system may be under pressure. If you hear a hissing sound near the fuel filler inlet, do not refuel until the sound stops. Otherwise, fuel may spray out, which could cause serious personal injury.



**WARNING:** Fuels can cause serious injury or death if misused or mishandled.



**WARNING:** Fuel may contain benzene, which is a cancer-causing agent.



**WARNING:** When refueling always shut the engine off and never allow sparks or open flames near the fuel tank filler valve. Never smoke or use a cell phone while refueling. Fuel vapor is extremely hazardous under certain conditions. Avoid inhaling excess fumes.

Follow these guidelines when refueling:

- Extinguish all smoking materials and any open flames before refueling your vehicle.
- Always switch the engine off before refueling.
- Automotive fuels can be harmful or fatal if swallowed. Fuel is highly toxic and if swallowed can cause death or permanent injury. If fuel is swallowed immediately call a physician, even if no symptoms are immediately apparent. The toxic effects of fuel may not be apparent for hours.

- Avoid inhaling fuel vapors. Inhaling fuel vapor can lead to eye and respiratory tract irritation. In severe cases, excessive or prolonged breathing of fuel vapor can cause serious illness and permanent injury.
- Avoid getting fuel in your eyes. If you splash fuel in your eyes, immediately remove contact lenses (if worn), flush with water for 15 minutes and seek medical attention. Failure to seek proper medical attention could lead to permanent injury.
- Fuels can be harmful if absorbed through the skin. If you splash fuel on your skin, clothing or both, promptly remove contaminated clothing and thoroughly wash your skin with soap and water. Repeated or prolonged skin contact causes skin irritation.
- Be particularly careful if you are taking Antabuse or other forms of Disulfiram for the treatment of alcoholism. Breathing fuel vapors could cause an adverse reaction, serious personal injury or sickness. Immediately call a physician if you experience any adverse reactions.

## FUEL QUALITY - GASOLINE



**WARNING:** Do not mix diesel with gasoline, gasohol or alcohol. This could cause an explosion.



**WARNING:** Do not use leaded gasoline or gasoline with additives containing other metallic compounds, for example manganese-based. They could damage the emission system.

Use minimum 95 octane unleaded gasoline that meets the specification defined by EN 228 or the equivalent national specification.

# Fuel and Refueling

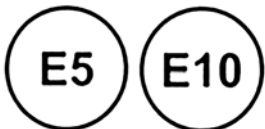

E268502

Your vehicle is suitable for use with ethanol blends up to 10% (E5 and E10).

**Note:** We recommend that you only use high quality fuel. We do not recommend the use of aftermarket fuel additives or other engine treatments.

## Long-Term Storage

Most gasoline contains ethanol. We recommend that you fill the fuel tank with fuel that does not contain ethanol if you intend to store your vehicle for more than two months.

## FUEL QUALITY - DIESEL



**WARNING:** Do not mix diesel with gasoline, gasohol or alcohol. This could cause an explosion.

Use diesel that meets the specification defined by EN 590 or the relevant national specification.



E268503

Your vehicle is suitable for use with biodiesel blends up to 7% (B7).

**Note:** We recommend that you only use high quality fuel. We do not recommend the use of aftermarket fuel additives or other engine treatments.

**Note:** We do not recommend the use of additional additives to prevent fuel waxing.

## Long-Term Storage

Most diesel fuels contain biodiesel. We recommend that you fill the fuel tank with fuel that does not contain biodiesel if you intend to store your vehicle for more than two months.

## FUEL QUALITY - E85

### Choosing the Right Fuel - Flex Fuel Vehicles



**WARNING:** Do not mix diesel with gasoline, gasohol or alcohol. This could cause an explosion.

Do not modify the fuel system configuration or the components in the system. Do not replace the fuel system or the components with parts not specially designed to be used with E85.

Use minimum 95 octane unleaded gasoline that meets the specification defined by EN 228 or the equivalent national specification, or regular unleaded gasoline blended with a maximum of 85% ethanol (E85).



# Fuel and Refueling

Do not use any fuel other than those recommended because they could lead to engine damage that may not be covered by the vehicle Warranty.

**Note:** *We recommend that you use only high quality fuel. Use of any fuel other than those recommended can impair the emission control system and cause a loss of vehicle performance.*

**Note:** *When using E85, your vehicle may have higher fuel consumption.*

Do not use:

- Diesel fuel.
- Fuels containing methanol.
- Fuels containing kerosene or paraffin.
- Fuels containing more than 85% ethanol or E100 fuel.
- Fuels containing metallic-based additives, including manganese-based compounds.
- Fuels containing the octane booster additive, methylcyclopentadienyl manganese tricarbonyl (MMT).
- Leaded fuel (using leaded fuel is prohibited by law).

**Note:** *Flex fuel vehicles can be fueled with gasoline, ethanol or a mixture of both.*

Following a refuel, if the ethanol content of the fuel is different than what you used previously, we recommend that you drive your vehicle immediately for a minimum of 8 km (5 mi) to adapt to the change in ethanol concentration.

- Short stops do not affect the process.
- Do not switch the ignition off.
- Always observe speed limits and road conditions.

The engine control module needs to adapt to the fuel in the tank, especially when refueling more than half a tank.

If you do not follow this procedure, you may experience a minor degradation in engine starting performance and slight fluctuations in engine speed at idle. Until you complete the fuel learning process, these symptoms may continue.

## Long-Term Storage

Most gasoline contains ethanol. We recommend that you fill the fuel tank with fuel that contains low ethanol (E10) if you intend to store your vehicle for more than two months. Alternatively, we recommend that you seek advice from an authorized dealer.

## FUEL FILLER FUNNEL LOCATION

The fuel filler funnel is in the glove compartment or in the spare wheel storage tray.

## RUNNING OUT OF FUEL

Running out of fuel can cause damage not covered by the vehicle Warranty.

If your vehicle runs out of fuel:

- Add a minimum of 5 L (1.1 gal) of fuel to restart the engine.
- You may need to switch the ignition from off to on several times after refueling to allow the fuel system to pump the fuel from the tank to the engine. When restarting, cranking time takes a few seconds longer than normal.

**Note:** *If your vehicle is on a steep slope, more fuel may be required.*

# Fuel and Refueling

## Filling a Portable Fuel Container

**WARNING:** Flow of fuel through a fuel pump nozzle can produce static electricity. This can cause a fire if you are filling an ungrounded fuel container.

Use the following guidelines to avoid electrostatic charge build-up, which can produce a spark, when filling an ungrounded fuel container:

- Only use an approved fuel container to transfer fuel to your vehicle. Place the container on the ground when filling it.
- Do not fill a fuel container when it is inside your vehicle (including the cargo area).
- Keep the fuel pump nozzle in contact with the fuel container when filling it.
- Do not use a device that holds the fuel pump nozzle lever in the fill position.

## Adding Fuel From a Portable Fuel Container

**WARNING:** Do not insert the nozzle of a fuel container or an aftermarket funnel into the fuel filler neck. This may damage the fuel system filler neck or its seal and cause fuel to run onto the ground.

**WARNING:** Do not try to pry open or push open the capless fuel system with foreign objects. This could damage the fuel system and its seal and cause injury to you or others.

**WARNING:** Do not dispose of fuel in the household refuse or the public sewage system. Use an authorized waste disposal facility.

When refueling the vehicle fuel tank from a fuel container, use the fuel filler funnel included with your vehicle. See **Fuel Filler Funnel Location** (page 217).

**Note:** Do not use aftermarket funnels as they may not work with the capless fuel system and can damage it.

When refueling the vehicle fuel tank from a fuel container, do the following:

1. Fully open the fuel filler door.
2. Fully insert the fuel filler funnel into the fuel filler inlet.



3. Add fuel to your vehicle from the fuel container.
4. Remove the fuel filler funnel.
5. Fully close the fuel filler door.
6. Clean the fuel filler funnel and place it back in your vehicle or correctly dispose of it.

**Note:** Extra funnels can be purchased from an authorized dealer if you choose to dispose of the funnel.

# Fuel and Refueling

## REFUELING

### Refueling System Overview

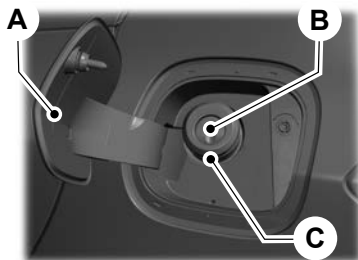

- A Fuel filler door.
- B Fuel tank filler valve.
- C Fuel tank filler pipe.

Your vehicle does not have a fuel tank filler cap.

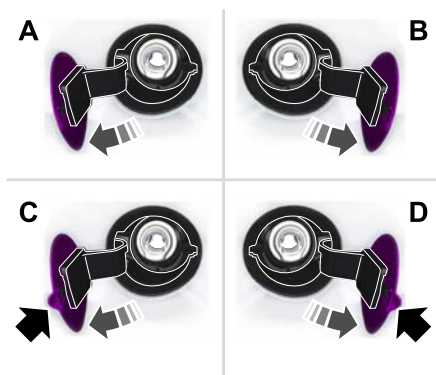

- A Left-hand side. To open the fuel filler door, press the center rear edge of the fuel filler door and then release.
- B Right-hand side. To open the fuel filler door, press the center rear edge of the fuel filler door and then release.
- C Left-hand side. Pull the rear of the fuel filler door to open it.
- D Right-hand side. Pull the rear of the fuel filler door to open it.

### Refueling Your Vehicle

**⚠ WARNING:** When refueling always shut the engine off and never allow sparks or open flames near the fuel tank filler valve. Never smoke or use a cell phone while refueling. Fuel vapor is extremely hazardous under certain conditions. Avoid inhaling excess fumes.

## Fuel and Refueling

**WARNING:** The fuel system may be under pressure. If you hear a hissing sound near the fuel filler inlet, do not refuel until the sound stops. Otherwise, fuel may spray out, which could cause serious personal injury.

**WARNING:** Do not pry open the fuel tank filler valve. This could damage the fuel system. Failure to follow this instruction could result in fire, personal injury or death.

**WARNING:** Do not remove the fuel pump nozzle from its fully inserted position when refueling.

**WARNING:** Stop refueling when the fuel pump nozzle automatically shuts off for the first time. Failure to follow this will fill the expansion space in the fuel tank and could lead to fuel overflowing.

**WARNING:** Do not overfill the fuel tank. The pressure in an overfilled tank may cause leakage and lead to fuel spray and fire.

**WARNING:** Wait at least five seconds before removing the fuel pump nozzle to allow any residual fuel to drain into the fuel tank.

1. Fully open the fuel filler door.
2. Select the correct fuel pump nozzle for your vehicle.

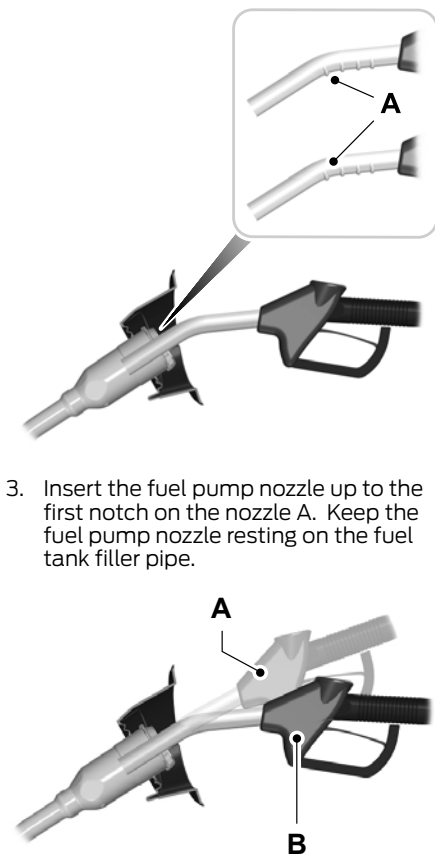

3. Insert the fuel pump nozzle up to the first notch on the nozzle A. Keep the fuel pump nozzle resting on the fuel tank filler pipe.

4. Hold the fuel pump nozzle in position B when refueling. Holding the fuel pump nozzle in position A can affect the flow of fuel and shut off the fuel pump nozzle before the fuel tank is full.

E139203



# Fuel and Refueling

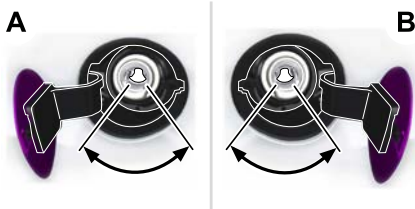

5. Operate the fuel pump nozzle within the area shown.

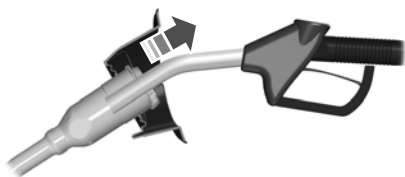

6. When you finish refueling slightly raise the fuel pump nozzle and slowly remove it.
7. Fully close the fuel filler door.

Do not attempt to start the engine if you have filled the fuel tank with incorrect fuel. Incorrect fuel use could cause damage not covered by the vehicle Warranty. Have your vehicle immediately checked.

## Refueling System Warning (If Equipped)

If the fuel tank filler valve does not fully close, a message could appear in the information display.

Message
Check fuel fill inlet

If the message appears, do the following:

1. Stop your vehicle as soon as it is safe to do so and switch the engine off.
2. Shift into park (P) or neutral (N).

3. Apply the parking brake.
4. Fully open the fuel filler door.
5. Check the fuel tank filler valve for any debris that may be restricting its movement.
6. Remove any debris from the fuel tank filler valve.
7. Fully insert a fuel pump nozzle or the fuel filler funnel provided with your vehicle into the fuel filler pipe. See **Fuel Filler Funnel Location** (page 217). This action should dislodge any debris that may be preventing the fuel tank filler valve from fully closing.
8. Remove the fuel pump nozzle or fuel filler funnel from the fuel filler pipe.
9. Fully close the fuel filler door.

**Note:** The message may not immediately reset. If the message continues to appear and a warning lamp illuminates, have your vehicle checked as soon as possible.

## FUEL CONSUMPTION

We derive CO<sub>2</sub> and fuel consumption figures in laboratory tests according to Regulation (EC) 715/2007 or CR (EC) 692/2008 and subsequent amendments.

They are intended as a comparison between makes and models of vehicles. They are not intended to represent the real world fuel consumption you may get from your vehicle.

Real world fuel consumption is governed by many factors, for example driving style, high speed driving, stop-start driving, air conditioning usage, add-on accessories, payload and towing.

# Fuel and Refueling

---

## Advertised Capacity

The advertised capacity is the maximum amount of fuel that you can add to the fuel tank when the fuel gauge indicates empty. See **Capacities and Specifications** (page 476).

In addition, the fuel tank contains an empty reserve. The empty reserve is an unspecified amount of fuel that remains in the fuel tank when the fuel gauge indicates empty.

**Note:** *The amount of fuel in the empty reserve varies and should not be relied upon to increase driving range.*

## Fuel Economy

Your vehicle calculates fuel economy figures through the trip computer average fuel function. See **Trip Computer** (page 147).

The first 1,500 km (1,000 mi) of driving is the break-in period of the engine. A more accurate measurement is obtained after 3,000 km (2,000 mi).

## Impacting Fuel Economy

- Incorrect tire inflation pressures. See **Tire Pressures** (page 457).
- Fully loading your vehicle.
- Carrying unnecessary weight.
- Adding certain accessories to your vehicle such as bug deflectors, rollbars or light bars, running boards and ski racks.
- Using fuel blended with alcohol. See **Fuel Quality** (page 216).
- Fuel economy may decrease with lower temperatures.
- Fuel economy may decrease when driving short distances.
- You may get better fuel economy when driving on flat terrain than when driving on hilly terrain.

# Engine Emission Control

## CATALYTIC CONVERTER - 1.0L ECOBOOST™/1.5L ECOBOOST™/1.5L TIVCT/2.3L ECOBOOST™



**WARNING:** Do not park, idle or drive your vehicle on dry grass or other dry ground cover. The emission system heats up the engine compartment and exhaust system, creating the risk of fire.



**WARNING:** The normal operating temperature of the exhaust system is very high. Never work around or attempt to repair any part of the exhaust system until it has cooled. Use special care when working around the catalytic converter. The catalytic converter heats up to a very high temperature after only a short period of engine operation and stays hot after the engine is switched off.



**WARNING:** Exhaust leaks may result in entry of harmful and potentially lethal fumes into the passenger compartment. If you smell exhaust fumes inside your vehicle, have your vehicle inspected immediately. Do not drive if you smell exhaust fumes.

Your vehicle has various emission control components and a catalytic converter that enables it to comply with applicable exhaust emission standards.

To avoid damaging the catalytic converter:

- Do not crank the engine for more than 10 seconds at a time.
- Do not run the engine with a spark plug lead disconnected.
- Do not push-start or tow-start your vehicle. Use booster cables. See **Jump Starting the Vehicle** (page 390).

- Do not switch the ignition off when your vehicle is moving.
- Do not use leaded fuel.
- Avoid running out of fuel.

**Note:** *Resulting component damage may not be covered by the vehicle Warranty.*

## On-Board Diagnostics System

Your vehicle has an on-board diagnostics system that monitors the emission control system. If any of the following warning lamps illuminate, this may indicate that the on-board diagnostics system has detected an emission control system malfunction.



Continuing to drive your vehicle may cause reduced power or the engine to stop. Failure to respond to a warning lamp may cause component damage not covered by the vehicle Warranty. Have your vehicle checked as soon as possible.

## GASOLINE PARTICULATE FILTER



**WARNING:** Do not park or idle your vehicle over dry leaves, dry grass or other combustible materials. The regeneration process creates very high exhaust gas temperatures and the exhaust will radiate a considerable amount of heat during and after regeneration and after you have switched the engine off. This is a potential fire hazard.

# Engine Emission Control

---

To reduce the risk of causing damage to the gasoline particulate filter:

- Do not crank the engine for more than 10 seconds at a time.
- Do not push-start or tow-start your vehicle. Use booster cables.
- Do not switch the ignition off when your vehicle is moving.
- Do not ignore warning lamps, indicators or information messages.

## Gasoline Particulate Filter Regeneration

Particles in the exhaust gas collect in the gasoline particulate filter causing a gradual restriction over time. This restriction is removed through a regeneration process controlled by the engine control system. The regeneration process converts the particles in the exhaust gas into harmless gases.

Regeneration occurs during normal driving, to varying degrees depending on how you drive. Passive regeneration occurs when you drive at moderate to high speed but if you generally drive short distances at low speed, the engine control system could actively raise the exhaust gas temperature to remove the particles that have collected in the filter to make sure that it continues to correctly operate.

To assist passive regeneration, we recommend that you make occasional journeys that allow you to:

- Drive at a varied range of conditions, including highway conditions for a minimum of 20 minutes.
- Avoid prolonged engine idling.
- Select a suitable gear to maintain engine speed between 1500 and 4000 RPM.

If the filter is saturated or is approaching saturation, a warning lamp illuminates or a message appears in the information display.

**Note:** *A warning lamp illuminates and a message appears in the information display on some vehicles.*

If you do not take action when a warning lamp illuminates or a message appears in the information display, you could cause damage not covered by the vehicle Warranty.

## Gasoline Particulate Filter Warning Lamps and Indicators



Malfunction indicator lamp.

# Engine Emission Control

## Gasoline Particulate Filter Information Messages

Message	Action
Exhaust filter at limit Drive to clean now	<ul style="list-style-type: none"><li>• Drive at a varied range of conditions, including highway conditions for 20 minutes or until the message disappears.</li><li>• Avoid prolonged engine idling.</li><li>• Select a suitable gear to maintain engine speed between 1500 and 4000 RPM.</li></ul>
Exhaust filter over limit Service now	<ul style="list-style-type: none"><li>• Drive at a moderate speed.</li><li>• Avoid heavy acceleration and deceleration.</li><li>• Have your vehicle checked as soon as possible.</li></ul>

## DIESEL PARTICULATE FILTER



**WARNING:** Do not park or idle your vehicle over dry leaves, dry grass or other combustible materials. The regeneration process creates very high exhaust gas temperatures and the exhaust will radiate a considerable amount of heat during and after regeneration and after you have switched the engine off. This is a potential fire hazard.



**WARNING:** The normal operating temperature of the exhaust system is very high. Never work around or attempt to repair any part of the exhaust system until it has cooled. Use special care when working around the diesel oxidation catalytic converter or the diesel particulate filter. The diesel oxidation catalytic converter and the diesel particulate filter heat up to very high temperatures after only a short period of engine operation and remain hot after you switch the engine off.



**WARNING:** Exhaust leaks may result in entry of harmful and potentially lethal fumes into the passenger compartment. If you smell exhaust fumes inside your vehicle, have your vehicle inspected immediately. Do not drive if you smell exhaust fumes.

Your vehicle has various emission control components and a diesel particulate filter that enables it to comply with applicable exhaust emission standards. It filters harmful diesel particulates, for example soot from the exhaust gas.

To avoid damaging the diesel particulate filter:

- Do not crank the engine for more than 10 seconds at a time.
- Do not push-start or tow-start your vehicle. Use booster cables. See **Jump Starting the Vehicle** (page 390).
- Do not switch the ignition off when your vehicle is moving.
- Do not ignore warning lamps or information messages regarding exhaust system cleaning and regeneration.

# Engine Emission Control

**Note:** This could result in damage not covered by the vehicle Warranty.

## On-Board Diagnostics System

Your vehicle has an on-board diagnostics system that monitors the emission control system. If any of the following warning lamps illuminate, this indicates that the on-board diagnostics system has detected an emission control system malfunction.



Engine coolant temperature warning lamp.



Ignition warning lamp.



Malfunction indicator lamp.



Powertrain warning Lamp.



Water in fuel warning lamp.

If you continue to drive your vehicle with a warning lamp illuminated, the engine could stop without warning. This could result in damage not covered by the vehicle warranty. Have your vehicle checked as soon as possible.

## Diesel Particulate Filter Automatic Regeneration



**WARNING:** Do not park or idle your vehicle over dry leaves, dry grass or other combustible materials. The regeneration process creates very high exhaust gas temperatures and the exhaust will radiate a considerable amount of heat during and after regeneration and after you have switched the engine off. This is a potential fire hazard.



**WARNING:** The normal operating temperature of the exhaust system is very high. Never work around or attempt to repair any part of the exhaust system until it has cooled. Use special care when working around the diesel oxidation catalytic converter or the diesel particulate filter. The diesel oxidation catalytic converter and the diesel particulate filter heat up to very high temperatures after only a short period of engine operation and remain hot after you switch the engine off.

The diesel particulate filter on your vehicle requires periodic regeneration to maintain correct operation. The emission control system automatically carries out this process. As soot gathers in the system it begins to restrict the filter. The soot that gathers inside the filter is cleaned in two different ways, passive regeneration and active regeneration. Both methods occur automatically and require no actions from the driver. During automatic regeneration, the system cleans the diesel particulate filter by oxidizing the soot. Cleaning happens during normal engine operating conditions at varying levels depending on driving conditions.



Diesel particulate filter warning lamp.

If the diesel particulate filter is near or at saturation, a warning lamp or information message appears in the information display. Drive your vehicle in a manner to allow effective diesel particulate filter cleaning.

The warning lamp continues to illuminate until the automatic regeneration process completes. Continue to drive your vehicle in a manner to allow effective diesel particulate filter cleaning until the warning lamp turns off.

# Engine Emission Control

Failure to carry out regeneration when required could result in a clogged diesel particulate filter. If the diesel particulate filter fills beyond the regeneration threshold, the system disables the ability to carry out regeneration. This could result in damage not covered by the vehicle warranty.

Where vehicle use meets any of the following conditions:

- Driving short distances.
- Prolonged engine idling.
- Frequently switching the engine on and off.
- High levels of acceleration and deceleration.

We recommend you assist the regeneration process by:

- Avoiding prolonged engine idling.
- Drive your vehicle in a manner to allow effective cleaning. Drive at a steady vehicle speed of 48 km/h (30 mph) or above for approximately 20 minutes.



If the soot load in the diesel particulate filter reaches a critical level, the malfunction indicator lamp illuminates with the diesel particulate filter warning message. A service regeneration must be performed to recover the particulate filter. Have your vehicle checked as soon as possible to prevent further damage.

Automatic regeneration raises the exhaust temperature to eliminate the soot particles. During cleaning, soot particles are converted to harmless gasses. Once cleaned, the diesel particulate filter continues to trap harmful diesel particles.

If you are driving your vehicle in a manner that allows effective cleaning, a message may appear in the information display to indicate automatic regeneration is in progress.

If you are not driving your vehicle in a manner that allows effective cleaning, a message may appear in the information display to instruct you to drive in a manner that allows automatic regeneration.

The automatic regeneration process is most effective when you drive at a steady vehicle speed of 48 km/h (30 mph) or above for approximately 20 minutes. The frequency and duration of the regeneration process varies by how you drive your vehicle, the outside air temperature and altitude. Frequency varies between 160 km (100 mi) and 500 km (310 mi) and each regeneration process lasts between 10 and 20 minutes.

**Note:** *Changes in the engine or exhaust sound may be heard during the regeneration process.*

**Note:** *During regeneration at low speed or engine idle, you could smell a hot metallic odor and could notice a clicking metallic sound. This is due to the high temperatures reached during the regeneration process. This is normal.*

# Selective Catalytic Reduction System

## WHAT IS THE SELECTIVE CATALYTIC REDUCTION SYSTEM

Selective catalytic reduction is an engine emission control system that reduces exhaust emission levels by injecting AdBlue® into the exhaust system.

## SELECTIVE CATALYTIC REDUCTION SYSTEM PRECAUTIONS



**WARNING:** Keep AdBlue® out of reach of children. Avoid contact with skin, eyes or clothing. In case of contact with your eyes, immediately flush with water and get prompt medical attention. In case of contact with your skin, immediately clean with soap and water. If you swallow any AdBlue®, drink plenty of water and immediately seek medical attention.



**WARNING:** Only refill the AdBlue® tank in a well-ventilated area. When you remove the AdBlue® tank filler cap or an AdBlue® container cap, ammonia vapors may escape. Ammonia vapors can be irritating to skin, eyes and mucous membranes. Inhaling ammonia vapors can cause burning to the eyes, throat and nose and cause coughing and watery eyes.



**WARNING:** Tampering with or disabling the selective catalytic reduction system results in severe vehicle performance limitation including eventual speed limiting to 8 km/h (5 mph).



**WARNING:** The AdBlue® must be refilled when low or replaced when contaminated or your vehicle speed becomes limited to 80 km/h (50 mph). In these conditions, drive with caution and immediately refill the AdBlue® tank. If the AdBlue® tank becomes empty or the fluid contaminated and it is not replaced, your vehicle becomes limited to engine idle only once stopped. In these conditions, be cautious where you stop your vehicle because you may not be able to drive long distances or maintain highway speeds until you refill or replace the fluid.

Do not dilute the AdBlue® with water or any other liquid.

Do not put AdBlue® in the vehicle fuel tank. This can cause engine damage not covered by the vehicle Warranty.

Do not put fuel or any additives in the AdBlue® tank. This can cause damage not covered by the vehicle Warranty.

Do not overfill the AdBlue® tank.

Immediately remove any residue on painted surfaces when filling with AdBlue®.

## SELECTIVE CATALYTIC REDUCTION SYSTEM REQUIREMENTS

Only use AdBlue® certified to ISO-22241.

## SELECTIVE CATALYTIC REDUCTION SYSTEM GUIDELINES

- Do not re-use an empty fluid container.
- Do not store the AdBlue® container in direct sunlight.



# Selective Catalytic Reduction System

- Store the AdBlue® at temperatures between -5°C (23°F) and 20°C (68°F).
- Do not store AdBlue® containers in your vehicle.
- AdBlue® is non-flammable, non-toxic, colorless and water-soluble.



E204215

The AdBlue® tank filler pipe is next to the fuel tank filler pipe and has a blue cap. Fill the tank using a fluid pump at an AdBlue® filling station or an AdBlue® container.

## FILLING THE SELECTIVE CATALYTIC REDUCTION SYSTEM TANK

### Filling the Selective Catalytic Reduction System Tank in Cold Weather

AdBlue® may freeze when the temperature is below -11°C (12°F). Your vehicle has a preheating system which allows the fluid to operate below -11°C (12°F). If you overfill the AdBlue® tank and the fluid freezes, it may cause damage not covered by the vehicle Warranty.

**Note:** It may not be possible to fully fill the AdBlue® tank when the temperature is below -11°C (12°F).

**Note:** If the AdBlue® tank is frozen, it could not correctly display the fluid level or recognize when you fill the tank. The AdBlue® level updates when the tank completely thaws out.

### Filling the Selective Catalytic Reduction System Tank Using a Fuel Station Pump

Filling the AdBlue® tank using a fuel station pump is similar to refueling your vehicle.

1. Fully open the fuel filler door.

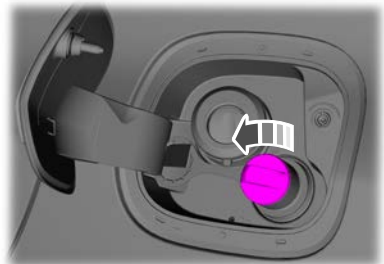

E268809

# Selective Catalytic Reduction System

2. Remove the AdBlue® tank filler cap.
3. Fully insert the AdBlue® pump nozzle.

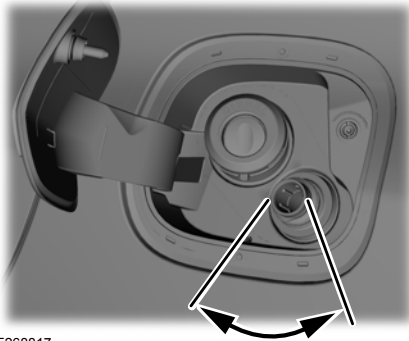

E268817

4. Operate the AdBlue® pump nozzle within the area shown.

**Note:** The pump nozzle shuts off when the tank is full.

5. Slightly raise the AdBlue® pump nozzle and then slowly remove it.
6. Replace the AdBlue® tank filler cap. Turn it clockwise until you feel a strong resistance and it clicks.

Do not attempt to start the engine if you have filled the AdBlue® tank with incorrect fluid. Incorrect fluid use could cause damage not covered by the vehicle Warranty. Have your vehicle checked as soon as possible.

## Filling the Selective Catalytic Reduction System Tank Using a Portable Container

Use containers that have a seal on the spout.

Always follow the manufacturer's instructions.

1. Remove the fluid container cap.

2. Place the spout on to the container and tighten it until you feel a strong resistance.

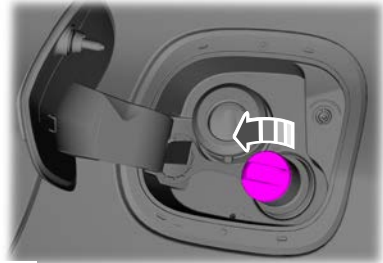

E268809

3. Remove the AdBlue® tank filler cap.
4. Insert the spout into the AdBlue® tank filler pipe until the seal on the spout fully seats.

5. Pour the fluid into the tank.

**Note:** The fluid stops flowing when the tank is full.

6. Return the container to the vertical position slightly below the AdBlue® tank filler pipe.
7. Allow any fluid remaining in the spout to drain back into the container.
8. Remove the spout from the AdBlue® tank filler pipe.
9. Remove the spout from the AdBlue® container and replace the cap.
10. Replace the AdBlue® tank filler cap. Turn it clockwise until you feel a strong resistance and it clicks.

Do not attempt to start the engine if you have filled the AdBlue® tank with incorrect fluid. Incorrect fluid use could cause damage not covered by the vehicle Warranty. Have your vehicle checked as soon as possible.

# Selective Catalytic Reduction System

## CHECKING THE SELECTIVE CATALYTIC REDUCTION FLUID LEVEL - VEHICLES WITH: 4.2 INCH INSTRUMENT CLUSTER DISPLAY SCREEN

1. Using the information display controls on the steering wheel, select **Settings**.
2. Select **Information**.
3. Select **DEF gauge**.

## CHECKING THE SELECTIVE CATALYTIC REDUCTION FLUID LEVEL - VEHICLES WITH: 12.3 INCH INSTRUMENT CLUSTER DISPLAY SCREEN

1. Press the menu button on the steering wheel to enter the information display main menu.

2. Select **Select screens**.
3. Select **AdBlue® info**.

## SELECTIVE CATALYTIC REDUCTION FLUID CONSUMPTION

AdBlue® consumption is directly related to fuel consumption and is governed by many factors, for example driving style, high speed driving, stop-start driving, air conditioning usage, add-on accessories, payload and towing. The AdBlue® consumption may vary between 1% and 6% of the fuel consumption.

AdBlue® consumption is specified for a vehicle variant and not for a single car.

## ADBLUE® CAPACITY AND SPECIFICATION

### Capacities

Variant	Quantity
All.	10.4 L (2.3 gal)

### Materials

Name	Specification
AdBlue® HAMJ-M99C130-xx	WSS-M99C130-A

# Selective Catalytic Reduction System

## SELECTIVE CATALYTIC REDUCTION SYSTEM – TROUBLESHOOTING

### Selective Catalytic Reduction System – Warning Lamps



The warning lamp illuminates if the system detects the fluid level is low or if there is a system

malfunction.

If the warning lamp illuminates, the information display messages give you an indication whether the concern is fluid related or if there is a selective catalytic reductant system malfunction. If the warning lamp illuminates when your vehicle is moving, and the fluid is at a sufficient level, this indicates a system malfunction. Have your vehicle checked as soon as possible.

## Selective Catalytic Reduction System – Information Messages

### AdBlue® Level

Message	Action
AdBlue® low Range : XXXX km Refill soon  AdBlue® low Range : XXXX mls Refill soon	Indicates the approximate distance remaining before the AdBlue® tank becomes empty. Refill the AdBlue® tank as soon as possible.
AdBlue® low No engine start in XXXX km  AdBlue® low No engine start in XXXX mls	Indicates the approximate distance remaining before the AdBlue® tank becomes empty. The engine would not restart if you switch the ignition off. Refill the AdBlue® tank as soon as possible.
AdBlue® level empty. Refill to start engine	The AdBlue® tank is empty. The engine would not restart if you switch the ignition off. Refill the AdBlue® tank. The minimum AdBlue® refill quantity required to restart the engine is available in the information display.

**Note:** When filling the AdBlue® tank from empty, there may be a short period before the increased AdBlue® level is registered.

**Note:** If the AdBlue® tank freezes at low level, the displayed remaining distance could be reduced.

# Selective Catalytic Reduction System

---

## AdBlue® Malfunction

<b>Message</b>	<b>Action</b>
AdBlue® system malfunction Service required	The system has malfunctioned. Have your vehicle checked as soon as possible.
AdBlue® system No engine start in XXXX km AdBlue® system No engine start in XXXX mls	Indicates the approximate distance before a detected system fault would restrict the engine from starting. The engine would not restart if you switch the ignition off. Have your vehicle checked as soon as possible.
AdBlue® system Service required to start engine	The system has malfunctioned. Have your vehicle checked as soon as possible.

# Selective Catalytic Reduction System

---

## Selective Catalytic Reduction System – Frequently Asked Questions

### What is that noise after switching off the engine?

- When you switch off the engine the selective catalytic reduction system pump runs for a short period of time. This is normal.

# Manual Transmission

## MANUAL TRANSMISSION PRECAUTIONS

Do not rest your hand on the gearshift lever or use the gearshift lever to hang and support objects. This could cause damage to the transmission not covered by the vehicle Warranty.

Do not rest your foot on the clutch pedal or use the clutch pedal to keep your vehicle stationary when waiting on a hill. This could cause damage to the clutch not covered by the vehicle Warranty.

Failure to fully press the clutch pedal could cause increased shift efforts, prematurely wear transmission components or damage to the transmission.

## SHIFTING INTO REVERSE

Do not shift into reverse when your vehicle is moving. This could cause damage to the transmission not covered by the vehicle Warranty.

1. Fully press the brake pedal.
2. Fully press the clutch pedal and shift into neutral.

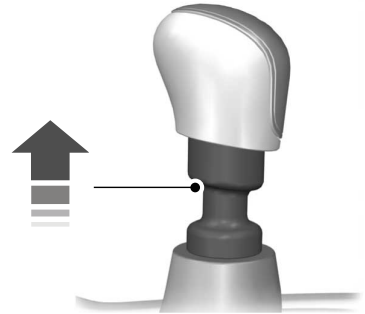

3. Raise the collar and shift into reverse.

## MANUAL TRANSMISSION SHIFT INDICATORS



It illuminates to advise you that shifting gear may give better fuel economy or lower emissions.

## CHECKING THE CLUTCH FLUID LEVEL

The clutch and brake systems share the same fluid reservoir. See **Brake Fluid Check** (page 427).

## CLUTCH FLUID SPECIFICATION

Only use fluid that meets Ford specifications.

# Manual Transmission

---

## Materials

Name	Specification
Brake Fluid DOT 4 LV High Performance BU7J-M6C65-xxxx	WSS-M6C65-A2

## MANUAL TRANSMISSION – TROUBLESHOOTING

### Manual Transmission – Frequently Asked Questions

#### What should I do if any gear is not fully engaged?

Fully press the clutch pedal and shift into neutral. Release the clutch pedal for a moment, fully press the clutch pedal again and shift into gear.



# Automatic Transmission

## AUTOMATIC TRANSMISSION PRECAUTIONS



**WARNING:** Do not apply the brake pedal and accelerator pedal simultaneously. Applying both pedals simultaneously for more than a few seconds will limit engine performance, which may result in difficulty maintaining speed in traffic and could lead to serious injury.



**WARNING:** When your vehicle is stationary, keep the brake pedal fully pressed when shifting gears. Failure to follow this instruction could result in personal injury, death or property damage.



**WARNING:** Apply the parking brake, shift into park (P), switch the ignition off and remove the key before you leave your vehicle. Failure to follow this instruction could result in personal injury or death.

## AUTOMATIC TRANSMISSION POSITIONS

### Park (P)

In park (P), power is not transmitted to the driven wheels and the transmission is locked. You can start the engine with the transmission in this position.

Shift into park (P) only when your vehicle is stationary.

### Reverse (R)

Shift into reverse (R) only when your vehicle is stationary and the engine is at idle speed.

### Neutral (N)

In neutral (N), power is not transmitted to the driven wheels but the transmission is not locked. In neutral (N) your vehicle has the ability to roll freely. You can start the engine with the transmission in this position.

### Drive (D)

Drive (D) is the normal position for driving.

### Low (L) - Vehicles Without: Paddle Shifters

Low (L) provides maximum engine braking.

**Note:** In order to activate low (L) your vehicle must be in drive (D).

**Note:** You can shift into low (L) at any vehicle speed.

### Manual (M) - Vehicles With: Paddle Shifters

Manual (M) provides permanent manual control of the gear selection.

**Note:** In order to activate manual (M) your vehicle must be in drive (D).

**Note:** You can shift into manual (M) at any vehicle speed.

## AUTOMATIC TRANSMISSION POSITION INDICATORS - VEHICLES WITHOUT: PADDLE SHIFTERS

**P R N D L**

The instrument cluster displays the current position.

# Automatic Transmission

## AUTOMATIC TRANSMISSION POSITION INDICATORS - VEHICLES WITH: PADDLE SHIFTERS

**P R N D M**

The instrument cluster displays the current position.

## AUTOMATIC TRANSMISSION SHIFT INDICATORS - VEHICLES WITH: PADDLE SHIFTERS



Shift indicators illuminate when shifting gear is recommended.



## MANUALLY SHIFTING GEARS - VEHICLES WITH: PADDLE SHIFTERS

### Shifting Using the Paddle Shifters

You can only manually shift gears in drive (D) or manual (M).

## Manually Shifting Gears in Drive (D)



Pull any paddle to switch the feature on.

- Pull the right paddle (+) to upshift.
- Pull the left paddle (-) to downshift.

**Note:** The feature turns off if neither paddle is pulled within a short period of time.

**Note:** Hold the right paddle for a few seconds to turn off the feature manually.

## Manually Shifting Gears in Manual (M)



- Pull the right paddle (+) to upshift.
- Pull the left paddle (-) to downshift.

Shift into drive (D) to switch the feature off.

# Automatic Transmission

## STAY IN NEUTRAL MODE - 8-SPEED AUTOMATIC TRANSMISSION

### What Is Stay in Neutral Mode

This mode keeps your vehicle in neutral (N) when you switch your vehicle off.

Use this mode if you exit your vehicle or switch your vehicle off at an automatic car wash.

**Note:** Do not tow your vehicle in this mode.

**Note:** Automatic Return to Park is delayed when your vehicle is in this mode.

### Stay in Neutral Mode Precautions

Do not tow your vehicle in this mode. Failure to follow these instructions could result in vehicle damage not covered by the vehicle warranty.

Your vehicle could shift to park (P) after 30 minutes, or when the vehicle battery charge level is low. Prolonged use of this mode can cause the vehicle battery to run out of charge.

### Entering Stay in Neutral Mode

1. Power your vehicle on.
2. Bring your vehicle to a complete stop.
3. Press and hold the brake pedal.
4. Shift into neutral (N).

**Note:** An instructional message appears.

5. Press the low (L) or manual (M) button.

**Note:** A confirmation message appears when your vehicle enters stay in neutral mode and the neutral (N) button on the transmission selector flashes.

6. Release the brake pedal.

**Note:** Your vehicle is free to roll.

7. Switch your vehicle off.

**Note:** Do not tow your vehicle in this mode.

### Entering Stay in Neutral Mode - Failure to Start

Use this feature to move the transmission selector out of park (P) if you cannot start the engine.

**Note:** This feature does not function if the vehicle battery charge is low.

1. Power your vehicle on without your foot on the brake pedal.
2. Fully press the brake pedal. Keep the brake pedal fully pressed.
3. Fully press the accelerator pedal. Keep the accelerator pedal fully pressed.
4. Shift from park (P) to neutral (N).
5. Press the manual (M) or low (L) button.
6. Attempt to start your vehicle.

**Note:** A confirmation message appears when your vehicle enters stay in neutral mode and the neutral (N) button on the transmission selector flashes.

7. Release the accelerator and brake pedals.

**Note:** Your vehicle is free to roll.

8. Switch your vehicle off.

**Note:** The transmission returns to park (P) if the vehicle battery charge is low.

### Exiting Stay in Neutral Mode

1. Press the brake pedal.
2. Shift into park (P), or power the vehicle on and shift to drive (D) or reverse (R).

# Automatic Transmission

## AUTOMATIC RETURN TO PARK (P) - 8-SPEED AUTOMATIC TRANSMISSION

### What Is Automatic Return to Park (P)

Your vehicle shifts into park (P) if you attempt to exit your vehicle without the transmission in park (P).

### How Does Automatic Return to Park (P) Work

Your vehicle shifts to park (P) when your vehicle is stationary and any of the following occur:

- You switch the vehicle off.
- You open the driver door with the driver seatbelt unfastened.
- You unfasten the driver seatbelt with the driver door open.

**Note:** Do not use Automatic Return to Park when your vehicle is moving, except in an emergency.

### Automatic Return to Park (P) Limitations

Automatic return to park may not work if the door ajar switch is malfunctioning.

See an authorized dealer if any of the following occur:

- Door ajar indicator does not illuminate with the driver door open.
- Door ajar indicator illuminates with the driver door closed.
- Transmission not in park message appears with the driver door closed, after you shift out of park (P).

## BRAKE SHIFT INTERLOCK - 6-SPEED AUTOMATIC TRANSMISSION

### What Is Brake Shift Interlock

Brake shift interlock prevents you from shifting out of park (P) when you have switched the ignition on and not pressed the brake pedal.

### Brake Shift Interlock Precautions



**WARNING:** Do not drive your vehicle until you verify that the stoplamps are working.



**WARNING:** When doing this procedure, you need to take the transmission out of park (P) which means your vehicle can roll freely. To avoid unwanted vehicle movement, always fully apply the parking brake prior to doing this procedure. Use wheels chocks if appropriate.



**WARNING:** If the parking brake is fully released, but the brake warning lamp remains illuminated, the brakes may not be working properly. Have your vehicle checked as soon as possible.

In the event of an electrical malfunction, it is possible that a fuse has blown or the stoplamps are not working. See **Fuse Specification Chart** (page 397).

If the vehicle battery has no charge, jump start your vehicle. See **Jump Starting the Vehicle** (page 390).

# Automatic Transmission

## Using Brake Shift Interlock

Use the brake shift interlock lever to move the selector lever out of park (P) if you cannot start the engine.

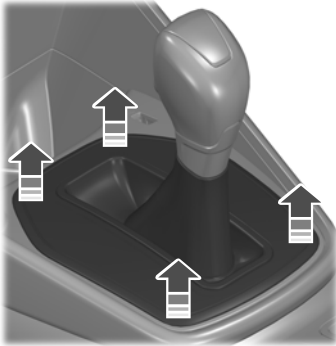

E269819

1. Remove the panel.

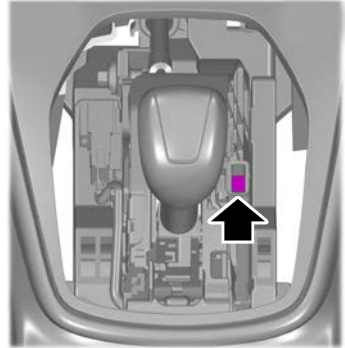

2. Locate the access hole.
3. Using a flat-bladed screwdriver, push the brake shift interlock lever toward the front of your vehicle and hold it there.
4. Move the selector lever from park (P) to neutral (N).
5. Install the panel.
6. Press the brake pedal, start the engine and release the parking brake.

## AUTOMATIC TRANSMISSION AUDIBLE WARNINGS

### Transmission Not in Park (P) Audible Warning

Sounds when you open the driver door and you have not moved the transmission selector to park (P).

# Automatic Transmission

## AUTOMATIC TRANSMISSION – TROUBLESHOOTING

### Automatic Transmission – Information Messages

Message	Description
Transmission malfunction Service now	The system has detected a fault that requires service. Have your vehicle checked as soon as possible.
Transmission limited function See manual	The transmission has limited functionality. The system has detected a fault that requires service. Have your vehicle checked as soon as possible.
Transmission too hot Press brake Transmission over-heating Stop safely	The transmission is overheating and needs to cool. Stop your vehicle as soon as it is safe to do so, leave the engine running and allow the transmission to cool. Wait until the message disappears.
Transmission not in Park	Displays as a reminder to shift into park (P).
Shift malfunction Confirm park brake Apply before exiting the vehicle	Displays when there is a system fault and the park brake needs to be depressed before exiting the vehicle. See your authorized dealer.
Select M to confirm Stay in neutral mode	Displays when you shift into neutral (N).
Select L to confirm Stay in neutral mode	Displays when you shift into neutral (N).
Stay in neutral mode engaged	Displays to confirm that your vehicle has entered Stay in Neutral Mode.

# Electronic Limited-Slip Differential

---

## ELECTRONIC LIMITED-SLIP DIFFERENTIAL – TROUBLESHOOTING

### Electronic Limited-Slip Differential – Information Messages

<b>Message</b>	<b>Description</b>
Check electronic limited slip differential	The system has malfunctioned. Have your vehicle checked as soon as possible.
Electronic limited slip differential off See Owner's Manual	The system has malfunctioned. Have your vehicle checked as soon as possible.
Electronic limited slip differential temporarily disabled	The system temporarily turns off. This could be due to an undersized spare tire or caused by the system overheating. If an undersized spare tire is installed, replace the spare tire with a full-sized tire as soon as possible. If an undersized spare tire is not installed, stop your vehicle as soon as it is safe to do so and allow the system to cool.
Electronic limited slip differential restored to normal	The system resumes normal function.

# Brakes

## GENERAL INFORMATION

**Note:** Occasional brake noise is normal. If a metal-to-metal, continuous grinding or continuous squeal sound is present, the brake linings may be worn-out. If your vehicle has continuous vibration or shudder in the steering wheel when braking, have your vehicle checked as soon as possible.

**Note:** Brake dust may accumulate on the wheels, even under normal driving conditions. Some dust is inevitable as the brakes wear. See **Cleaning Wheels** (page 440).

**Note:** Depending on applicable laws and regulations in the country for which your vehicle was originally built, the stoplamps could flash during heavy braking. Following this the hazard warning flashers could also turn on when your vehicle comes to a stop.

Wet brakes result in reduced braking efficiency. Gently press the brake pedal a few times when driving from a car wash or standing water to dry the brakes.

### Brake Over Accelerator

In the event the accelerator pedal becomes stuck or entrapped, apply steady and firm pressure to the brake pedal to slow your vehicle and reduce engine power. If you experience this condition, apply the brakes and bring your vehicle to a safe stop. For vehicles with automatic transmission, shift into park (P). For

vehicles with manual transmission, shift into neutral. Switch the engine off and apply the parking brake. Check the accelerator pedal and the area around it for any items or debris that may be obstructing its movement. If none are found and the condition persists, have your vehicle immediately checked.

### Brake Assist

Brake assist detects when you brake hard by measuring the rate at which you press the brake pedal. It provides maximum braking efficiency as long as you press the pedal. Brake assist can reduce stopping distances in critical situations.

### Brake System Warning Lamp



**WARNING:** If you drive extended distances with the parking brake applied, you could cause damage to the brake system.

**BRAKE**

It illuminates when you engage the parking brake and the ignition is on.



If it illuminates when your vehicle is moving, make sure the parking brake is disengaged. If the parking brake is disengaged, this indicates low brake fluid level or a brake system fault. Have your vehicle checked as soon as possible.

## Brake System Information Messages

Message	Action
Check brake system	The system has detected a fault that requires service. Have your vehicle checked as soon as possible.



# Brakes

## HINTS ON DRIVING WITH ANTI-LOCK BRAKES

The anti-lock brake system helps you maintain steering control and vehicle stability during emergency stops by keeping the brakes from locking.

The anti-lock brake system does not eliminate the risks when:

- You drive too closely to the vehicle in front of you.
- Your vehicle is hydroplaning.
- You take corners too fast.
- The road surface is poor.

**Note:** *If the system activates, the brake pedal may pulse and may travel further. Maintain pressure on the brake pedal. You may also hear a noise from the system. This is normal.*

## Anti-Lock Brake System Warning Lamp



If it illuminates when you are driving, this indicates a malfunction. Your vehicle continues to have normal braking without the anti-lock brake system function. Have your vehicle checked as soon as possible.

## ELECTRIC PARKING BRAKE - MANUAL TRANSMISSION



**WARNING:** Always fully apply the parking brake. Failure to follow this instruction could result in personal injury or death.



**WARNING:** If you drive extended distances with the parking brake applied, you could cause damage to the brake system.



**WARNING:** The electric parking brake does not operate if the vehicle battery has run out of charge.

Your vehicle has an electric parking brake. You operate it with a switch instead of a lever. The switch is on the center console.

**Note:** *The electric parking brake makes noises during operation. This is normal.*

## Applying the Electric Parking Brake



Pull the switch upward.



The red warning lamp flashes during operation and illuminates when the parking brake is applied.

**Note:** *It remains illuminated for a short period of time after you switch the ignition off.*

If it continues to flash or does not illuminate, the system has malfunctioned. Have your vehicle checked as soon as possible.

**Note:** *You can apply the electric parking brake when the ignition is off.*

**Note:** *If you park your vehicle on a hill and facing uphill, select first gear and turn the steering wheel away from the curb.*

**Note:** *If you park your vehicle on a hill and facing downhill, select reverse gear and turn the steering wheel toward the curb.*

## Applying the Electric Parking Brake in an Emergency

**Note:** *Do not apply the electric parking brake when your vehicle is moving, except in an emergency. If you repeatedly use the electric parking brake to slow or stop your vehicle, you could cause damage to the brake system.*

# Brakes

You can use the electric parking brake to slow or stop your vehicle in an emergency.



Pull the switch upward and hold it.



The red warning lamp illuminates, a tone sounds and the stoplamps turn on.

The electric parking brake continues to slow your vehicle down unless you release the switch.

## Manually Releasing the Electric Parking Brake

Switch the ignition on.

Press and hold the brake pedal.



Push the switch downward.



The red warning lamp turns off.

If it remains illuminated or flashes, the system has malfunctioned. Have your vehicle checked as soon as possible.

## Pulling Away on a Hill When Towing a Trailer

Press and hold the brake pedal.



Pull the switch upward and hold it.

Shift into gear.

Press the accelerator pedal until engine has developed sufficient torque to prevent your vehicle from rolling down the hill.



Release the switch and pull away in a normal manner.

## Automatically Releasing the Electric Parking Brake

Close the driver door.

Shift into gear.

Press the accelerator pedal and pull away in a normal manner.



The red warning lamp turns off.

If it remains illuminated or flashes, the electric parking brake has not released. Manually release the parking brake.

**Note:** *The electric parking brake also automatically releases if you shift into a gear and release the clutch pedal without pressing the accelerator pedal.*

## Releasing the Electric Parking Brake if the Vehicle Battery is Running Out of Charge

Connect a booster battery to the vehicle battery to release the electric parking brake if the vehicle battery is running out of charge. See **Jump Starting the Vehicle** (page 390).

# Brakes

## Electric Parking Brake Information Messages

Message	Action
Park brake malfunction Service now	The electric parking brake has malfunctioned. Have your vehicle checked as soon as possible.
Park Brake not released	The electric parking brake has not released. Manually release the electric parking brake. If the message continues to appear, have your vehicle checked as soon as possible.
Park brake not applied	The electric parking brake has not applied. Apply the electric parking brake. If the message continues to appear, have your vehicle checked as soon as possible.
Park brake Use switch to release	The electric parking brake has not automatically released. Manually release the electric parking brake.
Park brake press brake and switch to release	You have not pressed the brake pedal. Press the brake pedal to release the parking brake.
Park brake Limited function Service required	The electric parking brake has malfunctioned. Have your vehicle checked as soon as possible.
Park brake System overheated	The electric parking brake has overheated. Wait for the electric parking brake to cool down.
Park brake off	The electric parking brake is released.
Release park brake	The electric parking brake has not released. Manually release the electric parking brake. If the message continues to appear, have your vehicle checked as soon as possible.
Park brake on	The electric parking brake is applied.

### ELECTRIC PARKING BRAKE - AUTOMATIC TRANSMISSION



**WARNING:** Apply the parking brake, shift into park (P), switch the ignition off and remove the key before you leave your vehicle. Failure to follow this instruction could result in personal injury or death.



**WARNING:** If you drive extended distances with the parking brake applied, you could cause damage to the brake system.



**WARNING:** The electric parking brake does not operate if the vehicle battery is running out of charge.

# Brakes

Your vehicle has an electric parking brake. You operate it with a switch instead of a lever. The switch is on the center console or to the left-hand side of the steering wheel, on the lower part of the instrument panel.

**Note:** *The electric parking brake makes noises during operation. This is normal.*

## Applying the Electric Parking Brake



Pull the switch upward.



The red warning lamp flashes during operation and illuminates when the parking brake is applied.

**Note:** *It remains illuminated for a short period of time after you switch the ignition off.*

If it continues to flash or does not illuminate, the system has malfunctioned. Have your vehicle checked as soon as possible.

**Note:** *You can apply the electric parking brake when the ignition is off.*

**Note:** *The electric parking brake could automatically apply when you shift into park (P). See **Park (P)** (page 237).*

## Applying the Electric Parking Brake in an Emergency

**Note:** *Do not apply the electric parking brake when your vehicle is moving, except in an emergency. If you repeatedly use the electric parking brake to slow or stop your vehicle, you could cause damage to the brake system.*

You can use the electric parking brake to slow or stop your vehicle in an emergency.



Pull the switch upward and hold it.



The red warning lamp illuminates, a tone sounds and the stoplamps turn on.

The electric parking brake continues to slow your vehicle down unless you release the switch.

## Manually Releasing the Electric Parking Brake

Switch the ignition on.

Press and hold the brake pedal.



Push the switch downward.



The red warning lamp turns off.

If it remains illuminated or flashes, the system has malfunctioned. Have your vehicle checked as soon as possible.

## Pulling Away on a Hill When Towing a Trailer

Press and hold the brake pedal.



Pull the switch upward and hold it.

Shift into gear.

Press the accelerator pedal until engine has developed sufficient torque to prevent your vehicle from rolling down the hill.



Release the switch and pull away in a normal manner.

## Automatically Releasing the Electric Parking Brake

Close the driver door.

Shift into gear.

Press the accelerator pedal and pull away in a normal manner.

# Brakes



The red warning lamp turns off.

If it remains illuminated or flashes, the electric parking brake has not released. Manually release the parking brake.

## Releasing the Electric Parking Brake if the Vehicle Battery is Running Out of Charge

Connect a booster battery to the vehicle battery to release the electric parking brake if the vehicle battery is running out of charge. See **Jump Starting the Vehicle** (page 390).

## Electric Parking Brake Information Messages

Message	Action
Park brake malfunction Service now	The electric parking brake has malfunctioned. Have your vehicle checked as soon as possible.
Park Brake not released	The electric parking brake has not released. Manually release the electric parking brake. If the message continues to appear, have your vehicle checked as soon as possible.
Park brake not applied	The electric parking brake has not applied. Apply the electric parking brake. If the message continues to appear, have your vehicle checked as soon as possible.
Park brake Use switch to release	The electric parking brake has not automatically released. Manually release the electric parking brake.
Park brake press brake and switch to release	You have not pressed the brake pedal. Press the brake pedal to release the parking brake.
Park brake Limited function Service required	The electric parking brake has malfunctioned. Have your vehicle checked as soon as possible.
Park brake System overheated	The electric parking brake has overheated. Wait for the electric parking brake to cool down.
Park brake off	The electric parking brake is released.
Release park brake	The electric parking brake has not released. Manually release the electric parking brake. If the message continues to appear, have your vehicle checked as soon as possible.
Park brake on	The electric parking brake is applied.

# Brakes

## HILL START ASSIST - VEHICLES WITH: 4.2 INCH INSTRUMENT CLUSTER DISPLAY SCREEN



**WARNING:** The system does not replace the parking brake. When you leave your vehicle, always apply the parking brake.



**WARNING:** You must remain in your vehicle when the system turns on. At all times, you are responsible for controlling your vehicle, supervising the system and intervening, if required. Failure to take care may result in the loss of control of your vehicle, serious personal injury or death.



**WARNING:** The system turns off if there is a malfunction or if you excessively rev the engine.

The system makes it easier for you to pull away when your vehicle is on a slope without using the parking brake.

When the system activates, your vehicle remains stationary for a few seconds after you release the brake pedal. This gives you time to move your foot from the brake pedal to the accelerator pedal. The brakes release when the engine has developed sufficient torque to prevent your vehicle from rolling down the slope.

### Using Hill Start Assist

1. Bring your vehicle to a complete standstill. Keep the brake pedal pressed.
2. Select a gear.

**Note:** *The system activates if the sensors detect that your vehicle is on a slope.*

3. Pull away in the normal manner.

**Note:** *When you remove your foot from the brake pedal, your vehicle remains on the slope without rolling away for a few seconds. This hold time increases if you are in the process of driving off.*

## Switching Hill Start Assist On or Off

### Vehicles with Manual Transmission

**To switch hill start assist on or off, use the information display controls on the steering wheel to select the following:**

Menu Item	Action
Driver assist.	Press the menu button.
Hill Start Assist	Press the <b>OK</b> button.

The system remembers the last setting when you start your vehicle.

**Note:** *There is no indicator to indicate whether the system is on or off.*

### Vehicles with Automatic Transmission

The system turns on when you switch the ignition on and you cannot switch the system off.

# Brakes

## Hill Start Assist Information Messages

Message	Action
Hill start assist not available	Displays when the system is not available. Have your vehicle checked as soon as possible.

### HILL START ASSIST - VEHICLES WITH: 12.3 INCH INSTRUMENT CLUSTER DISPLAY SCREEN



**WARNING:** The system does not replace the parking brake. When you leave your vehicle, always apply the parking brake.



**WARNING:** You must remain in your vehicle when the system turns on. At all times, you are responsible for controlling your vehicle, supervising the system and intervening, if required. Failure to take care may result in the loss of control of your vehicle, serious personal injury or death.



**WARNING:** The system turns off if there is a malfunction or if you excessively rev the engine.

The system makes it easier for you to pull away when your vehicle is on a slope without using the parking brake.

When the system activates, your vehicle remains stationary for a few seconds after you release the brake pedal. This gives you time to move your foot from the brake pedal to the accelerator pedal. The brakes release when the engine has developed sufficient torque to prevent your vehicle from rolling down the slope.

### Using Hill Start Assist

1. Bring your vehicle to a complete standstill. Keep the brake pedal pressed.
2. Select a gear.

**Note:** *The system activates if the sensors detect that your vehicle is on a slope.*

3. Pull away in the normal manner.

**Note:** *When you remove your foot from the brake pedal, your vehicle remains on the slope without rolling away for a few seconds. This hold time increases if you are in the process of driving off.*

### Switching Hill Start Assist On or Off

#### Vehicles with Manual Transmission

1. Press the menu button on the steering wheel to enter the information display main menu.
2. Select **Settings**.
3. Select **Driver assistance**.
4. Select **Hill start assist**.

The system remembers the last setting when you start your vehicle.

**Note:** *There is no indicator to indicate whether the system is on or off.*

#### Vehicles with Automatic Transmission

The system turns on when you switch the ignition on and you cannot switch the system off.

# Brakes

## Hill Start Assist Information Messages

Message	Action
Hill start assist not available	Displays when the system is not available. Have your vehicle checked as soon as possible.

## AUTO HOLD



**WARNING:** The system does not replace the parking brake. When you leave your vehicle, always apply the parking brake.



**WARNING:** You must remain in your vehicle when the system turns on. At all times, you are responsible for controlling your vehicle, supervising the system and intervening, if required. Failure to take care may result in the loss of control of your vehicle, serious personal injury or death.



**WARNING:** The system turns off if there is a malfunction or if you excessively rev the engine.

The system is designed to apply the brakes to hold your vehicle at a standstill after you stop your vehicle and release the brake pedal. This could be beneficial in certain situations, for example when waiting on a hill or in traffic.

## Switching Auto Hold On and Off



Press the button on the center console. The button illuminates when you switch the system on.

**Note:** You can only switch the system on after you close the driver door, fasten your seatbelt and start the engine.

**Note:** The system remembers the last setting when you start your vehicle.

Make sure you switch the system off before towing with your vehicle or before using an automatic car wash.

## Using Auto Hold

1. Use the brakes to bring your vehicle to a complete stop. The auto hold active indicator illuminates in the information display.
2. Release the brake pedal. The system holds your vehicle at a standstill. The auto hold active indicator remains illuminated in the information display.

**Note:** The system only activates if you apply enough brake pressure. If your vehicle is on a steep slope, you could need to press the brake pedal harder before the system activates.

**Note:** Under certain conditions, the system could apply the electric parking brake. The brake system warning lamp illuminates. The electric parking brake releases when you press the accelerator pedal. See **Electric Parking Brake** (page 247).

**Note:** If auto-start-stop turns off the engine, auto hold remains active.

**Note:** The system deactivates if you shift into reverse (R) and press the brake pedal.

3. Pull away in the normal manner. The system releases the brakes and the auto hold active indicator turns off.

## Auto Hold Indicator

The auto hold indicator illuminates in the information display when the system is on and is either active or unavailable.



# Brakes



Illuminates when the system is active. Your vehicle remains stationary after you release the brake pedal.



Illuminates when the system is on but unavailable to hold your vehicle at a standstill.

The system could be unavailable when any of the following occur:

- During an active park assist maneuver.
- Your vehicle is in stay in neutral mode.
- The driver door is open.
- The driver seatbelt has not been fastened.
- You shift into reverse (R) before the system is active.

## Auto Hold Information Messages

Message	Action
Auto hold Close door and fasten seat belt to enable	Displays as a reminder to fully close the driver door and fasten the driver seatbelt.
Auto hold not available	Displays when the system is not available.
Auto hold Press brake and switch to release	Displays when the system is active. Press the brake pedal and the auto hold button on the center console to switch the system off.
Auto hold System fault Press brake	Fully press the brake pedal. The system has detected a fault that requires service. Have your vehicle checked as soon as possible.
Auto hold system malfunction	The system has detected a fault that requires service. Have your vehicle checked as soon as possible.

# Traction Control

## PRINCIPLE OF OPERATION

The traction control system helps avoid drive wheel spin and loss of traction.

If your vehicle begins to slide, the system applies the brakes to individual wheels and, when needed, reduces engine power at the same time. If the wheels spin when accelerating on slippery or loose surfaces, the system reduces engine power in order to increase traction.

## USING TRACTION CONTROL



**WARNING:** The stability and traction control light illuminates steadily if the system detects a failure. Make sure you did not manually disable the traction control system using the information display controls or the switch. If the stability control and traction control light is still illuminating steadily, have the system serviced by an authorized dealer immediately. Operating your vehicle with the traction control disabled could lead to an increased risk of loss of vehicle control, vehicle rollover, personal injury and death.

If your vehicle is stuck in mud or snow, switching traction control off may be beneficial as this allows the wheels to spin.

## Switching Traction Control On or Off



Press the button on the center console.

**Note:** The system turns on when you switch the ignition on.

**Note:** If you switch traction control off, stability control remains on.

**Note:** The system turns off if there is a malfunction.

## Traction Control Off Warning Lamp



Illuminates when you switch the system off.

## Traction Control Indicator



Flashes during operation.

If it does not illuminate when you switch the ignition on, or remains on when the engine is running, this indicates a malfunction. Have your vehicle checked as soon as possible.

# Stability Control

## PRINCIPLE OF OPERATION



**WARNING:** The system is designed to aid the driver. It is not intended to replace your attention and judgment. You are still responsible to drive with due care and attention.

The system supports stability when your vehicle starts to slide away from your intended path. The system does this by braking individual wheels and reducing engine torque.

The system also provides an enhanced traction control function by reducing engine torque if the wheels spin when you accelerate. This helps to pull away on slippery roads or loose surfaces, and improves comfort by limiting wheel spin in hairpin bends.

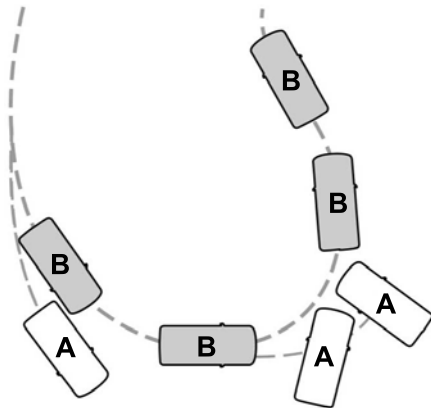

- A Without stability control.
- B With stability control.

## USING STABILITY CONTROL - EXCLUDING: ST

The system turns on when you switch the ignition on and you cannot switch the system off.

**Note:** *The system turns off if there is a malfunction.*

### Stability Control Indicator



Flashes during operation.

If it does not illuminate when you switch the ignition on, or remains on when the engine is running, this indicates a malfunction. Have your vehicle checked as soon as possible.

## USING STABILITY CONTROL - ST



**WARNING:** Do not switch off stability control or use Sport, Track or Drift mode when using a temporary spare wheel or after inflating a tire using the temporary mobility kit.

The system turns on each time you switch the ignition on.

### Reducing Stability Control



Press the button on the center console. A warning lamp illuminates and a message appears in the information display. Press the button again to switch the system on.

**Note:** *Stability control only reduces and is not fully switched off.*

**Note:** *If you switch stability control to reduced mode, traction control turns off.*

**Note:** *Pre-collision assist is disabled when you select this mode.*

# Stability Control

---

**Note:** *Adaptive cruise control is disabled when you select this mode.*

## Switching the System Off

 Press and hold the button on the center console for a few seconds to switch the system off. A warning lamp illuminates and a message appears in the information display. Press the button again to switch the system on.

**Note:** *If you switch stability control off, traction control also turns off*

**Note:** *Pre-collision assist is disabled when you select this mode.*

**Note:** *Adaptive cruise control is disabled when you select this mode.*

**Note:** *If you use a programmed MyKey, you cannot switch the system off.*

## Stability Control and Traction Control Indicator

 Flashes during operation. If it does not illuminate when you switch the ignition on, or remains on when the engine is running, this indicates a malfunction. Have your vehicle checked as soon as possible.

**Note:** *The system automatically turns off if there is a malfunction.*

## Stability Control and Traction Control Off Warning Lamp

 Illuminates when you switch the system off or to reduced mode. It also illuminates if you select track mode.

# Parking Aids

## PARKING AID PRECAUTIONS



**WARNING:** To help avoid personal injury, always use caution when in reverse (R) and when using the sensing system.



**WARNING:** The system may not detect objects with surfaces that absorb reflection. Always drive with due care and attention. Failure to take care may result in a crash.



**WARNING:** Traffic control systems, fluorescent lamps, inclement weather, air brakes, external motors and fans may affect the correct operation of the sensing system. This may cause reduced performance or false alerts.



**WARNING:** The system may not detect small or moving objects, particularly those close to the ground.



**WARNING:** The parking aid system can only assist you to detect objects when your vehicle is moving at parking speeds. To help avoid personal injury you must take care when using the parking aid system.



**WARNING:** The system may not function if the sensor is blocked.



**WARNING:** In cold and severe weather conditions the system may not function. Rain, snow and spray can all limit sensor performance.



**WARNING:** If damage occurs in the immediate area surrounding the sensor, have your vehicle checked as soon as possible.

**Note:** *If your vehicle sustains damage leaving the sensors misaligned, this will cause inaccurate measurements or false alerts.*

When you connect a trailer to your vehicle, the rear parking aid detects the trailer and provides an alert. Disable the parking aid when you connect a trailer to prevent the alert.

**Note:** *Certain add-on devices installed around the bumper or fascia may create false alerts, for example, large trailer hitches, bike or surfboard racks, license plate brackets, bumper covers or any other device that could block the normal detection zone of the parking aid system. Aftermarket spare tires or spare tire covers mounted to the rear tailgate could cause false alerts from the park aid system. Remove the add-on device to prevent false alerts.*

**Note:** *Keep the sensors free from snow, ice and large accumulations of dirt. If the sensors are covered, the system's accuracy can be affected.*

Do not clean the sensors with sharp objects.

**Note:** *When using a programmed MyKey you cannot switch this off. See **MyKey™** (page 68).*

## SWITCHING PARKING AID ON AND OFF



You can turn the system on or off by pressing the parking aid button. If your vehicle does not have a parking aid button, the system can be switched off through the information display menu or from the pop-up message that appears once you shift the transmission into reverse (R).

# Parking Aids

## REAR PARKING AID

### What is the Rear Parking Aid

Rear parking sensors detect objects behind your vehicle when in reverse (R).

### Rear Parking Aid Limitations

There is a decreased coverage area at the outer corners.

When using a programmed MyKey, you cannot switch the rear parking aid off.

The rear parking aid sensors are active when your vehicle is in reverse (R) and the vehicle speed is less than 8 km/h (5 mph).

The sensor coverage area is up to 180 cm (71 in) from the rear bumper.

The rear parking aid detects large objects when you shift into reverse (R) and any of the following occur:

- Your vehicle is moving backward at a low speed.
- Your vehicle is stationary but an object is approaching the rear of your vehicle at a low speed.
- Your vehicle is moving backward at a low speed and an object is moving towards your vehicle, for example another vehicle at a low speed.

### Locating the Rear Parking Aid Sensors



The rear parking aid sensors are in the rear bumper.

### Rear Parking Aid Audible Warnings

A warning tone sounds when your vehicle approaches an object. As your vehicle moves closer to an object, the rate of the tone increases. The warning tone continuously sounds when an object is 30 cm (12 in) or less from the rear bumper.

If your vehicle remains stationary for a few seconds, the audible warning turns off. If your vehicle moves backward the tone sounds again.

**Note:** When the parking aid system sounds a tone, the audio system could reduce the set volume.

## FRONT PARKING AID

### What is the Front Parking Aid

Front parking sensors detect objects in front of your vehicle.

# Parking Aids

## Front Parking Aid Limitations

The front parking aid sensors are active when your vehicle is in any position other than park (P) and the vehicle speed is less than 8 km/h (5 mph).

The sensor coverage area is up to 70 cm (28 in) from the bumper.

If your vehicle is in reverse (R), the front parking aid detects objects when your vehicle is moving at a low speed or an object is moving toward your vehicle and provides an audio warning, for example another vehicle at a low speed. Once your vehicle reaches a stop, the audio warning stops after a few seconds. Visual indication is always active in reverse (R).

If your vehicle is in any forward gear, the front parking aid provides audible warnings and visual indication when your vehicle is moving at a speed of 8 km/h (5 mph) or below and the system detects an object within the detection zone. Once your vehicle reaches a stop, the visual indication and audio warning stops after a few seconds.

If your vehicle is in neutral (N), the front and rear sensors provide visual indication only when your vehicle is moving below a speed of 8 km/h (5 mph) and obstacles are detected inside the detection areas. Once your vehicle stops, the visual indication and audio warning stops after a few seconds.

## Locating the Front Parking Aid Sensors



The front parking aid sensors are in the front bumper.

## Front Parking Aid Audible Warnings

A warning tone sounds when there is an object within 70 cm (28 in) from the front bumper. As your vehicle moves closer to an object, the rate of the tone increases.

The warning tone continuously sounds when an object is 30 cm (12 in) or less from the front bumper.

**Note:** *If the detected object is 30 cm (12 in) or less from your vehicle, visual indication remains on.*

## SIDE PARKING AID

### What is the Side Parking Aid

The front and rear outermost parking aid sensors map objects that are near to the sides of your vehicle.

### Side Parking Aid Limitations

The sensor coverage is up to 60 cm (24 in) from the sides of your vehicle.

# Parking Aids

The side parking aid may not function if:

- You switch your vehicle on, off and back on within a few seconds.
- Your vehicle remains stationary for over two minutes.
- The anti-lock brake system activates.
- The traction control system activates.
- Your vehicle is in park (P).
- The steering wheel angle information is not available. You must drive at least 150 m (492 ft) above 30 km/h (19 mph) to reset the steering wheel angle information.

**Note:** *If you switch traction control off, the side sensing system also turns off.*

To reinitialize the system, drive the length of your vehicle.

The side parking aid does not detect an object that is moving toward the side of your vehicle, for example another vehicle moving at a low speed, if it does not pass a front or rear parking aid sensor.

If the transmission is in reverse (R), the side sensing system provides audible warnings. When your vehicle is moving slowly, obstacles are detected within 60 cm (24 in) and are inside the driving path of your vehicle. Once your vehicle reaches a standstill condition, the audible warning stops after a few seconds. Visual indication is always present in reverse (R).

If your vehicle is in neutral (N), the side sensing system provides visual indication only when your vehicle is moving slowly and there is a front or rear park aid obstacle detected, and the side obstacle is within 60 cm (24 in) from the side of your vehicle. Once your vehicle reaches a stop, the visual indication stops after a few seconds.

If the transmission is in drive (D) or any other forward gear, the side sensing system provides audible and visual warnings. When your vehicle is moving slowly, obstacles are detected within 60 cm (24 in) and are inside the driving path of your vehicle. Once your vehicle reaches a standstill condition, the audible warning and visual indication stops after a few seconds.

## Locating the Side Parking Aid Sensors



The side parking sensors are in the front and rear bumpers.

## Side Parking Aid Audible Warnings

When the side parking aid detects an object within the coverage area and the driving path of your vehicle, an audible warning sounds. As your vehicle moves closer to the object, the rate of the tone increases.



# Parking Aids

## PARKING AID INDICATORS



The system provides object distance indication through the information display.

- As the distance to the object decreases, the indicator blocks illuminate and move toward the vehicle icon.
- If there is no object detected, the distance indicator blocks are grey.

Visual indication remains on when the transmission is in reverse (R). When you stop your vehicle, visual indication turns off after four seconds.

If the parking aids are not available, the side distance indicator blocks do not display.

## PARKING AIDS – TROUBLESHOOTING

### Parking Aids – Information Messages

If a fault is present in the parking aids, a warning message appears in the instrument cluster or the information display.

Message	Action
Park Pilot malfunction	The system has malfunctioned. Have your vehicle checked as soon as possible.
Check Park Pilot	The system has malfunctioned. Have your vehicle checked as soon as possible.
Front Park Pilot not available sensor blocked See Manual	A sensor is blocked or the system has malfunctioned. Clean the bumper or remove any obstruction. If the message continues to appear, have your vehicle checked as soon as possible.
Check front Park Pilot	The system detects a condition that requires service. Have your vehicle checked as soon as possible.

# Parking Aids

---

<b>Message</b>	<b>Action</b>
Check rear Park Pilot	The system detects a condition that requires service. Have your vehicle checked as soon as possible.
Front Park Pilot On Off	Displays the park aid status.
Rear Park Pilot On Off	Displays the park aid status.

# Rear View Camera

## WHAT IS THE REAR VIEW CAMERA

The rear view camera provides a video image of the area behind your vehicle when the transmission is in reverse (R). During operation, guide lines appear in the display that represents the path of your vehicle and proximity to objects behind it.

## REAR VIEW CAMERA PRECAUTIONS



**WARNING:** The rear view camera system is a reverse aid supplement device that still requires the driver to use it in conjunction with the interior and exterior mirrors for maximum coverage.



**WARNING:** Objects that are close to either corner of the bumper or under the bumper, might not be seen on the screen due to the limited coverage of the camera system.



**WARNING:** Reverse your vehicle slowly. Failure to follow this instruction could result in the loss of control of your vehicle, personal injury or death.



**WARNING:** Use caution when the rear cargo door is ajar. If the rear cargo door is ajar, the camera will be out of position and the video image could be incorrect. All guide lines disappear when the rear cargo door is ajar. Failure to follow this instruction could result in personal injury.



**WARNING:** Use caution when turning camera features on or off when the transmission is not in park (P). Make sure your vehicle is not moving.

**Note:** When towing, the camera only sees what you are towing. This might not provide adequate coverage and you might not see some objects. In some vehicles, the guide lines may disappear when you connect the trailer tow connector.

## REAR VIEW CAMERA LIMITATIONS

The system may not correctly operate in any of the following conditions:

- Nighttime or dark areas if the reverse lamps are not operating.
- If the camera is obstructed. Clean the lens with a soft, lint-free cloth and non-abrasive cleaner.
- The camera is misaligned due to damage to the rear of your vehicle.

## LOCATING THE REAR VIEW CAMERA



The rear view camera is on the liftgate.

## REAR VIEW CAMERA GUIDE LINES

**Note:** Active guide lines are only available when the transmission is in reverse (R).

# Rear View Camera

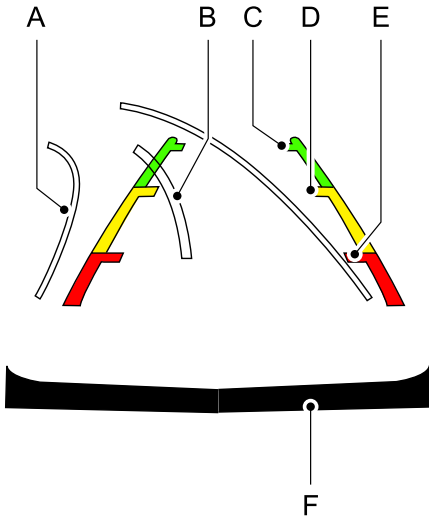

- A Active guide lines.
- B Centerline.
- C Fixed guide line: Green zone.
- D Fixed guide line: Yellow zone.
- E Fixed guide line: Red zone.
- F Rear bumper.

Active guide lines only show with fixed guide lines. To use active guide lines, turn the steering wheel to point the guide lines toward an intended path. If the steering wheel position changes while reversing, your vehicle might deviate from the intended path.

The fixed and active guide lines fade in and out depending on the steering wheel position. The active guide lines do not display when the steering wheel position is straight.

Use caution while reversing. Objects in the red zone are closest to your vehicle and objects in the green zone are farther away. Objects get closer to your vehicle as they move from the green zone to the yellow or red zones. Use the side view mirrors and rear view mirror to get better coverage on both sides and rear of your vehicle.

If the vehicle battery is disconnected, the guidelines are not fully functional directly after the battery is reconnected. The guidelines become fully functional after you drive your vehicle forward as straight as possible for five minutes at a minimum speed of 50 km/h (31 mph).

## REAR VIEW CAMERA SETTINGS

### Zooming the Rear View Camera In and Out



**WARNING:** When manual zoom is on, the full area behind your vehicle may not show. Be aware of your surroundings when using the manual zoom feature.

Selectable settings for this feature are zoom in (+) and zoom out (-). Press the symbol on the camera screen to change the view. The default setting is zoom off.

This allows you to get a closer view of an object behind your vehicle. The zoomed image keeps the bumper in the image to provide a reference. The zoom is only active while the transmission is in reverse (R).

# Rear View Camera

**Note:** *Manual zoom is only available when the transmission is in reverse (R).*

**Note:** *Only the centerline shows when you enable manual zoom.*

## Switching Rear View Camera Object Distance Indicator On and Off



If you switch this feature on, the image continues to display when you shift from reverse (R) until:

- You shift to a forward gear and the vehicle speed sufficiently increases.
- You shift in to park (P).

You can switch this feature on or off in the settings. See **Information Displays** (page 145).

When the system detects an object, it displays red, yellow and green distance indicators on the information display.

## Switching Rear View Camera Delay On and Off

You can switch this feature on or off using the touchscreen. The default setting is off. See **Settings** (page 538).

# 180 Degree Camera

## WHAT IS THE 180 DEGREE CAMERA

The 180 degree camera provides an extended image of the area behind your vehicle.

## HOW DOES THE 180 DEGREE CAMERA WORK

When you switch the 180 degree view on, the view splits into three images. You can use the right and left outer images when reversing to check for cross traffic and pedestrians.

When you use the 180 degree camera view, objects behind your vehicle are shown extremely stretched and do not appear as actual ratio.

## 180 DEGREE CAMERA PRECAUTIONS



**WARNING:** The rear view camera system is a reverse aid supplement device that still requires the driver to use it in conjunction with the interior and exterior mirrors for maximum coverage.



**WARNING:** Objects that are close to either corner of the bumper or under the bumper, might not be seen on the screen due to the limited coverage of the camera system.



**WARNING:** Reverse your vehicle slowly. Failure to follow this instruction could result in the loss of control of your vehicle, personal injury or death.



**WARNING:** Use caution when the rear cargo door is ajar. If the rear cargo door is ajar, the camera will be out of position and the video image could be incorrect. All guide lines disappear when the rear cargo door is ajar. Failure to follow this instruction could result in personal injury.



**WARNING:** Use caution when turning camera features on or off when the transmission is not in park (P). Make sure your vehicle is not moving.

**Note:** *If the image comes on while the transmission is not in reverse (R), have the system inspected by your authorized dealer.*

**Note:** *When towing, the camera only sees what you are towing. This might not provide adequate coverage and you might not see some objects.*

**Note:** *Guide lines do not appear when you switch the 180 degree view on.*

## SWITCHING THE 180 DEGREE CAMERA ON AND OFF

When you shift to reverse (R) and the rear view camera image appears, press the button in the upper left corner of the touch screen to switch the 180 degree view on. Press the button again to switch it off.

The 180 degree view turns off when you shift into park (P) or into any forward gear and the vehicle speed sufficiently increases.

**Note:** *Whenever you shift to reverse (R) the standard rear view camera image with guidelines is the default view.*

# Active Park Assist

## WHAT IS ACTIVE PARK ASSIST

Assists you with parking in and out of parking spaces.

## ACTIVE PARK ASSIST PRECAUTIONS



**WARNING:** You must remain in your vehicle when the system turns on. At all times, you are responsible for controlling your vehicle, supervising the system and intervening, if required. Failure to take care may result in the loss of control of your vehicle, serious personal injury or death.



**WARNING:** The sensors may not detect objects in heavy rain or other conditions that cause interference.



**WARNING:** You are responsible for controlling your vehicle at all times. The system is designed to be an aid and does not relieve you of your responsibility to drive with due care and attention. Failure to follow this instruction could result in the loss of control of your vehicle, personal injury or death.



**WARNING:** Do not use the system with accessories that extend beyond the front or rear of your vehicle, for example a trailer hitch or bike rack. The system is not able to make corrections for the additional length of the accessories.

## SWITCHING ACTIVE PARK ASSIST ON AND OFF



The active park assist button is next to the gearshift lever.

Press the button to activate active park assist. Press again to switch between parking modes.

Press the soft keys on the touchscreen to switch between the parallel park in, perpendicular park in, or parallel park out parking modes.

## Cancelling Active Park Assist

To cancel parking assistance at any time, press the active park assist button or turn the steering wheel.

**Note:** *It also cancels when your vehicle exceeds 9 km/h (6 mph).*

## Brake System Intervention

When active park assist is controlling the steering, it may under certain conditions apply the brakes to slow or stop your vehicle.

**Note:** *This could cause the parking assistance to cancel.*

## ENTERING A PARALLEL PARKING SPACE - 6-SPEED AUTOMATIC TRANSMISSION/ 6-SPEED MANUAL TRANSMISSION

1. Press the active park assist button.

**Note:** *The system searches for parallel parking spaces on the passenger side. Press the active park assist button again to make the system search for perpendicular spaces.*

2. Use the direction indicator lever to search for a parking space on the driver or passenger side of your vehicle.

3. Drive your vehicle approximately 1 m (3 ft) away from and parallel to the other parked vehicles when searching for a parking space.

# Active Park Assist

**Note:** A tone sounds and a message appears in the information display when active park assist finds a suitable parking space.

4. Bring your vehicle to a complete standstill.
5. Release the steering wheel and shift into reverse (R).
6. Drive backward and your vehicle steers itself into the parking space.

**Note:** You can slow down your vehicle at any time by pressing the brake pedal.

7. Follow the instructions on the information display.

**Note:** When parking is complete, a tone sounds and an information message appears.

## ENTERING A PARALLEL PARKING SPACE - 8-SPEED AUTOMATIC TRANSMISSION

**Note:** The system detects other vehicles and curbs to find a parking space.

1. Press the active park assist button.

**Note:** The system searches for parallel parking spaces on the passenger side. Press the active park assist button again to make the system search for perpendicular spaces.

2. Use the turn signal lever to search for a parking space on the driver or passenger side of your vehicle.
3. Drive your vehicle approximately 1 m (3 ft) away from and parallel to the other parked vehicles when searching for a parking space.

**Note:** A tone sounds and a message appears in the information display when active park assist finds a suitable parking space.

4. Press and hold the brake pedal.

5. Release the steering wheel and shift into neutral (N).
6. Press and hold the active park assist button.
7. Release the brake pedal to allow the vehicle to park.

**Note:** You can slow down your vehicle at any time by pressing the brake pedal.

**Note:** When parking is complete, a tone sounds and an information message appears.

**Note:** When parallel parking between objects, the system will park closer to the object in front of your vehicle to allow easier access to the luggage compartment.

## ENTERING A PERPENDICULAR PARKING SPACE - 6-SPEED AUTOMATIC TRANSMISSION/ 6-SPEED MANUAL TRANSMISSION

1. Press the active park assist button twice.
2. Use the direction indicator lever to search for a parking space on the driver or passenger side of your vehicle.
3. Drive your vehicle approximately 1 m (3 ft) away from and parallel to the other parked vehicles when searching for a parking space.

**Note:** A tone sounds and a message appears in the information display when active park assist finds a suitable parking space.

4. Bring your vehicle to a complete standstill.
5. Release the steering wheel and shift into reverse (R).
6. Drive backward and your vehicle steers itself into the parking space.



# Active Park Assist

**Note:** You can slow down your vehicle at any time by pressing the brake pedal.

7. Follow the instructions on the information display.

**Note:** When parking is complete, a tone sounds and an information message appears.

**Note:** Active park assist does not recognize parking space lines and centers your vehicle between objects.

**Note:** When the system detects only one object, it allows enough distance to open the door on either side.

## ENTERING A PERPENDICULAR PARKING SPACE - 8-SPEED AUTOMATIC TRANSMISSION

**Note:** Active park assist does not recognize parking space lines and centers your vehicle between objects.

**Note:** Active park assist backs your vehicle into parking spaces.

1. Press the active park assist button twice.
2. Use the turn signal lever to search for a parking space on the driver or passenger side of your vehicle.
3. Drive your vehicle approximately 1 m (3 ft) away from and perpendicular to the other parked vehicles when searching for a parking space.

**Note:** A tone sounds and a message appears in the instrument cluster when active park assist finds a parking space.

4. Press and hold the brake pedal.
5. Release the steering wheel and shift into neutral (N).
6. Press and hold the active park assist button.

7. Release the brake pedal to allow the vehicle to park.

**Note:** You can slow down your vehicle at any time by pressing the brake pedal.

**Note:** When parking is complete, a tone sounds and an information message appears.

**Note:** Active park assist aligns the front end of your vehicle with the lane side of the object next to it.

**Note:** When only one object is detected, the system allows enough distance to open the door on either side.

## EXITING A PARKING SPACE - 6-SPEED AUTOMATIC TRANSMISSION/6-SPEED MANUAL TRANSMISSION

The system assists leaving only parallel parking spaces.

1. Press the active park assist button.
2. Use the turn signal lever to choose the direction to leave.
3. Release the steering wheel and shift into reverse (R).
4. Follow the instructions on the information display.

**Note:** You can slow down your vehicle at any time by pressing the brake pedal.

**Note:** After the system drives your vehicle to a position where you can exit the parking space in a forward movement, a message appears instructing you to take full control of your vehicle.

# Active Park Assist

## EXITING A PARKING SPACE - 8-SPEED AUTOMATIC TRANSMISSION

The system assists leaving only parallel parking spaces.

1. Press the active park assist button.
2. Use the turn signal lever to choose the direction to leave.
3. Press and hold the brake pedal.
4. Release the steering wheel and shift into neutral (N).
5. Release the parking brake.
6. Press and hold the active park assist button.
7. Release the brake pedal to allow the vehicle to move.

**Note:** You can slow down your vehicle at any time by pressing the brake pedal.

**Note:** After the system drives your vehicle to a position where you can exit the parking space in a forward movement, a message appears instructing you to take full control of your vehicle.

## ACTIVE PARK ASSIST – TROUBLESHOOTING

### Active Park Assist – Information Messages

Message	Action
Active Park Fault	The system requires service. Have your vehicle checked as soon as possible.

### Active Park Assist – Frequently Asked Questions

#### Why does active park assist not operate correctly?

The system is unable to detect a vehicle, curb or object to park next to or in between. The system needs boundary objects to operate correctly.

#### Why does active park assist not search for a parking space?

You have switched traction control off.

#### Why does active park assist not search for a parking space?

The transmission is in reverse (R). Your vehicle must be moving forward to be able to detect a parking space.

#### Why does active park assist not offer a parking space?

The sensors could be blocked. For example, snow, ice or large accumulations of dirt. Blocked sensors can affect how the system functions.

#### Why does active park assist not offer a parking space?

The sensors in the front or rear bumper could be damaged.

# Active Park Assist

---

## **Why does active park assist not offer a parking space?**

There is not enough room in the parking space for your vehicle to safely park.

## **Why does active park assist not offer a parking space?**

There is not enough space for the parking maneuver on the opposite side of the parking space.

## **Why does active park assist not offer a parking space?**

The parking space is more than 1.5 m (5 ft) or less than 0.5 m (2 ft) away from your vehicle.

## **Why does active park assist not offer a parking space?**

Your vehicle's speed is greater than 35 km/h (22 mph) for parallel parking or greater than 30 km/h (19 mph) for perpendicular parking.

## **Why does active park assist not offer a parking space?**

You recently disconnected or replaced the battery. After you reconnect the battery you must drive your vehicle on a straight road for a short period of time.

## **Why does active park assist not correctly position the vehicle into a parking space?**

An irregular curb along the parking space prevents the system from correctly aligning your vehicle.

## **Why does active park assist not correctly position the vehicle into a parking space?**

Vehicles or objects bordering the space could not be correctly parked.

## **Why does active park assist not correctly position the vehicle into a parking space?**

Your vehicle stopped too far past the parking space.

## **Why does active park assist not correctly position the vehicle into a parking space?**

The tires are not correctly installed or maintained. For example, using a spare tire, not inflated correctly, improper size, or of different sizes.

## **Why does active park assist not correctly position the vehicle into a parking space?**

A repair or alteration changed the detection capabilities.

## **Why does active park assist not correctly position the vehicle into a parking space?**

A parked vehicle has a high attachment. For example, a salt sprayer, snowplow or moving truck bed.

## **Why does active park assist not correctly position the vehicle into a parking space?**

The parking space length, or position of parked objects, changes after your vehicle passes the space.

## **Why does active park assist not correctly position the vehicle into a parking space?**

The temperature around your vehicle quickly changes. For example, driving from a heated garage into a cold outside temperature, or after leaving a car wash.

# Cruise Control

## PRINCIPLE OF OPERATION

Cruise control lets you maintain a set speed without keeping your foot on the accelerator pedal. You can use cruise control when your vehicle speed is greater than 30 km/h (20 mph).

## USING CRUISE CONTROL



**WARNING:** Do not use cruise control on winding roads, in heavy traffic or when the road surface is slippery. This could result in loss of vehicle control, serious injury or death.



**WARNING:** When you are going downhill, your vehicle speed could increase above the set speed. The system does not apply the brakes.

The cruise controls are on the steering wheel.

## Switching Cruise Control On



Press the button.

## Switching Cruise Control Off



Press the button when the system is in standby mode. The system also turns off when you switch the ignition off.

**Note:** The set speed erases when you switch the system off.

## Setting the Cruise Speed

Drive to the required speed.

**SET+**

Press the toggle button upward or downward to set the current speed.

**SET-**

Take your foot off the accelerator pedal.

**Note:** The set speed appears in the information display.

## Changing the Set Speed

**SET+**

Press the toggle button upward to increase the set speed.

**SET-**

Press the toggle button downward to decrease the set speed.

You can adjust the set speed in small or large increments. Press the toggle button upward or downward once to adjust the set speed in small increments. Press and hold the toggle button upward or downward to adjust the set speed in large increments.

**Note:** If you accelerate by pressing the accelerator pedal, the set speed does not change. When you release the accelerator pedal, your vehicle returns to the speed that you previously set.

## Canceling the Set Speed

**CAN**

Press the button, or press the brake pedal to cancel the set speed.

**Note:** The set speed is stored.

**Note:** The system cancels if the vehicle speed drops below 16 km/h (10 mph) under the set speed when driving uphill.

## Resuming the Set Speed

**RES**

Press to resume the set speed.

# Cruise Control

## Cruise Control Indicator



The indicator appears when you switch the system on.

## USING ADAPTIVE CRUISE CONTROL - VEHICLES WITH: 4.2 INCH INSTRUMENT CLUSTER DISPLAY SCREEN/ ADAPTIVE CRUISE CONTROL



**WARNING:** You are responsible for controlling your vehicle at all times. The system is designed to be an aid and does not relieve you of your responsibility to drive with due care and attention. Failure to follow this instruction could result in the loss of control of your vehicle, personal injury or death.



**WARNING:** Pay close attention to changing road conditions such as entering or leaving a highway, on roads with intersections or roundabouts, roads without visible lanes of travel, roads that are winding, slippery, unpaved, or steep slopes.



**WARNING:** The system may not detect stationary or slow moving vehicles below 10 km/h (6 mph).



**WARNING:** Do not use the system when towing a trailer that has aftermarket electronic trailer brake controls. Failure to follow this instruction could result in the loss of control of your vehicle, personal injury or death.



**WARNING:** The system is not a crash warning or avoidance system.



**WARNING:** The system does not detect pedestrians or objects in the road.



**WARNING:** The system does not detect oncoming vehicles in the same lane.



**WARNING:** Do not use the system in poor visibility, for example fog, heavy rain, spray or snow.



**WARNING:** Do not use tire sizes other than those recommended because this can affect the normal operation of the system. Failure to do so may result in a loss of vehicle control, which could result in serious injury.

The system adjusts the vehicle speed to maintain the set gap between you and the vehicle in front of you in the same lane. You can select four gap settings.

The system uses a radar that projects a beam directly in front of your vehicle.



E248321

The adaptive cruise controls are on the steering wheel.

## Switching Adaptive Cruise Control On



Press to set the system in standby mode.

# Cruise Control



E260516

The indicator, current gap setting and set speed appear in the information display.

## Setting the Adaptive Cruise Speed

Drive to the required speed.

**SET+**

Press the toggle button upward to set the current speed.

Take your foot off the accelerator pedal.

The indicator, current gap setting and set speed appear in the information display.



E249552

A vehicle graphic appears in the information display if the system detects a vehicle in front of you.

**Note:** When adaptive cruise control is active, the speedometer may vary slightly from the set speed displayed in the information display.

## Following a Vehicle



**WARNING:** When following a vehicle that is braking, your vehicle does not always decelerate quickly enough to avoid a crash without driver intervention. Apply the brakes when necessary. Failure to follow this instruction could result in personal injury or death.



**WARNING:** The system only warns of vehicles detected by the radar sensor. In some cases there may be no warning or a delayed warning. Apply the brakes when necessary. Failure to follow this instruction could result in personal injury or death.

When a vehicle ahead of you enters the same lane or a slower vehicle is ahead in the same lane, the vehicle speed adjusts to maintain a preset gap distance. A vehicle graphic appears in the information display.

**Note:** When you are following a vehicle and you switch on a direction indicator, adaptive cruise control may provide a small temporary acceleration to help you pass.

Your vehicle maintains a consistent gap from the vehicle ahead until:

- The vehicle in front of you accelerates to a speed above the set speed.
- The vehicle in front of you moves out of the lane you are in.
- You set a new gap distance.

The system applies the brakes to slow your vehicle to maintain a safe gap distance from the vehicle in front. The system only applies limited braking. You can override the system by applying the brakes.

If the system determines that its maximum braking level is not sufficient, an audible warning sounds when the system continues to brake. Take immediate action.

# Cruise Control

**Note:** The brakes may emit noise when applied by the system.

## Setting the Gap Distance



You can decrease or increase the distance between your vehicle and the vehicle in front by pressing the gap control.

**Note:** It is your responsibility to select a gap appropriate to the driving conditions.



E249552

The selected gap appears in the information display as shown by the bars in the image. You can select four gap settings.

## Adaptive Cruise Control Distance Between Vehicle Settings

Set Speed km/h (mph)	Graphic Display - Bars Indicated Between Vehicles	Time Gap - Seconds	Distance Gap m (yd)	Dynamic Behavior
100 (62)	1	1	28 (31)	Sport.
100 (62)	2	1.4	39 (43)	Normal.
100 (62)	3	1.8	50 (55)	Normal.
100 (62)	4	2.2	61 (67)	Comfort.

When you switch the ignition on, the system selects the last chosen gap setting.

## Overriding the System



**WARNING:** If you override the system by pressing the accelerator pedal, it does not automatically apply the brakes to maintain a gap from any vehicle ahead.

Use the accelerator pedal to intentionally exceed the set speed limit.

When you override the system, the vehicle graphic disappears from the information display.

## Changing the Set Speed

**SET+**

Press the toggle button upward to increase the set speed.

**SET-**

Press the toggle button downward to decrease the set speed.

You can adjust the set speed in small or large increments. Press the toggle button upward or downward once to adjust the set speed in small increments. Press and hold the toggle button upward or downward to adjust the set speed in large increments.

# Cruise Control

The system may apply the brakes to slow your vehicle to the new set speed. The set speed continuously displays in the information display when the system is active.

## Canceling the Set Speed



Press the button, or tap the brake pedal.

The last set speed displays with a strikethrough and the last gap setting appears but does not erase.

**Note:** The set speed also cancels if you press the clutch pedal for an extended period.

## Resuming the Set Speed



Press the button.

The vehicle speed returns to the previously set speed and gap setting. The set speed continuously shows in the information display when the system is active.

**Note:** Only use resume if you are aware of the set speed and intend to return to it.

## Automatic Cancellation

The system does not operate if the vehicle speed is below 20 km/h (12 mph). A tone sounds and adaptive braking releases if the vehicle speed falls below 20 km/h (12 mph).

Automatic cancellation can also occur when:

- The tires lose traction.
- The engine speed is too low.
- You apply the parking brake.

**Note:** If the engine speed drops too low, the information display advises you to shift to a lower gear.

## Hilly Condition Usage

Select a lower gear when the system is active and you are driving downhill on steep grades, for example in mountainous areas. The system needs additional engine braking in these situations to reduce the load on the brake system to prevent it from overheating.

**Note:** A tone sounds and the system turns off if it applies brakes for an extended period of time. This allows the brakes to cool. The system operates after the brakes cool.

## Switching Adaptive Cruise Control Off



Press the button.

**Note:** The set speed erases when you switch the system off.

## Detection Issues



**WARNING:** On rare occasions, detection issues can occur due to the road infrastructures, for example bridges, tunnels and safety barriers. In these cases, the system may brake late or unexpectedly. At all times, you are responsible for controlling your vehicle, supervising the system and intervening, if required.



**WARNING:** If the system malfunctions, have your vehicle checked as soon as possible.

The radar has a limited field of view. It does not detect all vehicles in all situations and could detect vehicles later than you expect. The lead vehicle graphic does not display if the system does not detect a vehicle in front of you.



# Cruise Control

A

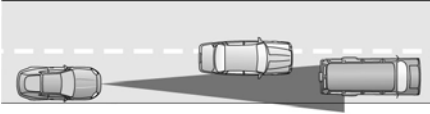

B

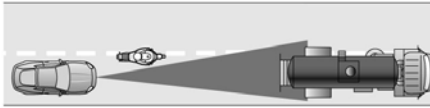

C

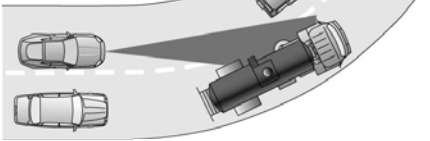

Detection issues can occur:

- A When driving on a different line than the vehicle in front.
- B With vehicles that edge into your lane. The system can only detect these vehicles once they fully move into your lane.
- C There may be issues with the detection of vehicles in front when driving into and coming out of a bend or curve in the road.

In these cases, the system may brake late or unexpectedly. You should stay alert and take action when necessary.

If something hits the front of your vehicle or damage occurs, the radar-sensing zone may change. This could cause the system to malfunction. Have your vehicle checked as soon as possible.

## System Not Available

The system may not turn on if there is:

- A blocked sensor.
- High brake temperature.
- A failure in the system or a related system.

## Adaptive Cruise Control System Sensors



**WARNING:** The system may not operate properly if the sensor is blocked. Keep the windshield free from obstruction.

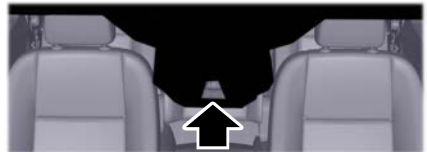

E243054

The camera is mounted behind the interior mirror.

# Cruise Control



E244279

The radar is behind the front grille below the license plate.

A message displays if something obstructs the radar signals from the sensor. The system cannot detect a vehicle ahead and does not function when something blocks the sensor.

**Note:** You cannot see the sensor, it is behind a fascia panel.

**Note:** Keep the front of your vehicle free of dirt, metal badges or objects. Vehicle front protectors, aftermarket lights, additional paint or plastic coatings could also degrade sensor performance.

Cause	Action
The surface of the radar in the radiator grille is dirty or obstructed.	Clean the radiator grille in front of the radar or remove any obstruction.
The surface of the radar is clean but the message remains in the display.	Wait a short period of time. It may take several minutes for the radar to detect that it is free from obstruction.
Heavy rain or snow interfere with the radar signals.	Do not use the system in these conditions because it may not detect any vehicles ahead.
Swirling water, snow or ice on the surface of the road interfere with the radar signals.	Do not use the system in these conditions because it may not detect any vehicles ahead.
You are in a desert or remote area with no other vehicles and no roadside objects.	Wait a short period of time or switch to normal cruise control.

Due to the nature of radar technology, a blocked sensor message could display when the sensor is not blocked. This can happen, for example, when driving in sparse rural or desert environments. A false blocked condition self clears or clears after you switch the ignition off and on.

## Switching to Normal Cruise Control



**WARNING:** Normal cruise control will not brake when your vehicle is approaching slower vehicles. Always be aware of which mode you have selected and apply the brakes when necessary.

# Cruise Control

You can change from adaptive cruise control to cruise control using the information display.

**To switch between adaptive cruise control and normal cruise control, use the information display controls on the steering wheel to select the following:**

Menu Item	Action
Driver assist.	Press the menu button.
Cruise control	Press the <b>OK</b> button.
Mode	Press the <b>OK</b> button. Press the toggle button upward or downward to choose your required setting. Press the <b>OK</b> button.



The cruise control indicator replaces the adaptive cruise control indicator if you select normal cruise control. The gap setting does not display, the system does not automatically respond to lead vehicles and adaptive braking does not activate. The system remembers the last setting when you start your vehicle.

## Adaptive Cruise Control Indicator



The indicator appears when you switch the system on.

The indicator appears in the information display when the system is in standby mode and when you set the adaptive cruise speed.

## Adaptive Cruise Control Information Messages

Message	Action
Adaptive cruise control not available Sensor blocked See manual	The radar has reduced visibility.
Adaptive cruise control not available	The system is not available.
Adaptive cruise control malfunction	The system has malfunctioned. Have your vehicle checked as soon as possible.
Cruise control active Adaptive braking off	You have switched normal cruise control on. Adaptive braking turns off.

# Cruise Control

## Adaptive Cruise Control With Speed Sign Recognition (If Equipped)



**WARNING:** You are responsible for controlling your vehicle at all times. The system is designed to be an aid and does not relieve you of your responsibility to drive with due care and attention. Failure to follow this instruction could result in the loss of control of your vehicle, personal injury or death.

The system combines speed sign recognition with adaptive cruise control. The system allows you to set the vehicle speed to the speed limit detected by the speed sign recognition system. For example, if the speed sign recognition system detects a 80 km/h (50 mph) speed limit, the vehicle speed is set to 80 km/h (50 mph).

**To switch between the cruise control modes, use the information display controls on the steering wheel to select the following:**

Menu Item	Action
Driver assist.	Press the menu button.
Cruise control	Press the <b>OK</b> button.
Mode	Press the <b>OK</b> button. Press the toggle button upward or downward to choose your required setting. Press the <b>OK</b> button.

## Intelligent Mode

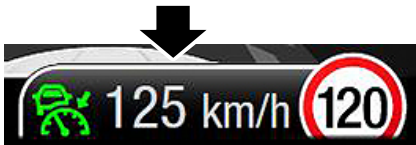

E265663

**Note:** The system does not set the vehicle speed to speed limits shown with a supplementary traffic sign in the information display.

**Note:** You can override the set speed at any time.

**Note:** The adaptive cruise control gap setting normally operates.

## Switching Between the Cruise Control Modes

You can change between the cruise control modes using the information display.

If you select this mode, a bracket appears around the set speed and the detected speed limit sign in the information display. The system is designed to set the vehicle speed to the speed limit detected by the speed sign recognition system before your vehicle passes the speed limit sign.

Under certain conditions, the system may not adjust the vehicle speed until after your vehicle passes the speed limit sign.

# Cruise Control

**Note:** The set speed adjusts when the system detects a different maximum speed limit.

If the system does not detect a speed limit, the vehicle speed remains at the current set speed.

## Automatic Cancellation

If the speed sign recognition system detects a speed limit below the minimum adaptive cruise control set speed, a tone sounds and the system returns to standby mode.

**To adjust the speed tolerance setting, use the information display controls on the steering wheel to select the following:**

Menu Item	Action
Driver assist.	Press the menu button.
Cruise control	Press the <b>OK</b> button.
Tolerance	Press the <b>OK</b> button. Press the toggle button upward or downward to choose your required speed setting. Press the <b>OK</b> button.

## Adjusting the Set Speed Tolerance Settings

You can set a permanent speed tolerance that is above or below the detected speed limit through the tolerance menu in the information display.

## Adaptive Mode

If you select this mode, adaptive cruise control operates with manual set speed input. The system does not set the vehicle speed to the speed limit detected by the speed sign recognition system.

## Normal Mode

If you select this mode, normal cruise control operates. The gap setting does not display, the system does not automatically respond to lead vehicles and adaptive braking does not activate.

## Adaptive Cruise Control With Speed Sign Recognition Information Messages

Message	Action
Adaptive cruise control Speed sign recognition not available	Navigation system based speed limit information is not available. If the message continues to appear, have your vehicle checked as soon as possible.

# Cruise Control

## USING ADAPTIVE CRUISE CONTROL - VEHICLES WITH: 4.2 INCH INSTRUMENT CLUSTER DISPLAY SCREEN/ ADAPTIVE CRUISE CONTROL WITH LANE CENTERING

**WARNING:** You are responsible for controlling your vehicle at all times. The system is designed to be an aid and does not relieve you of your responsibility to drive with due care and attention. Failure to follow this instruction could result in the loss of control of your vehicle, personal injury or death.

**WARNING:** Pay close attention to changing road conditions such as entering or leaving a highway, on roads with intersections or roundabouts, roads without visible lanes of travel, roads that are winding, slippery, unpaved, or steep slopes.

**WARNING:** The system may not detect stationary or slow moving vehicles below 10 km/h (6 mph).

**WARNING:** Do not use the system when towing a trailer that has aftermarket electronic trailer brake controls. Failure to follow this instruction could result in the loss of control of your vehicle, personal injury or death.

**WARNING:** The system is not a crash warning or avoidance system.

**WARNING:** The system does not detect pedestrians or objects in the road.

**WARNING:** The system does not detect oncoming vehicles in the same lane.

**WARNING:** Do not use the system in poor visibility, for example fog, heavy rain, spray or snow.

**WARNING:** Do not use tire sizes other than those recommended because this can affect the normal operation of the system. Failure to do so may result in a loss of vehicle control, which could result in serious injury.

The system adjusts the vehicle speed to maintain the set gap between you and the vehicle in front of you in the same lane. You can select four gap settings.

The system uses a radar that projects a beam directly in front of your vehicle.



E248321

The adaptive cruise controls are on the steering wheel.

### Switching Adaptive Cruise Control On



Press to set the system in standby mode.

# Cruise Control



E260516

The indicator, current gap setting and set speed appear in the information display.

## Setting the Adaptive Cruise Speed

Drive to the required speed.

**SET+** Press the toggle button upward to set the current speed.

Take your foot off the accelerator pedal.

The indicator, current gap setting and set speed appear in the information display.



E249552

A vehicle graphic appears in the information display if the system detects a vehicle in front of you.

**Note:** When adaptive cruise control is active, the speedometer may vary slightly from the set speed displayed in the information display.

## Setting the Adaptive Cruise Speed When Your Vehicle is Stationary

1. Follow a vehicle to a complete stop.
2. Keep the brake pedal fully pressed.
3. Press and release **SET+** or **SET-**.

The set speed adjusts to 30 km/h (20 mph).

The indicator, current gap setting and set speed appear in the information display.

## Following a Vehicle

**WARNING:** When following a vehicle that is braking, your vehicle does not always decelerate quickly enough to avoid a crash without driver intervention. Apply the brakes when necessary. Failure to follow this instruction could result in personal injury or death.

**WARNING:** The system only warns of vehicles detected by the radar sensor. In some cases there may be no warning or a delayed warning. Apply the brakes when necessary. Failure to follow this instruction could result in personal injury or death.

When a vehicle ahead of you enters the same lane or a slower vehicle is ahead in the same lane, the vehicle speed adjusts to maintain a preset gap distance. A vehicle graphic appears in the information display.

**Note:** When you are following a vehicle and you switch on a direction indicator, adaptive cruise control may provide a small temporary acceleration to help you pass.

Your vehicle maintains a consistent gap from the vehicle ahead until:

- The vehicle in front of you accelerates to a speed above the set speed.
- The vehicle in front of you moves out of the lane you are in.
- You set a new gap distance.

# Cruise Control

The system applies the brakes to slow your vehicle to maintain a safe gap distance from the vehicle in front. The system only applies limited braking. You can override the system by applying the brakes.

If the system determines that its maximum braking level is not sufficient, an audible warning sounds when the system continues to brake. Take immediate action.

## Following a Vehicle to a Complete Stop

If your vehicle follows a vehicle to a complete stop and remains stationary for less than three seconds, your vehicle accelerates from a stationary position to follow the vehicle ahead.

If your vehicle follows a vehicle to a complete stop and remains stationary for more than three seconds, press **RES** or the accelerator pedal to follow the vehicle ahead.

**Note:** *The brakes may emit noise when applied by the system.*

## Setting the Gap Distance



You can decrease or increase the distance between your vehicle and the vehicle in front by pressing the gap control.

**Note:** *It is your responsibility to select a gap appropriate to the driving conditions.*



E249552

The selected gap appears in the information display as shown by the bars in the image. You can select four gap settings.

## Adaptive Cruise Control Distance Between Vehicle Settings

Set Speed km/h (mph)	Graphic Display - Bars Indicated Between Vehicles	Time Gap - Seconds	Distance Gap m (yd)	Dynamic Beha- vior
100 (62)	1	1	28 (31)	Sport.
100 (62)	2	1.4	39 (43)	Normal.
100 (62)	3	1.8	50 (55)	Normal.
100 (62)	4	2.2	61 (67)	Comfort.

When you switch the ignition on, the system selects the last chosen gap setting.



# Cruise Control

## Overriding the System



**WARNING:** If you override the system by pressing the accelerator pedal, it does not automatically apply the brakes to maintain a gap from any vehicle ahead.

Use the accelerator pedal to intentionally exceed the set speed limit.

When you override the system, the vehicle graphic disappears from the information display.

## Changing the Set Speed

SET+

Press the toggle button upward to increase the set speed.

SET-

Press the toggle button downward to decrease the set speed.

You can adjust the set speed in small or large increments. Press the toggle button upward or downward once to adjust the set speed in small increments. Press and hold the toggle button upward or downward to adjust the set speed in large increments.

The system may apply the brakes to slow your vehicle to the new set speed. The set speed continuously displays in the information display when the system is active.

## Canceling the Set Speed



Press the button once or tap the brake pedal.

The last set speed displays with a strikethrough and the last gap setting appears but does not erase.

## Resuming the Set Speed

RES

Press the button.

The vehicle speed returns to the previously set speed and gap setting. The set speed continuously shows in the information display when the system is active.

**Note:** Only use resume if you are aware of the set speed and intend to return to it.

## Automatic Cancellation

The system could cancel if any of the following occur:

- The tires lose traction.
- You apply the parking brake.

## Parking Brake Application

Automatic parking brake application and cancellation occurs if any of the following occur:

- You unfasten the seatbelt and open the door after you stop your vehicle.
- Your vehicle remains stationary for longer than three minutes.

## Hilly Condition Usage

Select a lower gear when the system is active and you are driving downhill on steep grades, for example in mountainous areas. The system needs additional engine braking in these situations to reduce the load on the brake system to prevent it from overheating.

**Note:** A tone sounds and the system turns off if it applies brakes for an extended period of time. This allows the brakes to cool. The system operates after the brakes cool.

# Cruise Control

## Switching Adaptive Cruise Control Off



Press the button once with the system in standby mode.

**Note:** The set speed erases when you switch the system off.

## Detection Issues



**WARNING:** On rare occasions, detection issues can occur due to the road infrastructures, for example bridges, tunnels and safety barriers. In these cases, the system may brake late or unexpectedly. At all times, you are responsible for controlling your vehicle, supervising the system and intervening, if required.



**WARNING:** If the system malfunctions, have your vehicle checked as soon as possible.

The radar has a limited field of view. It does not detect all vehicles in all situations and could detect vehicles later than you expect. The lead vehicle graphic does not display if the system does not detect a vehicle in front of you.

A

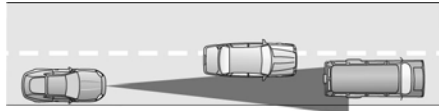

B

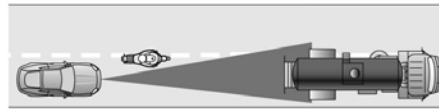

C

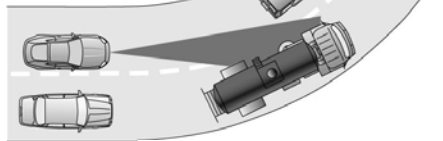

Detection issues can occur:

- A When driving on a different line than the vehicle in front.
- B With vehicles that edge into your lane. The system can only detect these vehicles once they fully move into your lane.
- C There may be issues with the detection of vehicles in front when driving into and coming out of a bend or curve in the road.

In these cases, the system may brake late or unexpectedly. You should stay alert and take action when necessary.

If something hits the front of your vehicle or damage occurs, the radar-sensing zone may change. This could cause missed or false vehicle detection

# Cruise Control

## System Not Available

- A blocked sensor.
- High brake temperature.
- A failure in the system or a related system.
- The system does not detect a lead vehicle after you stop, or driving at low speeds.

## Adaptive Cruise Control System Sensors



**WARNING:** The system may not operate properly if the sensor is blocked. Keep the windshield free from obstruction.

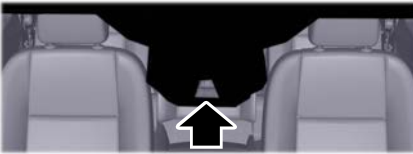

E243054

The camera is mounted behind the interior mirror.



E244279

The radar is behind the front grille below the license plate.

A message displays if something obstructs the radar signals from the sensor. The system cannot detect a vehicle ahead and does not function when something blocks the sensor.

**Note:** You cannot see the sensor, it is behind a fascia panel.

**Note:** Keep the front of your vehicle free of dirt, metal badges or objects. Vehicle front protectors, aftermarket lights, additional paint or plastic coatings could also degrade sensor performance.

# Cruise Control

Cause	Action
The surface of the radar in the radiator grille is dirty or obstructed.	Clean the radiator grille in front of the radar or remove any obstruction.
The surface of the radar is clean but the message remains in the display.	Wait a short period of time. It may take several minutes for the radar to detect that it is free from obstruction.
Heavy rain or snow interfere with the radar signals.	Do not use the system in these conditions because it may not detect any vehicles ahead.
Swirling water, snow or ice on the surface of the road interfere with the radar signals.	Do not use the system in these conditions because it may not detect any vehicles ahead.
You are in a desert or remote area with no other vehicles and no roadside objects.	Wait for a short period of time or switch to normal cruise control.

Due to the nature of radar technology, a blocked sensor message could display when the sensor is not blocked. This can happen, for example, when driving in sparse rural or desert environments. A false blocked condition self clears or clears after you switch the ignition off and on.

## Switching to Normal Cruise Control



**WARNING:** Normal cruise control will not brake when your vehicle is approaching slower vehicles. Always be aware of which mode you have selected and apply the brakes when necessary.

You can change from adaptive cruise control to cruise control using the information display.

**To switch between adaptive cruise control and normal cruise control, use the information display controls on the steering wheel to select the following:**

Menu Item	Action
Driver assist.	Press the menu button.
Cruise control	Press the <b>OK</b> button.
Mode	Press the <b>OK</b> button. Press the toggle button upward or downward to choose your required setting. Press the <b>OK</b> button.

# Cruise Control



The cruise control indicator replaces the adaptive cruise control indicator if you select normal cruise control. The gap setting does not display, the system does not automatically respond to lead vehicles and adaptive braking does not activate. The system remembers the last setting when you start your vehicle.

## Adaptive Cruise Control Indicator



The indicator appears when you switch the system on.

The indicator appears in the information display when the system is in standby mode and when you set the adaptive cruise speed.

## Adaptive Cruise Control Information Messages

Message	Action
Adaptive cruise control not available Sensor blocked See manual	The radar has reduced visibility.
Adaptive cruise control not available	The system is not available.
Adaptive cruise control malfunction	The system has malfunctioned. Have your vehicle checked as soon as possible.
Adaptive cruise control Speed too low to activate	You have switched the system on when your vehicle speed is too low.
Cruise control active Adaptive braking off	You have switched normal cruise control on. Adaptive braking turns off.

## Adaptive Cruise Control With Lane Centering



**WARNING:** You are responsible for controlling your vehicle at all times. The system is designed to be an aid and does not relieve you of your responsibility to drive with due care and attention. Failure to follow this instruction could result in the loss of control of your vehicle, personal injury or death.



**WARNING:** Pay close attention to changing road conditions such as entering or leaving a highway, on roads with intersections or roundabouts, roads without visible lanes of travel, roads that are winding, slippery, unpaved, or steep slopes.



**WARNING:** Do not use the system in poor visibility, for example fog, heavy rain, spray or snow.



**WARNING:** Large contrasts in outside lighting can limit sensor performance.

# Cruise Control



**WARNING:** The sensor may incorrectly track lane markings as other structures or objects. This can result in a false or missed warning.



**WARNING:** The system will not operate if the sensor cannot track the road lane markings.

The system is designed to help keep your vehicle in the center of the lane by applying continuous assistance steering torque input toward the lane center on highways.

**Note:** *The assistance steering torque is limited and may not be sufficient for all driving situations.*

**Note:** *In exceptional conditions, the system may deviate from the center line.*

The system only operates when the all of the following occur:

- You have adaptive cruise control with stop-and-go on.
- The system detects lane markings.
- Your hands are on the steering wheel at all times.
- The vehicle is centered in the lane.

**Note:** *The system may not function if the front camera or sensor is blocked or not available.*

## Switching Lane Centering On and Off



Press and release the button.

The indicator appears in the information display. When the system is on, the color of the indicator changes to indicate the system status.

Gray indicates the system is on but inactive.

Green indicates the system is active and applying assistance steering torque input to keep your vehicle in the center of the lane.

The system activates when it detects valid lane markings. If it does not detect valid lane markings, the system stays inactive until valid markings are available.

The system may not correctly operate in any of the following conditions:

- The lane is too narrow or wide.
- The system does not detect lane markings or when lanes merge or split.
- Limited steering torque input is applied.
- Areas under construction or new infrastructure.
- When modifications to the steering system have been made.
- When using a spare tire.

When the system is active and the direction indicator is switched on, the system immediately cancels. The system remains in standby mode as long as the direction indicator is engaged. The system re-activates automatically once the vehicle is centered in a lane and the direction indicator is switched off.

When the system is active and detects no steering activity for a certain period of time, the system alerts you to put your hands on the steering wheel. If you do not react to the warnings the system cancels and slows your vehicle down to idle speeds while maintaining steering control.

The system also alerts you if your vehicle crosses lane markings without detected steering activity.

**Note:** *The system may detect a light grip or touch on the steering wheel as hands off driving.*

You can override the system at any time by steering your vehicle.

# Cruise Control

## Automatic Cancellation

**WARNING:** Do not use the system if any changes or modifications to the steering wheel have been made. Any changes or modifications to the steering wheel could affect the functionality or performance of the system. Failure to follow this instruction could result in the loss of control of your vehicle, personal injury or death.

When the system is cancelled due to an external condition, for example, no lane markings are available and your hands are on the steering wheel, a tone sounds and a message appears in the information display.

When the system is cancelled due to an external condition, for example, no lane markings are available and your hands are not on the steering wheel, the system immediately alerts you to take control of the vehicle. If this alert is ignored, the system slows the vehicle while maintaining steering control.

**RES**

If your vehicle starts to slow down, you must contribute to the steering control and press and release the button or briefly press the accelerator pedal to regain full system performance.

Automatic cancellation can also occur if:

- The lane becomes too wide or narrow.
- The system cannot detect valid lane markings.
- Lane markings are crossed.
- The curve of the road is too sharp.

**Note:** *The system disables until the next key cycle if your vehicle slows down due to driver inactivity twice within a key cycle.*

## Blocked Sensors

**WARNING:** The system may not operate properly if the sensor is blocked. Keep the windshield free from obstruction.



E243054

The camera is mounted behind the interior mirror.



E244279

The radar is behind the front grille below the license plate.

**Note:** *You cannot see the radar, it is behind a fascia panel.*

A message displays if something obstructs the radar signals from the sensor. The system cannot detect a vehicle ahead and does not function when something blocks the sensor.

# Cruise Control

**Note:** Keep the front of your vehicle free of dirt, metal badges or objects. Vehicle front protectors, aftermarket lights, additional paint or plastic coatings could also degrade sensor performance.

## Lane Centering Information Messages

Message	Action
Lane centring assist not available	The system is not available. If it is still not available the next time you switch the ignition on, the system has malfunctioned. Have your vehicle checked as soon as possible.

## Adaptive Cruise Control With Speed Sign Recognition (If Equipped)



**WARNING:** You are responsible for controlling your vehicle at all times. The system is designed to be an aid and does not relieve you of your responsibility to drive with due care and attention. Failure to follow this instruction could result in the loss of control of your vehicle, personal injury or death.

The system combines speed sign recognition with adaptive cruise control. The system allows you to set the vehicle speed to the speed limit detected by the speed sign recognition system. For example, if the speed sign recognition system detects a 80 km/h (50 mph) speed limit, the vehicle speed is set to 80 km/h (50 mph).

**Note:** The system does not set the vehicle speed to speed limits shown with a supplementary traffic sign in the information display.

**Note:** You can override the set speed at any time.

**Note:** The adaptive cruise control gap setting normally operates.

## Switching Between the Cruise Control Modes

You can change between the cruise control modes using the information display.



# Cruise Control

**To switch between the cruise control modes, use the information display controls on the steering wheel to select the following:**

Menu Item	Action
Driver assist.	Press the menu button.
Cruise control	Press the <b>OK</b> button.
Mode	Press the <b>OK</b> button. Press the toggle button upward or downward to choose your required setting. Press the <b>OK</b> button.

## Intelligent Mode



E265663

If you select this mode, a bracket appears around the set speed and the detected speed limit sign in the information display. The system is designed to set the vehicle speed to the speed limit detected by the speed sign recognition system before your vehicle passes the speed limit sign.

Under certain conditions, the system may not adjust the vehicle speed until after your vehicle passes the speed limit sign.

**To adjust the speed tolerance setting, use the information display controls on the steering wheel to select the following:**

Menu item	Description and action
Driver assist.	Press the menu button.
Cruise control	Press the <b>OK</b> button.
Tolerance	Press the <b>OK</b> button. Press the toggle button upward or downward to choose your required speed setting. Press the <b>OK</b> button.

**Note:** *The set speed adjusts when the system detects a different maximum speed limit.*

If the system does not detect a speed limit, the vehicle speed remains at the current set speed.

### Automatic Cancellation

If the speed sign recognition system detects a speed limit below the minimum adaptive cruise control set speed, a tone sounds and the system returns to standby mode.

### Adjusting the Set Speed Tolerance Settings

You can set a permanent speed tolerance that is above or below the detected speed limit through the tolerance menu in the information display.

# Cruise Control

## Adaptive Mode

If you select this mode, adaptive cruise control operates with manual set speed input. The system does not set the vehicle speed to the speed limit detected by the speed sign recognition system.

## Normal Mode

If you select this mode, normal cruise control operates. The gap setting does not display, the system does not automatically respond to lead vehicles and adaptive braking does not activate.

## Adaptive Cruise Control With Speed Sign Recognition Information Messages

Message	Action
Adaptive cruise control Speed sign recognition not available	Navigation system based speed limit information is not available. If the message continues to appear, have your vehicle checked as soon as possible.

## USING ADAPTIVE CRUISE CONTROL - VEHICLES WITH: 12.3 INCH INSTRUMENT CLUSTER DISPLAY SCREEN/ ADAPTIVE CRUISE CONTROL

 **WARNING:** You are responsible for controlling your vehicle at all times. The system is designed to be an aid and does not relieve you of your responsibility to drive with due care and attention. Failure to follow this instruction could result in the loss of control of your vehicle, personal injury or death.

 **WARNING:** Pay close attention to changing road conditions such as entering or leaving a highway, on roads with intersections or roundabouts, roads without visible lanes of travel, roads that are winding, slippery, unpaved, or steep slopes.

 **WARNING:** The system may not detect stationary or slow moving vehicles below 10 km/h (6 mph).

 **WARNING:** Do not use the system when towing a trailer that has aftermarket electronic trailer brake controls. Failure to follow this instruction could result in the loss of control of your vehicle, personal injury or death.

 **WARNING:** The system is not a crash warning or avoidance system.

 **WARNING:** The system does not detect pedestrians or objects in the road.

 **WARNING:** The system does not detect oncoming vehicles in the same lane.

 **WARNING:** Do not use the system in poor visibility, for example fog, heavy rain, spray or snow.

 **WARNING:** Do not use tire sizes other than those recommended because this can affect the normal operation of the system. Failure to do so may result in a loss of vehicle control, which could result in serious injury.

# Cruise Control

The system adjusts the vehicle speed to maintain the set gap between you and the vehicle in front of you in the same lane. You can select four gap settings.

The system uses a radar that projects a beam directly in front of your vehicle.



E248321

The adaptive cruise controls are on the steering wheel.

## Switching Adaptive Cruise Control On



Press to set the system in standby mode.



E260516

The indicator, current gap setting and set speed appear in the information display.

## Setting the Adaptive Cruise Speed

Drive to the required speed.



Press the toggle button upward to set the current speed.

Take your foot off the accelerator pedal.

The indicator, current gap setting and set speed appear in the information display.



E249552

A vehicle graphic appears in the information display if the system detects a vehicle in front of you.

**Note:** When adaptive cruise control is active, the speedometer may vary slightly from the set speed displayed in the information display.

## Following a Vehicle



**WARNING:** When following a vehicle that is braking, your vehicle does not always decelerate quickly enough to avoid a crash without driver intervention. Apply the brakes when necessary. Failure to follow this instruction could result in personal injury or death.



**WARNING:** The system only warns of vehicles detected by the radar sensor. In some cases there may be no warning or a delayed warning. Apply the brakes when necessary. Failure to follow this instruction could result in personal injury or death.

When a vehicle ahead of you enters the same lane or a slower vehicle is ahead in the same lane, the vehicle speed adjusts to maintain a preset gap distance. A vehicle graphic appears in the information display.

# Cruise Control

**Note:** When you are following a vehicle and you switch on a direction indicator, adaptive cruise control may provide a small temporary acceleration to help you pass.

Your vehicle maintains a consistent gap from the vehicle ahead until:

- The vehicle in front of you accelerates to a speed above the set speed.
- The vehicle in front of you moves out of the lane you are in.
- You set a new gap distance.

The system applies the brakes to slow your vehicle to maintain a safe gap distance from the vehicle in front. The system only applies limited braking. You can override the system by applying the brakes.

If the system determines that its maximum braking level is not sufficient, an audible warning sounds when the system continues to brake. Take immediate action.

**Note:** The brakes may emit noise when applied by the system.

## Adaptive Cruise Control Distance Between Vehicle Settings

Set Speed km/h (mph)	Graphic Display - Bars Indicated Between Vehicles	Time Gap - Seconds	Distance Gap m (yd)	Dynamic Behavior
100 (62)	1	1	28 (31)	Sport.
100 (62)	2	1.4	39 (43)	Normal.
100 (62)	3	1.8	50 (55)	Normal.
100 (62)	4	2.2	61 (67)	Comfort.

When you switch the ignition on, the system selects the last chosen gap setting.

## Setting the Gap Distance



You can decrease or increase the distance between your vehicle and the vehicle in front by pressing the gap control.

**Note:** It is your responsibility to select a gap appropriate to the driving conditions.



E249552

The selected gap appears in the information display as shown by the bars in the image. You can select four gap settings.

# Cruise Control

## Overriding the System



**WARNING:** If you override the system by pressing the accelerator pedal, it does not automatically apply the brakes to maintain a gap from any vehicle ahead.

Use the accelerator pedal to intentionally exceed the set speed limit.

When you override the system, the vehicle graphic disappears from the information display.

## Changing the Set Speed

**SET+**

Press the toggle button upward to increase the set speed.

**SET-**

Press the toggle button downward to decrease the set speed.

You can adjust the set speed in small or large increments. Press the toggle button upward or downward once to adjust the set speed in small increments. Press and hold the toggle button upward or downward to adjust the set speed in large increments.

The system may apply the brakes to slow your vehicle to the new set speed. The set speed continuously displays in the information display when the system is active.

## Canceling the Set Speed

**CAN**

Press the button, or tap the brake pedal.

The last set speed displays with a strikethrough and the last gap setting appears but does not erase.

**Note:** The set speed also cancels if you press the clutch pedal for an extended period.

## Resuming the Set Speed

**RES**

Press the button.

The vehicle speed returns to the previously set speed and gap setting. The set speed continuously shows in the information display when the system is active.

**Note:** Only use resume if you are aware of the set speed and intend to return to it.

## Automatic Cancellation

The system does not operate if the vehicle speed is below 20 km/h (12 mph). A tone sounds and adaptive braking releases if the vehicle speed falls below 20 km/h (12 mph).

Automatic cancellation can also occur when:

- The tires lose traction.
- The engine speed is too low.
- You apply the parking brake.

**Note:** If the engine speed drops too low, the information display advises you to shift to a lower gear.

## Hilly Condition Usage

Select a lower gear when the system is active and you are driving downhill on steep grades, for example in mountainous areas. The system needs additional engine braking in these situations to reduce the load on the brake system to prevent it from overheating.

**Note:** A tone sounds and the system turns off if it applies brakes for an extended period of time. This allows the brakes to cool. The system operates after the brakes cool.

# Cruise Control

## Switching Adaptive Cruise Control Off



Press the button.

**Note:** The set speed erases when you switch the system off.

## Detection Issues



**WARNING:** On rare occasions, detection issues can occur due to the road infrastructures, for example bridges, tunnels and safety barriers. In these cases, the system may brake late or unexpectedly. At all times, you are responsible for controlling your vehicle, supervising the system and intervening, if required.



**WARNING:** If the system malfunctions, have your vehicle checked as soon as possible.

The radar has a limited field of view. It does not detect all vehicles in all situations and could detect vehicles later than you expect. The lead vehicle graphic does not display if the system does not detect a vehicle in front of you.

A

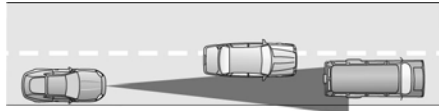

B



C

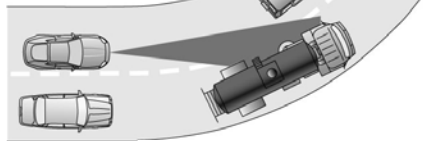

Detection issues can occur:

- A When driving on a different line than the vehicle in front.
- B With vehicles that edge into your lane. The system can only detect these vehicles once they fully move into your lane.
- C There may be issues with the detection of vehicles in front when driving into and coming out of a bend or curve in the road.

In these cases, the system may brake late or unexpectedly. You should stay alert and take action when necessary.

# Cruise Control

If something hits the front of your vehicle or damage occurs, the radar-sensing zone may change. This could cause the system to malfunction. Have your vehicle checked as soon as possible.

## System Not Available

The system may not turn on if there is:

- A blocked sensor.
- High brake temperature.
- A failure in the system or a related system.

## Adaptive Cruise Control System Sensors



**WARNING:** The system may not operate properly if the sensor is blocked. Keep the windshield free from obstruction.



E243054

The camera is mounted behind the interior mirror.



E244279

The radar is behind the front grille below the license plate.

A message displays if something obstructs the radar signals from the sensor. The system cannot detect a vehicle ahead and does not function when something blocks the sensor.

**Note:** You cannot see the sensor, it is behind a fascia panel.

**Note:** Keep the front of your vehicle free of dirt, metal badges or objects. Vehicle front protectors, aftermarket lights, additional paint or plastic coatings could also degrade sensor performance.

# Cruise Control

Cause	Action
The surface of the radar in the radiator grille is dirty or obstructed.	Clean the radiator grille in front of the radar or remove any obstruction.
The surface of the radar is clean but the message remains in the display.	Wait a short period of time. It may take several minutes for the radar to detect that it is free from obstruction.
Heavy rain or snow interfere with the radar signals.	Do not use the system in these conditions because it may not detect any vehicles ahead.
Swirling water, snow or ice on the surface of the road interfere with the radar signals.	Do not use the system in these conditions because it may not detect any vehicles ahead.
You are in a desert or remote area with no other vehicles and no roadside objects.	Wait a short period of time or switch to normal cruise control.

Due to the nature of radar technology, a blocked sensor message could display when the sensor is not blocked. This can happen, for example, when driving in sparse rural or desert environments. A false blocked condition self clears or clears after you switch the ignition off and on.

## Switching to Normal Cruise Control



**WARNING:** Normal cruise control will not brake when your vehicle is approaching slower vehicles. Always be aware of which mode you have selected and apply the brakes when necessary.

You can change from adaptive cruise control to cruise control using the information display.

**To switch between adaptive cruise control and normal cruise control, press the menu button on the steering wheel to enter the information display main menu and select the following:**

Menu Item	Action
Settings	Press the <b>OK</b> button.
Driver assistance	Press the <b>OK</b> button.
Cruise control	Press the <b>OK</b> button.



# Cruise Control

Menu Item	Action
Normal	Select a setting and press the <b>OK</b> button.
Adaptive	
Intelligent	



The cruise control indicator replaces the adaptive cruise control indicator if you select normal cruise control. The gap setting does not display, the system does not automatically respond to lead vehicles and adaptive braking does not activate. The system remembers the last setting when you start your vehicle.

## Adaptive Cruise Control Indicator



The indicator appears when you switch the system on.

The indicator appears in the information display when the system is in standby mode and when you set the adaptive cruise speed.

## Adaptive Cruise Control Information Messages

Message	Action
Adaptive cruise control not available Sensor blocked See manual	The radar has reduced visibility.
Adaptive cruise control not available	The system is not available.
Adaptive cruise control malfunction	The system has malfunctioned. Have your vehicle checked as soon as possible.
Cruise control active Adaptive braking off	You have switched normal cruise control on. Adaptive braking turns off.

# Cruise Control

## Adaptive Cruise Control With Speed Sign Recognition (If Equipped)



**WARNING:** You are responsible for controlling your vehicle at all times. The system is designed to be an aid and does not relieve you of your responsibility to drive with due care and attention. Failure to follow this instruction could result in the loss of control of your vehicle, personal injury or death.

The system combines speed sign recognition with adaptive cruise control. The system allows you to set the vehicle speed to the speed limit detected by the speed sign recognition system. For example, if the speed sign recognition system detects a 80 km/h (50 mph) speed limit, the vehicle speed is set to 80 km/h (50 mph).

**To switch between the cruise control modes, press the menu button on the steering wheel to enter the information display main menu and select the following:**

Menu Item	Action
Settings	Press the <b>OK</b> button.
Driver assistance	Press the <b>OK</b> button.
Cruise control	Press the <b>OK</b> button.
Normal	Select a setting and press the <b>OK</b> button.
Adaptive	
Intelligent	

**Note:** The system does not set the vehicle speed to speed limits shown with a supplementary traffic sign in the information display.

**Note:** You can override the set speed at any time.

**Note:** The adaptive cruise control gap setting normally operates.

## Switching Between the Cruise Control Modes

You can change between the cruise control modes using the information display.

# Cruise Control

## Intelligent Mode



E265663

If you select this mode, a bracket appears around the set speed and the detected speed limit sign in the information display. The system is designed to set the vehicle speed to the speed limit detected by the speed sign recognition system before your vehicle passes the speed limit sign.

Under certain conditions, the system may not adjust the vehicle speed until after your vehicle passes the speed limit sign.

**Note:** The set speed adjusts when the system detects a different maximum speed limit.

If the system does not detect a speed limit, the vehicle speed remains at the current set speed.

### Automatic Cancellation

If the speed sign recognition system detects a speed limit below the minimum adaptive cruise control set speed, a tone sounds and the system returns to standby mode.

### Adjusting the Set Speed Tolerance Settings

You can set a permanent speed tolerance that is above or below the detected speed limit through the tolerance menu in the information display.

**To adjust the speed tolerance setting, press the menu button on the steering wheel to enter the information display main menu and select the following:**

Menu Item	Action
Settings	Press the <b>OK</b> button.
Driver assistance	Press the <b>OK</b> button.
Cruise control	Press the <b>OK</b> button.
Intelligent	Press the <b>OK</b> button.
Tolerance	Press the <b>OK</b> button. Select a setting and press the <b>OK</b> button.

## Adaptive Mode

If you select this mode, adaptive cruise control operates with manual set speed input. The system does not set the vehicle speed to the speed limit detected by the speed sign recognition system.

## Normal Mode

If you select this mode, normal cruise control operates. The gap setting does not display, the system does not automatically respond to lead vehicles and adaptive braking does not activate.

# Cruise Control

## Adaptive Cruise Control With Speed Sign Recognition Information Messages

Message	Action
Adaptive cruise control Speed sign recognition not available	Navigation system based speed limit information is not available. If the message continues to appear, have your vehicle checked as soon as possible.

### USING ADAPTIVE CRUISE CONTROL - VEHICLES WITH: 12.3 INCH INSTRUMENT CLUSTER DISPLAY SCREEN/ ADAPTIVE CRUISE CONTROL WITH LANE CENTERING

 **WARNING:** You are responsible for controlling your vehicle at all times. The system is designed to be an aid and does not relieve you of your responsibility to drive with due care and attention. Failure to follow this instruction could result in the loss of control of your vehicle, personal injury or death.

 **WARNING:** Pay close attention to changing road conditions such as entering or leaving a highway, on roads with intersections or roundabouts, roads without visible lanes of travel, roads that are winding, slippery, unpaved, or steep slopes.

 **WARNING:** The system may not detect stationary or slow moving vehicles below 10 km/h (6 mph).

 **WARNING:** Do not use the system when towing a trailer that has aftermarket electronic trailer brake controls. Failure to follow this instruction could result in the loss of control of your vehicle, personal injury or death.

 **WARNING:** The system is not a crash warning or avoidance system.

 **WARNING:** The system does not detect pedestrians or objects in the road.

 **WARNING:** The system does not detect oncoming vehicles in the same lane.

 **WARNING:** Do not use the system in poor visibility, for example fog, heavy rain, spray or snow.

 **WARNING:** Do not use tire sizes other than those recommended because this can affect the normal operation of the system. Failure to do so may result in a loss of vehicle control, which could result in serious injury.

The system adjusts the vehicle speed to maintain the set gap between you and the vehicle in front of you in the same lane. You can select four gap settings.

The system uses a radar that projects a beam directly in front of your vehicle.

# Cruise Control



E248321

The adaptive cruise controls are on the steering wheel.

## Switching Adaptive Cruise Control On



Press to set the system in standby mode.



E260516

The indicator, current gap setting and set speed appear in the information display.

## Setting the Adaptive Cruise Speed

Drive to the required speed.



Press the toggle button upward to set the current speed.

Take your foot off the accelerator pedal.

The indicator, current gap setting and set speed appear in the information display.



E249552

A vehicle graphic appears in the information display if the system detects a vehicle in front of you.

**Note:** When adaptive cruise control is active, the speedometer may vary slightly from the set speed displayed in the information display.

## Setting the Adaptive Cruise Speed When Your Vehicle is Stationary

1. Follow a vehicle to a complete stop.
2. Keep the brake pedal fully pressed.
3. Press and release **SET+** or **SET-**.

The set speed adjusts to 30 km/h (20 mph).

The indicator, current gap setting and set speed appear in the information display.

## Following a Vehicle



**WARNING:** When following a vehicle that is braking, your vehicle does not always decelerate quickly enough to avoid a crash without driver intervention. Apply the brakes when necessary. Failure to follow this instruction could result in personal injury or death.

# Cruise Control



**WARNING:** The system only warns of vehicles detected by the radar sensor. In some cases there may be no warning or a delayed warning. Apply the brakes when necessary. Failure to follow this instruction could result in personal injury or death.

When a vehicle ahead of you enters the same lane or a slower vehicle is ahead in the same lane, the vehicle speed adjusts to maintain a preset gap distance. A vehicle graphic appears in the information display.

**Note:** When you are following a vehicle and you switch on a direction indicator, adaptive cruise control may provide a small temporary acceleration to help you pass.

Your vehicle maintains a consistent gap from the vehicle ahead until:

- The vehicle in front of you accelerates to a speed above the set speed.
- The vehicle in front of you moves out of the lane you are in.
- You set a new gap distance.

The system applies the brakes to slow your vehicle to maintain a safe gap distance from the vehicle in front. The system only applies limited braking. You can override the system by applying the brakes.

If the system determines that its maximum braking level is not sufficient, an audible warning sounds when the system continues to brake. Take immediate action.

## Following a Vehicle to a Complete Stop

If your vehicle follows a vehicle to a complete stop and remains stationary for less than three seconds, your vehicle accelerates from a stationary position to follow the vehicle ahead.

If your vehicle follows a vehicle to a complete stop and remains stationary for more than three seconds, press **RES** or the accelerator pedal to follow the vehicle ahead.

**Note:** The brakes may emit noise when applied by the system.

## Setting the Gap Distance



You can decrease or increase the distance between your vehicle and the vehicle in front by pressing the gap control.

**Note:** It is your responsibility to select a gap appropriate to the driving conditions.



E249552

The selected gap appears in the information display as shown by the bars in the image. You can select four gap settings.

# Cruise Control

## Adaptive Cruise Control Distance Between Vehicle Settings

Set Speed km/h (mph)	Graphic Display - Bars Indicated Between Vehicles	Time Gap - Seconds	Distance Gap m (yd)	Dynamic Beha- vior
100 (62)	1	1	28 (31)	Sport.
100 (62)	2	1.4	39 (43)	Normal.
100 (62)	3	1.8	50 (55)	Normal.
100 (62)	4	2.2	61 (67)	Comfort.

When you switch the ignition on, the system selects the last chosen gap setting.

### Overriding the System



**WARNING:** If you override the system by pressing the accelerator pedal, it does not automatically apply the brakes to maintain a gap from any vehicle ahead.

Use the accelerator pedal to intentionally exceed the set speed limit.

When you override the system, the vehicle graphic disappears from the information display.

### Changing the Set Speed

**SET+**

Press the toggle button upward to increase the set speed.

**SET-**

Press the toggle button downward to decrease the set speed.

You can adjust the set speed in small or large increments. Press the toggle button upward or downward once to adjust the set speed in small increments. Press and hold the toggle button upward or downward to adjust the set speed in large increments.

The system may apply the brakes to slow your vehicle to the new set speed. The set speed continuously displays in the information display when the system is active.

### Canceling the Set Speed



Press the button once or tap the brake pedal.

The last set speed displays with a strikethrough and the last gap setting appears but does not erase.

### Resuming the Set Speed

**RES**

Press the button.

The vehicle speed returns to the previously set speed and gap setting. The set speed continuously shows in the information display when the system is active.

# Cruise Control

**Note:** Only use resume if you are aware of the set speed and intend to return to it.

## Automatic Cancellation

The system could cancel if any of the following occur:

- The tires lose traction.
- You apply the parking brake.

## Parking Brake Application

Automatic parking brake application and cancellation occurs if any of the following occur:

- You unfasten the seatbelt and open the door after you stop your vehicle.
- Your vehicle remains stationary for longer than three minutes.

## Hilly Condition Usage

Select a lower gear when the system is active and you are driving downhill on steep grades, for example in mountainous areas. The system needs additional engine braking in these situations to reduce the load on the brake system to prevent it from overheating.

**Note:** A tone sounds and the system turns off if it applies brakes for an extended period of time. This allows the brakes to cool. The system operates after the brakes cool.

## Switching Adaptive Cruise Control Off



Press the button once with the system in standby mode.

**Note:** The set speed erases when you switch the system off.

## Detection Issues



**WARNING:** On rare occasions, detection issues can occur due to the road infrastructures, for example bridges, tunnels and safety barriers. In these cases, the system may brake late or unexpectedly. At all times, you are responsible for controlling your vehicle, supervising the system and intervening, if required.



**WARNING:** If the system malfunctions, have your vehicle checked as soon as possible.

The radar has a limited field of view. It does not detect all vehicles in all situations and could detect vehicles later than you expect. The lead vehicle graphic does not display if the system does not detect a vehicle in front of you.



# Cruise Control

A

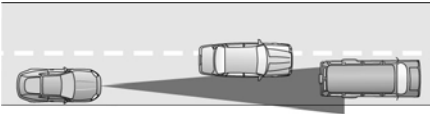

B

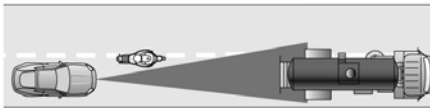

C

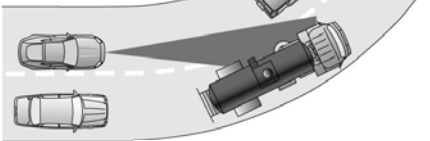

Detection issues can occur:

- A When driving on a different line than the vehicle in front.
- B With vehicles that edge into your lane. The system can only detect these vehicles once they fully move into your lane.
- C There may be issues with the detection of vehicles in front when driving into and coming out of a bend or curve in the road.

In these cases, the system may brake late or unexpectedly. You should stay alert and take action when necessary.

If something hits the front of your vehicle or damage occurs, the radar-sensing zone may change. This could cause missed or false vehicle detection

## System Not Available

- A blocked sensor.
- High brake temperature.
- A failure in the system or a related system.
- The system does not detect a lead vehicle after you stop, or driving at low speeds.

## Adaptive Cruise Control System Sensors



**WARNING:** The system may not operate properly if the sensor is blocked. Keep the windshield free from obstruction.



E243054

The camera is mounted behind the interior mirror.



E244279

The radar is behind the front grille below the license plate.

# Cruise Control

A message displays if something obstructs the radar signals from the sensor. The system cannot detect a vehicle ahead and does not function when something blocks the sensor.

**Note:** You cannot see the sensor, it is behind a fascia panel.

**Note:** Keep the front of your vehicle free of dirt, metal badges or objects. Vehicle front protectors, aftermarket lights, additional paint or plastic coatings could also degrade sensor performance.

Cause	Action
The surface of the radar in the radiator grille is dirty or obstructed.	Clean the radiator grille in front of the radar or remove any obstruction.
The surface of the radar is clean but the message remains in the display.	Wait a short period of time. It may take several minutes for the radar to detect that it is free from obstruction.
Heavy rain or snow interfere with the radar signals.	Do not use the system in these conditions because it may not detect any vehicles ahead.
Swirling water, snow or ice on the surface of the road interfere with the radar signals.	Do not use the system in these conditions because it may not detect any vehicles ahead.
You are in a desert or remote area with no other vehicles and no roadside objects.	Wait for a short period of time or switch to normal cruise control.

Due to the nature of radar technology, a blocked sensor message could display when the sensor is not blocked. This can happen, for example, when driving in sparse rural or desert environments. A false blocked condition self clears or clears after you switch the ignition off and on.

## Switching to Normal Cruise Control



**WARNING:** Normal cruise control will not brake when your vehicle is approaching slower vehicles. Always be aware of which mode you have selected and apply the brakes when necessary.

You can change from adaptive cruise control to cruise control using the information display.

# Cruise Control

**To switch between adaptive cruise control and normal cruise control, press the menu button on the steering wheel to enter the information display main menu and select the following:**

Menu Item	Action
Settings	Press the <b>OK</b> button.
Driver assistance	Press the <b>OK</b> button.
Cruise control	Press the <b>OK</b> button.
Normal	Select a setting and press the <b>OK</b> button.
Adaptive	
Intelligent	



The cruise control indicator replaces the adaptive cruise control indicator if you select normal cruise control. The gap setting does not display, the system does not automatically respond to lead vehicles and adaptive braking does not activate. The system remembers the last setting when you start your vehicle.

## Adaptive Cruise Control Indicator



The indicator appears when you switch the system on.

The indicator appears in the information display when the system is in standby mode and when you set the adaptive cruise speed.

## Adaptive Cruise Control Information Messages

Message	Action
Adaptive cruise control not available Sensor blocked See manual	The radar has reduced visibility.
Adaptive cruise control not available	The system is not available.
Adaptive cruise control malfunction	The system has malfunctioned. Have your vehicle checked as soon as possible.
Adaptive cruise control Speed too low to activate	You have switched the system on when your vehicle speed is too low.
Cruise control active Adaptive braking off	You have switched normal cruise control on. Adaptive braking turns off.

# Cruise Control

## Adaptive Cruise Control With Lane Centering



**WARNING:** You are responsible for controlling your vehicle at all times. The system is designed to be an aid and does not relieve you of your responsibility to drive with due care and attention. Failure to follow this instruction could result in the loss of control of your vehicle, personal injury or death.



**WARNING:** Pay close attention to changing road conditions such as entering or leaving a highway, on roads with intersections or roundabouts, roads without visible lanes of travel, roads that are winding, slippery, unpaved, or steep slopes.



**WARNING:** Do not use the system in poor visibility, for example fog, heavy rain, spray or snow.



**WARNING:** Large contrasts in outside lighting can limit sensor performance.



**WARNING:** The sensor may incorrectly track lane markings as other structures or objects. This can result in a false or missed warning.



**WARNING:** The system will not operate if the sensor cannot track the road lane markings.

The system is designed to help keep your vehicle in the center of the lane by applying continuous assistance steering torque input toward the lane center on highways.

**Note:** *The assistance steering torque is limited and may not be sufficient for all driving situations.*

**Note:** *In exceptional conditions, the system may deviate from the center line.*

The system only operates when the all of the following occur:

- You have adaptive cruise control with stop-and-go on.
- The system detects lane markings.
- Your hands are on the steering wheel at all times.
- The vehicle is centered in the lane.

**Note:** *The system may not function if the front camera or sensor is blocked or not available.*

## Switching Lane Centering On and Off



Press and release the button.

The indicator appears in the information display. When the system is on, the color of the indicator changes to indicate the system status.

Gray indicates the system is on but inactive.

Green indicates the system is active and applying assistance steering torque input to keep your vehicle in the center of the lane.

The system activates when it detects valid lane markings. If it does not detect valid lane markings, the system stays inactive until valid markings are available.

The system may not correctly operate in any of the following conditions:

- The lane is too narrow or wide.
- The system does not detect lane markings or when lanes merge or split.
- Limited steering torque input is applied.
- Areas under construction or new infrastructure.
- When modifications to the steering system have been made.
- When using a spare tire.

# Cruise Control

When the system is active and the direction indicator is switched on, the system immediately cancels. The system remains in standby mode as long as the direction indicator is engaged. The system re-activates automatically once the vehicle is centered in a lane and the direction indicator is switched off.

When the system is active and detects no steering activity for a certain period of time, the system alerts you to put your hands on the steering wheel. If you do not react to the warnings the system cancels and slows your vehicle down to idle speeds while maintaining steering control.

The system also alerts you if your vehicle crosses lane markings without detected steering activity.

**Note:** *The system may detect a light grip or touch on the steering wheel as hands off driving.*

You can override the system at any time by steering your vehicle.

## Automatic Cancellation



**WARNING:** Do not use the system if any changes or modifications to the steering wheel have been made. Any changes or modifications to the steering wheel could affect the functionality or performance of the system. Failure to follow this instruction could result in the loss of control of your vehicle, personal injury or death.

When the system is cancelled due to an external condition, for example, no lane markings are available and your hands are on the steering wheel, a tone sounds and a message appears in the information display.

When the system is cancelled due to an external condition, for example, no lane markings are available and your hands are not on the steering wheel, the system immediately alerts you to take control of the vehicle. If this alert is ignored, the system slows the vehicle while maintaining steering control.

**RES**

If your vehicle starts to slow down, you must contribute to the steering control and press and release the button or briefly press the accelerator pedal to regain full system performance.

Automatic cancellation can also occur if:

- The lane becomes too wide or narrow.
- The system cannot detect valid lane markings.
- Lane markings are crossed.
- The curve of the road is too sharp.

**Note:** *The system disables until the next key cycle if your vehicle slows down due to driver inactivity twice within a key cycle.*

## Blocked Sensors



**WARNING:** The system may not operate properly if the sensor is blocked. Keep the windshield free from obstruction.

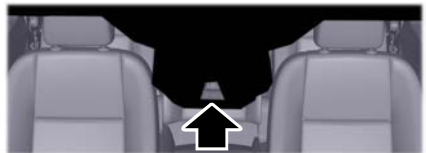

E243054

The camera is mounted behind the interior mirror.

# Cruise Control



E244279

The radar is behind the front grille below the license plate.

**Note:** You cannot see the radar, it is behind a fascia panel.

A message displays if something obstructs the radar signals from the sensor. The system cannot detect a vehicle ahead and does not function when something blocks the sensor.

**Note:** Keep the front of your vehicle free of dirt, metal badges or objects. Vehicle front protectors, aftermarket lights, additional paint or plastic coatings could also degrade sensor performance.

## Lane Centering Information Messages

Message	Action
Lane centring assist not available	The system is not available. If it is still not available the next time you switch the ignition on, the system has malfunctioned. Have your vehicle checked as soon as possible.

## Adaptive Cruise Control With Speed Sign Recognition (If Equipped)



**WARNING:** You are responsible for controlling your vehicle at all times. The system is designed to be an aid and does not relieve you of your responsibility to drive with due care and attention. Failure to follow this instruction could result in the loss of control of your vehicle, personal injury or death.

The system combines speed sign recognition with adaptive cruise control. The system allows you to set the vehicle speed to the speed limit detected by the speed sign recognition system. For example, if the speed sign recognition system detects a 80 km/h (50 mph) speed limit, the vehicle speed is set to 80 km/h (50 mph).

**Note:** The system does not set the vehicle speed to speed limits shown with a supplementary traffic sign in the information display.

**Note:** You can override the set speed at any time.

**Note:** The adaptive cruise control gap setting normally operates.

## Switching Between the Cruise Control Modes

You can change between the cruise control modes using the information display.

# Cruise Control

**To switch between the cruise control modes, press the menu button on the steering wheel to enter the information display main menu and select the following:**

Menu Item	Action
Settings	Press the <b>OK</b> button.
Driver assistance	Press the <b>OK</b> button.
Cruise control	Press the <b>OK</b> button.
Normal	Select a setting and press the <b>OK</b> button.
Adaptive	
Intelligent	

## Intelligent Mode



E265663

If you select this mode, a bracket appears around the set speed and the detected speed limit sign in the information display. The system is designed to set the vehicle speed to the speed limit detected by the speed sign recognition system before your vehicle passes the speed limit sign.

Under certain conditions, the system may not adjust the vehicle speed until after your vehicle passes the speed limit sign.

**Note:** *The set speed adjusts when the system detects a different maximum speed limit.*

If the system does not detect a speed limit, the vehicle speed remains at the current set speed.

### **Automatic Cancellation**

If the speed sign recognition system detects a speed limit below the minimum adaptive cruise control set speed, a tone sounds and the system returns to standby mode.

### **Adjusting the Set Speed Tolerance Settings**

You can set a permanent speed tolerance that is above or below the detected speed limit through the tolerance menu in the information display.

# Cruise Control

**To adjust the speed tolerance setting, press the menu button on the steering wheel to enter the information display main menu and select the following:**

Menu Item	Action
Settings	Press the <b>OK</b> button.
Driver assistance	Press the <b>OK</b> button.
Cruise control	Press the <b>OK</b> button.
Intelligent	Press the <b>OK</b> button.
Tolerance	Press the <b>OK</b> button. Select a setting and press the <b>OK</b> button.

## Adaptive Mode

If you select this mode, adaptive cruise control operates with manual set speed input. The system does not set the vehicle speed to the speed limit detected by the speed sign recognition system.

## Normal Mode

If you select this mode, normal cruise control operates. The gap setting does not display, the system does not automatically respond to lead vehicles and adaptive braking does not activate.

## Adaptive Cruise Control With Speed Sign Recognition Information Messages

Message	Action
Adaptive cruise control Speed sign recognition not available	Navigation system based speed limit information is not available. If the message continues to appear, have your vehicle checked as soon as possible.



# Driving Aids - Vehicles With: 4.2 Inch Instrument Cluster Display Screen

## INTELLIGENT SPEED LIMITER - VEHICLES WITHOUT: LANE CENTERING

### Principle of Operation



**WARNING:** When you are going downhill, your vehicle speed could increase above the set speed. The system does not apply the brakes.



**WARNING:** You are responsible for controlling your vehicle at all times. The system is designed to be an aid and does not relieve you of your responsibility to drive with due care and attention. Failure to follow this instruction could result in the loss of control of your vehicle, personal injury or death.

The system allows you to limit the vehicle speed to the maximum speed limit detected by the speed sign recognition system. For example, if the speed sign recognition system detects a 80 km/h (50 mph) speed limit, the vehicle speed is limited to 80 km/h (50 mph). You can temporarily exceed the set speed if required, for example to overtake.

**Note:** The system does not limit the vehicle speed to speed limits shown with a supplementary traffic sign in the information display.

### Using Intelligent Speed Limiter

The controls are on the steering wheel.

#### Switching the System On or Off

**LIM**

Press to switch the system on. The system activates with the detected speed-limit or, if no speed-limit is detected, the current vehicle speed as the set speed. Press again to switch the system off.

#### Setting the Speed Limiter

**SET+**

Press the toggle button upward or downward with the system in standby mode to set the speed limiter to the current vehicle speed. The set speed is stored and displayed in the information display.

**SET-**

**Note:** The set speed limiter adjusts when the system detects a different maximum speed limit.

**Note:** If the system cannot detect a maximum speed limit, the system returns to standby mode.

You can adjust the set speed in small or large increments. Press the toggle button upward or downward once to adjust the set speed in small increments. Press and hold the toggle button upward or downward to adjust the set speed in large increments.

#### Canceling the Set Speed

**CAN**

Press to cancel the set speed limiter. The system returns to standby mode.

**Note:** The speed limiter icon and the set speed indicator are greyed out in standby mode.

**Note:** The system does not limit the vehicle speed in standby mode.

#### Resuming the Set Speed

**RES**

Press to resume the set speed limiter. The system sets the speed limiter to the detected maximum speed limit at the time it resumes.

# Driving Aids - Vehicles With: 4.2 Inch Instrument Cluster Display Screen

## Intentionally Exceeding the Speed Limit

Firmly press the accelerator pedal to temporarily exceed the set speed limit. The system resumes when the vehicle speed drops below the set speed limit, or when you press the **RES** button.

## System Warnings

A warning appears in the information display if any of the following occur:

- The vehicle speed exceeds the current set speed.
- The system detects a maximum speed limit that is lower than the current vehicle speed.

- You intentionally exceed the set speed.
- You unintentionally exceed the set speed, for example when you are going downhill. A tone also sounds.

**Note:** *A tone sounds if you continue to exceed the set speed.*

**Note:** *If the speed sign recognition system detects a speed limit outside the operational speed range, a tone sounds and the system returns to standby mode.*

## Adjusting Intelligent Speed Limiter Tolerance Settings

You can set a permanent speed tolerance that is in addition to the detected speed limit through the tolerance menu in the information display.

**To adjust the speed tolerance setting, use the information display controls on the steering wheel to select the following:**

Menu Item	Action
Driver assist.	Press the menu button.
Speed limiter	Press the <b>OK</b> button.
Intelligent	Press the <b>OK</b> button.
Tolerance	Press the <b>OK</b> button. Press the toggle button upward or downward to choose your required speed setting. Press the <b>OK</b> button.

## Switching to Normal Speed Limiter

You can change between intelligent speed limiter and normal speed limiter using the information display. Intelligent speed limiter allows you to limit the vehicle speed to the maximum speed limit detected by the speed sign recognition system. Normal speed limiter allows you to manually limit the vehicle speed using controls on the steering wheel.

# Driving Aids - Vehicles With: 4.2 Inch Instrument Cluster Display Screen

**To switch between intelligent speed limiter and normal speed limiter, use the information display controls on the steering wheel to select the following:**

Menu Item	Action
Driver assist.	Press the menu button.
Speed limiter	Press the <b>OK</b> button.
Intelligent	Press the <b>OK</b> button.

**Note:** *If you switch intelligent speed limiter off, the system defaults to manual speed limiter. You can manually set the speed limiter using the controls on the steering wheel.*

## INTELLIGENT SPEED LIMITER - VEHICLES WITH: LANE CENTERING

### Principle of Operation



**WARNING:** When you are going downhill, your vehicle speed could increase above the set speed. The system does not apply the brakes.



**WARNING:** You are responsible for controlling your vehicle at all times. The system is designed to be an aid and does not relieve you of your responsibility to drive with due care and attention. Failure to follow this instruction could result in the loss of control of your vehicle, personal injury or death.

The system allows you to limit the vehicle speed to the maximum speed limit detected by the speed sign recognition system. For example, if the speed sign recognition system detects a 80 km/h (50 mph) speed limit, the vehicle speed is limited to 80 km/h (50 mph). You can temporarily exceed the set speed if required, for example to overtake.

**Note:** *The system does not limit the vehicle speed to speed limits shown with a supplementary traffic sign in the information display.*

### Using Intelligent Speed Limiter

The controls are on the steering wheel.

#### Switching the System On or Off



Press to switch the system on. The system activates with the detected speed-limit or, if no speed-limit is detected, the current vehicle speed as the set speed. Press again with the system in standby mode to switch the system off.

#### Setting the Speed Limiter



Press the toggle button upward or downward with the system in standby mode to set the speed limiter to the current vehicle speed. The set speed is stored and displayed in the information

display.

# Driving Aids - Vehicles With: 4.2 Inch Instrument Cluster Display Screen

---

**Note:** The set speed limiter adjusts when the system detects a different maximum speed limit.

**Note:** If the system cannot detect a maximum speed limit, the system returns to standby mode.

You can adjust the set speed in small or large increments. Press the toggle button upward or downward once to adjust the set speed in small increments. Press and hold the toggle button upward or downward to adjust the set speed in large increments.

## Canceling the Set Speed

**LIM** Press to cancel the set speed limiter. The system returns to standby mode.

**Note:** The speed limiter icon and the set speed indicator are greyed out in standby mode.

**Note:** The system does not limit the vehicle speed in standby mode.

## Resuming the Set Speed

**RES** Press to resume the set speed limiter. The system sets the speed limiter to the detected maximum speed limit at the time it resumes.

## Intentionally Exceeding the Speed Limit

Firmly press the accelerator pedal to temporarily exceed the set speed limit. The system resumes when the vehicle speed drops below the set speed limit, or when you press the **RES** button.

## System Warnings

A warning appears in the information display if any of the following occur:

- The vehicle speed exceeds the current set speed.
- The system detects a maximum speed limit that is lower than the current vehicle speed.
- You intentionally exceed the set speed.
- You unintentionally exceed the set speed, for example when you are going downhill. A tone also sounds.

**Note:** A tone sounds if you continue to exceed the set speed.

**Note:** If the speed sign recognition system detects a speed limit outside the operational speed range, a tone sounds and the system returns to standby mode.

## Adjusting Intelligent Speed Limiter Tolerance Settings

You can set a permanent speed tolerance that is in addition to the detected speed limit through the tolerance menu in the information display.

## Driving Aids - Vehicles With: 4.2 Inch Instrument Cluster Display Screen

**To adjust the speed tolerance setting, use the information display controls on the steering wheel to select the following:**

Menu Item	Action
Driver assist.	Press the menu button.
Speed limiter	Press the <b>OK</b> button.
Intelligent	Press the <b>OK</b> button.
Tolerance	Press the <b>OK</b> button. Press the toggle button upward or downward to choose your required speed setting. Press the <b>OK</b> button.

### Switching to Normal Speed Limiter

You can change between intelligent speed limiter and normal speed limiter using the information display. Intelligent speed limiter allows you to limit the vehicle speed to the maximum speed limit detected by the speed sign recognition system. Normal speed limiter allows you to manually limit the vehicle speed using controls on the steering wheel.

**To switch between intelligent speed limiter and normal speed limiter, use the information display controls on the steering wheel to select the following:**

Menu Item	Action
Driver assist.	Press the menu button.
Speed limiter	Press the <b>OK</b> button.
Intelligent	Press the <b>OK</b> button.

**Note:** *If you switch intelligent speed limiter off, the system defaults to manual speed limiter. You can manually set the speed limiter using the controls on the steering wheel.*

# Driving Aids - Vehicles With: 4.2 Inch Instrument Cluster Display Screen

## DRIVER ALERT



**WARNING:** You are responsible for controlling your vehicle at all times. The system is designed to be an aid and does not relieve you of your responsibility to drive with due care and attention. Failure to follow this instruction could result in the loss of control of your vehicle, personal injury or death.



**WARNING:** The system may not operate properly if the sensor is blocked. Keep the windshield free from obstruction.



**WARNING:** Take regular rest breaks if you feel tired. Do not wait for the system to warn you.



**WARNING:** Certain driving styles may result in the system warning you even if you are not feeling tired.



**WARNING:** In cold and severe weather conditions the system may not function. Rain, snow and spray can all limit sensor performance.



**WARNING:** The system will not operate if the sensor cannot track the road lane markings.



**WARNING:** If damage occurs in the immediate area surrounding the sensor, have your vehicle checked as soon as possible.



**WARNING:** The system may not correctly operate if your vehicle is fitted with a suspension kit not approved by us.

The system is designed to alert you if it calculates that you are becoming drowsy or if your driving deteriorates.

The system calculates your alertness level based upon your driving behavior in relation to the lane markings and other factors when the vehicle speed is greater than approximately 65 km/h (40 mph).

### Driver Alert System Warnings

The warning system has two stages:

1. A temporary warning is issued to advise you to take a rest. This message only appears for a short time.
2. If you do not rest and the system continues to detect that your driving deteriorates, it issues a further warning. This remains in the information display until you cancel it.

**Note:** *The system does not warn you if the vehicle speed falls below approximately 65 km/h (40 mph).*

### Driver Alert System Display

1. Using the information display controls on the steering wheel, select **Settings**.
2. Select **Information**.
3. Select **Driver alert**.

Your calculated alertness level is shown by six steps as a colored bar. The bar travels from right to left as your calculated alertness level decreases.

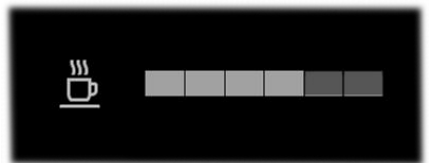

E249476

Your calculated alertness level is good.

# Driving Aids - Vehicles With: 4.2 Inch Instrument Cluster Display Screen



E249477

Your calculated alertness level is low. You should stop your vehicle and take a rest as soon as it is safe to do so.

Your calculated alertness level shows in gray if:

- The sensor cannot track the road lane markings.
- The vehicle speed is less than approximately 65 km/h (40 mph).

## Driver Alert System Messages

Message	Action
Driver fatigue warning Rest suggested	Displays when we recommend that you take a break due to low alertness levels.
Driver fatigue warning Rest now	Displays when you must take a break due to low alertness levels.

## LANE KEEPING SYSTEM



**WARNING:** You are responsible for controlling your vehicle at all times. The system is designed to be an aid and does not relieve you of your responsibility to drive with due care and attention. Failure to follow this instruction could result in the loss of control of your vehicle, personal injury or death.



**WARNING:** The system may not function if the sensor is blocked.

## Switching Driver Alert On and Off

1. Using the information display controls on the steering wheel, select **Driver assist**.
2. Switch **Driver Alert** on or off.

**Note:** *The system remains on or off depending on how it was last set.*

## Resetting Driver Alert

You can reset the system by:

- Switching the ignition off and on when your vehicle is stationary.
- Opening and closing the driver door when your vehicle is stationary.



**WARNING:** The sensor may incorrectly track lane markings as other structures or objects. This can result in a false or missed warning.



**WARNING:** In cold and severe weather conditions the system may not function. Rain, snow and spray can all limit sensor performance.



**WARNING:** Large contrasts in outside lighting can limit sensor performance.

## Driving Aids - Vehicles With: 4.2 Inch Instrument Cluster Display Screen



**WARNING:** The system will not operate if the sensor cannot track the road lane markings.



**WARNING:** If damage occurs in the immediate area surrounding the sensor, have your vehicle checked as soon as possible.



**WARNING:** The system may not correctly operate if your vehicle is fitted with a suspension kit not approved by us.

The system is designed to alert you by providing temporary steering assistance or steering wheel vibration when it detects an unintended lane departure. The system detects and tracks the road lane markings using a camera mounted behind the interior mirror. The system only operates when the vehicle speed is greater than approximately 65 km/h (40 mph). You can view the system status in the information display.

**Note:** *The system works when the camera can detect at least one lane marking or the edge of the road.*

The system may not correctly operate in any of the following conditions:

- The system does not detect at least one lane marking or the edge of the road.
- You switch the direction indicator on.
- You apply direct steering, accelerate fast or brake hard.
- The vehicle speed is less than 65 km/h (40 mph).
- The anti-lock brake, stability control or traction control system activates.
- Narrow lane width.

The system may not correct lane positioning in any of the following conditions:

- High winds.
- Uneven road surfaces.
- Heavy or uneven loads.
- Incorrect tire pressure.

### Switching Lane Keeping System On and Off



E270719

Press the button on the direction indicator stalk.

### Lane Keeping System Settings

The system has different settings that you can view or adjust using the information display.

**Note:** *The system remembers the last setting when you start your vehicle. If the system detects a MyKey, the mode is set to alert.*

#### Alert Mode

Provides steering wheel vibration when the system detects an unintended lane departure.



# Driving Aids - Vehicles With: 4.2 Inch Instrument Cluster Display Screen

## Adjusting the Steering Wheel Vibration Intensity

1. Using the information display controls on the steering wheel, select **Driver assist..**
2. Select **Lane keeping system.**
3. Select **Intensity.**
4. Select a setting and press the **OK** button.

**Note:** This setting does not affect the aid mode.

**Note:** The system remembers the last setting when you start your vehicle.

## Adjusting the Lane Keeping System Sensitivity

1. Using the information display controls on the steering wheel, select **Driver assist..**
2. Select **Lane keeping system.**
3. Select **Sensitivity.**
4. Select a setting and press the **OK** button.

## Aid Mode

Provides temporary steering assistance toward the lane center when the system detects an unintended lane departure.

**Note:** When aid mode is on and the system does not detect any steering activity for a short period of time, for example lightly holding the steering wheel, the system alerts you to put your hands on the steering wheel.

**Note:** The aid mode becomes active again after you have returned your vehicle to the center of the lane.

## Alert and Aid Mode

Provides temporary steering assistance toward the lane center when the system detects an unintended lane departure. If your vehicle continues drifting out of the lane, the steering wheel vibrates.

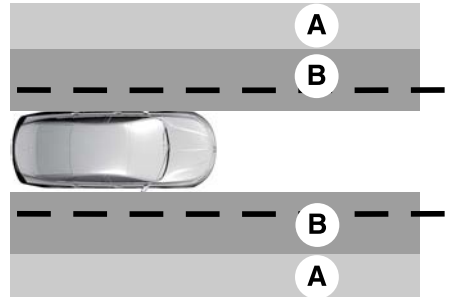

A Alert mode.

B Aid mode.

**Note:** The diagram illustrates general zone coverage. It does not provide exact zone parameters.

## Switching the Lane Keeping System Mode

1. Using the information display controls on the steering wheel, select **Driver assist..**
2. Select **Lane keeping system.**
3. Select **Mode.**
4. Select a setting and press the **OK** button.

# Driving Aids - Vehicles With: 4.2 Inch Instrument Cluster Display Screen

## Lane Keeping System Display



When the system is off, the system indicator or the lane markings do not display.

### Lane Keeping System Indicators



It illuminates in the information display when you switch the system on and Aid Mode or Alert and Aid Mode are selected.



It illuminates in the information display when you switch the system on and Alert Mode is selected.

## Black and White Information Display

Indicator	System Status
Gray.	Unavailable.
White.	Available.
White and inverted.	Temporary steering assistance.
White and flashing.	Temporary steering assistance and steering wheel vibration.

## Color Information Display

Indicator	System Status
Gray.	Unavailable.
Green.	Available.
Amber.	Temporary steering assistance.
Red.	Temporary steering assistance and steering wheel vibration.

## Lane Keeping System Warning Lamp



It could illuminate when you switch the system off. If it illuminates when you are driving, this indicates a malfunction. Have your vehicle checked as soon as possible.

# Driving Aids - Vehicles With: 4.2 Inch Instrument Cluster Display Screen

## Lane Keeping System Messages

Message	Action
Lane keeping system malfunction Service required	The system has detected a fault that requires service. Have your vehicle checked as soon as possible.

## BLIND SPOT INFORMATION SYSTEM

 **WARNING:** Do not use the blind spot information system as a replacement for using the interior and exterior mirrors or looking over your shoulder before changing lanes. The blind spot information system is not a replacement for careful driving.

 **WARNING:** The system may not operate properly during severe weather conditions, for example snow, ice, heavy rain and spray. Always drive with due care and attention. Failure to take care may result in a crash.

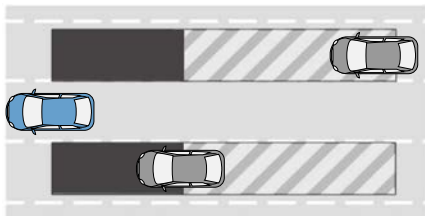

The system is designed to detect vehicles that may have entered the blind spot zone. The detection area is on both sides of your vehicle, extending rearward from the exterior mirrors to approximately 4 m (13 ft) beyond the rear bumper. The detection area extends to approximately 18 m (59 ft) beyond the rear bumper when the vehicle speed is greater than 48 km/h (30 mph) to alert you of faster approaching vehicles.

**Note:** *The system does not prevent contact with other vehicles. It is not designed to detect parked vehicles, pedestrians, animals or other infrastructures.*

### Using the Blind Spot Information System

#### Vehicles with Automatic Transmission

The system turns on when all of the following occur:

- You start your vehicle.
- You shift into drive (D).
- The vehicle speed is greater than 10 km/h (6 mph).

**Note:** *The system does not operate in park (P) or reverse (R).*

#### Vehicles with Manual Transmission

The system turns on when all of the following occur:

- You start your vehicle.
- The vehicle speed is greater than 10 km/h (6 mph).

## Driving Aids - Vehicles With: 4.2 Inch Instrument Cluster Display Screen

**Note:** The system does not operate in reverse (R).

### Blind Spot Information System Sensors



The sensors are behind the rear bumper on both sides of your vehicle.

**Note:** Keep the sensors free from snow, ice and large accumulations of dirt.

**Note:** Do not cover the sensors with bumper stickers, repair compound or other objects.

**Note:** Blocked sensors could affect system performance.

If the sensors are blocked, a message may appear in the information display. The alert indicators remain illuminated but the system does not alert you.

### Switching the Blind Spot Information System On and Off

1. Using the information display controls on the steering wheel, select **Settings**.
2. Select **Driver assistance**.
3. Switch **BLIS** on or off.

If you switch the system off, a warning lamp illuminates and a message displays. When you switch the system on or off, the alert indicators flash twice.

**Note:** The system remembers the last setting when you start your vehicle.

**Note:** The system may not correctly operate when towing a trailer. For vehicles with a trailer tow module and tow bar approved by us, the system turns off when you attach a trailer. For vehicles with an aftermarket trailer tow module or tow bar, we recommend that you switch the system off when you attach a trailer.

To permanently switch the system off, contact an authorized dealer.

### Blind Spot Information System Indicator



When the system detects a vehicle, an alert indicator illuminates in the exterior mirror on the side the approaching vehicle is coming from. If you turn the direction indicator on for that side of your vehicle, the alert indicator flashes.

If the system detects a fault, an indicator illuminates in the instrument cluster and a message appears in the information display. Have your vehicle checked as soon as possible.

**Note:** The system may not alert you if a vehicle quickly passes through the detection zone.

# Driving Aids - Vehicles With: 4.2 Inch Instrument Cluster Display Screen

## Blind Spot Information System Information Messages

Message	Action
BLIS not available Sensor blocked See manual	Displays if the blind spot information system sensors are blocked.
BLIS deactivated Trailer attached	Displays if you attach a trailer to your vehicle.
BLIS malfunction	The system has detected a fault that requires service. Have your vehicle checked as soon as possible.

## CROSS TRAFFIC ALERT



**WARNING:** Do not use the cross traffic alert system as a replacement for using the interior and exterior mirrors or looking over your shoulder before reversing out of a parking space. The cross traffic alert system is not a replacement for careful driving.



**WARNING:** The system may not operate properly during severe weather conditions, for example snow, ice, heavy rain and spray. Always drive with due care and attention. Failure to take care may result in a crash.

The system is designed to alert you of vehicles approaching from the sides behind your vehicle when you shift into reverse (R). If you continue to reverse after the system alerts you, the system is designed to apply the brakes if it still detects an approaching vehicle. If the system applies the brakes, a message appears in the information display.

**Note:** *The system does not apply the brakes if you override it by firmly pressing the accelerator pedal.*

### Using Cross Traffic Alert

The system is designed to detect vehicles that approach at a speed between 6 km/h (4 mph) and 60 km/h (37 mph). Coverage decreases when the sensors are partially, mostly or fully obstructed. Slowly reversing helps increase the coverage area and effectiveness.

The system turns on when you start the engine and you shift into reverse (R). The system turns off when you shift out of reverse (R).

## Driving Aids - Vehicles With: 4.2 Inch Instrument Cluster Display Screen

---

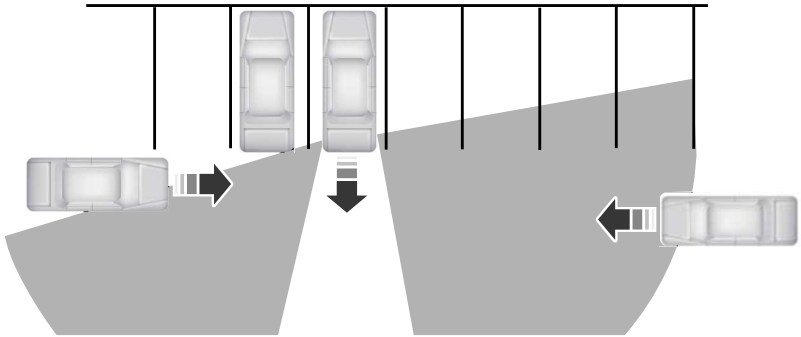

The sensor on the left-hand side is only partially obstructed and zone coverage on the right-hand side is maximized.

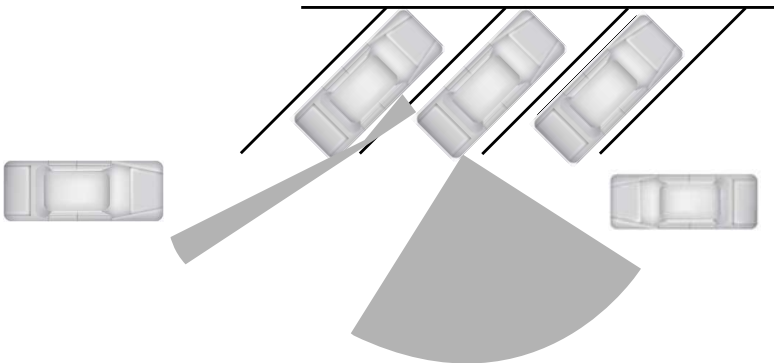

# Driving Aids - Vehicles With: 4.2 Inch Instrument Cluster Display Screen

Zone coverage also decreases when parking at narrow angles. The sensor on the left-hand side is mostly obstructed and zone coverage on that side is severely reduced.

## Cross Traffic Alert System Sensors

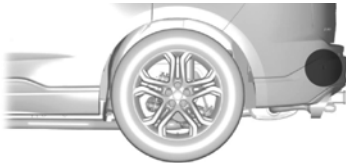

The sensors are behind the rear bumper on both sides of your vehicle.

**Note:** *Keep the sensors free from snow, ice and large accumulations of dirt.*

**Note:** *Do not cover the sensors with bumper stickers, repair compound or other objects.*

## Switching Cross Traffic Alert On or Off

**To switch cross traffic alert on or off, use the information display controls on the steering wheel to select the following:**

Menu Item	Action
Driver assist.	Press the menu button.
Cross traffic alert	Press the <b>OK</b> button.

**Note:** *If you temporarily switch the system off, it turns on the next time you switch the ignition on.*

**Note:** *The system may not correctly operate when towing a trailer. For vehicles with a trailer tow module and tow bar approved by us, the system turns off when you attach a trailer. For vehicles with an aftermarket trailer tow module or tow bar, we recommend that you switch the system off when you attach a trailer.*

**Note:** *Blocked sensors could affect system performance.*

If the sensors are blocked, a message may appear in the information display when you shift into reverse (R).

## Cross Traffic Alert System Limitations

The system may not correctly operate when any of the following occur:

- The sensors are blocked.
- Adjacently parked vehicles or objects are obstructing the sensors.
- Vehicles approach at speeds less than 6 km/h (4 mph) or greater than 60 km/h (37 mph).
- The vehicle speed is greater than 12 km/h (7 mph).
- You reverse out of an angled parking space.

To permanently switch the system off, contact an authorized dealer.

## Cross Traffic Alert Indicator



When the system detects an approaching vehicle a tone sounds, an indicator illuminates in the relevant exterior mirror and arrows appear in the information display to show which side the approaching vehicle is coming from.

# Driving Aids - Vehicles With: 4.2 Inch Instrument Cluster Display Screen

**Note:** If arrows do not display, a message appears in the information display.

If the system malfunctions, an indicator illuminates in the instrument cluster and a message appears in the information display. Have your vehicle checked as soon as possible.

**Note:** In exceptional conditions, the system could alert you or apply the brakes, even when there is nothing in the detection zone, for example a vehicle passing further away from your vehicle.

## Cross Traffic Alert Information Messages

Message	Action
Cross traffic alert	Displays instead of indication arrows when the system detects a vehicle. Check for approaching traffic.
Cross traffic not available Sensor blocked See manual	Displays if the cross traffic alert system sensors are blocked. Clean the sensors. If the message continues to appear, have your vehicle checked as soon as possible.
Cross traffic malfunction	The system has malfunctioned. Have your vehicle checked as soon as possible.
Cross traffic alert deactivated Trailer attached	Displays if you attach a trailer to your vehicle.
Cross traffic alert Applying brakes	Displays if the system applies the brakes. Check for approaching traffic.

## TRAFFIC SIGN RECOGNITION

### Principle of Operation



**WARNING:** You are responsible for controlling your vehicle at all times. The system is designed to be an aid and does not relieve you of your responsibility to drive with due care and attention. Failure to follow this instruction could result in the loss of control of your vehicle, personal injury or death.



**WARNING:** The system may not operate properly if the sensor is blocked. Keep the windshield free from obstruction.

The system is designed to detect traffic signs to inform you of the current speed limit and overtaking regulations. Detected traffic signs appear in the information display. The sensor is behind the interior mirror.

**Note:** Do not carry out windshield repairs in the immediate area surrounding the sensor.

**Note:** Traffic sign data provided by the navigation system contains information integrated to the data carrier release.

The system detects recognizable traffic signs, for example:

- Speed limit signs.
- No overtaking signs.
- Speed limit cancellation signs.
- No overtaking cancellation signs.



## Driving Aids - Vehicles With: 4.2 Inch Instrument Cluster Display Screen

**Note:** The system may not detect all traffic signs and may incorrectly read signs.

**Note:** In cold and severe weather conditions the system may not function. Rain, snow, spray and large contrasts in lighting can all prevent the sensor from correctly functioning.

**Note:** If your vehicle has a suspension kit not approved by us, the system may not correctly function.

**Note:** Always fit Ford original parts when replacing headlamp bulbs. Other bulbs may reduce system performance.

The system turns on when you switch the ignition on and you cannot switch the system off.

### Switching Speed Warning On and Off

1. Using the information display controls on the steering wheel, select **Driver assist**.
2. Select **Traffic sign recognition**.
3. Select **Activate Traff. Sign Recog.**
4. Select **Activate speed warning**.
5. Switch **Overspeed chime** on or off.

### Setting the Speed Warning

You can set the system speed warning to alert you when the vehicle speed exceeds the speed limit recognized by the system by a certain speed tolerance.

1. Using the information display controls on the steering wheel, select **Driver assist**.
2. Select **Traffic sign recognition**.
3. Select **Activate Traff. Sign Recog.**

4. Select **Activate speed warning**.
5. Select **Speed warning**.
6. Select a setting and press the **OK** button.

### Traffic Sign Recognition System Display



The system can display two traffic signs in parallel.

You can view the status at any time using the information display.

The system displays recognizable traffic signs in four stages as follows:

1. All new traffic signs appear brighter than the others in the display.
2. After a predetermined time they display normally.
3. After a predetermined distance they are greyed out.
4. After another predetermined distance they are deleted.

If the system detects a supplementary traffic sign, it displays below the respective traffic sign. For example, when passing a reduced speed limit in wet road conditions sign.

**Note:** If your vehicle has a navigation system, stored traffic sign data may influence the indicated speed limit value.

# Driving Aids - Vehicles With: 4.2 Inch Instrument Cluster Display Screen

## Traffic Sign Recognition System Messages

Message	Action
Traffic sign recognition Reduced performance See manual	The traffic sign data provided by the navigation system is unavailable due to weak or no signal. Wait for a short period of time for the signal to improve. If the message continues to appear, have your vehicle checked as soon as possible.

## SPEED SIGN RECOGNITION

### Principle of Operation



**WARNING:** You are responsible for controlling your vehicle at all times. The system is designed to be an aid and does not relieve you of your responsibility to drive with due care and attention. Failure to follow this instruction could result in the loss of control of your vehicle, personal injury or death.



**WARNING:** The system may not operate properly if the sensor is blocked. Keep the windshield free from obstruction.

The system is designed to detect speed limit signs to inform you of the current speed limit. Detected speed signs appear in the information display. The sensor is behind the interior mirror.

**Note:** Do not carry out windshield repairs in the immediate area surrounding the sensor.

**Note:** Speed sign data provided by the navigation system contains information integrated to the data carrier release.

**Note:** The system may not detect all speed signs and may incorrectly read signs.

**Note:** In cold and severe weather conditions the system may not function. Rain, snow, spray and large contrasts in lighting can all prevent the sensor from correctly functioning.

**Note:** If your vehicle has a suspension kit not approved by us, the system may not correctly function.

**Note:** Always fit Ford original parts when replacing headlamp bulbs. Other bulbs may reduce system performance.

The system turns on when you switch the ignition on and you cannot switch the system off.

### Using Speed Sign Recognition

#### Switching Speed Warning On and Off

1. Using the information display controls on the steering wheel, select **Driver assist..**
2. Select **Traffic sign recognition.**
3. Select **Activate Traff. Sign Recog..**
4. Select **Activate speed warning.**
5. Switch **Overspeed chime** on or off.

#### Setting the System Speed Warning

You can set the system speed warning to alert you when the vehicle speed exceeds the speed limit recognized by the system by a certain speed tolerance.

1. Using the information display controls on the steering wheel, select **Driver assist..**

# Driving Aids - Vehicles With: 4.2 Inch Instrument Cluster Display Screen

2. Select **Traffic sign recognition**.
3. Select **Activate Traff. Sign Recog.**
4. Select **Activate speed warning**.
5. Select **Speed warning**.
6. Select a setting and press the **OK** button.

**Note:** *The system remembers the last setting when you start your vehicle.*

## Speed Sign Recognition System Display



When the system detects a speed limit sign, the speed limit appears in the information display.

**Note:** *If your vehicle has a navigation system, stored speed sign data could influence the indicated speed limit value.*

## Speed Sign Recognition System Messages

Message	Action
Traffic sign recognition Reduced performance See manual	The traffic sign data provided by the navigation system is unavailable due to weak or no signal. Wait for a short period of time for the signal to improve. If the message continues to appear, have your vehicle checked as soon as possible.

## WRONG WAY ALERT



**WARNING:** The system is designed to aid the driver. It is not intended to replace your attention and judgment. You are still responsible to drive with due care and attention.



**WARNING:** At all times, you are responsible for controlling your vehicle, supervising the system and intervening, if required. Failure to take care may result in the loss of control of your vehicle, serious personal injury or death.



**WARNING:** The system may not operate properly if the sensor is blocked. Keep the windshield free from obstruction.

The system is designed to alert you if it detects that you are driving the wrong way on a freeway exit road. The system uses a sensor behind the interior mirror to detect no entry signs and uses information from the navigation system.

**Note:** *Do not carry out windshield repairs in the immediate area surrounding the sensor.*

## Driving Aids - Vehicles With: 4.2 Inch Instrument Cluster Display Screen

**Note:** Traffic sign data provided by the navigation system contains information integrated to the data carrier release.

**Note:** The system is designed to detect traffic signs meeting the Vienna convention.

**Note:** The system may not detect all traffic signs and may incorrectly read signs.

**Note:** If your vehicle has a suspension kit not approved by us, the system may not correctly function.

**Note:** Always fit Ford original parts when replacing headlamp bulbs. Other bulbs may reduce system performance.

**Note:** The system does not operate in some countries. We recommend that you check system availability before use.

If the system detects that you are driving the wrong way on a freeway exit road, a message appears in the information display and a tone sounds. The audio system volume mutes and navigation system guidance pauses.

**Note:** In cold and severe weather conditions the system may not function. Rain, snow, spray and large contrasts in lighting can all prevent the sensor from functioning correctly.

**Note:** The system may not correctly operate in areas under construction or new infrastructure.

**Note:** In exceptional conditions, the system could alert you even if you are not driving the wrong way on a freeway exit road.

### Switching Wrong Way Alert On or Off

To switch wrong way alert on or off, use the information display controls on the steering wheel to select the following:

Menu Item	Action
Driver assist.	Press the menu button.
Wrong way alert	Press the <b>OK</b> button.

**Note:** The system remembers the last setting when you start your vehicle.

### Wrong Way Alert Information Messages

Message	Action
Check driving direction	The system has detected that you are driving the wrong way on a freeway exit road. Press the <b>OK</b> button.

# Driving Aids - Vehicles With: 4.2 Inch Instrument Cluster Display Screen

## ECO

### Eco Mode

#### How Does Eco Mode Work

The system is designed to monitor certain driving characteristics to help you drive more efficiently. See **Driving Economically** (page 388).

**Note:** *The efficiency levels do not result in a defined fuel consumption figure. See **Fuel Consumption** (page 221).*

**Note:** *The system only indicates the efficiency level for the current trip. The system resets each time you switch the ignition on.*

#### Instantaneous Efficiency Level

The display ring increases as the instantaneous efficiency level increases and illuminates when it reaches maximum efficiency. The level continuously updates to indicate the efficiency level for the current trip.

## STEERING

### Steering Information Messages

Message	Description
Steering assist malfunction Service required	The system has malfunctioned. Stop your vehicle as soon as it is safe to do so. You will continue to have full steering but will need to exert greater force on the steering wheel. Have your vehicle checked as soon as possible.

#### Viewing the Instantaneous Efficiency Level

1. Using the information display controls on the steering wheel, select **MyView**.
2. Select **Eco coach**.

#### Trip Summary

The calculated trip summary is shown as four colored bars. The bars travel from left to right as the calculated efficiency levels increase. The bars indicate the average efficiency level for acceleration, deceleration, speed and gear shifting during the total distance traveled by your vehicle for the current trip.

**Note:** *Vehicles with an automatic transmission do not have a bar for gear shifting.*

#### Viewing the Trip Summary

1. Using the information display controls on the steering wheel, select **MyView**.
2. Select **Eco coach**.

# Driving Aids - Vehicles With: 4.2 Inch Instrument Cluster Display Screen

## PRE-COLLISION ASSIST



**WARNING:** You are responsible for controlling your vehicle at all times. The system is designed to be an aid and does not relieve you of your responsibility to drive with due care and attention. Failure to follow this instruction could result in the loss of control of your vehicle, personal injury or death.



**WARNING:** The system does not operate during hard acceleration or steering. Failure to take care may lead to a crash or personal injury.



**WARNING:** The system may fail or operate with reduced function during cold and severe weather conditions. Snow, ice, rain, spray and fog can adversely affect the system. Keep the front camera and radar free of snow and ice. Failure to take care may result in the loss of control of your vehicle, serious personal injury or death.



**WARNING:** The system may not operate properly if your vehicle has a non-Ford windshield. Do not carry out windshield repairs in the area around the sensor.



**WARNING:** System performance could be reduced in situations where the vehicle camera has limited detection capability. These situations include but are not limited to direct or low sunlight, vehicles at night without tail lights,

unconventional vehicle types, pedestrians or cyclists with complex backgrounds, running pedestrians or fast moving cyclists, partly obscured pedestrians or cyclists, pedestrians or cyclists that the system cannot distinguish from a group. Failure to take care may result in the loss of control of your vehicle, personal injury or death.



**WARNING:** The Pre-Collision Assist system with brake support cannot help prevent all collisions. Do not rely on this system to replace your judgment and the need to maintain correct distance and speed.

The pre-collision assist system is active when your vehicle reaches a speed greater than approximately 5 km/h (3 mph). Pedestrian and cyclist detection is active at speeds up to 80 km/h (50 mph).

**Note:** *The system is not designed to detect animals.*

**Note:** *The system is not designed to detect vehicles that are traveling in a different direction.*



E156130

If your vehicle is rapidly approaching another stationary vehicle, a vehicle traveling in the same direction as yours, a pedestrian or a cyclist within your driving path, the system is designed to provide three levels of functionality.

# Driving Aids - Vehicles With: 4.2 Inch Instrument Cluster Display Screen

Level of Functionality	Description
Alert	When activated, a warning lamp flashes and an audible warning sounds.
Brake support	The system is designed to help reduce the impact speed by preparing the brakes for rapid braking. The system does not automatically apply the brakes. If you press the brake pedal, the system could apply additional braking up to maximum braking force, even if you lightly press the brake pedal.
Active braking - vehicles without adaptive cruise control	The system is designed to apply the brakes if it detects a crash is imminent. This may help reduce impact or avoid the crash. The system is active at speeds up to 130 km/h (80 mph).
Active braking - vehicles with adaptive cruise control	The system is designed to apply the brakes if it detects a crash is imminent. This may help reduce impact or avoid the crash.

## Switching Active Braking On and Off

1. Using the information display controls on the steering wheel, select **Driver assist**.
2. Select **Pre-collision Assist**.
3. Switch **Active braking** on or off.

### Distance Alert (If Equipped)

A warning lamp illuminates if the distance to the vehicle ahead is small.

**Note:** *The warning lamp does not illuminate if cruise control or adaptive cruise control is active.*

## Setting the Distance Alert Sensitivity

1. Using the information display controls on the steering wheel, select **Driver assist**.
2. Select **Pre-collision Assist**.
3. Select **Alert sensitivity**.
4. Select a setting and press the **OK** button.

### Distance Indication (If Equipped)

A graphical indication displays the time gap to vehicles ahead of you traveling in the same direction.

**Note:** *The graphic does not display if you switch on cruise control or adaptive cruise control.*

# Driving Aids - Vehicles With: 4.2 Inch Instrument Cluster Display Screen

Vehicle Speed	System Sensitivity	Distance Indicator Color	Distance Gap	Time Gap
100 km/h (62 mph)	Normal.	Gray.	Greater than 25 m (82.0 ft) .	Greater than 0.9 seconds.
		Yellow.	17–25 m (55.8–82.0 ft).	0.6–0.9 seconds.
		Red.	Less than 17 m (55.8 ft).	Less than 0.6 seconds.

## Switching Distance Indication On and Off

- Using the information display controls on the steering wheel, select **Driver assist.**
- Select **Pre-collision Assist.**
- Switch **Distance indication** on or off.

## Pre-Collision Assist System Sensors

### Vehicles without Adaptive Cruise Control



E243054

The camera is mounted behind the interior mirror.

**Note:** Keep the sensors free from snow, ice and large accumulations of dirt.

**Note:** Do not clean the sensors with sharp objects.

**Note:** If your vehicle sustains damage leaving the sensors misaligned, this may cause inaccurate measurements or false alerts.

Blocked sensors could affect system accuracy. A message may appear in the information display.

### Vehicles with Adaptive Cruise Control



E243054

The camera is mounted behind the interior mirror.



E244279



## Driving Aids - Vehicles With: 4.2 Inch Instrument Cluster Display Screen

The radar sensor is behind the front grille below the license plate.

**Note:** *Keep the sensors free from snow, ice and large accumulations of dirt.*

**Note:** *Do not clean the sensors with sharp objects.*

**Note:** *If your vehicle sustains damage leaving the sensors misaligned, this may cause inaccurate measurements or false alerts.*

Blocked sensors could affect system accuracy. A message may appear in the information display.

### Pre-Collision Assist Warning Lamp



It illuminates if your vehicle rapidly approaches another vehicle, to warn you of the risk of a crash with the vehicle in front of you.

It could illuminate red if the distance to the vehicle ahead is small.

It illuminates when the system is not available.

### Pre-Collision Assist Information Messages

Message	Action
Pre-collision assist not available	The system has malfunctioned. Have your vehicle checked as soon as possible.
Pre-collision assist not available Sensor blocked	The sensors are dirty. Clean the sensors. If the message continues to appear, have your vehicle checked as soon as possible.

**The following table lists possible causes and actions for when a blocked sensor message may display.**

Cause	Action
The surface of the radar in the radiator grille is dirty or obstructed.	Clean the radiator grille in front of the radar or remove any obstruction.
The surface of the radar is clean but the message remains in the display.	Wait for a short period of time. It may take several minutes for the system to detect that there is no obstruction.
Heavy rain, spray, snow, or fog is interfering with the radar signals.	The system is temporarily disabled. The system should reactivate after a short period of time when the weather conditions improve.
The radar is misaligned.	Have your vehicle checked as soon as possible.

## Driving Aids - Vehicles With: 4.2 Inch Instrument Cluster Display Screen

Cause	Action
The windshield in front of the camera is dirty or obstructed.	Clean the outside of the windshield in front of the camera.
The windshield in front of the camera is clean but the message remains in the display.	Wait for a short period of time. It may take several minutes for the camera to detect that there is no obstruction.
Excessive heat around the camera.	Wait for a short period of time. The message should clear when the temperature around the camera decreases.

### Evasive Steering Assist (If Equipped)

If your vehicle is rapidly approaching a stationary vehicle or a vehicle traveling in the same direction as yours, the system is designed to help you steer around the vehicle.

The system only activates when all of the following occur:

- Active braking and evasive steering assist are switched on in the information display.
- The system detects a vehicle ahead and starts to apply the brakes.
- You significantly turn the steering wheel in an attempt to steer around the vehicle.

After you turn the steering wheel in an attempt to avoid a crash with the vehicle ahead, the system applies additional steering torque to help you steer around the vehicle. After you pass the vehicle, the system applies steering torque when you turn the steering wheel to steer back into the lane. The system deactivates after you fully pass the vehicle.

**Note:** *The system does not automatically steer around a vehicle. If you do not turn the steering wheel, the system does not activate.*

**Note:** *The system does not activate if the distance to the vehicle ahead is too small and a crash cannot be avoided.*

### Switching Evasive Steering Assist On and Off

1. Using the information display controls on the steering wheel, select **Driver assist.**
2. Select **Pre-collision Assist.**
3. Switch **Evasive steering** on or off.

**Note:** *Active braking and evasive steering assist turn on each time you switch the ignition on.*

**Note:** *If you turn active braking off, evasive steering assist also turns off.*

# Driving Aids - Vehicles With: 12.3 Inch Instrument Cluster Display Screen

## INTELLIGENT SPEED LIMITER - VEHICLES WITHOUT: LANE CENTERING

### Principle of Operation



**WARNING:** When you are going downhill, your vehicle speed could increase above the set speed. The system does not apply the brakes.



**WARNING:** You are responsible for controlling your vehicle at all times. The system is designed to be an aid and does not relieve you of your responsibility to drive with due care and attention. Failure to follow this instruction could result in the loss of control of your vehicle, personal injury or death.

The system allows you to limit the vehicle speed to the maximum speed limit detected by the speed sign recognition system. For example, if the speed sign recognition system detects a 80 km/h (50 mph) speed limit, the vehicle speed is limited to 80 km/h (50 mph). You can temporarily exceed the set speed if required, for example to overtake.

**Note:** The system does not limit the vehicle speed to speed limits shown with a supplementary traffic sign in the information display.

### Using Intelligent Speed Limiter

The controls are on the steering wheel.

### Switching Speed Limiter On and Off

**LIM**

Press to switch the system on. The system activates with the detected speed-limit or, if no speed-limit is detected, the current vehicle speed as the set speed. Press again to switch the system off.

### Setting the Speed Limiter

**SET+**

Press the toggle button upward or downward with the system in standby mode to set the speed limiter to the current vehicle speed. The set speed is stored and displayed in the information display.

**SET-**

**Note:** The set speed limiter adjusts when the system detects a different maximum speed limit.

**Note:** If the system cannot detect a maximum speed limit, the system returns to standby mode.

You can adjust the set speed in small or large increments. Press the toggle button upward or downward once to adjust the set speed in small increments. Press and hold the toggle button upward or downward to adjust the set speed in large increments.

### Canceling the Set Speed

**CAN**

Press to cancel the set speed limiter. The system returns to standby mode.

**Note:** The speed limiter icon and the set speed indicator are greyed out in standby mode.

**Note:** The system does not limit the vehicle speed in standby mode.

### Resuming the Set Speed

**RES**

Press to resume the set speed limiter. The system sets the speed limiter to the detected maximum speed limit at the time it resumes.

# Driving Aids - Vehicles With: 12.3 Inch Instrument Cluster Display Screen

## Intentionally Exceeding the Speed Limit

Firmly press the accelerator pedal to temporarily exceed the set speed limit. The system resumes when the vehicle speed drops below the set speed limit, or when you press the **RES** button.

## System Warnings

A warning appears in the information display if any of the following occur:

- The vehicle speed exceeds the current set speed.
- The system detects a maximum speed limit that is lower than the current vehicle speed.
- You intentionally exceed the set speed.
- You unintentionally exceed the set speed, for example when you are going downhill. A tone also sounds.

**Note:** A tone sounds if you continue to exceed the set speed.

**Note:** If the speed sign recognition system detects a speed limit outside the operational speed range, a tone sounds and the system returns to standby mode.

## Adjusting Intelligent Speed Limiter Tolerance Settings

You can set a permanent speed tolerance that is in addition to the detected speed limit.

1. Press the menu button on the steering wheel to enter the information display main menu.
2. Select **Settings**.
3. Select **Driver assistance**.
4. Select **Speed limiter**.
5. Select **Intelligent**.
6. Select **Tolerance**.

7. Select a setting and press the **OK** button.

## Switching From Intelligent Speed Limiter to Speed Limiter

You can change between intelligent speed limiter and normal speed limiter using the information display. Intelligent speed limiter allows you to limit the vehicle speed to the maximum speed limit detected by the speed sign recognition system. Normal speed limiter allows you to manually limit the vehicle speed using controls on the steering wheel.

1. Press the menu button on the steering wheel to enter the information display main menu.
2. Select **Settings**.
3. Select **Driver assistance**.
4. Select **Speed limiter**.
5. Select **Normal** or **Intelligent**.

**Note:** If you switch intelligent speed limiter off, the system defaults to manual speed limiter. You can manually set the speed limiter using the controls on the steering wheel.

## INTELLIGENT SPEED LIMITER - VEHICLES WITH: LANE CENTERING

### Principle of Operation



**WARNING:** When you are going downhill, your vehicle speed could increase above the set speed. The system does not apply the brakes.

# Driving Aids - Vehicles With: 12.3 Inch Instrument Cluster Display Screen



**WARNING:** You are responsible for controlling your vehicle at all times. The system is designed to be an aid and does not relieve you of your responsibility to drive with due care and attention. Failure to follow this instruction could result in the loss of control of your vehicle, personal injury or death.

The system allows you to limit the vehicle speed to the maximum speed limit detected by the speed sign recognition system. For example, if the speed sign recognition system detects a 80 km/h (50 mph) speed limit, the vehicle speed is limited to 80 km/h (50 mph). You can temporarily exceed the set speed if required, for example to overtake.

**Note:** The system does not limit the vehicle speed to speed limits shown with a supplementary traffic sign in the information display.

## Using Intelligent Speed Limiter

The controls are on the steering wheel.

### Switching Speed Limiter On and Off

**LIM**

Press to switch the system on. The system activates with the detected speed-limit or, if no speed-limit is detected, the current vehicle speed as the set speed. Press again with the system in standby mode to switch the system off.

### Setting the Speed Limiter

**SET+**

Press the toggle button upward or downward with the system in standby mode to set the speed limiter to the current vehicle

**SET-**

speed. The set speed is stored and displayed in the information

display.

**Note:** The set speed limiter adjusts when the system detects a different maximum speed limit.

**Note:** If the system cannot detect a maximum speed limit, the system returns to standby mode.

You can adjust the set speed in small or large increments. Press the toggle button upward or downward once to adjust the set speed in small increments. Press and hold the toggle button upward or downward to adjust the set speed in large increments.

### Canceling the Set Speed

**LIM**

Press to cancel the set speed limiter. The system returns to standby mode.

**Note:** The speed limiter icon and the set speed indicator are greyed out in standby mode.

**Note:** The system does not limit the vehicle speed in standby mode.

### Resuming the Set Speed

**RES**

Press to resume the set speed limiter. The system sets the speed limiter to the detected maximum speed limit at the time it resumes.

### Intentionally Exceeding the Speed Limit

Firmly press the accelerator pedal to temporarily exceed the set speed limit. The system resumes when the vehicle speed drops below the set speed limit, or when you press the **RES** button.

# Driving Aids - Vehicles With: 12.3 Inch Instrument Cluster Display Screen

## System Warnings

A warning appears in the information display if any of the following occur:

- The vehicle speed exceeds the current set speed.
- The system detects a maximum speed limit that is lower than the current vehicle speed.
- You intentionally exceed the set speed.
- You unintentionally exceed the set speed, for example when you are going downhill. A tone also sounds.

**Note:** A tone sounds if you continue to exceed the set speed.

**Note:** If the speed sign recognition system detects a speed limit outside the operational speed range, a tone sounds and the system returns to standby mode.

## Adjusting Intelligent Speed Limiter Tolerance Settings

You can set a permanent speed tolerance that is in addition to the detected speed limit.

1. Press the menu button on the steering wheel to enter the information display main menu.
2. Select **Settings**.
3. Select **Driver assistance**.
4. Select **Speed limiter**.
5. Select **Intelligent**.
6. Select **Tolerance**.
7. Select a setting and press the **OK** button.

## Switching From Intelligent Speed Limiter to Speed Limiter

You can change between intelligent speed limiter and normal speed limiter using the information display. Intelligent speed limiter allows you to limit the vehicle speed to the maximum speed limit detected by the speed sign recognition system. Normal speed limiter allows you to manually limit the vehicle speed using controls on the steering wheel.

1. Press the menu button on the steering wheel to enter the information display main menu.
2. Select **Settings**.
3. Select **Driver assistance**.
4. Select **Speed limiter**.
5. Select **Normal** or **Intelligent**.

**Note:** If you switch intelligent speed limiter off, the system defaults to manual speed limiter. You can manually set the speed limiter using the controls on the steering wheel.

## DRIVER ALERT



**WARNING:** You are responsible for controlling your vehicle at all times. The system is designed to be an aid and does not relieve you of your responsibility to drive with due care and attention. Failure to follow this instruction could result in the loss of control of your vehicle, personal injury or death.



**WARNING:** The system may not operate properly if the sensor is blocked. Keep the windshield free from obstruction.

# Driving Aids - Vehicles With: 12.3 Inch Instrument Cluster Display Screen



**WARNING:** Take regular rest breaks if you feel tired. Do not wait for the system to warn you.



**WARNING:** Certain driving styles may result in the system warning you even if you are not feeling tired.



**WARNING:** In cold and severe weather conditions the system may not operate. Rain, snow and spray can all limit sensor performance.



**WARNING:** The system will not operate if the sensor cannot track the road lane markings.



**WARNING:** If damage occurs in the immediate area surrounding the sensor, have your vehicle checked as soon as possible.



**WARNING:** The system may not correctly operate if your vehicle is fitted with a suspension kit not approved by us.

The system is designed to alert you if it calculates that you are becoming drowsy or if your driving deteriorates.

The system calculates your alertness level based upon your driving behavior in relation to the lane markings and other factors when the vehicle speed is greater than approximately 65 km/h (40 mph).

## Driver Alert System Warnings

The warning system has two stages:

1. A temporary warning is issued to advise you to take a rest. This message only appears for a short time.
2. If you do not rest and the system continues to detect that your driving deteriorates, it issues a further warning. This remains in the information display until you cancel it.

**Note:** *The system does not warn you if the vehicle speed falls below approximately 65 km/h (40 mph).*

## Driver Alert Limitations

Your calculated alertness level shows in gray if:

- The sensor cannot track the road lane markings.
- The vehicle speed is less than approximately 65 km/h (40 mph).

## Switching Driver Alert On and Off

1. Press the menu button on the steering wheel to enter the information display main menu.
2. Select **Settings**.
3. Select **Driver assistance**.
4. Switch **Driver alert** on and off.

**Note:** *The system remains on or off depending on how it was last set.*

## Resetting Driver Alert

You can reset the system by:

- Switching the ignition off and on when your vehicle is stationary.
- Opening and closing the driver door when your vehicle is stationary.

# Driving Aids - Vehicles With: 12.3 Inch Instrument Cluster Display Screen

## Driver Alert System Messages

Message	Action
Driver fatigue warning Rest suggested	Displays when we recommend that you take a break due to low alertness levels.
Driver fatigue warning Rest now	Displays when you must take a break due to low alertness levels.

## LANE KEEPING SYSTEM

 **WARNING:** You are responsible for controlling your vehicle at all times. The system is designed to be an aid and does not relieve you of your responsibility to drive with due care and attention. Failure to follow this instruction could result in the loss of control of your vehicle, personal injury or death.

 **WARNING:** The system may not function if the sensor is blocked.

 **WARNING:** The sensor may incorrectly track lane markings as other structures or objects. This can result in a false or missed warning.

 **WARNING:** In cold and severe weather conditions the system may not function. Rain, snow and spray can all limit sensor performance.

 **WARNING:** Large contrasts in outside lighting can limit sensor performance.

 **WARNING:** The system will not operate if the sensor cannot track the road lane markings.

 **WARNING:** If damage occurs in the immediate area surrounding the sensor, have your vehicle checked as soon as possible.

 **WARNING:** The system may not correctly operate if your vehicle is fitted with a suspension kit not approved by us.

The system is designed to alert you by providing temporary steering assistance or steering wheel vibration when it detects an unintended lane departure. The system detects and tracks the road lane markings using a camera mounted behind the interior mirror. The system only operates when the vehicle speed is greater than approximately 65 km/h (40 mph). You can view the system status in the information display.

**Note:** *The system works when the camera can detect at least one lane marking or the edge of the road.*

The system may not correctly operate in any of the following conditions:

- The system does not detect at least one lane marking or the edge of the road.
- You switch the direction indicator on.
- You apply direct steering, accelerate fast or brake hard.
- The vehicle speed is less than 65 km/h (40 mph).



# Driving Aids - Vehicles With: 12.3 Inch Instrument Cluster Display Screen

- The anti-lock brake, stability control or traction control system activates.
- Narrow lane width.

The system may not correct lane positioning in any of the following conditions:

- High winds.
- Uneven road surfaces.
- Heavy or uneven loads.
- Incorrect tire pressure.

## Switching Lane Keeping System On and Off



E270719

Press the button on the direction indicator stalk.

## Lane Keeping System Settings

The system has different settings that you can view or adjust using the information display.

**Note:** *The system remembers the last setting when you start your vehicle. If the system detects a MyKey, the mode is set to alert.*

## Lane Keeping System Display



When you switch the system on, a graphic of lane markings appears in the information display.

The lane markings illuminate green or white if the system is available.

The lane markings illuminate grey if the system is unavailable.

The lane markings do not display if the system is off.

## Alert Mode

Provides steering wheel vibration when the system detects an unintended lane departure. The lane markings in the information display illuminate red.

## Setting the Steering Wheel Vibration Intensity

1. Press the menu button on the steering wheel to enter the information display main menu.
2. Select **Settings**.
3. Select **Driver assistance**.
4. Select **Lane keeping system**.
5. Select **Intensity**.
6. Select a setting and press the **OK** button.

**Note:** *This setting does not affect the aid mode.*

# Driving Aids - Vehicles With: 12.3 Inch Instrument Cluster Display Screen

## Aid Mode

Provides temporary steering assistance toward the lane center when the system detects an unintended lane departure. The lane markings in the information display illuminate amber.

**Note:** When aid mode is on and the system does not detect any steering activity for a short period of time, for example lightly holding the steering wheel, the system alerts you to put your hands on the steering wheel.

**Note:** The aid mode becomes active again after you have returned your vehicle to the center of the lane.

## Alert and Aid Mode

Provides temporary steering assistance toward the lane center when the system detects an unintended lane departure. If your vehicle continues drifting out of the lane, the steering wheel vibrates.

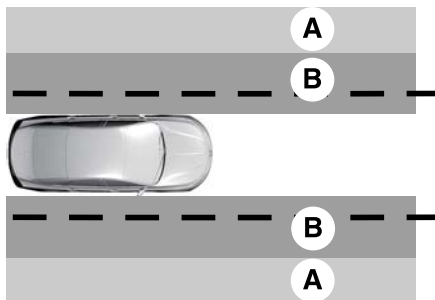

A Alert mode.

B Aid mode.

**Note:** The diagram illustrates general zone coverage. It does not provide exact zone parameters.

## Selecting the Lane Keeping System Modes

1. Press the menu button on the steering wheel to enter the information display main menu.
2. Select **Settings**.
3. Select **Driver assistance**.
4. Select **Lane keeping system**.
5. Select **Mode**.
6. Select a setting and press the **OK** button.

## Lane Keeping System Messages

Message	Action
Lane keeping system malfunction Service required	The system has detected a fault that requires service. Have your vehicle checked as soon as possible.

# Driving Aids - Vehicles With: 12.3 Inch Instrument Cluster Display Screen

## BLIND SPOT INFORMATION SYSTEM



**WARNING:** Do not use the blind spot information system as a replacement for using the interior and exterior mirrors or looking over your shoulder before changing lanes. The blind spot information system is not a replacement for careful driving.



**WARNING:** The system may not operate properly during severe weather conditions, for example snow, ice, heavy rain and spray. Always drive with due care and attention. Failure to take care may result in a crash.

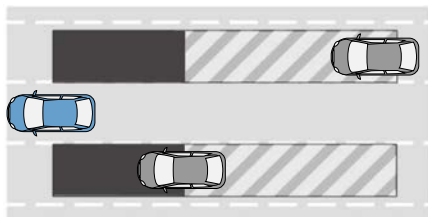

The system is designed to detect vehicles that may have entered the blind spot zone. The detection area is on both sides of your vehicle, extending rearward from the exterior mirrors to approximately 4 m (13 ft) beyond the rear bumper. The detection area extends to approximately 18 m (59 ft) beyond the rear bumper when the vehicle speed is greater than 48 km/h (30 mph) to alert you of faster approaching vehicles.

**Note:** The system does not prevent contact with other vehicles. It is not designed to detect parked vehicles, pedestrians, animals or other infrastructures.

## Using the Blind Spot Information System

### Vehicles with Automatic Transmission

The system turns on when all of the following occur:

- You start your vehicle.
- You shift into drive (D).
- The vehicle speed is greater than 10 km/h (6 mph).

**Note:** The system does not operate in park (P) or reverse (R).

### Vehicles with Manual Transmission

The system turns on when all of the following occur:

- You start your vehicle.
- The vehicle speed is greater than 10 km/h (6 mph).

**Note:** The system does not operate in reverse (R).

## Blind Spot Information System Sensors

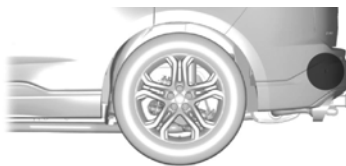

The sensors are behind the rear bumper on both sides of your vehicle.

**Note:** Keep the sensors free from snow, ice and large accumulations of dirt.

## Driving Aids - Vehicles With: 12.3 Inch Instrument Cluster Display Screen

**Note:** Do not cover the sensors with bumper stickers, repair compound or other objects.

**Note:** Blocked sensors could affect system performance.

If the sensors are blocked, a message may appear in the information display. The alert indicators remain illuminated but the system does not alert you.

### Switching the Blind Spot Information System On and Off

1. Press the menu button on the steering wheel to enter the information display main menu.
2. Select **Settings**.
3. Select **Driver assistance**.
4. Switch **BLIS** on or off.

If you switch the system off, a warning lamp illuminates and a message displays. When you switch the system on or off, the alert indicators flash twice.

**Note:** The system remembers the last setting when you start your vehicle.

**Note:** The system may not correctly operate when towing a trailer. For vehicles with a trailer tow module and tow bar approved by us, the system turns off when you attach a trailer. For vehicles with an aftermarket trailer tow module or tow bar, we recommend that you switch the system off when you attach a trailer.

To permanently switch the system off, contact an authorized dealer.

### Blind Spot Information System Indicator



When the system detects a vehicle, an alert indicator illuminates in the exterior mirror on the side the approaching vehicle is coming from. If you turn the direction indicator on for that side of your vehicle, the alert indicator flashes.

If the system detects a fault, an indicator illuminates in the instrument cluster and a message appears in the information display. Have your vehicle checked as soon as possible.

**Note:** The system may not alert you if a vehicle quickly passes through the detection zone.

### Blind Spot Information System Information Messages

Message	Action
BLIS not available Sensor blocked See manual	Displays if the blind spot information system sensors are blocked.
BLIS deactivated Trailer attached	Displays if you attach a trailer to your vehicle.
BLIS malfunction	The system has detected a fault that requires service. Have your vehicle checked as soon as possible.

# Driving Aids - Vehicles With: 12.3 Inch Instrument Cluster Display Screen

## CROSS TRAFFIC ALERT



**WARNING:** Do not use the cross traffic alert system as a replacement for using the interior and exterior mirrors or looking over your shoulder before reversing out of a parking space. The cross traffic alert system is not a replacement for careful driving.



**WARNING:** The system may not operate properly during severe weather conditions, for example snow, ice, heavy rain and spray. Always drive with due care and attention. Failure to take care may result in a crash.

The system is designed to alert you of vehicles approaching from the sides behind your vehicle when you shift into reverse (R). If you continue to reverse after the system alerts you, the system is designed to apply the brakes if it still detects an approaching vehicle. If the system applies the brakes, a message appears in the information display.

**Note:** *The system does not apply the brakes if you override it by firmly pressing the accelerator pedal.*

### Using Cross Traffic Alert

The system is designed to detect vehicles that approach at a speed between 6 km/h (4 mph) and 60 km/h (37 mph). Coverage decreases when the sensors are partially, mostly or fully obstructed. Slowly reversing helps increase the coverage area and effectiveness.

The system turns on when you start the engine and you shift into reverse (R). The system turns off when you shift out of reverse (R).

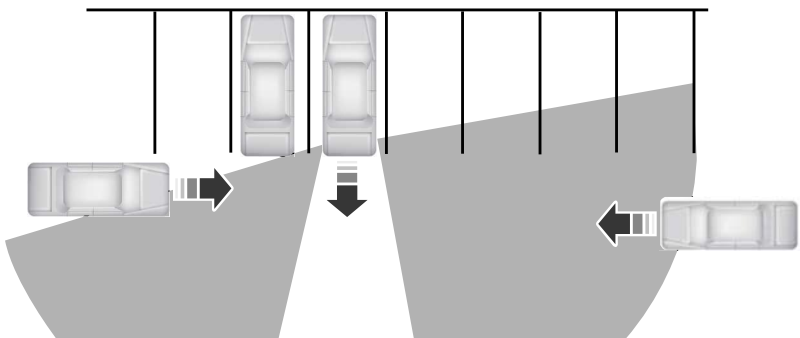

## Driving Aids - Vehicles With: 12.3 Inch Instrument Cluster Display Screen

The sensor on the left-hand side is only partially obstructed and zone coverage on

the right-hand side is maximized.

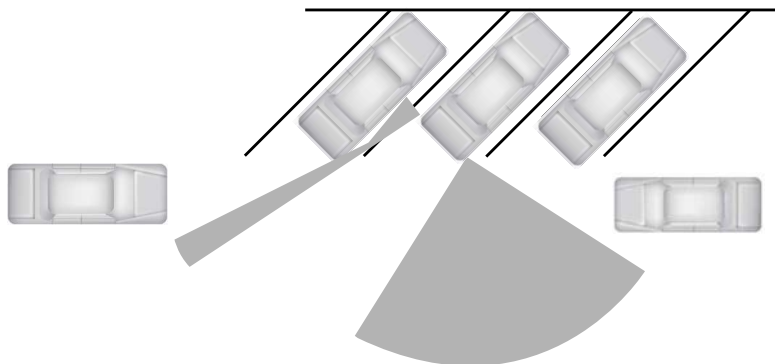

Zone coverage also decreases when parking at narrow angles. The sensor on the left-hand side is mostly obstructed and zone coverage on that side is severely reduced.

### Cross Traffic Alert System Sensors



The sensors are behind the rear bumper on both sides of your vehicle.

**Note:** Keep the sensors free from snow, ice and large accumulations of dirt.

**Note:** Do not cover the sensors with bumper stickers, repair compound or other objects.

**Note:** Blocked sensors could affect system performance.

If the sensors are blocked, a message may appear in the information display when you shift into reverse (R).

### Cross Traffic Alert System Limitations

The system may not correctly operate when any of the following occur:

- The sensors are blocked.
- Adjacently parked vehicles or objects are obstructing the sensors.
- Vehicles approach at speeds less than 6 km/h (4 mph) or greater than 60 km/h (37 mph).
- The vehicle speed is greater than 12 km/h (7 mph).
- You reverse out of an angled parking space.

# Driving Aids - Vehicles With: 12.3 Inch Instrument Cluster Display Screen

## Switching Cross Traffic Alert On and Off

1. Press the menu button on the steering wheel to enter the information display main menu.
2. Select **Settings**.
3. Select **Driver assistance**.
4. Switch **Cross traffic alert** on and off.

**Note:** If you temporarily switch the system off, it turns on the next time you switch the ignition on.

**Note:** The system may not correctly operate when towing a trailer. For vehicles with a trailer tow module and tow bar approved by us, the system turns off when you attach a trailer. For vehicles with an aftermarket trailer tow module or tow bar, we recommend that you switch the system off when you attach a trailer.

To permanently switch the system off, contact an authorized dealer.

## Cross Traffic Alert Indicator



When the system detects an approaching vehicle a tone sounds, an indicator illuminates in the relevant exterior mirror and arrows appear in the information display to show which side the approaching vehicle is coming from.

**Note:** If arrows do not display, a message appears in the information display.

If the system malfunctions, an indicator illuminates in the instrument cluster and a message appears in the information display. Have your vehicle checked as soon as possible.

**Note:** In exceptional conditions, the system could alert you or apply the brakes, even when there is nothing in the detection zone, for example a vehicle passing further away from your vehicle.

## Cross Traffic Alert Information Messages

Message	Action
Cross traffic alert	Displays instead of indication arrows when the system detects a vehicle. Check for approaching traffic.
Cross traffic not available Sensor blocked See manual	Displays if the cross traffic alert system sensors are blocked. Clean the sensors. If the message continues to appear, have your vehicle checked as soon as possible.
Cross traffic malfunction	The system has malfunctioned. Have your vehicle checked as soon as possible.
Cross traffic alert deactivated Trailer attached	Displays if you attach a trailer to your vehicle.
Cross traffic alert Applying brakes	Displays if the system applies the brakes. Check for approaching traffic.

# Driving Aids - Vehicles With: 12.3 Inch Instrument Cluster Display Screen

## TRAFFIC SIGN RECOGNITION

### Principle of Operation



**WARNING:** You are responsible for controlling your vehicle at all times. The system is designed to be an aid and does not relieve you of your responsibility to drive with due care and attention. Failure to follow this instruction could result in the loss of control of your vehicle, personal injury or death.



**WARNING:** The system may not operate properly if the sensor is blocked. Keep the windshield free from obstruction.

The system is designed to detect traffic signs to inform you of the current speed limit and overtaking regulations. Detected traffic signs appear in the information display. The sensor is behind the interior mirror.

**Note:** Do not carry out windshield repairs in the immediate area surrounding the sensor.

**Note:** Traffic sign data provided by the navigation system contains information integrated to the data carrier release.

The system detects recognizable traffic signs, for example:

- Speed limit signs.
- No overtaking signs.
- Speed limit cancellation signs.
- No overtaking cancellation signs.

**Note:** The system may not detect all traffic signs and may incorrectly read signs.

**Note:** In cold and severe weather conditions the system may not function. Rain, snow, spray and large contrasts in lighting can all prevent the sensor from correctly functioning.

**Note:** If your vehicle has a suspension kit not approved by us, the system may not correctly function.

**Note:** Always fit Ford original parts when replacing headlamp bulbs. Other bulbs may reduce system performance.

The system turns on when you switch the ignition on and you cannot switch the system off.

### Switching Speed Warning On and Off

1. Press the menu button on the steering wheel to enter the information display main menu.
2. Select **Settings**.
3. Select **Driver assistance**.
4. Select **Traffic signs**.
5. Switch **Speed warning** on or off.

### Setting the Speed Warning

You can set the system speed warning to alert you when the vehicle speed exceeds the speed limit recognized by the system by a certain speed tolerance.

1. Press the menu button on the steering wheel to enter the information display main menu.
2. Select **Settings**.
3. Select **Driver assistance**.
4. Select **Traffic signs**.
5. Select **Speed warning**.
6. Select a setting and press the **OK** button.



# Driving Aids - Vehicles With: 12.3 Inch Instrument Cluster Display Screen

## Traffic Sign Recognition System Display



The system can display two traffic signs in parallel.

You can view the status at any time using the information display.

The system displays recognizable traffic signs in four stages as follows:

1. All new traffic signs appear brighter than the others in the display.
2. After a predetermined time they display normally.
3. After a predetermined distance they are greyed out.
4. After another predetermined distance they are deleted.

If the system detects a supplementary traffic sign, it displays below the respective traffic sign. For example, when passing a reduced speed limit in wet road conditions sign.

**Note:** *If your vehicle has a navigation system, stored traffic sign data may influence the indicated speed limit value.*

## Traffic Sign Recognition System Messages

Message	Action
Traffic sign recognition Reduced performance See manual	The traffic sign data provided by the navigation system is unavailable due to weak or no signal. Wait for a short period of time for the signal to improve. If the message continues to appear, have your vehicle checked as soon as possible.

## SPEED SIGN RECOGNITION

### Principle of Operation



**WARNING:** You are responsible for controlling your vehicle at all times. The system is designed to be an aid and does not relieve you of your responsibility to drive with due care and attention. Failure to follow this instruction could result in the loss of control of your vehicle, personal injury or death.



**WARNING:** The system may not operate properly if the sensor is blocked. Keep the windshield free from obstruction.

The system is designed to detect speed limit signs to inform you of the current speed limit. Detected speed signs appear in the information display. The sensor is behind the interior mirror.

**Note:** *Do not carry out windshield repairs in the immediate area surrounding the sensor.*

## Driving Aids - Vehicles With: 12.3 Inch Instrument Cluster Display Screen

**Note:** Speed sign data provided by the navigation system contains information integrated to the data carrier release.

**Note:** The system may not detect all speed signs and may incorrectly read signs.

**Note:** In cold and severe weather conditions the system may not function. Rain, snow, spray and large contrasts in lighting can all prevent the sensor from correctly functioning.

**Note:** If your vehicle has a suspension kit not approved by us, the system may not correctly function.

**Note:** Always fit Ford original parts when replacing headlamp bulbs. Other bulbs may reduce system performance.

The system turns on when you switch the ignition on and you cannot switch the system off.

### Using Speed Sign Recognition

#### Switching Speed Warning On and Off

1. Press the menu button on the steering wheel to enter the information display main menu.
2. Select **Settings**.
3. Select **Driver assistance**.
4. Select **Traffic signs**.
5. Switch **Speed warning** on and off.

#### Setting the Speed Warning

You can set the system speed warning to alert you when the vehicle speed exceeds the speed limit recognized by the system by a certain speed tolerance.

1. Press the menu button on the steering wheel to enter the information display main menu.
2. Select **Settings**.
3. Select **Driver assistance**.
4. Select **Traffic signs**.

5. Select **Speed warning**.
6. Select a setting and press the **OK** button.

### Speed Sign Recognition System Display

When the system detects a speed limit sign, the speed limit appears in the information display.

**Note:** If your vehicle has a navigation system, stored speed sign data could influence the indicated speed limit value.

### WRONG WAY ALERT



**WARNING:** You are responsible for controlling your vehicle at all times. The system is designed to be an aid and does not relieve you of your responsibility to drive with due care and attention. Failure to follow this instruction could result in the loss of control of your vehicle, personal injury or death.



**WARNING:** The system may not operate properly if the sensor is blocked. Keep the windshield free from obstruction.

The system is designed to alert you if it detects that you are driving the wrong way on a freeway exit road. The system uses a sensor behind the interior mirror to detect no entry signs and uses information from the navigation system.

**Note:** Do not carry out windshield repairs in the immediate area surrounding the sensor.

**Note:** Traffic sign data provided by the navigation system contains information integrated to the data carrier release.

**Note:** The system is designed to detect traffic signs meeting the Vienna convention.

# Driving Aids - Vehicles With: 12.3 Inch Instrument Cluster Display Screen

**Note:** The system may not detect all traffic signs and may incorrectly read signs.

**Note:** If your vehicle has a suspension kit not approved by us, the system may not correctly function.

**Note:** Always fit Ford original parts when replacing headlamp bulbs. Other bulbs may reduce system performance.

**Note:** The system does not operate in some countries. We recommend that you check system availability before use.

If the system detects that you are driving the wrong way on a freeway exit road, a message appears in the information display and a tone sounds. The audio system volume mutes and navigation system guidance pauses.

**Note:** In cold and severe weather conditions the system may not function. Rain, snow, spray and large contrasts in lighting can all prevent the sensor from functioning correctly.

**Note:** The system may not correctly operate in areas under construction or new infrastructure.

**Note:** In exceptional conditions, the system could alert you even if you are not driving the wrong way on a freeway exit road.

## Switching Wrong Way Alert On and Off

1. Press the menu button on the steering wheel to enter the information display main menu.
2. Select **Settings**.
3. Select **Driver assistance**.
4. Switch **Wrong way alert** on and off.

**Note:** The system remembers the last setting when you start your vehicle.

## Wrong Way Alert Information Messages

Message	Action
Check driving direction	The system has detected that you are driving the wrong way on a freeway exit road. Press the <b>OK</b> button.

## ECO

### Principle of Operation

The system is designed to monitor certain driving characteristics to help you drive more efficiently. See **Driving Economically** (page 388).

**Note:** The efficiency levels do not result in a defined fuel consumption figure. See **Fuel Consumption** (page 221).

**Note:** The system only indicates the efficiency level for the current trip. The system resets each time you switch the ignition on.

### Eco Mode System Display

You can view the instantaneous efficiency level or the trip summary in the information display.

1. Press the menu button on the steering wheel to enter the information display main menu.
2. Select **Display settings**.
3. Select **Eco coach**.

## Driving Aids - Vehicles With: 12.3 Inch Instrument Cluster Display Screen

4. Select a setting and press the **OK** button.

### Instantaneous Efficiency Level

The display circle illuminates as the instantaneous efficiency level increases. The level continuously updates to indicate the efficiency level for the current trip.

### Trip Summary

You can check the trip summary status for acceleration, deceleration and speed during the total distance traveled by your vehicle for the current trip in the information display.

### Checking Trip Summary Status

1. Press the menu button on the steering wheel to enter the information display main menu.
2. Select **Select screens**.
3. Select **Eco behaviour**.
4. Select the screen on your main screen. See **General Information** (page 153).

## PRE-COLLISION ASSIST

 **WARNING:** You are responsible for controlling your vehicle at all times. The system is designed to be an aid and does not relieve you of your responsibility to drive with due care and attention. Failure to follow this instruction could result in the loss of control of your vehicle, personal injury or death.

 **WARNING:** The system does not operate during hard acceleration or steering. Failure to take care may lead to a crash or personal injury.

 **WARNING:** The system may fail or operate with reduced function during cold and severe weather conditions. Snow, ice, rain, spray and fog can adversely affect the system. Keep the front camera and radar free of snow and ice. Failure to take care may result in the loss of control of your vehicle, serious personal injury or death.

 **WARNING:** The system may not operate properly if your vehicle has a non-Ford windshield. Do not carry out windshield repairs in the area around the sensor.

 **WARNING:** System performance could be reduced in situations where the vehicle camera has limited detection capability. These situations include but are not limited to direct or low sunlight, vehicles at night without tail lights, unconventional vehicle types, pedestrians or cyclists with complex backgrounds, running pedestrians or fast moving cyclists, partly obscured pedestrians or cyclists, pedestrians or cyclists that the system cannot distinguish from a group. Failure to take care may result in the loss of control of your vehicle, personal injury or death.

 **WARNING:** The Pre-Collision Assist system with brake support cannot help prevent all collisions. Do not rely on this system to replace your judgment and the need to maintain correct distance and speed.

The pre-collision assist system is active when your vehicle reaches a speed greater than approximately 5 km/h (3 mph). Pedestrian and cyclist detection is active at speeds up to 80 km/h (50 mph).

**Note:** *The system is not designed to detect animals.*

# Driving Aids - Vehicles With: 12.3 Inch Instrument Cluster Display Screen

**Note:** *The system is not designed to detect vehicles that are traveling in a different direction.*



E156130

If your vehicle is rapidly approaching another stationary vehicle, a vehicle traveling in the same direction as yours, a pedestrian or a cyclist within your driving path, the system is designed to provide three levels of functionality.

Level of Functionality	Description
Alert	When activated, a warning lamp flashes and an audible warning sounds.
Brake support	The system is designed to help reduce the impact speed by preparing the brakes for rapid braking. The system does not automatically apply the brakes. If you press the brake pedal, the system could apply additional braking up to maximum braking force, even if you lightly press the brake pedal.
Active braking - vehicles without adaptive cruise control	The system is designed to apply the brakes if it detects a crash is imminent. This may help reduce impact or avoid the crash. The system is active at speeds up to 130 km/h (80 mph).
Active braking - vehicles with adaptive cruise control	The system is designed to apply the brakes if it detects a crash is imminent. This may help reduce impact or avoid the crash.

## Switching Active Braking On and Off

1. Press the menu button on the steering wheel to enter the information display main menu.
2. Select **Settings**.
3. Select **Driver assistance**.
4. Select **Pre-collision assist**.
5. Switch **Active braking** on or off.

## Distance Alert (If Equipped)

A warning lamp illuminates if the distance to the vehicle ahead is small.

**Note:** *The warning lamp does not illuminate if cruise control or adaptive cruise control is active.*

## Setting the Distance Alert Sensitivity

1. Press the menu button on the steering wheel to enter the information display main menu.
2. Select **Settings**.
3. Select **Driver assistance**.
4. Select **Pre-collision assist**.
5. Select **Alert sensitivity**.
6. Select a setting and press the **OK** button.

## Distance Indication (If Equipped)

A graphical indication displays the time gap to vehicles ahead of you traveling in the same direction.

# Driving Aids - Vehicles With: 12.3 Inch Instrument Cluster Display Screen

**Note:** The graphic does not display if you switch on cruise control or adaptive cruise control.

Vehicle Speed	System Sensitivity	Distance Indicator Color	Distance Gap	Time Gap
100 km/h (62 mph)	Normal.	Gray.	Greater than 25 m (82.0 ft).	Greater than 0.9 seconds.
		Yellow.	17–25 m (55.8–82.0 ft).	0.6–0.9 seconds.
		Red.	Less than 17 m (55.8 ft).	Less than 0.6 seconds.

## Switching Distance Indication On and Off

1. Press the menu button on the steering wheel to enter the information display main menu.
2. Select **Settings**.
3. Select **Driver assistance**.
4. Select **Pre-collision assist**.
5. Switch **Distance indication** on or off.

## Pre-Collision Assist System Sensors

### Vehicles without Adaptive Cruise Control



E243054

The camera is mounted behind the interior mirror.

**Note:** Keep the sensors free from snow, ice and large accumulations of dirt.

**Note:** Do not clean the sensors with sharp objects.

**Note:** If your vehicle sustains damage leaving the sensors misaligned, this may cause inaccurate measurements or false alerts.

Blocked sensors could affect system accuracy. A message may appear in the information display.

### Vehicles with Adaptive Cruise Control

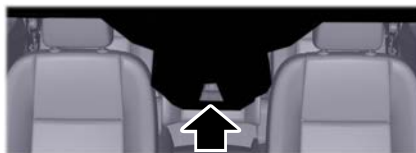

E243054

The camera is mounted behind the interior mirror.

# Driving Aids - Vehicles With: 12.3 Inch Instrument Cluster Display Screen



E244279

The radar sensor is behind the front grille below the license plate.

**Note:** Keep the sensors free from snow, ice and large accumulations of dirt.

**Note:** Do not clean the sensors with sharp objects.

**Note:** If your vehicle sustains damage leaving the sensors misaligned, this may cause inaccurate measurements or false alerts.

Blocked sensors could affect system accuracy. A message may appear in the information display.

## Pre-Collision Assist Warning Lamp



It illuminates if your vehicle rapidly approaches another vehicle, to warn you of the risk of a crash with the vehicle in front of you.

It could illuminate red if the distance to the vehicle ahead is small.

It illuminates when the system is not available.

## Pre-Collision Assist Information Messages

Message	Action
Pre-collision assist not available	The system has malfunctioned. Have your vehicle checked as soon as possible.
Pre-collision assist not available Sensor blocked	The sensors are dirty. Clean the sensors. If the message continues to appear, have your vehicle checked as soon as possible.

The following table lists possible causes and actions for when a blocked sensor message may display.

Cause	Action
The surface of the radar in the radiator grille is dirty or obstructed.	Clean the radiator grille in front of the radar or remove any obstruction.
The surface of the radar is clean but the message remains in the display.	Wait for a short period of time. It may take several minutes for the system to detect that there is no obstruction.
Heavy rain, spray, snow, or fog is interfering with the radar signals.	The system is temporarily disabled. The system should reactivate after a short period of time when the weather conditions improve.

## Driving Aids - Vehicles With: 12.3 Inch Instrument Cluster Display Screen

Cause	Action
The radar is misaligned.	Have your vehicle checked as soon as possible.
The windshield in front of the camera is dirty or obstructed.	Clean the outside of the windshield in front of the camera.
The windshield in front of the camera is clean but the message remains in the display.	Wait for a short period of time. It may take several minutes for the camera to detect that there is no obstruction.
Excessive heat around the camera.	Wait for a short period of time. The message should clear when the temperature around the camera decreases.

### Evasive Steering Assist (If Equipped)

If your vehicle is rapidly approaching a stationary vehicle or a vehicle traveling in the same direction as yours, the system is designed to help you steer around the vehicle.

The system only activates when all of the following occur:

- Active braking and evasive steering assist are switched on in the information display.
- The system detects a vehicle ahead and starts to apply the brakes.
- You significantly turn the steering wheel in an attempt to steer around the vehicle.

After you turn the steering wheel in an attempt to avoid a crash with the vehicle ahead, the system applies additional steering torque to help you steer around the vehicle. After you pass the vehicle, the system applies steering torque when you turn the steering wheel to steer back into the lane. The system deactivates after you fully pass the vehicle.

**Note:** *The system does not automatically steer around a vehicle. If you do not turn the steering wheel, the system does not activate.*

**Note:** *The system does not activate if the distance to the vehicle ahead is too small and a crash cannot be avoided.*

### Switching Evasive Steering Assist On and Off

1. Press the menu button on the steering wheel to enter the information display main menu.
2. Select **Settings**.
3. Select **Driver assistance**.
4. Select **Pre-collision assist**.
5. Switch **Evasive steering** on or off.

**Note:** *Active braking and evasive steering assist turn on each time you switch the ignition on.*

**Note:** *If you turn active braking off, evasive steering assist also turns off.*



# Drive Mode Control

## WHAT IS DRIVE MODE CONTROL

Your vehicle has various drive modes that you can select for different driving conditions. Depending on the drive mode that you select, the system adjusts various vehicle settings, for example steering, gear shifting, handling and powertrain response.

## SELECTING A DRIVE MODE - EXCLUDING: ST

The button is on the center console.



Repeatedly press the button to scroll through the available drive modes.

## SELECTING A DRIVE MODE - ST

The buttons are on the steering wheel.



Repeatedly press the button to scroll through the available drive modes. Release the button to confirm your selected drive mode.



Press the button to directly turn sport mode on and off.

## DRIVE MODES

### Comfort - Excluding: ST



Vehicle settings suited for comfortable driving.

### Eco - Excluding: ST



Vehicle settings suited for economical driving.

### Eco Comfort - Excluding: ST



Vehicle settings suited for comfortable and economical driving.

### Normal



Vehicle settings suited for balanced driving.

**Note:** *This is the default mode each time you switch the ignition on.*

### Slippery



Vehicle settings suited for driving on slippery roads.

### Sport - Excluding: ST



Vehicle settings suited for sportier driving.

**Note:** *Auto-start-stop switches off when you select this mode.*

### Sport - ST, Manual Transmission



Vehicle settings suited for sportier driving.

**Note:** *Press the button on the steering wheel to directly select this mode.*

**Note:** *Auto-start-stop switches off when you select this mode.*

### Sport - ST, Automatic Transmission



Vehicle settings suited for sportier driving.

**Note:** *Press the button on the steering wheel to directly select this mode.*

# Drive Mode Control

**Note:** Auto-start-stop switches off when you select this mode.

**Note:** The seventh gear is disabled when you select this mode.

## Track - ST, Manual Transmission



Vehicle settings suited for track driving.

**Note:** Auto-start-stop switches off when you select this mode.

**Note:** Pre-collision assist is disabled when you select this mode.

**Note:** Lane keeping system is disabled when you select this mode.

**Note:** Track mode is not intended for use on public roads.

**Note:** Stability control is switched to reduced mode when you select this mode.

## Track - ST, Automatic Transmission



Vehicle settings suited for track driving.

**Note:** Auto-start-stop switches off when you select this mode.

**Note:** Pre-collision assist is disabled when you select this mode.

**Note:** Lane keeping system is disabled when you select this mode.

**Note:** Track mode is not intended for use on public roads.

**Note:** Stability control is switched to reduced mode when you select this mode.

**Note:** The seventh gear is disabled when you select this mode.

## Trail - Excluding: ST



Vehicle settings suited for driving on unpaved roads.

**Note:** Auto-start-stop is disabled when you select this mode.

## DRIVE MODE CONTROL – TROUBLESHOOTING

### Drive Mode Control – Information Messages

Message	Description
Drive mode not available	The system is not available. If it is still not available the next time you switch the ignition on, the system has malfunctioned. Have your vehicle checked as soon as possible.

# Efficient Drive Mode

---

## WHAT IS EFFICIENT DRIVE MODE

Efficient drive mode is a predictive coach that uses the vehicle navigation data. It provides predictive route information to help you drive more efficiently by indicating when you can release the accelerator pedal.

## SWITCHING EFFICIENT DRIVE MODE ON AND OFF - VEHICLES WITH: 4.2 INCH INSTRUMENT CLUSTER DISPLAY SCREEN

1. Using the information display controls on the steering wheel, select **Driver assist.**
2. Select **Eco coach.**
3. Switch **Eco advice** on or off.

## SWITCHING EFFICIENT DRIVE MODE ON AND OFF - VEHICLES WITH: 12.3 INCH INSTRUMENT CLUSTER DISPLAY SCREEN

1. Press the menu button on the steering wheel to enter the information display main menu.
2. Select **Display settings.**
3. Select **Eco coach.**
4. Switch **Eco advice** on or off.

## DISPLAYING THE EFFICIENT DRIVE MODE - VEHICLES WITH: 4.2 INCH INSTRUMENT CLUSTER DISPLAY SCREEN

1. Using the information display controls on the steering wheel, select **Driver assist.**

## TRIP SUMMARY

### How Does Trip Summary Work

The calculated trip summary is shown as five colored bars. The bars travel from left to right as the calculated efficiency levels increase. The bars indicate the average efficiency level for your driving behavior, acceleration, deceleration, speed, gear shifting and compliance score during the total distance traveled by your vehicle for the current trip.

**Note:** *The compliance score assesses how well you follow the efficient drive mode indicator.*

**Note:** *Vehicles with an automatic transmission do not have a bar for gear shifting.*

### Viewing the Trip Summary - Vehicles With: 4.2 Inch Instrument Cluster Display Screen

1. Using the information display controls on the steering wheel, select **MyView.**
2. Select **Eco coach.**
3. Switch the engine off.
4. Press the **OK** button.

# Efficient Drive Mode

---

## Viewing the Trip Summary - Vehicles With: 12.3 Inch Instrument Cluster Display Screen



Repeatedly press the button to scroll through the available drive modes.

The button is on the center console.

1. Select **ECO**.
2. Press the menu button on the steering wheel to enter the information display main menu.
3. Select **Display settings**.
4. Select **Eco coach**.
5. Switch **Eco advice** on.
6. Switch the engine off.

## EFFICIENT DRIVE MODE INDICATORS



It illuminates grey when the system recommends you to decelerate.

It changes color when you start to decelerate.

The additional display ring next to the efficient drive mode indicator can provide information about speed limit, intersection, freeway ramp, roundabout, stop sign, slope, curve or crosswalk.

# Local Hazard Information

---

## WHAT IS LOCAL HAZARD INFORMATION

The system is designed to provide near real-time information about the road in front of you.

## LOCAL HAZARD INFORMATION PRECAUTIONS



**WARNING:** You are responsible for controlling your vehicle at all times. The system is designed to be an aid and does not relieve you of your responsibility to drive with due care and attention. Failure to follow this instruction could result in the loss of control of your vehicle, personal injury or death.

## ENABLING LOCAL HAZARD INFORMATION

**Note:** Make sure that the modem is enabled. See **Enabling and Disabling the Modem** (page 497).

1. Select **Settings**.
2. Select **FordPass Connect**.
3. Select **Connectivity settings**.
4. Switch **Vehicle connectivity** on.
5. Switch **Location** on.
6. Switch **Vehicle data & Remote ctrl** on.
7. Switch **Live Traffic** on.
8. Switch **Local hazard information** on.

## CHECKING LOCAL HAZARD INFORMATION STATUS - VEHICLES WITH: 4.2 INCH INSTRUMENT CLUSTER DISPLAY SCREEN

1. Using the information display controls on the steering wheel, select **Settings**.
2. Select **Information**.
3. Select **Local hazard information**.

## CHECKING LOCAL HAZARD INFORMATION STATUS - VEHICLES WITH: 12.3 INCH INSTRUMENT CLUSTER DISPLAY SCREEN

1. Press the menu button on the steering wheel to enter the information display main menu.
2. Select **Settings**.
3. Select **Local hazard information**.

# Load Carrying

## GENERAL INFORMATION

**WARNING:** Make sure that you properly secure objects in the luggage compartment. Failure to follow this instruction could result in personal injury in the event of a sudden stop or crash.

**WARNING:** Do not place objects on the luggage cover. Failure to follow this instruction could result in personal injury or death in the event of a sudden stop or crash.

**WARNING:** The appropriate loading capacity of your vehicle can be limited either by volume capacity (how much space is available) or by payload capacity (how much weight the vehicle should carry). Once you have reached the maximum payload of your vehicle, do not add more cargo, even if there is space available. Overloading or improperly loading your vehicle can contribute to loss of vehicle control and vehicle rollover.

**WARNING:** Make sure that you fully close the liftgate to prevent exhaust fumes from entering your vehicle. If you are unable to fully close the liftgate, open the air vents or the windows to allow fresh air to enter your vehicle. Failure to follow this instruction could result in personal injury or death.

**WARNING:** Do not exceed the maximum front and rear axle loads for your vehicle.

**Note:** When loading long objects into your vehicle, for example pipes, timber or furniture be careful not to damage the interior trim.

## LUGGAGE ANCHOR POINTS

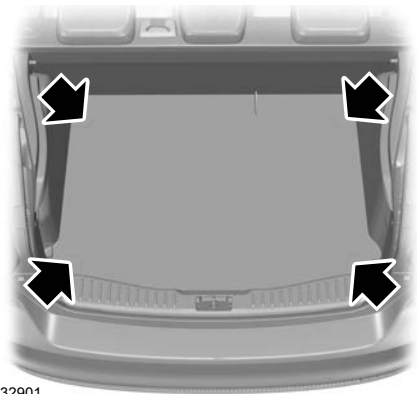

E132901

## REAR LOADSPACE HATCHES

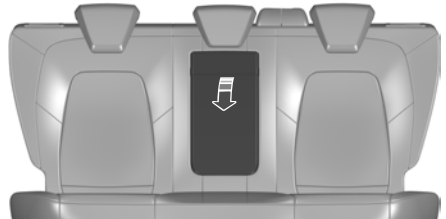

E267028

# Load Carrying

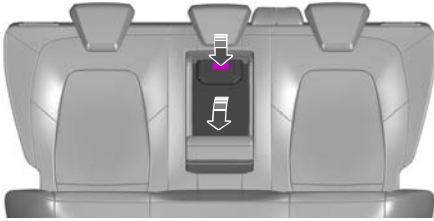

E267029

**Note:** Do not exceed a load of 35 kg (77 lb).

**Note:** If necessary, raise the center head restraint.

## REAR UNDER FLOOR STORAGE - WAGON

Space is available below the loadspace floor to stow items.

### Flat Load Space Floor

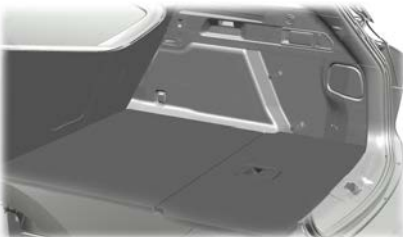

E269201

## Tonneau Cover Storage

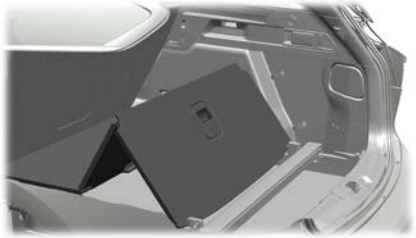

E269202

See **Luggage Covers** (page 373).

## Rear Section Under Floor Storage

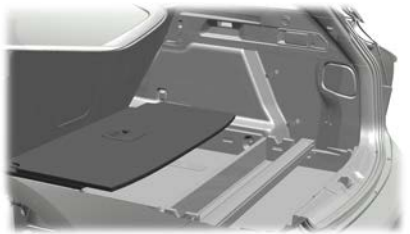

E269203

## Front Section Under Floor Storage

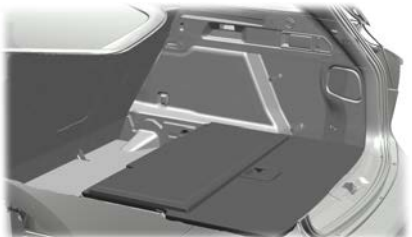

E269204

# Load Carrying

## Increasing the Loadspace Height

You can fold or remove the loadspace floor to increase the available loadspace height.

**Note:** We recommend you fold the loadspace floor before you remove it.

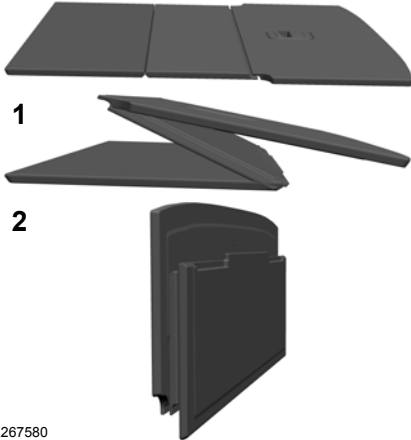

E267580

1. Fold the center section of the loadspace floor toward the front of your vehicle.
2. Fold the loadspace floor upward toward the front of your vehicle.



E267494

3. Remove any additional loadspace floor supports.

4. To install, reverse the removal procedure.

## CARGO NETS - WAGON

### Luggage Retention Net

Luggage retention net anchor points are fitted behind the second row seats.

To install the luggage retention net cassette:

1. Remove the luggage cover.
2. Push the sliders on the cassette toward each other and insert the telescopic bar into the holes on the sidewall behind the rear seat backrests.

**Note:** Make sure that the end caps with the anti-rotation pin are correctly fitted in the side trim.

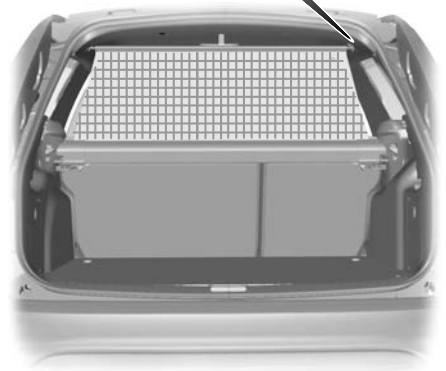
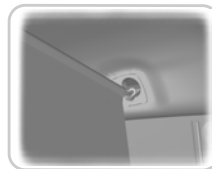

E78834



# Load Carrying

3. Pull up the net and insert the ends of the bar into the retainers on the roof.

**Note:** Make sure that the bar is pushed forward into the narrow section of the retainers.

4. Reinstall the luggage cover.

## LUGGAGE COVERS - WAGON

### Opening the Luggage Cover



**WARNING:** Do not place objects on the luggage cover. Failure to follow this instruction could result in personal injury or death in the event of a sudden stop or crash.



E267491

1. Fully pull the luggage cover out.

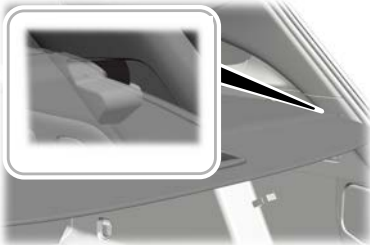

E267490

2. Securely place the retaining pins in the trim panels on both sides.

### Closing the Luggage Cover

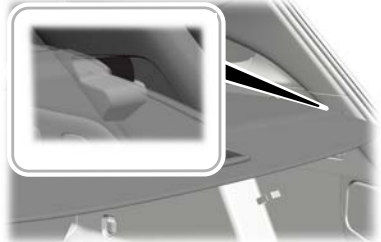

E267490

1. Slightly pull the luggage cover backward to release the retaining pins from the trim panels on both sides.
2. Slowly roll the luggage cover into the casing.

### Removing the Luggage Cover

1. Fully close the luggage cover.

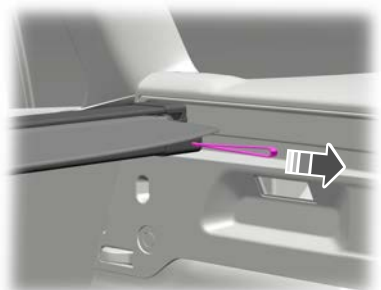

E267492

2. Pull the strap toward the rear of your vehicle.

**Note:** Support the center of the luggage cover when you pull the strap.

# Load Carrying

## Stowing the Luggage Cover

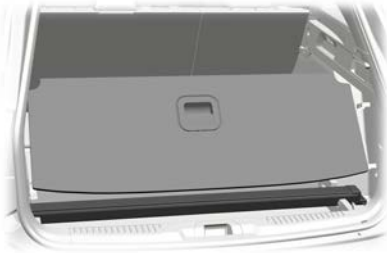

E267493

The luggage cover can be stowed under the loadspace floor.

## LUGGAGE COVERS - 5-DOOR

**WARNING:** Do not load any objects on the shelf that may obstruct your vision or strike occupants of the vehicle in the case of a sudden stop or collision.

## Removing the Cover

To remove the luggage cover:

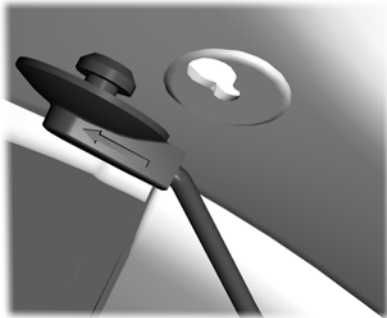

E266421

1. Gently push the retaining clip up and remove it.
2. Raise the luggage cover.
3. Pull the luggage cover backward.

## ROOF RACKS AND LOAD CARRIERS - 4-DOOR, VEHICLES WITH: PANORAMIC ROOF OPENING PANEL

**WARNING:** Your vehicle is not approved for roof racks. Never install a roof rack to your vehicle.

## ROOF RACKS AND LOAD CARRIERS - 5-DOOR, VEHICLES WITH: PANORAMIC ROOF OPENING PANEL

**WARNING:** Read and follow the manufacturer's instructions when you are fitting a roof rack.

**WARNING:** When loading the roof racks, we recommend you evenly distribute the load, as well as maintain a low center of gravity. Loaded vehicles, with higher centers of gravity, may handle differently than unloaded vehicles. Take extra precautions, such as slower speeds and increased stopping distance, when driving a heavily loaded vehicle.

The maximum recommended load, evenly distributed on the roof rack is 75 kg (165 lb).

If the vehicle has moonroof, make sure it is closed before fitting the cross bars and remains closed.

# Load Carrying

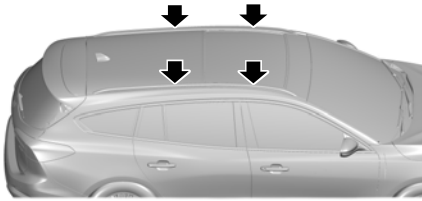

E282695

Fix the cross bars on the rail markings.

Make sure that you securely fasten the load. Check the tightness of the load before driving and at each fuel stop.

**Note:** *Never place loads directly on the roof panel.*

## Towbar Carriers

When using a towbar attached carrier, consider the following:

- Do not exceed the maximum vertical weight on the towball. This is the weight of the carrier plus the weight of the load. See **Towbar Dimensions** (page 472).
- Pay attention to the carrier manufacturer's specifications.
- If you are using a bike carrier, the maximum number of allowed bikes is three, with a maximum allowed weight of 130 lb (60 kg).
- Load the heaviest item closest to your vehicle.

## ROOF RACKS AND LOAD CARRIERS - WAGON, VEHICLES WITH: PANORAMIC ROOF OPENING PANEL

 **WARNING:** Read and follow the manufacturer's instructions when you are fitting a roof rack.

 **WARNING:** When loading the roof racks, we recommend you evenly distribute the load, as well as maintain a low center of gravity. Loaded vehicles, with higher centers of gravity, may handle differently than unloaded vehicles. Take extra precautions, such as slower speeds and increased stopping distance, when driving a heavily loaded vehicle.

The maximum recommended load, evenly distributed on the roof rack is 75 kg (165 lb).

Make sure the moonroof is closed before fitting the cross bars and it remains closed.

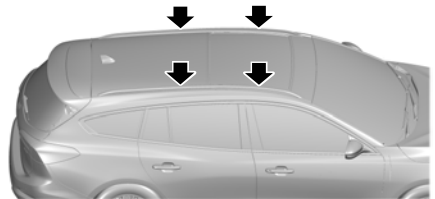

E282695

Fix the cross bars on the rail markings.

Make sure that you securely fasten the load. Check the tightness of the load before driving and at each fuel stop.

# Load Carrying

**Note:** Never place loads directly on the roof panel.

## Tow Bar Carriers

When using a tow bar attached carrier, consider the following:

- Do not exceed the maximum vertical load on the tow ball. This is the weight of the carrier plus the weight of the load. See **Towbar Dimensions** (page 474).
- Pay attention to the carrier manufacturer's specifications.
- If you are using a bike carrier, the maximum number of allowed bikes is three, with a maximum allowed weight of 130 lb (60 kg).
- Load the heaviest item closest to your vehicle.

## ROOF RACKS AND LOAD CARRIERS - VEHICLES WITHOUT: PANORAMIC ROOF OPENING PANEL



**WARNING:** Read and follow the manufacturer's instructions when you are fitting a roof rack.



**WARNING:** When loading the roof racks, we recommend you evenly distribute the load, as well as maintain a low center of gravity. Loaded vehicles, with higher centers of gravity, may handle differently than unloaded vehicles. Take extra precautions, such as slower speeds and increased stopping distance, when driving a heavily loaded vehicle.

The maximum recommended load, evenly distributed on the roof rack is 75 kg (165 lb).

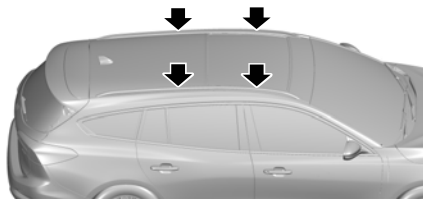

E282695

Fix the cross bars on the rail markings.

Make sure that you securely fasten the load. Check the tightness of the load before driving and at each fuel stop.

**Note:** Never place loads directly on the roof panel.

## Tow Bar Carriers

When using a tow bar attached carrier, consider the following:

- Do not exceed the maximum vertical load on the tow ball. This is the weight of the carrier plus the weight of the load. See **Towbar Dimensions** (page 472).
- Pay attention to the carrier manufacturer's specifications.
- If you are using a bike carrier, the maximum number of allowed bikes is three, with a maximum allowed weight of 130 lb (60 kg).
- Load the heaviest item closest to your vehicle.

# Luggage Compartment

---

## LUGGAGE COMPARTMENT HOOK

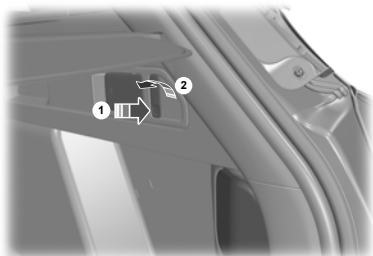

# Towing

## TOWING A TRAILER - 4-DOOR



**WARNING:** Your vehicle is not approved for trailer towing. Never tow a trailer with your vehicle.



**WARNING:** The anti-lock brake system does not control the trailer brakes.

## TOWING A TRAILER - 5-DOOR/ WAGON



**WARNING:** Do not exceed 100 km/h (60 mph). Failure to follow this instruction could result in the loss of control of your vehicle, personal injury or death.



**WARNING:** The rear tire pressures must be increased by 0.2 bar (3 psi) above specification. Do not exceed the maximum pressure stated on the tire sidewall. This could cause serious personal injury.



**WARNING:** Do not exceed the maximum gross vehicle weight stated on the vehicle identification plate. Failure to follow this instruction could result in personal injury.



**WARNING:** Towing trailers beyond the maximum recommended gross trailer weight exceeds the limit of your vehicle and could result in engine damage, transmission damage, structural damage, loss of vehicle control, vehicle rollover and personal injury.



**WARNING:** Do not exceed the maximum vertical load on the tow ball. Failure to follow this instruction could result in the loss of control of your vehicle, personal injury or death.

When towing a trailer:

- Obey country specific regulations for towing a trailer.
- Do not exceed 100 km/h (60 mph) even if a country allows higher speeds under certain conditions.
- Place loads as low as possible and central to the axle of your trailer. If you are towing with an unloaded vehicle, you should place the load in your trailer toward the front, within the maximum vertical load, as this gives the best stability.
- The trailer vertical weight on the tow ball is essential for the driving stability of your vehicle and trailer.
- The vertical weight on the tow ball should be at least 4% of the trailer weight and not exceed the maximum permissible weight.
- Reduce speed immediately if the trailer shows any sign of swaying. See **Trailer Sway Control** (page 379).
- Use a low gear when descending a steep slope.

**Note:** We recommend that you use a trailer safety cable. Read and follow the manufacturer's instructions when you use a trailer safety cable.

**Note:** The maximum permissible trailer vertical weight on the trailer identification plate is the trailer manufacturer's testing value. The vehicle maximum permissible trailer vertical weight may be lower.

The stability of your vehicle-to-trailer combination depends on the quality of the trailer.

# Towing

Towing a trailer changes the handling characteristics of your vehicle and increases stopping distances. Adapt your speed and driving behaviour to the load of the trailer.

The gross train weight stated on the vehicle identification plate applies for road gradients up to 12% and altitudes up to 1,000 m (3,281 ft) when towing a trailer. In mountainous regions the engine performance decreases due to lower air density with increasing altitude. In high altitude regions above 1,000 m (3,281 ft), you should reduce the stipulated maximum permitted gross train weight by 10% for every additional 1,000 m (3,281 ft).

**Note:** *Not all vehicles are suitable or approved to have a tow bar fitted. Ask an authorized dealer for more information.*

## TRAILER SWAY CONTROL

If the trailer begins to sway the stability control warning lamp flashes in the information display. The system applies the brakes to the individual wheels and reduces engine torque to aid vehicle stability.

Stop your vehicle as soon as it is safe to do so. Check the vertical weight on the tow ball and trailer load distribution. See **Capacities and Specifications** (page 471). See **Load Carrying** (page 370).

**Note:** *This feature does not prevent trailer sway, but reduces it once it begins.*

**Note:** *This feature cannot stop all trailers from swaying.*

**Note:** *In some cases, if your vehicle speed is too high, the system may turn on multiple times, gradually reducing your vehicle speed.*

## TOW BALL - VEHICLES WITH: DETACHABLE TOW BALL



**WARNING:** Do not exceed the lowest rating capacity for your vehicle or trailer hitch. Overloading your vehicle or trailer hitch can impair your vehicle stability and handling. Failure to follow this instruction could result in the loss of control of your vehicle, personal injury or death.



**WARNING:** Do not cut, drill, weld or modify the trailer hitch. Modifying the trailer hitch could reduce the hitch rating.

# Towing

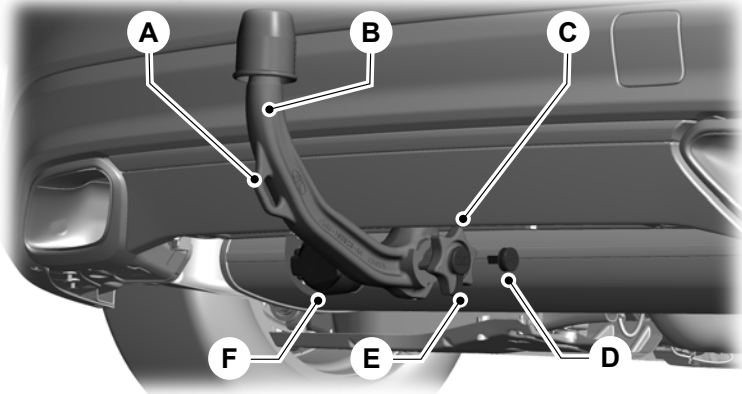

E269049

- A Trailer safety cable attachment point.
- B Tow ball arm in tow position.
- C Handwheel.
- D Key.
- E Protective cap.
- F Trailer wiring connection socket.

Do not disassemble or repair the tow ball arm.

## Detaching the Tow Ball Arm



**WARNING:** Always place the tow ball arm in a secure location in your vehicle so it does not become a projectile in a crash. Failure to follow this instruction could result in personal injury or death.

You must detach the tow ball arm when not in use. Securely stow the tow ball arm in the luggage compartment.

Never unlock or detach the tow ball arm with a trailer attached.

Do not use any tools to detach the tow ball arm.



# Towing

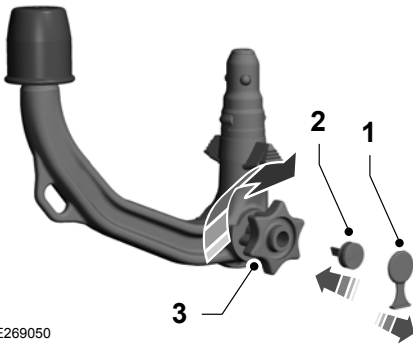

E269050

1. Remove the protective cap.
2. Insert the key and turn it clockwise to unlock the handwheel.
3. Hold the tow ball arm. Pull the handwheel outward and turn it fully clockwise until it clicks.

**Note:** The red mark on the handwheel must be within the green line on the tow ball arm.

4. Release the handwheel.
5. Pull the tow ball arm downward to remove it.
6. Turn the trailer wiring connection socket upward through 90 degrees until it engages in the end position.

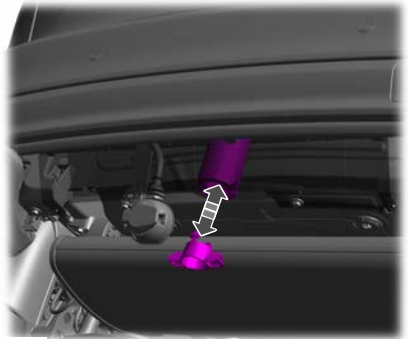

E265433

7. Insert the blanking plug.

## Attaching the Tow Ball Arm

Do not use any tools to attach the tow ball arm.

**Note:** You can only attach the tow ball arm if it is unlocked.

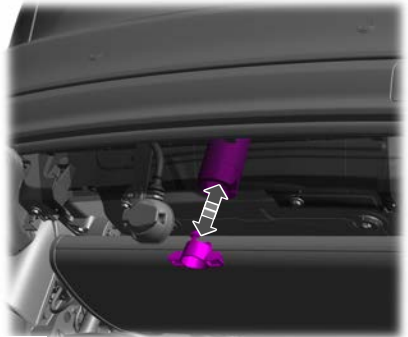

E265433

1. Remove the blanking plug.

# Towing

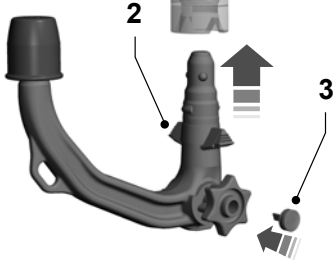

E269051

2. Fully insert the tow ball arm until it engages. Do not hold the handwheel.

**Note:** The green mark on the handwheel must be within the green line on the tow ball arm.

3. Insert the key and turn it counterclockwise to lock the handwheel.
4. Fit the protective cap. Fully push it back over the lock.
5. Turn the trailer wiring connection socket downward through 90 degrees until it engages in the end position.

## Tow Ball Arm Safety Checks

After you attach the tow ball arm, check the following:

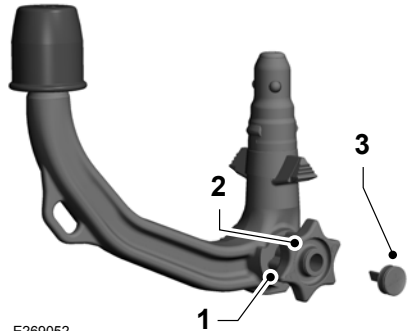

E269052

1. The green mark on the handwheel is within the green line on the tow ball arm.
2. You have locked the handwheel.
3. You have removed the key.

Do not use the tow ball arm if any of these cannot be met. Have your vehicle checked as soon as possible.

## Tow Ball Arm Guidelines

- Replacement keys are available. We recommend that you record the key number on the lock cylinder.
- Keep the system clean. Periodically lubricate bearings, sliding surfaces and locking balls with resin-free grease or oil. Lubricate the lock with graphite.

# Towing

- Remove the trailer wiring plug from the trailer wiring connection socket when not in use. Failure to do so may result in corrosion of the trailer wiring connection socket. Regularly clean the trailer wiring connection socket and make sure the socket cover is fully closed.
- If you use a high pressure water jet to clean your vehicle, disconnect the trailer wiring plug. Do not aim the water jet directly at the trailer wiring connection socket. We recommend that you detach the tow ball arm before washing your vehicle.

## TOW BALL - VEHICLES WITH: RETRACTABLE TOW BALL

**⚠ WARNING:** Do not exceed the lowest rating capacity for your vehicle or trailer hitch. Overloading your vehicle or trailer hitch can impair your vehicle stability and handling. Failure to follow this instruction could result in the loss of control of your vehicle, personal injury or death.

**⚠ WARNING:** Do not cut, drill, weld or modify the trailer hitch. Modifying the trailer hitch could reduce the hitch rating.

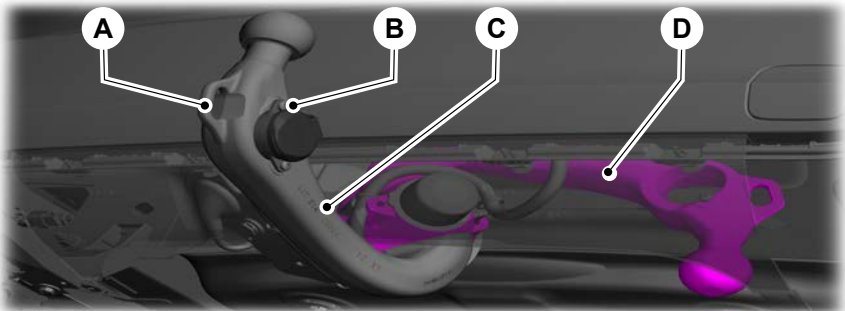

E265649

- A Trailer safety cable attachment point.
- B Trailer wiring connection socket.
- C Tow ball arm in tow position.
- D Tow ball arm in stowed position.

Do not disassemble or repair the tow ball arm or mechanism.

### Deploying the Tow Ball Arm

Do not use your foot or any tools to deploy the tow ball arm.

Do not touch the tow ball arm when it is deploying to the released position.

Do not use the tow ball arm if no tones sound when deploying the tow ball arm or when you lock it into position. Have your vehicle checked as soon as possible.

# Towing

The tow ball arm does not deploy if any of the following occur:

- Your vehicle is moving.
- The trailer wiring connection socket has a trailer wiring plug attached to it.
- The vehicle battery is not fully charged.



E237201

1. Press the button. It is on the right hand side of the luggage compartment.

**Note:** The LED on the button illuminates and a double tone sounds.



E265650

2. Press the button again within four seconds to deploy the tow ball arm to the released position.

**Note:** The LED on the button flashes and a series of tones sound when the tow ball arm deploys and reaches the released position.

**Note:** If you do not press the button again within four seconds, the system signals completion without deploying the tow ball arm. If the LED rapidly flashes and a high pitch tone sounds, repeat the process.

3. Manually move the tow ball arm into the tow position. Make sure the tow ball arm locks into position.

**Note:** The LED on the button stops flashing and a double tone sounds when the tow ball arm locks into position.

**Note:** A warning tone sounds for up to 30 seconds if the tow ball arm remains in an unlocked position.

If the deploy process is interrupted, for example tow ball arm movement is obstructed or the power supply is lost, the system must be reset. To reset the system fully repeat the process.

Check the following:

- Make sure the tow ball arm is fully locked. It must not move if jerked or when you attach a trailer.
- The LED is not flashing and no warning tones sound.

**Note:** If these cannot be met, do not use the tow ball arm. Have your vehicle checked as soon as possible.

## Retracting the Tow Ball Arm

You must retract the tow ball arm when not in use.

Do not use your foot or any tools to retract the tow ball arm.

Do not touch the tow ball arm when it is retracting to the released position.

Never retract the tow ball arm with a trailer attached. This can cause damage not covered by the vehicle Warranty.

The tow ball arm does not retract if any of the following occur:

- Your vehicle is moving.
- The trailer wiring connection socket has a trailer wiring plug attached to it.
- The vehicle battery is not fully charged.

# Towing

1. Disconnect the trailer wiring plug and unhitch the trailer or load carrier.



E237201

2. Press the button. It is on the right hand side of the luggage compartment.

**Note:** *The LED on the button illuminates and a double tone sounds.*



E265650

3. Press the button again within four seconds to retract the tow ball arm to the released position.

**Note:** *The LED on the button flashes and a series of tones sound when the tow ball arm retracts and reaches the released position.*

**Note:** *If you do not press the button again within four seconds, the system signals completion without retracting the tow ball arm. If the LED rapidly flashes and a high pitch tone sounds, repeat the process.*

4. Manually move the tow ball arm into the stowed position. Make sure the tow ball arm locks into position.

**Note:** *The LED on the button stops flashing and a double tone sounds when the tow ball arm locks into position.*

**Note:** *A warning tone sounds for up to 30 seconds if the tow ball arm remains in an unlocked position.*

## Tow Ball Arm Guidelines

- The tow ball arm mechanism is maintenance free. Do not grease or oil the mechanism.
- Remove the trailer wiring plug from the trailer wiring connection socket when not in use. Failure to do so may result in corrosion of the trailer wiring connection socket. Clean the trailer wiring connection socket regularly and make sure the socket cover is fully closed.
- If you use a high pressure water jet to clean your vehicle, disconnect the trailer wiring plug. Do not aim the water jet directly at the trailer wiring connection socket. We recommend that you retract the tow ball arm before washing your vehicle.

## TOWING THE VEHICLE ON FOUR WHEELS - 6-SPEED AUTOMATIC TRANSMISSION



**WARNING:** You must switch the ignition on when your vehicle is being towed. Failure to follow this warning could seriously increase the risk of injury or death.



**WARNING:** You must make sure the transmission selector lever is placed in position **N**. Failure to follow this warning could damage the transmission and may lead to a crash or injury.

# Towing



**WARNING:** The brake and steering assistance will not operate unless the engine is running. Press the brake pedal harder and allow for increased stopping distances and heavier steering. Failure to take care may lead to a crash or personal injury.



**WARNING:** If your vehicle has a steering wheel lock, make sure the ignition is in the accessory or on position before you tow.



**WARNING:** Too much tension on a tow rope could cause damage to your vehicle or the vehicle that is towing.



**WARNING:** Do not tow your vehicle if the ambient temperature is below 0°C (32°F).



**WARNING:** Do not tow your vehicle backward.

**Note:** If you need to exceed a speed of 50 km/h (30 mph) and a distance of 80 km (50 mi) while towing, you must lift the drive wheels clear of the ground.

**Note:** We recommend you do not tow with the drive wheels on the ground. However, if it is required to move the vehicle from a dangerous location, do not tow your vehicle faster than 50 km/h (30 mph) or farther than 80 km (50 mi).



**WARNING:** In the event of a mechanical failure of the transmission, do not use individual axle carriers. All wheels must be lifted clear of the ground on a level platform.

Drive off slowly and smoothly without jerking the vehicle that is being towed.

You must only use the towing eye that was delivered with your vehicle. See **Towing Points** (page 392).

Tow ropes or rigid towing bars must be placed on the same side. For example; right hand rear towing point to right hand front towing point.

You must use a tow rope or rigid towing bar that is of the correct strength for the weight of the towing vehicle and the vehicle that is being towed.

**Note:** Using a rigid towing bar is the safest way to tow a vehicle.

The weight of the vehicle that is being towed must not exceed the weight of the towing vehicle.

## Emergency Towing

If your vehicle is disabled without access to wheel dollies, a car-hauling trailer, or a flatbed transport vehicle it can be flat-towed with all wheels on the ground. You may do this under the following conditions:

- Your vehicle is facing forward so that it is towed in a forward direction.
- The transmission selector lever is placed in position **N**. If the transmission gear shift lever cannot be moved to position **N**, it may need to be overridden. See **Automatic Transmission** (page 241).
- Maximum speed is 50 km/h (30 mph).
- Maximum distance is 80 km (50 mi).

# Towing

## TOWING THE VEHICLE ON FOUR WHEELS - MANUAL TRANSMISSION



**WARNING:** You must switch the ignition on when your vehicle is being towed. Failure to follow this warning could seriously increase the risk of injury or death.



**WARNING:** The brake and steering assistance will not operate unless the engine is running. Press the brake pedal harder and be aware of increased stopping distances and heavier steering.



**WARNING:** If your vehicle has a steering wheel lock make sure the ignition is in the accessory or on position when being towed.



**WARNING:** Too much tension on a tow rope could cause damage to your vehicle or the vehicle that is towing.



**WARNING:** When towing your vehicle you must select neutral. Failure to follow this warning could damage the transmission and may lead to a crash or injury.

The weight of the vehicle that is being towed must not exceed the weight of the towing vehicle.

Do not exceed 50 km/h (31 mph).

## TOWING THE VEHICLE ON FOUR WHEELS - 7-SPEED AUTOMATIC TRANSMISSION/ 8-SPEED AUTOMATIC TRANSMISSION

If you need to tow your vehicle, contact a professional towing service or, if you are a member of a roadside assistance program, your roadside assistance service provider.

Drive off slowly and smoothly without jerking the vehicle you are towing.

You must only use the towing eye that was delivered with your vehicle. See **Towing Points** (page 392).

Tow ropes or rigid towing bars must be placed on the same side. For example; right hand rear towing point to right hand front towing point.

You must use a tow rope or rigid towing bar that is of the correct strength for the weight of the towing vehicle and the vehicle that is being towed.

# Driving Hints

## COLD WEATHER PRECAUTIONS

The functional operation of some components and systems can be affected at temperatures below approximately  $-25^{\circ}\text{C}$  ( $-13^{\circ}\text{F}$ ).

## BREAKING-IN

### Tires

You need to break in new tires for approximately 480 km (300 mi). During this time, your vehicle may exhibit some unusual driving characteristics.

### Brakes and Clutch

Avoid heavy use of the brakes and clutch if possible for the first 160 km (100 mi) in town and for the first 1,600 km (1,000 mi) on freeways.

## DRIVING ECONOMICALLY

The following helps to improve fuel consumption:

- Drive smoothly, accelerate gently and anticipate the road ahead to avoid heavy braking.
- Regularly check your tire pressures and make sure that they are inflated to the correct pressure.
- Follow the recommended maintenance schedule and carry out the recommended checks.
- Plan your journey and check the traffic before you set off. It is more efficient to combine errands into a single trip whenever possible.
- Avoid idling the engine in cold weather or for extended periods. Start the engine only when you are ready to set off.

- Do not carry unnecessary weight in your vehicle as extra weight wastes fuel.
- Do not add unnecessary accessories to the exterior of your vehicle, for example running boards. If you use a roof rack, remember to fold it down or remove it when not in use.
- Do not shift into neutral when you are braking or when your vehicle is slowing down.
- Shut all windows when driving at high speeds.
- Switch off all electric systems when not in use, for example air conditioning. Make sure that you unplug any accessories from the auxiliary power points when not in use.

## DRIVING THROUGH SHALLOW WATER



**WARNING:** Do not attempt to cross a deep or flowing body of water. Failure to follow this instruction could result in the loss of control of your vehicle, personal injury or death.

**Note:** *Driving through standing water can cause vehicle damage.*

**Note:** *Engine damage can occur if water enters the air filter.*

Before driving through standing water, check the depth. Never drive through water that is higher than the bottom of the front rocker area of your vehicle.



## Driving Hints



When driving through standing water, drive very slowly and do not stop your vehicle. Your brake performance and traction could be limited. After driving through water and as soon as it is safe to do so:

- Lightly press the brake pedal to dry the brakes and to check that they work.
- Turn the steering wheel to check that the steering power assist works.

Check the function of the following:

- Horn
- Exterior lights

### FLOOR MATS

**WARNING:** Use a floor mat designed to fit the footwell of your vehicle that does not obstruct the pedal area. Failure to follow this instruction could result in the loss of control of your vehicle, personal injury or death.

**WARNING:** Pedals that cannot move freely can cause loss of vehicle control and increase the risk of serious personal injury.

**WARNING:** Secure the floor mat to both retention devices so that it cannot slip out of position and interfere with the pedals. Failure to follow this instruction could result in the loss of control of your vehicle, personal injury or death.

**WARNING:** Do not place additional floor mats or any other covering on top of the original floor mats. This could result in the floor mat interfering with the operation of the pedals. Failure to follow this instruction could result in the loss of control of your vehicle, personal injury or death.

**WARNING:** Always make sure that objects cannot fall into the driver foot well while your vehicle is moving. Objects that are loose can become trapped under the pedals causing a loss of vehicle control.



To install the floor mats, position the floor mat eyelet over the retention post and press down to lock in position.

To remove the floor mat, reverse the installation procedure.

**Note:** Regularly check the floor mats to make sure they are secure.

# Roadside Emergencies

## HAZARD FLASHERS



The hazard flasher switch is on the instrument panel.

Use the hazard flashers if your vehicle is creating a safety hazard for other road users.

### Switching the Hazard Flashers On or Off



Press the button to switch the hazard flashers on.

Press the button again to switch the hazard flashers off.

**Note:** All direction indicators flash.

**Note:** Prolonged use of the hazard flashers could cause the vehicle battery to run out of charge.

**Note:** Depending on applicable laws in the country your vehicle was built for, if you heavily brake, the hazard flashers could turn on.

### Hazard Flasher Indicator



Flashes when you switch the hazard flashers on.

## FIRST AID KIT

The first aid kit can be stowed under the front passenger seat or in the luggage compartment.

## WARNING TRIANGLE

The warning triangle can be stowed under the front passenger seat.

## JUMP STARTING THE VEHICLE



**WARNING:** Keep batteries out of reach of children. Batteries contain sulfuric acid. Avoid contact with skin, eyes or clothing. Shield your eyes when working near the battery to protect against possible splashing of acid solution. In case of acid contact with skin or eyes, flush immediately with water for a minimum of 15 minutes and get prompt medical attention. If acid is swallowed, call a physician immediately.



**WARNING:** Batteries normally produce explosive gases which can cause personal injury. Therefore, do not allow flames, sparks or lighted substances to come near the battery. When working near the battery, always shield your face and protect your eyes. Always provide correct ventilation.



**WARNING:** Use only adequately sized cables with insulated clamps.

**Note:** Do not disconnect the battery of the disabled vehicle as this could damage the vehicle electrical system.

### Connecting the Jumper Cables

**Note:** In the illustration, the bottom vehicle represents the booster vehicle.

# Roadside Emergencies

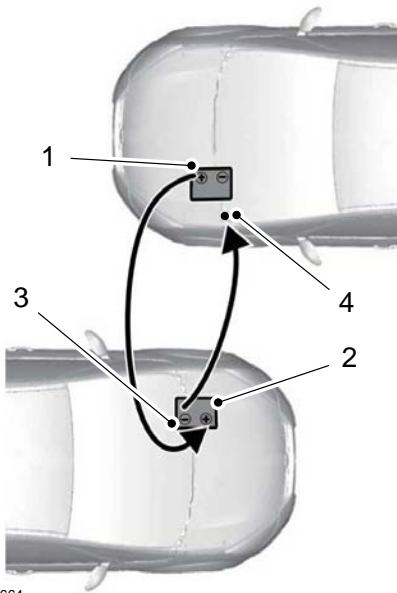

E142664

**WARNING:** Make sure that the cables are clear of any moving parts and fuel delivery system parts.

Park the booster vehicle close to the hood of the disabled vehicle, making sure the two vehicles do not touch.

Switch off the engine and any electrical equipment.

1. Connect the positive jumper cable to the positive terminal of the discharged battery.
2. Connect the other end of the positive jumper cable to the positive terminal of the assisting battery.
3. Connect the negative jumper cable to the negative terminal of the assisting battery.

4. Make the final connection of the negative jumper cable to an exposed metal part of the stalled vehicle's engine, or connect the negative cable to a ground connection point if available.

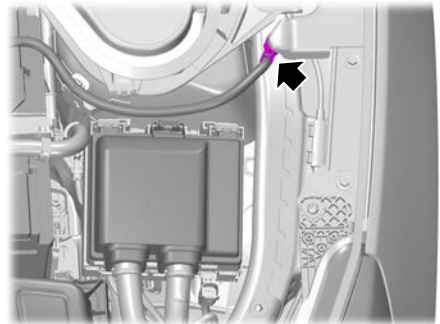

**WARNING:** Do not connect the end of the second cable to the negative (-) terminal of the battery to be jumped. A spark may cause an explosion of the gases that surround the battery.

**WARNING:** Make sure that the cables are clear of any moving parts and fuel delivery system parts.

## Starting the Engine

1. Start the engine of the booster vehicle and press the accelerator gently to keep the engine speed between 2000 and 3000 RPM.
2. Start the engine of the disabled vehicle.
3. Once the disabled vehicle has been started, run both vehicle engines for an additional three minutes before disconnecting the jumper cables.

# Roadside Emergencies

Remove the jumper cables in the reverse order that they were connected.

**Note:** Do not switch the headlamps on when disconnecting the cables. The peak voltage could blow the bulbs.

## TOWING POINTS

### Front Towing Point



E265228

1. Gently press and release the towing eye attachment point cover at the position indicated.
2. Gently pull it straight out.

**Note:** The towing eye attachment point cover has a small lanyard to keep it attached to the bumper.

### Rear Towing Point

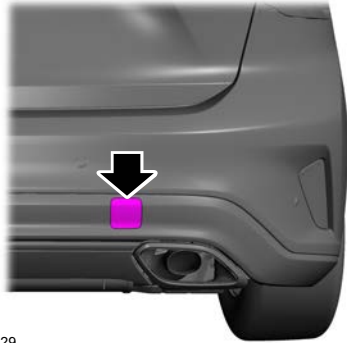

E265229

1. Gently press the top of the towing eye attachment point cover inward.
2. Gently lift it upward and then pull it straight out.

**Note:** The towing eye attachment point cover has a small lanyard to keep it attached to the bumper.

### Attaching the Towing Eye



**WARNING:** Make sure that the towing eye is fully tightened. Failure to follow this instruction could result in personal injury.



**WARNING:** You must switch the ignition on when your vehicle is being towed.

# Roadside Emergencies

---



E265230

1. Carefully remove the front or rear towing eye attachment point cover.
2. Install the towing eye.

**Note:** *It has a left-hand thread. Turn it counterclockwise to install it.*

## Towing Eye Location

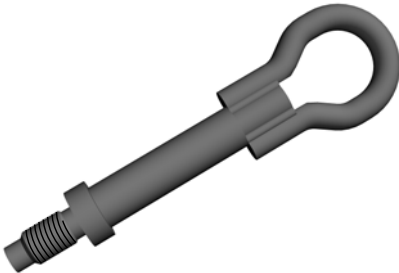

The towing eye is in the spare wheel storage tray.

**Note:** *You must carry the towing eye in your vehicle at all times.*

# Crash and Breakdown Information

## POST-CRASH ALERT SYSTEM

### What Is the Post-Crash Alert System

The system helps draw attention to your vehicle in the event of a serious impact.

### How Does the Post-Crash Alert System Work

The system is designed to turn the hazard flashers on and to intermittently sound the horn in the event of a serious impact that deploys an airbag or the seatbelt pretensioners.

### Post-Crash Alert System Limitations

Depending on applicable laws in the country your vehicle was built for, the horn does not sound in the event of a serious impact.

### Switching the Post-Crash Alert System Off

Press the hazard flasher switch or the unlock button on the remote control to switch the system off.

**Note:** *The alert turns off when the vehicle battery runs out of charge.*

## POST IMPACT BRAKING

### How Does Post Impact Braking Work

In the event of a moderate to severe crash, the braking system reduces the vehicle's speed in order to prevent or reduce the impact of a potential secondary crash.

## Post Impact Braking Limitations

Post impact braking does not activate if any of the following occur:

- The anti-lock braking system is damaged during the collision.
- Electronic stability control is disabled.
- Vehicle speed is below 10 km/h (5 mph).

## Overriding Post Impact Braking

You can override post impact braking by pressing the brake or accelerator pedal.

## Post Impact Braking Indicators



It flashes when a post impact braking event is occurring.

## AUTOMATIC CRASH SHUTOFF

### What Is Automatic Crash Shutoff

The automatic crash shutoff is designed to stop the fuel going to the engine in the event of a moderate or severe crash.

**Note:** *Not every impact causes a shutoff.*

### Automatic Crash Shutoff Precautions



**WARNING:** If your vehicle has been involved in a crash, have the fuel system checked. Failure to follow this instruction could result in fire, personal injury or death.

## Re-Enabling Your Vehicle

1. Switch the ignition off.

## Crash and Breakdown Information

---

2. Attempt to start your vehicle.
3. Switch the ignition off.
4. Attempt to start your vehicle.

**Note:** *If your vehicle does not start after the third attempt, have your vehicle checked as soon as possible.*

# Fuses

## FUSE BOX LOCATIONS

### Engine Compartment Fuse Box



E265225

### Passenger Compartment Fuse Box

The fuse box is below the glove compartment.

### Trailer Tow Module Fuse Box - 5-Door and Wagon



E267033

The fuse box is in the luggage compartment on the right-hand side.



# Fuses

## FUSE SPECIFICATION CHART

### Engine Compartment Fuse Box

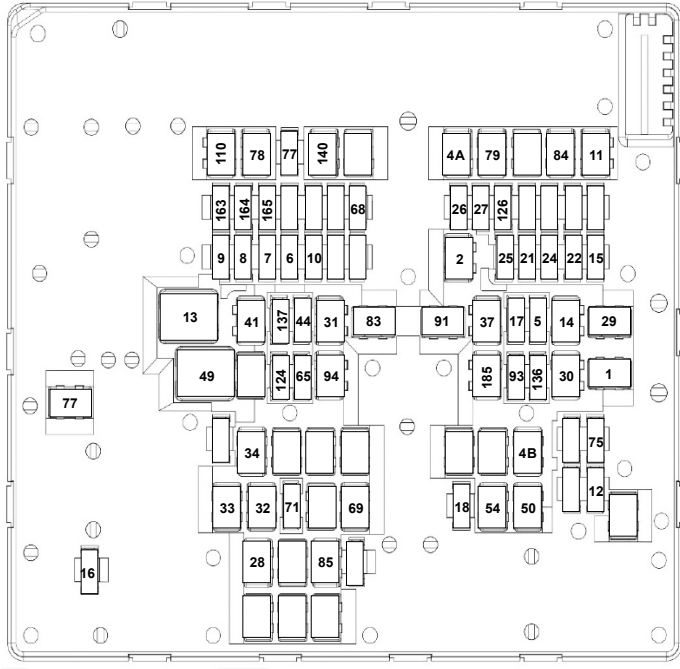

Fuse Location	Fuse Rating	Protected Component
1	40 A	Body control module.
2	30 A	Body control module.
4A	20 A	Fuel pump - diesel.
4B	20 A	Fuel pump - gasoline.
5	10 A	Data link connector.
6	15 A	Powertrain control module - gasoline.
	20 A	Powertrain control module - diesel.

# Fuses

<b>Fuse Location</b>	<b>Fuse Rating</b>	<b>Protected Component</b>
7	10 A	Powertrain control module.
8	15 A	Powertrain control module.
9	20 A	Powertrain control module.
10	10 A	Powertrain control module - gasoline.
11	30 A	Starter motor.
12	10 A	Air conditioning clutch.
13	40 A	Blower motor.
14	20 A	Auxiliary heater control module.
15	20 A	Horn.
16	20 A	Rear window washer pump.
17	5 A	Lumbar assembly.
18	20 A	Headlamp washer pump.
21	10 A	Headlamp leveling.
22	5 A	Electronic power assist steering.
24	10 A	Powertrain control module.
25	10 A	Front parking aid camera. Rear view camera. Blind spot information system. Reverse gear.
26	15 A	Transmission control module - diesel.
27	10 A	Electronic stability control.
28	40 A	Electronic stability control valve.
29	60 A	Electronic stability control pump.
30	25 A	Driver power seat.
31	25 A	Passenger power seat.
32	20 A	Auxiliary power point.
33	20 A	Auxiliary power point.
34	20 A	Auxiliary power point.

# Fuses

Fuse Location	Fuse Rating	Protected Component
37	20 A	Moonroof.
41	30 A	Power liftgate.
44	10 A	Stoplamp switch.
49	60 A	Cooling fan.
50	30 A	Heated back light.
54	20 A	Electronic limited slip differential - gasoline.
65	20 A	Transmission control module - diesel.
	5 A	Battery electronic control module - gasoline.
68	20 A	Steering column lock.
69	30 A	Windshield wipers.
71	20 A	Rear window wiper.
75	10 A	Mass air flow and intake air temperature sensor - gasoline.
77	10 A	Windshield heated washer jets. Heated windshield relay.
78	40 A	Left-hand heated windshield element.
79	40 A	Right-hand heated windshield element.
83	40 A	Auxiliary heater.
84	60 A	Auxiliary heater.
85	40 A	Auxiliary heater.
91	40 A	Trailer tow module.
93	5 A	Headlamps.
94	20 A	Heated seats.
110	30 A	Water-in-fuel sensor - diesel. Diesel fuel heater.
124	5 A	Rain sensor.
126	5 A	Dosing control unit - diesel.
136	15 A	Amplifier.

# Fuses

Fuse Location	Fuse Rating	Protected Component
137	15 A	Amplifier.
140	60 A	Glow plugs - diesel.
163	15 A	Dosing control unit pressure line heater.
164	10 A	Reductant dosage control module.
165	15 A	Tank heater - diesel.
185	20 A	Power windows. Moonroof.

## Passenger Compartment Fuse Box

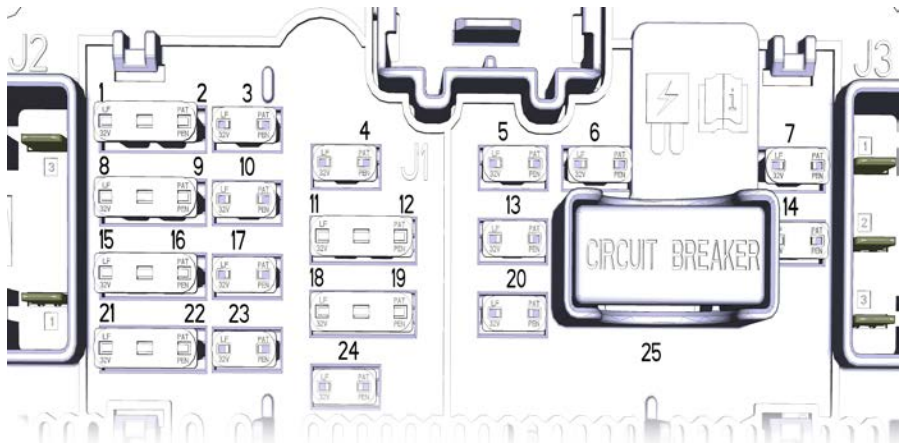

E249945

Fuse Location	Fuse Rating	Protected Component
1	5 A	Restraints control module.
2	5 A	In-vehicle temperature and humidity sensor.
3	10 A	Parking assist control module.
4	10 A	Ignition switch. Push button ignition switch.

# Fuses

Fuse Location	Fuse Rating	Protected Component
5	20 A	Central locking system.
6	10 A	Moonroof.
7	30 A	Right-hand mirror switch. Right-hand front power windows.
8	5 A	Headlamp control module.
9	5 A	Passenger airbag deactivation indicator. Auto-dimming interior mirror. Front parking aid camera.
10	10 A	Head up display module. Wireless accessory charging module.
11	5 A	Telematics modem.
12	5 A	Central security module.
13	15 A	Child safety locks. Fuel filler door. Central locking system.
14	30 A	Left-hand mirror switch. Left-hand front power windows.
15	15 A	Steering wheel module.
16	15 A	Adaptive damping module.
17	15 A	Voice control. Audio unit.
18	7.5 A	Power liftgate. Hands-free liftgate actuation module.
19	7.5 A	Battery back-up sounder.
20	10 A	Anti-theft alarm horn.
21	7.5 A	Climate control. E-shifter module.
22	7.5 A	Steering wheel module. Instrument cluster. Data link connector.

# Fuses

Fuse Location	Fuse Rating	Protected Component
23	20 A	Audio unit.
24	20 A	Not used (spare).
25	30 A	Not used (spare).

## Trailer Tow Module Fuse Box - 5-Door and Wagon

Fuse Location	Fuse Rating	Protected Component
1	15 A	Ignition system.

## CHANGING A FUSE

### General Information

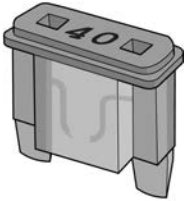

E217331

If electrical components in the vehicle are not working, a fuse may have blown. Blown fuses are identified by a broken wire within the fuse.

### Engine Compartment Fuse Box



**WARNING:** Always replace a fuse with one that has the specified amperage rating. Using a fuse with a higher amperage rating can cause severe wire damage and could start a fire.



E253688

1. Pull the latch toward you and remove the top cover.

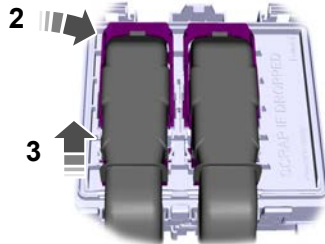

E253689

2. Pull the connector lever upward.
3. Pull the connector upward to remove it.

# Fuses

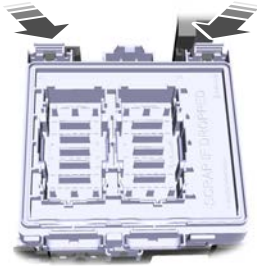

E253693

4. Pull both latches toward you and remove the fuse box.
5. Turn the fuse box over and open the lid.

## Passenger Compartment Fuse Box



**WARNING:** Always replace a fuse with one that has the specified amperage rating. Using a fuse with a higher amperage rating can cause severe wire damage and could start a fire.

1. Fold back the carpet under the glove compartment.
2. Carefully remove the cover.

## Trailer Tow Module Fuse Box - 5-Door and Wagon



**WARNING:** Always replace a fuse with one that has the specified amperage rating. Using a fuse with a higher amperage rating can cause severe wire damage and could start a fire.

1. Carefully remove the cover.
2. Fold back the carpet.

## Fuse Types

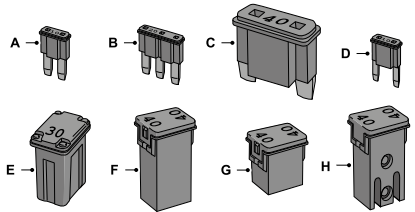

- A Micro 2.
- B Micro 3.
- C Maxi.
- D Mini.
- E M Case.
- F J Case.
- G J Case Low Profile.
- H Slotted M Case.

# Maintenance

## GENERAL INFORMATION



**WARNING:** Do not work on a hot engine.



**WARNING:** Switch the ignition off and apply the parking brake.



**WARNING:** Do not touch the electronic ignition system parts after you have switched the ignition on or when the engine is running. The system operates at high voltage. Failure to adhere to this warning could result in serious personal injury or death.



**WARNING:** Keep your hands and clothing clear of the engine cooling fan.

Under certain conditions, the engine cooling fan may continue to run for several minutes after you switch your vehicle off. See **Engine Cooling Fan** (page 423).

Make sure that you fit filler caps securely after carrying out maintenance checks.

We recommend that you carry out the following checks.

### Check Daily

- Exterior lamps.
- Interior lamps.
- Warning lamps and indicators.

### Check When Refueling

- Washer fluid level. See **Washer Fluid Check** (page 430).
- Tire pressures. See **Tire Pressures** (page 457).
- Tire condition. See **Wheels and Tires** (page 448).

### Check Monthly

- Engine oil level. See **Engine Oil Check** (page 421).
- Engine coolant level. See **Engine Coolant Check** (page 423).
- Brake fluid level. See **Brake Fluid Check** (page 427).
- Pipes, hoses and reservoirs for leaks.
- Air conditioning operation.
- Parking brake operation.
- Horn operation.
- Tightness of lug nuts. See **Lug Nuts** (page 462).

## OPENING AND CLOSING THE HOOD - LHD

### Opening the Hood

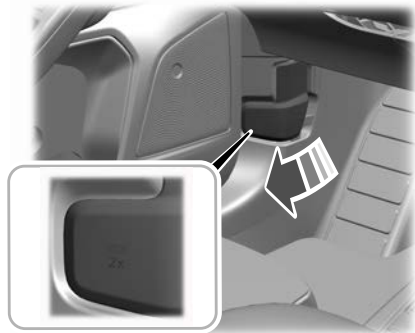

E263274

1. Open the left-hand front door.
2. Fully pull the hood release lever and let it completely retract.

**Note:** This action releases the hood latch.

3. Fully pull the hood release lever for a second time.

**Note:** This action fully releases the hood.



# Maintenance

4. Open the hood.

**Note:** *There is no secondary latch under the hood.*

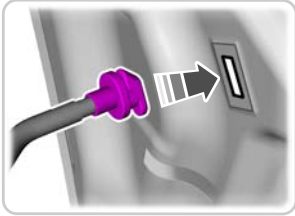

E193263

5. Support the hood with the strut.

## Closing the Hood

1. Remove the strut from the catch and secure it correctly in the clip.
2. Lower the hood and allow it to drop under its own weight for the last 25–35 cm (10–14 in).

**Note:** *Make sure that the hood is correctly closed.*

## Warning Lamps and Indicators



It illuminates when you switch the ignition on and remains on if any door or the hood is open.

## Information Messages

Message	Action
Bonnet open	Stop your vehicle as soon as it is safe to do so and close the hood.

# Maintenance

## OPENING AND CLOSING THE HOOD - RHD

### Opening the Hood

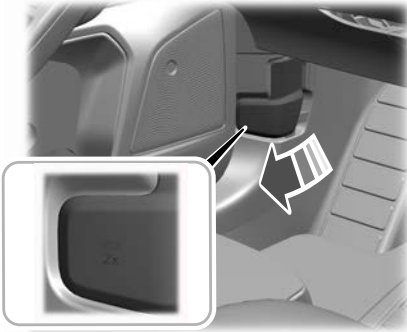

E263274

1. Open the left-hand front door.
2. Fully pull the hood release lever and let it completely retract.

**Note:** *This action releases the hood latch.*

3. Fully pull the hood release lever for a second time.

**Note:** *This action fully releases the hood.*

4. Open the hood.

**Note:** *There is no secondary latch under the hood.*

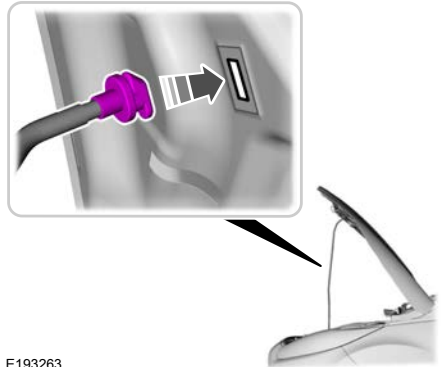

E193263

5. Support the hood with the strut.

**Note:** *Hold the yellow section of the hood strut.*

### Opening the Hood if the Passenger Door cannot be Opened

1. Unlock the right-hand front door using the key and access the left-hand front footwell. See **Unlocking and Locking the Doors Using the Remote Control** (page 76).

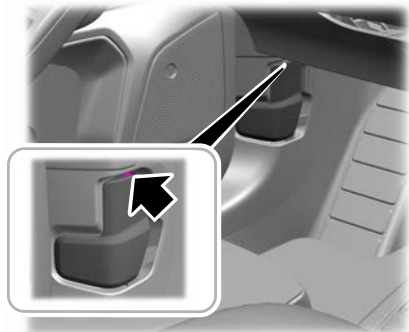

E263801

2. Insert a suitable tool, for example a screwdriver, in the position shown.

# Maintenance

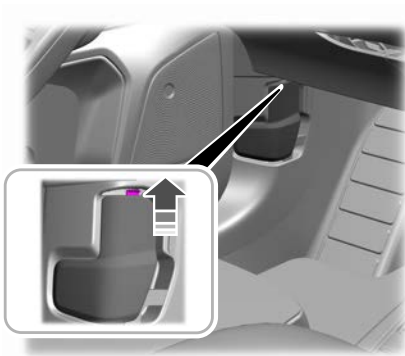

E263802

3. Gently pry the hood release lever securing clip upward.

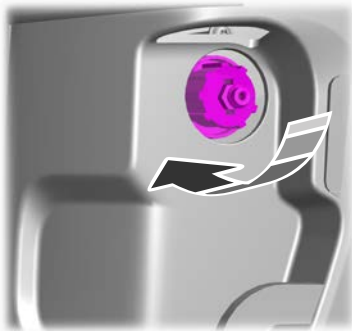

E263803

4. Use a suitable tool, for example a hexagonal socket, and turn the hood release mechanism clockwise until you feel a strong resistance.
  5. Let the hood release mechanism completely retract.
- Note:** This action releases the hood latch.
6. Turn the hood release mechanism clockwise until you feel a strong resistance for a second time.

**Note:** This action fully releases the hood.

7. Open the hood.

**Note:** There is no secondary latch under the hood.

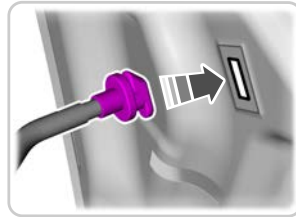

E193263

8. Support the hood with the strut.

**Note:** Hold the yellow section of the hood strut.

9. Reinstall the hood release lever. To install, reverse the removal procedure.

**Note:** Make sure the hood release lever securing clip is fully engaged.

## Closing the Hood

1. Remove the strut from the catch and secure it correctly in the clip.
2. Lower the hood and allow it to drop under its own weight for the last 25–35 cm (10–14 in).

**Note:** Make sure that the hood is correctly closed.

## Warning Lamps and Indicators



It illuminates when you switch the ignition on and remains on if any door or the hood is open.

# Maintenance

## Information Messages

Message	Action
Bonnet open	Stop your vehicle as soon as it is safe to do so and close the hood.

## UNDER HOOD OVERVIEW - 1.0L ECOBOOST™, LHD

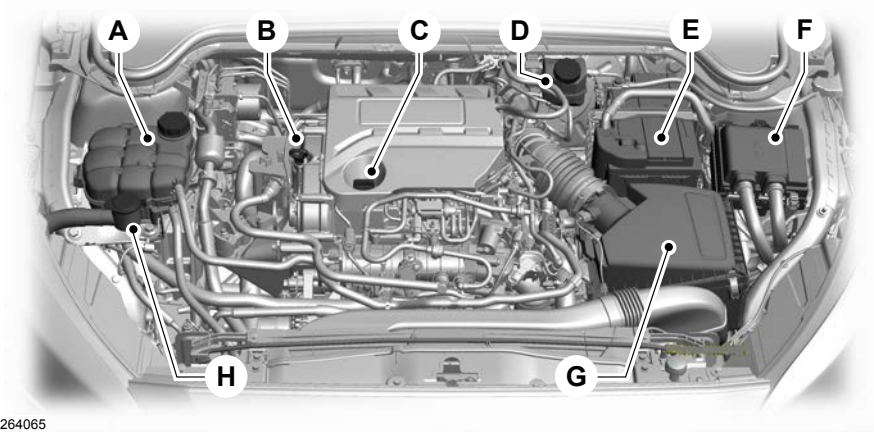

E264065

- A Engine coolant reservoir. See **Engine Coolant Check** (page 423).
- B Engine oil dipstick. See **Engine Oil Dipstick** (page 420).
- C Engine oil filler cap. See **Engine Oil Check** (page 421).
- D Brake fluid reservoir. See **Brake Fluid Check** (page 427).
- E Battery. See **Changing the 12V Battery** (page 428).
- F Engine compartment fuse box. See **Fuses** (page 396).
- G Air filter.
- H Windshield and rear window washer reservoir. See **Washer Fluid Check** (page 430).

# Maintenance

## UNDER HOOD OVERVIEW - 1.0L ECOBOOST™, RHD

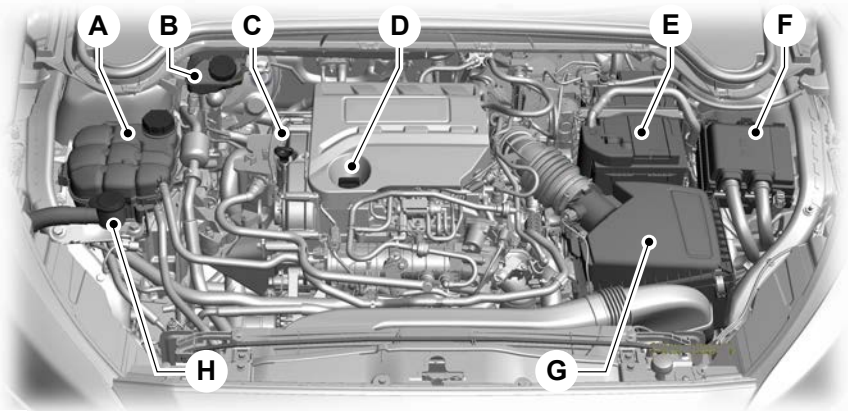

E264072

- A Engine coolant reservoir. See **Engine Coolant Check** (page 423).
- B Brake fluid reservoir. See **Brake Fluid Check** (page 427).
- C Engine oil dipstick. See **Engine Oil Dipstick** (page 420).
- D Engine oil filler cap. See **Engine Oil Check** (page 421).
- E Battery. See **Changing the 12V Battery** (page 428).
- F Engine compartment fuse box. See **Fuses** (page 396).
- G Air filter.
- H Windshield and rear window washer reservoir. See **Washer Fluid Check** (page 430).

# Maintenance

## UNDER HOOD OVERVIEW - 1.5L TIVCT, LHD

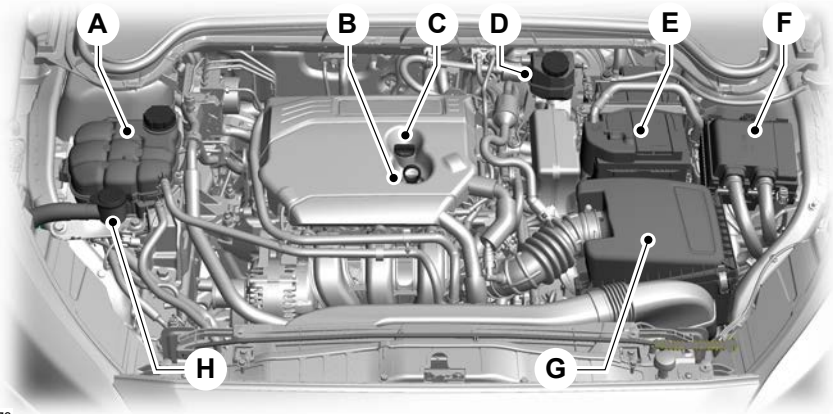

E264073

- A Engine coolant reservoir. See **Engine Coolant Check** (page 423).
- B Engine oil dipstick. See **Engine Oil Dipstick** (page 420).
- C Engine oil filler cap. See **Engine Oil Check** (page 421).
- D Brake fluid reservoir. See **Brake Fluid Check** (page 427).
- E Battery. See **Changing the 12V Battery** (page 428).
- F Engine compartment fuse box. See **Fuses** (page 396).
- G Air filter.
- H Windshield and rear window washer reservoir. See **Washer Fluid Check** (page 430).

# Maintenance

## UNDER HOOD OVERVIEW - 1.5L TIVCT, RHD

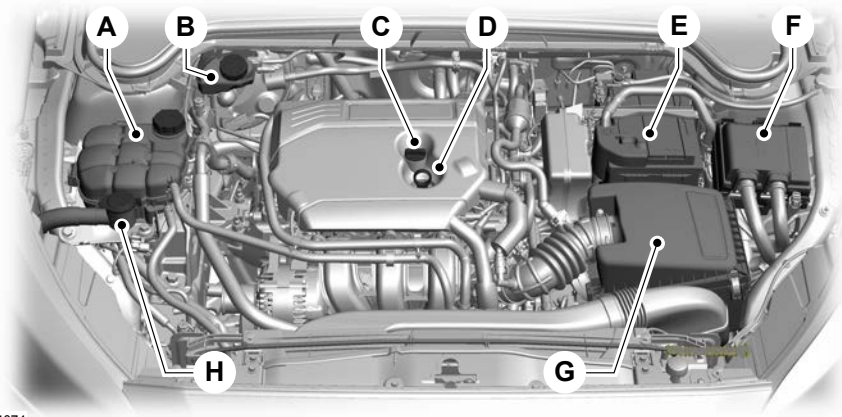

E264074

- A Engine coolant reservoir. See **Engine Coolant Check** (page 423).
- B Brake fluid reservoir. See **Brake Fluid Check** (page 427).
- C Engine oil filler cap. See **Engine Oil Check** (page 421).
- D Engine oil dipstick. See **Engine Oil Dipstick** (page 420).
- E Battery. See **Changing the 12V Battery** (page 428).
- F Engine compartment fuse box. See **Fuses** (page 396).
- G Air filter.
- H Windshield and rear window washer reservoir. See **Washer Fluid Check** (page 430).

# Maintenance

## UNDER HOOD OVERVIEW - 1.5L ECOBLUE, LHD

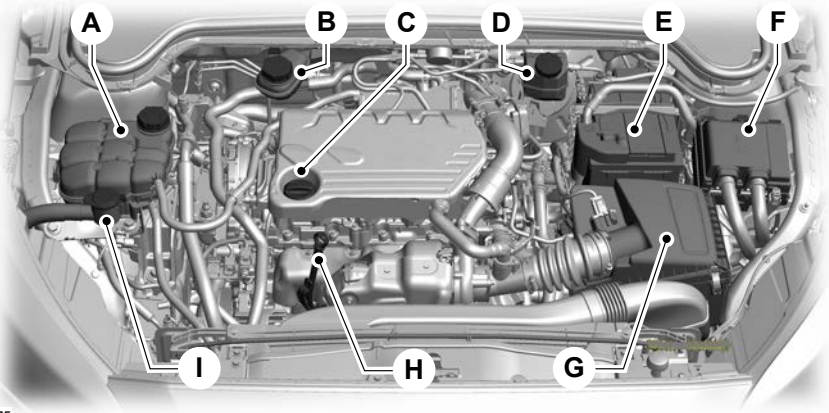

E264075

- A Engine coolant reservoir. See **Engine Coolant Check** (page 423).
- B Engine cooling system overflow reservoir. See **Engine Coolant Check** (page 423).
- C Engine oil filler cap. See **Engine Oil Check** (page 421).
- D Brake fluid reservoir. See **Brake Fluid Check** (page 427).
- E Battery. See **Changing the 12V Battery** (page 428).
- F Engine compartment fuse box. See **Fuses** (page 396).
- G Air filter.
- H Engine oil dipstick. See **Engine Oil Dipstick** (page 420).
- I Windshield and rear window washer reservoir. See **Washer Fluid Check** (page 430).



# Maintenance

## UNDER HOOD OVERVIEW - 1.5L ECOBLUE, RHD

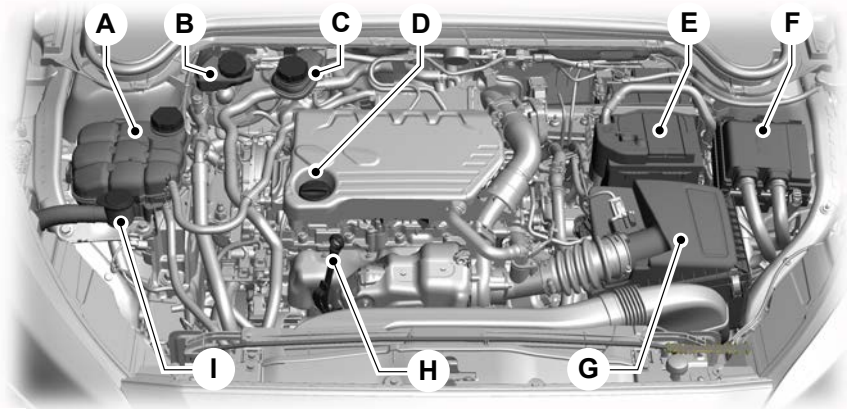

E264076

- A Engine coolant reservoir. See **Engine Coolant Check** (page 423).
- B Brake fluid reservoir. See **Brake Fluid Check** (page 427).
- C Engine cooling system overflow reservoir. See **Engine Coolant Check** (page 423).
- D Engine oil filler cap. See **Engine Oil Check** (page 421).
- E Battery. See **Changing the 12V Battery** (page 428).
- F Engine compartment fuse box. See **Fuses** (page 396).
- G Air filter.
- H Engine oil dipstick. See **Engine Oil Dipstick** (page 420).
- I Windshield and rear window washer reservoir. See **Washer Fluid Check** (page 430).

# Maintenance

## UNDER HOOD OVERVIEW - 1.5L ECOBOOST™, LHD

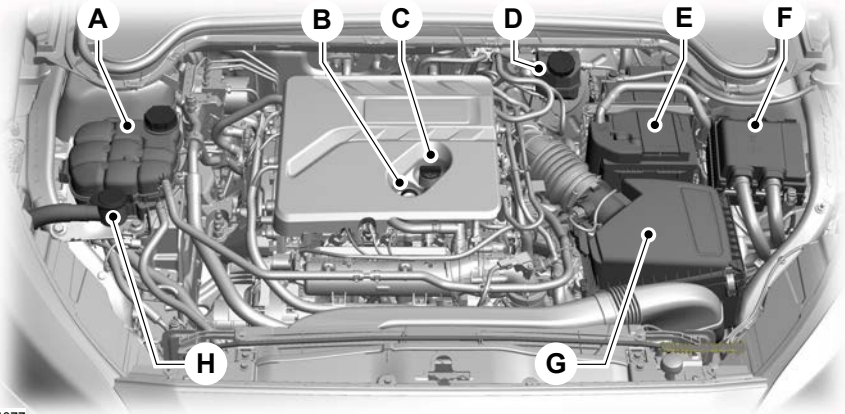

E264077

- A Engine coolant reservoir. See **Engine Coolant Check** (page 423).
- B Engine oil dipstick. See **Engine Oil Dipstick** (page 420).
- C Engine oil filler cap. See **Engine Oil Check** (page 421).
- D Brake fluid reservoir. See **Brake Fluid Check** (page 427).
- E Battery. See **Changing the 12V Battery** (page 428).
- F Engine compartment fuse box. See **Fuses** (page 396).
- G Air filter.
- H Windshield and rear window washer reservoir. See **Washer Fluid Check** (page 430).

# Maintenance

## UNDER HOOD OVERVIEW - 1.5L ECOBOOST™, RHD

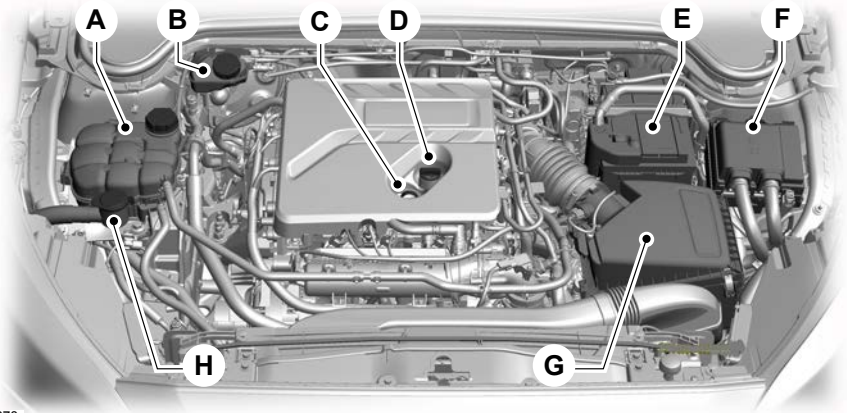

E264078

- A Engine coolant reservoir. See **Engine Coolant Check** (page 423).
- B Brake fluid reservoir. See **Brake Fluid Check** (page 427).
- C Engine oil dipstick. See **Engine Oil Dipstick** (page 420).
- D Engine oil filler cap. See **Engine Oil Check** (page 421).
- E Battery. See **Changing the 12V Battery** (page 428).
- F Engine compartment fuse box. See **Fuses** (page 396).
- G Air filter.
- H Windshield and rear window washer reservoir. See **Washer Fluid Check** (page 430).

# Maintenance

## UNDER HOOD OVERVIEW - 2.0L ECOBLUE, LHD

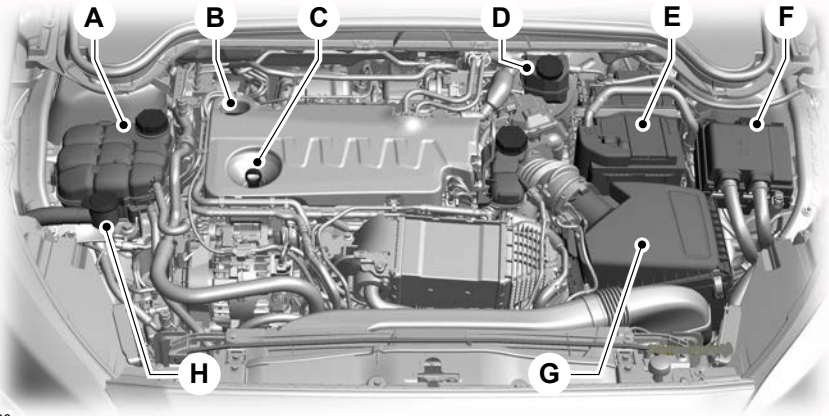

E268806

- A Engine coolant reservoir. See **Engine Coolant Check** (page 423).
- B Engine oil filler cap. See **Engine Oil Check** (page 421).
- C Engine oil dipstick. See **Engine Oil Dipstick** (page 420).
- D Brake fluid reservoir. See **Brake Fluid Check** (page 427).
- E Battery. See **Changing the 12V Battery** (page 428).
- F Engine compartment fuse box. See **Fuses** (page 396).
- G Air filter.
- H Windshield and rear window washer reservoir. See **Washer Fluid Check** (page 430).

# Maintenance

## UNDER HOOD OVERVIEW - 2.0L ECOBLUE, RHD

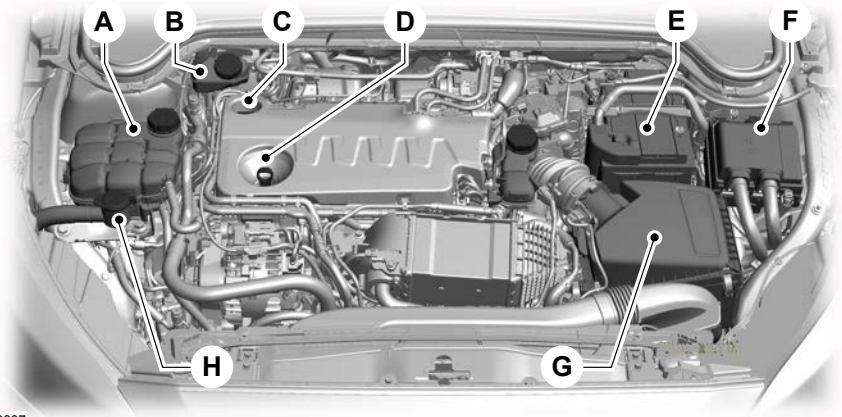

E268807

- A Engine coolant reservoir. See **Engine Coolant Check** (page 423).
- B Brake fluid reservoir. See **Brake Fluid Check** (page 427).
- C Engine oil filler cap. See **Engine Oil Check** (page 421).
- D Engine oil dipstick. See **Engine Oil Dipstick** (page 420).
- E Battery. See **Changing the 12V Battery** (page 428).
- F Engine compartment fuse box. See **Fuses** (page 396).
- G Air filter.
- H Windshield and rear window washer reservoir. See **Washer Fluid Check** (page 430).

# Maintenance

## UNDER HOOD OVERVIEW - 2.3L ECOBOOST™, LHD

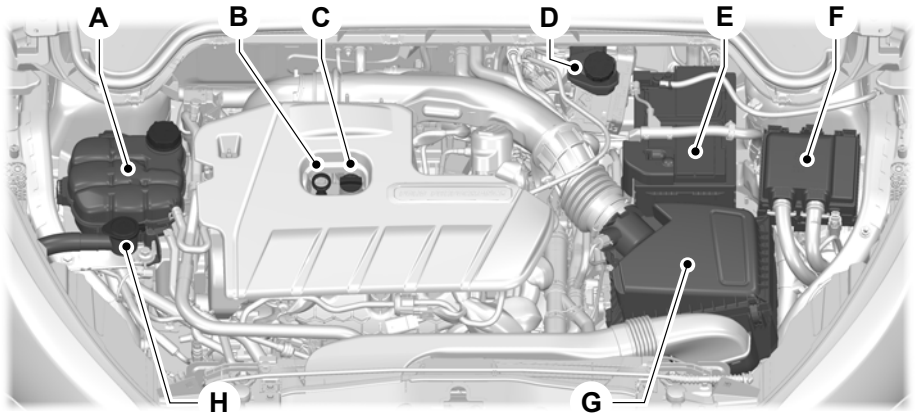

E294376

- A Engine coolant reservoir. See **Engine Coolant Check** (page 423).
- B Engine oil dipstick. See **Engine Oil Dipstick** (page 421).
- C Engine oil filler cap. See **Engine Oil Check** (page 421).
- D Brake fluid reservoir. See **Brake Fluid Check** (page 427).
- E Battery. See **Changing the 12V Battery** (page 428).
- F Engine compartment fuse box. See **Fuses** (page 396).
- G Air filter.
- H Windshield and rear window washer reservoir. See **Washer Fluid Check** (page 430).

# Maintenance

## UNDER HOOD OVERVIEW - 2.3L ECOBOOST™, RHD

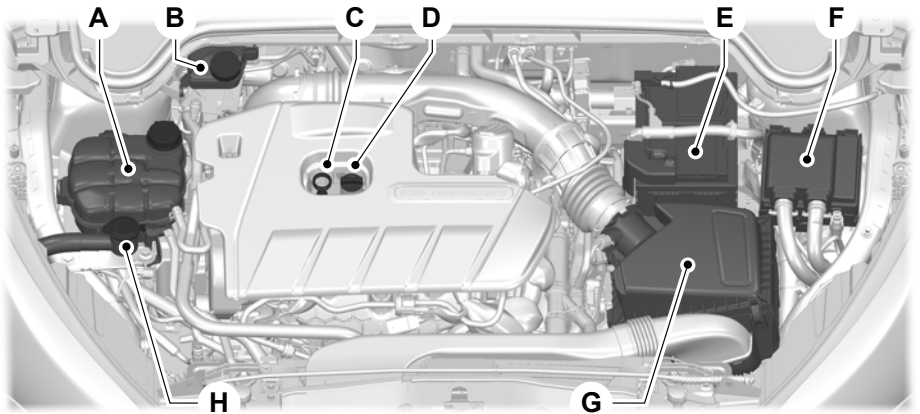

E294377

- A Engine coolant reservoir. See **Engine Coolant Check** (page 423).
- B Brake fluid reservoir. See **Brake Fluid Check** (page 427).
- C Engine oil dipstick. See **Engine Oil Dipstick** (page 421).
- D Engine oil filler cap. See **Engine Oil Check** (page 421).
- E Battery. See **Changing the 12V Battery** (page 428).
- F Engine compartment fuse box. See **Fuses** (page 396).
- G Air filter.
- H Windshield and rear window washer reservoir. See **Washer Fluid Check** (page 430).

# Maintenance

## ENGINE OIL DIPSTICK - 1.0L ECOBOOST™/1.5L TIVCT

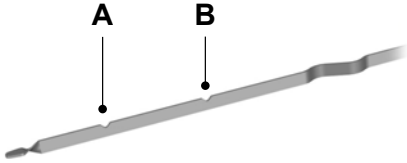

E141337

- A Minimum.
- B Maximum.

## ENGINE OIL DIPSTICK - 1.5L ECOBOOST™

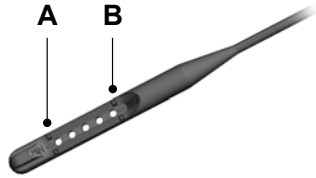

E264320

- A Minimum.
- B Maximum.

## ENGINE OIL DIPSTICK - 1.5L ECOBLUE

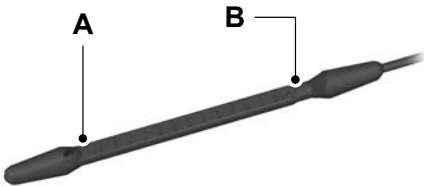

E140423

- A Minimum.
- B Maximum.

## ENGINE OIL DIPSTICK - 2.0L ECOBLUE

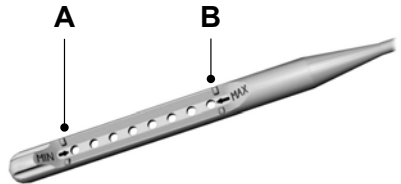

E226469

- A Minimum.
- B Maximum.



# Maintenance

## ENGINE OIL DIPSTICK - 2.3L ECOBOOST™

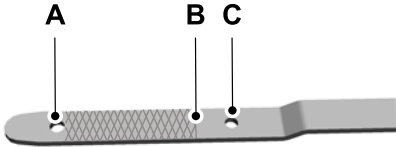

- A Minimum.
- B Nominal.
- C Maximum.

## ENGINE OIL CHECK

1. Make sure that your vehicle is on level ground.
2. Check the oil level before starting the engine, or switch the engine off after warm up and wait 10 minutes for the oil to drain into the oil pan.
3. Remove the dipstick and wipe it with a clean, lint-free cloth.
4. Reinstall the dipstick and make sure it is fully seated.
5. Remove the dipstick again to check the oil level.

**Note:** *If the oil level is between the maximum and minimum marks, the oil level is acceptable. Do not add oil.*

6. If the oil level is at the minimum mark, immediately add oil.
7. Reinstall the dipstick. Make sure it is fully seated.

**Note:** *The oil consumption of new engines reaches its normal level after approximately 5,000 km (3,000 mi).*

## Adding Engine Oil

 **WARNING:** Do not add engine oil when the engine is hot. Failure to follow this instruction could result in personal injury.

 **WARNING:** Do not remove the filler cap when the engine is running.

Do not use supplemental engine oil additives because they are unnecessary and could lead to engine damage that the vehicle warranty may not cover.

1. Clean the area surrounding the engine oil filler cap before you remove it.
2. Remove the engine oil filler cap.
3. Add engine oil that meets our specifications.
4. Reinstall the engine oil filler cap. Turn it clockwise until you feel a strong resistance.

**Note:** *Do not add oil further than the maximum mark. Oil levels above the maximum mark may cause engine damage.*

**Note:** *Immediately soak up any oil spillage with an absorbent cloth.*

## Engine Oil Pressure Warning Lamp

 **WARNING:** If it illuminates when you are driving do not continue your journey, even if the oil level is correct. Have your vehicle checked.



It illuminates when you switch the ignition on.

# Maintenance

---

If it illuminates when the engine is running this indicates a malfunction. Stop your vehicle as soon as it is safe to do so and switch the engine off. Check the engine oil level. If the oil level is sufficient, this indicates a system malfunction. Have your vehicle checked as soon as possible.

## **OIL CHANGE INDICATOR RESET - VEHICLES WITH: 4.2 INCH INSTRUMENT CLUSTER DISPLAY SCREEN**

Only reset the system after changing the engine oil and oil filter.

**To reset the oil change indicator, use the information display controls on the steering wheel to select the following:**

<b>Menu item</b>	<b>Action</b>
Settings	Press the menu button.
Information	Press the <b>OK</b> button.
Oil life	Press the <b>OK</b> button.
Reset oil life	Press and hold the <b>OK</b> button until the system reset confirmation appears.

# Maintenance

## OIL CHANGE INDICATOR RESET - VEHICLES WITH: 12.3 INCH INSTRUMENT CLUSTER DISPLAY SCREEN

1. Press the menu button on the steering wheel to enter the information display main menu.
2. Select **Settings**.
3. Select **Vehicle**.
4. Select **Oil life**.
5. Press and hold the **OK** button until the system reset confirmation appears.

## ENGINE COOLING FAN - GASOLINE



**WARNING:** Keep your hands and clothing clear of the engine cooling fan.

Under certain conditions, the engine cooling fan may continue to run for several minutes after you switch your vehicle off.

## ENGINE COOLING FAN - DIESEL



**WARNING:** Keep your hands and clothing clear of the engine cooling fan.

Under certain conditions, the engine cooling fan may continue to run for several minutes after you switch your vehicle off. This could happen in low ambient temperatures and independent of the engine coolant temperature, for example short journeys or low coolant temperature. See **Diesel Particulate Filter** (page 225).

## ENGINE COOLANT CHECK



**WARNING:** Do not remove the coolant reservoir cap when the engine is on or the cooling system is hot. Wait 10 minutes for the cooling system to cool down. Cover the coolant reservoir cap with a thick cloth to prevent the possibility of scalding and slowly remove the cap. Failure to follow this instruction could result in personal injury.



**WARNING:** Do not put coolant in the windshield washer reservoir. If sprayed on the windshield, coolant could make it difficult to see through the windshield.



**WARNING:** To reduce the risk of personal injury, make sure the engine is cool before unscrewing the coolant pressure relief cap. The cooling system is under pressure. Steam and hot liquid can come out forcefully when you loosen the cap slightly.



**WARNING:** Do not add coolant further than the **MAX** mark.

When the engine is cold, check the concentration and level of the coolant at the intervals listed in the scheduled maintenance information.

**Note:** Make sure that the coolant level is between the **MIN** and the **MAX** marks on the coolant reservoir.

**Note:** Coolant expands when it is hot. The level may extend beyond the **MAX** mark.

# Maintenance

Maintain coolant concentration within 48% to 50%, which equates to a freeze point between -34°C (-29°F) and -37°C (-35°F). Coolant concentration should be checked using a refractometer. We do not recommend the use of hydrometers or coolant test strips for measuring coolant concentration.

## Adding Coolant



**WARNING:** Do not add engine coolant when the engine is on or the cooling system is hot. Failure to follow this instruction could result in personal injury.



**WARNING:** Do not remove the coolant reservoir cap when the engine is on or the cooling system is hot. Wait 10 minutes for the cooling system to cool down. Cover the coolant reservoir cap with a thick cloth to prevent the possibility of scalding and slowly remove the cap. Failure to follow this instruction could result in personal injury.



**WARNING:** Do not put coolant in the windshield washer reservoir. If sprayed on the windshield, coolant could make it difficult to see through the windshield.

**Note:** Do not use stop leak pellets, cooling system sealants, or non-specified additives as they can cause damage to the engine cooling or heating systems. Resulting component damage may not be covered by the vehicle Warranty.

**Note:** Automotive fluids are not interchangeable.

It is very important to use prediluted coolant approved to the correct specification in order to avoid plugging the small passageways in the engine cooling system. See **Capacities and Specifications** (page 485). Do not mix different colors or types of coolant in your vehicle. Mixing of engine coolants or using an incorrect coolant may harm the engine or cooling system components and may not be covered by the vehicle Warranty.

**Note:** If prediluted coolant is not available, use the approved concentrated coolant diluting it to 50/50 with distilled water. See **Capacities and Specifications** (page 485). Using water that has not been deionised may contribute to deposit formation, corrosion and plugging of the small cooling system passageways.

**Note:** Coolants marketed for all makes and models may not be approved to our specifications and may cause damage to the cooling system. Resulting component damage may not be covered by the vehicle Warranty.

If the coolant level is at or below the minimum mark, add prediluted coolant immediately.

To top up the coolant level do the following:

1. Unscrew the cap slowly. Any pressure escapes as you unscrew the cap.
2. Add prediluted coolant approved to the correct specification. See **Capacities and Specifications** (page 485).
3. Add enough prediluted coolant to reach the correct level.
4. Replace the coolant reservoir cap. Turn the cap clockwise until it contacts the hard stop.

# Maintenance

---

5. Check the coolant level in the coolant reservoir the next few times you drive your vehicle. If necessary, add enough prediluted engine coolant to bring the coolant level to the correct level.

If you have to add more than 1 L (1.1 qt) of engine coolant per month, have your vehicle checked as soon as possible. Operating an engine with a low level of coolant can result in engine overheating and possible engine damage.

In case of emergency, you can add a large amount of water without engine coolant in order to reach a vehicle service location. In this instance, qualified personnel:

1. Must drain the cooling system.
2. Chemically clean the coolant system.
3. Refill with engine coolant as soon as possible.

Water alone, without engine coolant, can cause engine damage from corrosion, overheating or freezing.

Do not use the following as a coolant substitute:

- Alcohol.
- Methanol.
- Brine.
- Any coolant mixed with alcohol or methanol antifreeze.

Alcohol and other liquids can cause engine damage from overheating or freezing.

Do not add extra inhibitors or additives to the coolant. These can be harmful and compromise the corrosion protection of the coolant.

## Recycled Coolant

We do not recommend the use of recycled coolant as an approved recycling process is not yet available.

**Note:** *Dispose of used coolant in the appropriate manner.*

Follow your community's regulations and standards for recycling and disposing of automotive fluids.

## Severe Climates

If you drive in extremely cold climates:

- It may be necessary to increase the coolant concentration above 50%.
- A coolant concentration of 60% provides improved freeze point protection.
- Coolant concentrations above 60% decrease the overheat protection characteristics of the coolant and may cause engine damage.

If you drive in extremely hot climates:

- You can decrease the coolant concentration to 40%.
- A coolant concentration of 40% provides improved overheat protection.
- Coolant concentrations below 40% decrease the overheat and corrosion protection characteristics of the coolant and may cause engine damage.

Vehicles driven year-round in non-extreme climates should use prediluted coolant for optimum cooling system and engine protection.

## Coolant Change

At specific mileage intervals, as listed in the scheduled maintenance information, the coolant should be changed. Add prediluted coolant approved to the correct specification. See **Capacities and Specifications** (page 485).

# Maintenance

## Fail-Safe Cooling

Fail-safe cooling allows you to temporarily drive your vehicle before any incremental component damage occurs. The fail-safe distance depends on ambient temperature, vehicle load and terrain.

### How Fail-Safe Cooling Works



If the engine begins to overheat, the coolant temperature gauge moves toward the red zone:



A warning lamp illuminates and a message may appear in the information display.

If the engine reaches a preset over-temperature condition, the engine automatically switches to alternating cylinder operation. Each disabled cylinder acts as an air pump and cools the engine.

When this occurs, your vehicle still operates, however:

- Engine power is limited.
- The air conditioning system turns off.

Continued operation increases the engine temperature, causing the engine to completely shut down. Your steering and braking effort increases in this situation.

When the engine temperature cools, you can re-start the engine. Have your vehicle checked as soon as possible to minimize engine damage.

### When Fail-Safe Mode Is Activated



**WARNING:** Fail-safe mode is for use during emergencies only. Operate your vehicle in fail-safe mode only as long as necessary to bring your vehicle to rest in a safe location and seek immediate repairs. When in fail-safe mode, your vehicle will have limited power, will not be able to maintain

high-speed operation, and may completely shut down without warning, potentially losing engine power, power steering assist, and power brake assist, which may increase the possibility of a crash resulting in serious injury.



**WARNING:** Do not remove the coolant reservoir cap when the engine is on or the cooling system is hot. Wait 10 minutes for the cooling system to cool down. Cover the coolant reservoir cap with a thick cloth to prevent the possibility of scalding and slowly remove the cap. Failure to follow this instruction could result in personal injury.

Your vehicle has limited engine power when in the fail-safe mode, drive your vehicle with caution. Your vehicle does not maintain high-speed operation and the engine may operate poorly.

Remember that the engine is capable of automatically shutting down to prevent engine damage. In this situation:

1. Pull off the road as soon as safely possible and switch the engine off.
2. If you are a member of a roadside assistance program, we recommend that you contact your roadside assistance service provider.
3. If this is not possible, wait for a short period of time for the engine to cool.
4. Check the coolant level. If the coolant level is at or below the minimum mark, add prediluted coolant immediately.
5. When the engine temperature cools, you can re-start the engine. Have your vehicle checked as soon as possible to minimize engine damage.

**Note:** *Driving your vehicle without repair increases the chance of engine damage.*

# Maintenance

## Engine Coolant Temperature Management (if Equipped)



**WARNING:** To reduce the risk of crash and injury, be prepared that the vehicle speed may reduce and the vehicle may not be able to accelerate with full power until the coolant temperature reduces.

If you tow a trailer with your vehicle, the engine may temporarily reach a higher temperature during severe operating conditions, for example ascending a long or steep grade in high ambient temperatures.

At this time, you may notice the coolant temperature gauge moves toward the red zone and a message may appear in the information display.

You may notice a reduction in vehicle speed caused by reduced engine power in order to manage the engine coolant temperature. Your vehicle may enter this mode if certain high-temperature and high-load conditions take place. The amount of speed reduction depends on vehicle loading, grade and ambient temperature. If this occurs, there is no need to stop your vehicle. You can continue to drive.

The air conditioning may automatically turn on and off during severe operating conditions to protect the engine from overheating. When the coolant temperature decreases to the normal operating temperature, the air conditioning turns on.

If the coolant temperature gauge moves fully into the red zone, or if the coolant temperature warning or service engine soon messages appear in your information display, do the following:

1. Stop your vehicle as soon as it is safe to do so. Fully apply the parking brake, shift into park (P) or neutral (N).
2. Leave the engine running until the coolant temperature gauge needle returns to the normal position. If the temperature does not drop after several minutes, follow the remaining steps.
3. Switch the engine off and wait for it to cool. Check the coolant level.
4. If the coolant level is at or below the minimum mark, add prediluted coolant immediately.
5. If the coolant level is normal, restart the engine and continue.

## BRAKE FLUID CHECK



**WARNING:** Do not use any fluid other than the recommended brake fluid as this will reduce brake efficiency. Use of incorrect fluid could result in the loss of vehicle control, serious personal injury or death.



**WARNING:** Only use brake fluid from a sealed container. Contamination with dirt, water, petroleum products or other materials may result in brake system damage or failure. Failure to adhere to this warning could result in the loss of vehicle control, serious personal injury or death.



**WARNING:** Do not allow the fluid to touch your skin or eyes. If this happens, rinse the affected areas immediately with plenty of water and contact your physician.

# Maintenance



**WARNING:** A fluid level between the **MAX** and **MIN** lines is within the normal operating range and there is no need to add fluid. A fluid level not in the normal operating range could compromise the performance of the system. Have your vehicle checked immediately.



To avoid fluid contamination, the reservoir cap must remain in place and fully tight, unless you are adding fluid.

Only use fluid that meets Ford specifications. See **Capacities and Specifications** (page 476).

## CLUTCH FLUID CHECK - MANUAL TRANSMISSION

The clutch and brake systems share the same fluid reservoir. See **Brake Fluid Check** (page 427).

## CHANGING THE 12V BATTERY



**WARNING:** Batteries normally produce explosive gases which can cause personal injury. Therefore, do not allow flames, sparks or lighted substances to come near the battery. When working near the battery, always shield your face and protect your eyes. Always provide correct ventilation.



**WARNING:** When lifting a plastic-cased battery, excessive pressure on the end walls could cause acid to flow through the vent caps, resulting in personal injury and damage to the vehicle or battery. Lift the battery with a battery carrier or with your hands on opposite corners.



**WARNING:** Keep batteries out of reach of children. Batteries contain sulfuric acid. Avoid contact with skin, eyes or clothing. Shield your eyes when working near the battery to protect against possible splashing of acid solution. In case of acid contact with skin or eyes, flush immediately with water for a minimum of 15 minutes and get prompt medical attention. If acid is swallowed, call a physician immediately.



**WARNING:** Battery posts, terminals and related accessories contain lead and lead compounds. Wash hands after handling.



**WARNING:** For vehicles with Auto-Start-Stop the battery requirement is different. You must replace the battery with one of exactly the same specification.

The battery is in the engine compartment.



# Maintenance

---

Your vehicle has a maintenance-free battery. It does not require additional water during service.

If the vehicle battery has a cover, make sure you correctly install it after cleaning or replacing the battery.

For longer, trouble-free operation, keep the top of the battery clean and dry and the battery cables tightly fastened to the battery terminals. If any corrosion is present on the battery or terminals, remove the cables from the terminals and clean with a wire brush. You can neutralize the acid with a solution of baking soda and water.

We recommend that you disconnect the negative battery cable terminal from the battery if you plan to store your vehicle for an extended period.

**Note:** *If you only disconnect the negative battery cable terminal, make sure it is isolated or placed away from the battery terminal to avoid unintended connection or arcing.*

To maintain correct operation of the battery management system, if you add any electrical devices to your vehicle, do not connect the ground connection directly to the negative battery terminal. A connection at the negative battery terminal can cause inaccurate measurements of the battery condition and potential incorrect system operation.

**Note:** *If you add electrical accessories or components to your vehicle this may adversely affect battery performance, durability and the performance of other electrical systems on your vehicle.*

If you replace the battery make sure it matches the electrical requirements of your vehicle.

If you disconnect or replace the battery and your vehicle has an automatic transmission, it must relearn its adaptive strategy. Because of this, the transmission may shift firmly when first driven. This is normal operation while the transmission fully updates its operation to optimum shift feel.

## Remove and Reinstall the Battery

To disconnect or remove the battery, do the following:

1. Apply the parking brake and switch the ignition off.
2. Switch all electrical equipment off, for example lights and radio.
3. Wait a minimum of two minutes before disconnecting the battery.

**Note:** *The engine management system has a power hold function and remains powered for a period of time after you switch the ignition off. This is to allow diagnostic and adaptive tables to be stored. Disconnecting the battery without waiting can cause damage not covered by the vehicle Warranty.*

4. Disconnect the negative battery cable terminal.
5. Disconnect the positive battery cable terminal.
6. Remove the battery securing clamp.
7. Remove the battery.
8. To install, reverse the removal procedure.

**Note:** *Before reconnecting the battery, make sure the ignition remains switched off.*

**Note:** *Make sure the battery cable terminals are fully tightened.*

# Maintenance

If you disconnect or replace the vehicle battery, you must reset the following features:

- Window bounce-back. See **Resetting Window Bounce-Back** (page 127).
- Clock Settings.
- Pre-set radio stations.

## Battery Disposal



Make sure that you dispose of old batteries in an environmentally friendly way.

Seek advice from your local authority about recycling old batteries.

## WASHER FLUID CHECK

When adding fluid, use a mixture of washer fluid and water to help prevent freezing and improve the cleaning capability. For information on fluid dilution follow the manufacturer's instructions.

**Note:** *The reservoir supplies the front and rear washer systems.*

## CHECKING THE WIPER BLADES



Run the tip of your fingers over the edge of the blade to check for roughness.

Clean the wiper blades with washer fluid or water applied with a soft sponge or cloth.

## CHANGING THE FRONT WIPER BLADES

1. Fully lift the wiper arm.

**Note:** *Do not hold the wiper blade to lift the wiper arm.*

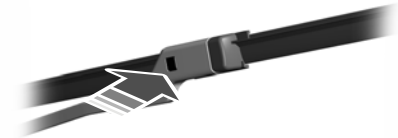

E264374

2. Press the wiper blade locking button.

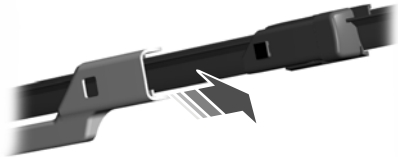

E264375

3. Remove the wiper blade.

**Note:** *Make sure that the wiper arm does not spring back against the glass when the wiper blade is not attached.*

4. To install, reverse the removal procedure.

**Note:** *Make sure that the wiper blade locks into place.*

## CHANGING THE REAR WIPER BLADES

1. Lift the wiper arm.

**Note:** *Do not hold the wiper blade to lift the wiper arm.*

# Maintenance

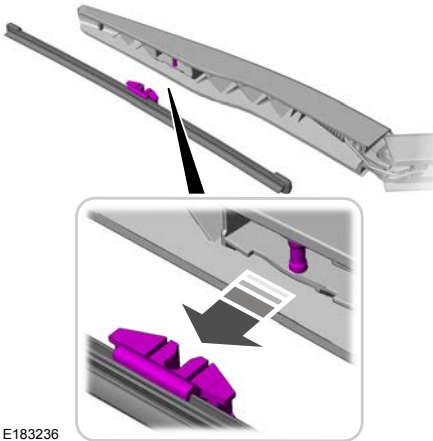

E183236

2. Disengage the wiper blade from the wiper arm.

**Note:** Make sure that the wiper arm does not spring back against the glass when the wiper blade is not attached.

3. To install, reverse the removal procedure.

**Note:** Make sure that the wiper blade locks into place.

## REMOVING A HEADLAMP



**WARNING:** Switch the lamps and the ignition off. Failure to do so could result in serious personal injury.



**WARNING:** Lamps and associated components become hot when in use. Let them cool down before you remove them.

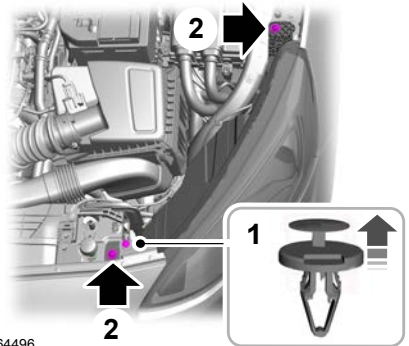

E264496

1. Use a suitable tool, for example a small flat blade screwdriver, to carefully raise the center pin and then remove the trim clip.
2. Remove the screws that secure the lamp assembly.

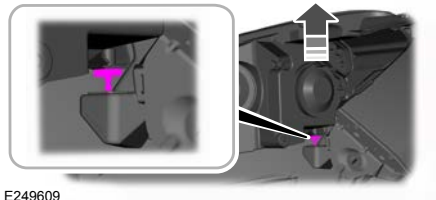

E249609

3. Carefully lift the rear of the headlamp up to disengage it from the lower fixing point.
4. Remove the headlamp.

**Note:** Take care when removing the lamp. There are rupture points adjacent to the headlamp securing screws that are designed to separate under impact.

5. Disconnect the electrical connector.
6. To install, reverse the removal procedure.

# Maintenance

## REMOVING A REAR LAMP - 5-DOOR/WAGON

**WARNING:** Lamps and associated components become hot when in use. Let them cool down before you remove them.

### Brake Lamp, Rear Lamp and Direction Indicator



E264497

1. Carefully remove the luggage compartment trim panel.

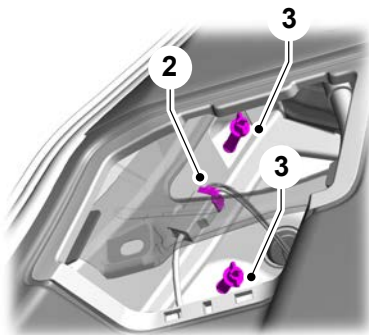

E264498

2. Disconnect the electrical connector.
3. Remove the wing nuts that secure the lamp assembly.
4. Remove the lamp.
5. To install, reverse the removal procedure.

### Reversing Lamp and Rear Lamp

1. Open the liftgate.

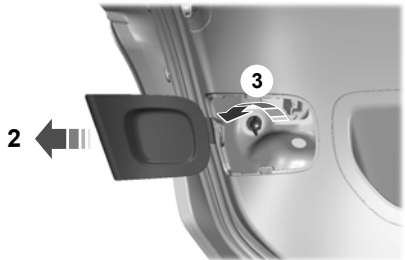

2. Carefully remove the cover.
3. Turn the wing nut counterclockwise and remove it.

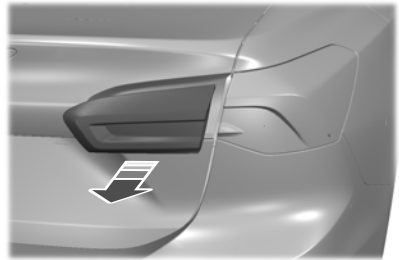

4. Remove the lamp.
5. Disconnect the electrical connector.
6. To install, reverse the removal procedure.

# Maintenance

## REMOVING A REAR LAMP - 4-DOOR



**WARNING:** Lamps and associated components become hot when in use. Let them cool down before you remove them.

### Brake Lamp, Rear Lamp and Direction Indicator

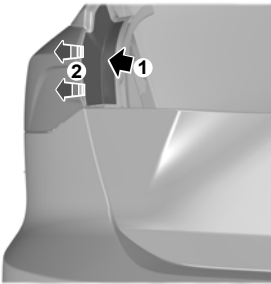

1. Press the panel as indicated.
2. Carefully remove the panel.

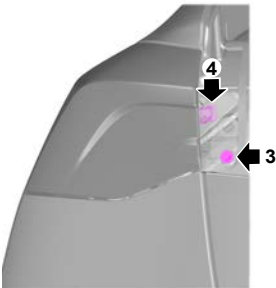

3. Remove the bolt that secures the lamp assembly.
4. Gently pull the lamp assembly away from the vehicle.
5. Disconnect the electrical connector.

6. To install, reverse the removal procedure.

### Reversing Lamp and Rear Lamp

1. Open the liftgate.

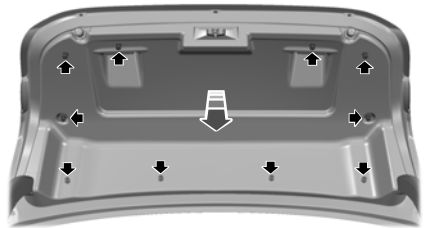

2. Firmly pull the soft trim panel at the ten fixing points to unclip the soft trim panel.

**Note:** Use a screwdriver to gently lift the panel.

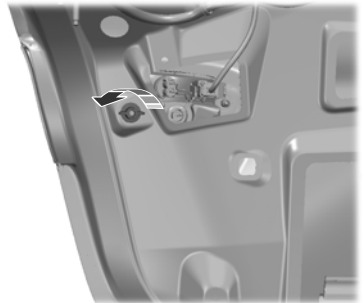

3. Turn the wing nut counterclockwise and remove it.

# Maintenance



4. Disconnect the electrical connector.

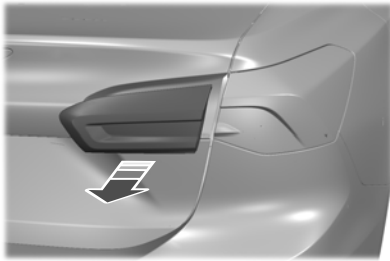

5. Remove the lamp.
6. To install, reverse the removal procedure.

## CHANGING A BULB

**WARNING:** Switch the lamps and the ignition off. Failure to do so could result in serious personal injury.

**WARNING:** Lamps and associated components become hot when in use. Let them cool down before you remove them.

Use the correct specification bulb. See **Bulb Specification Chart** (page 489).

## Headlamp

You may have to remove the headlamp assembly prior to replacing a bulb. See **Removing a Headlamp** (page 431).

## Halogen Headlamp

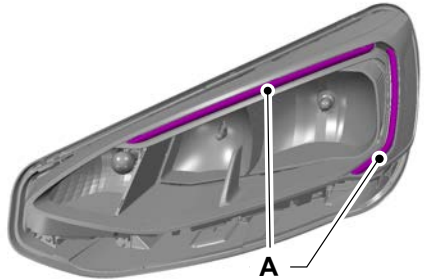

- A Daytime running lamps.

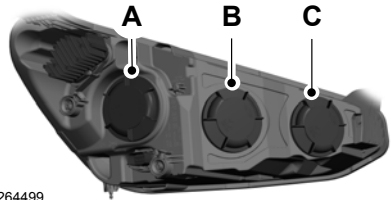

E264499

- A Headlamp low beam.  
B Headlamp high beam.  
C Front direction indicator.

## Headlamp Low Beam

1. Turn the cover counterclockwise and remove it.

# Maintenance

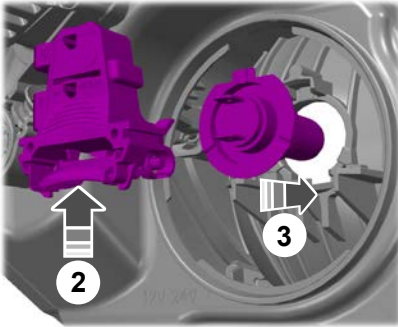

2. Press the clip to release the bulb holder.
3. Remove the bulb by pulling it straight out.
4. To install, reverse the removal procedure.

**Note:** Do not touch the bulb glass.

## Headlamp High Beam

1. Turn the cover counterclockwise and remove it.

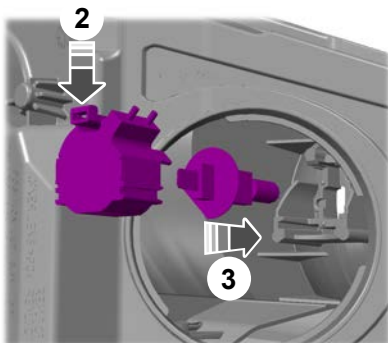

2. Press the clip to release the bulb holder.

3. Remove the bulb by pulling it straight out.
4. To install, reverse the removal procedure.

**Note:** Do not touch the bulb glass.

## Daytime Running Lamp

These lamps have LEDs.

**Note:** We recommend that you have LEDs changed by an authorized dealer.

## Front Direction Indicator

1. Turn the cover counterclockwise and remove it.

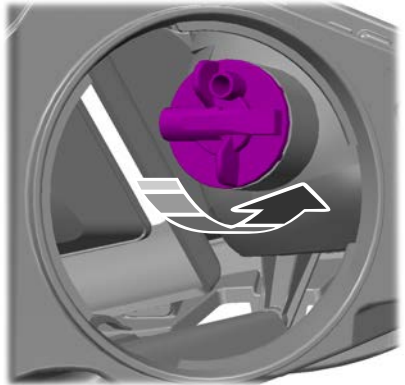

2. Turn the bulb holder counterclockwise and remove it.
3. Press the bulb in and turn the bulb counterclockwise to remove it.
4. To install, reverse the removal procedure.

# Maintenance

## LED Headlamp

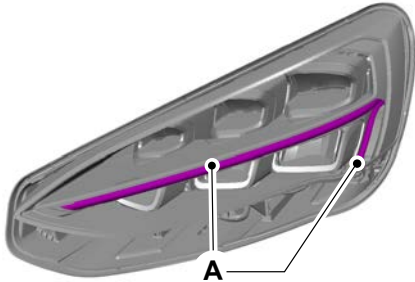

A Daytime running lamps.

These lamps have LEDs.

**Note:** We recommend that you have LEDs changed by an authorized dealer.

## Front Fog Lamp

1. Disconnect the electrical connector.



E236628

2. Turn the bulb holder counterclockwise to remove the bulb.

**Note:** You cannot separate the bulb from the bulb holder.

3. To install, reverse the removal procedure.

**Note:** Do not touch the bulb glass.

**Note:** Front fog lamps are also available as LED lamps.

**Note:** We recommend that you have LEDs changed by an authorized dealer.

## Rear Lamp

Remove the rear lamp assembly prior to replacing any bulb. See **Removing a Rear Lamp** (page 432). See **Removing a Rear Lamp** (page 433).

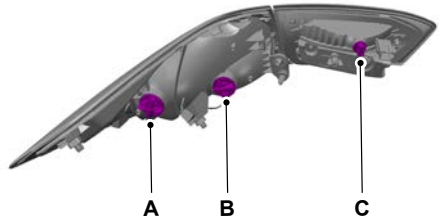

- A Stoplamp.
- B Rear direction indicator.
- C Rear lamp.



# Maintenance

## Stoplamp

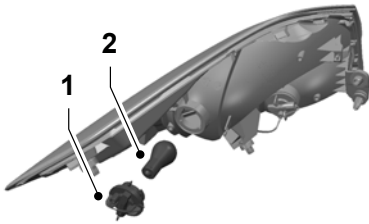

1. Turn the bulb holder counterclockwise and remove it.
2. Press the bulb in and turn the bulb counterclockwise to remove it.
3. To install, reverse the removal procedure.

## Rear Direction Indicator

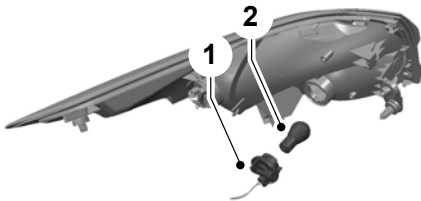

1. Turn the bulb holder counterclockwise and remove it.
2. Press the bulb in and turn the bulb counterclockwise to remove it.
3. To install, reverse the removal procedure.

## Rear Lamp

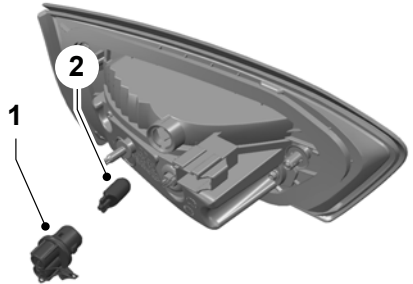

1. Turn the bulb holder counterclockwise and remove it.
2. Press the bulb in and turn the bulb counterclockwise to remove it.
3. To install, reverse the removal procedure.

**Note:** Rear lamps are also available as LED lamps.

**Note:** We recommend that you have LEDs changed by an authorized dealer.

## Reversing Lamp and Rear Fog Lamp

These lamps have LEDs.

**Note:** We recommend that you have LEDs changed by an authorized dealer.

## License Plate Lamp

These lamps have LEDs.

**Note:** We recommend that you have LEDs changed by an authorized dealer.

## High Mounted Stoplamp

These lamps have LEDs.

**Note:** We recommend that you have LEDs changed by an authorized dealer.

## **TRACK USE PRECAUTIONS**

Before using your vehicle on a track, check the engine oil level. See **Engine Oil Check** (page 421).

Maintain the engine oil level at or near the maximum mark on the engine oil dipstick when using your vehicle on a track.

# Launch Control - ST, Manual Transmission

---

## WHAT IS LAUNCH CONTROL

Launch control is an electronic driving aid that helps to deliver a fast acceleration when you pull away from a standstill.

## LAUNCH CONTROL PRECAUTIONS

Make sure that there are no pedestrians, objects or traffic in front of your vehicle.

## LAUNCH CONTROL LIMITATIONS

Launch control does not operate when the transmission is in reverse or if the engine has not reached normal operating temperature.

## SWITCHING LAUNCH CONTROL ON AND OFF

1. Press the menu button on the steering wheel to enter the information display main menu.
2. Select **Settings**.
3. Switch **Launch control** on or off.

**Note:** *The system remains on until you switch it off or you switch the ignition off.*

## USING LAUNCH CONTROL

1. Bring your vehicle to a stop with the wheels pointing straight ahead.
2. Switch **Launch control** on. See **Switching Launch Control On and Off** (page 439).
3. Fully press the clutch pedal and shift into first gear.
4. Fully press the accelerator pedal.

**Note:** *The system brings the engine to the optimum speed.*

5. Quickly and fully release the clutch pedal in a single movement.

## LAUNCH CONTROL INDICATORS

LC

Illuminates in the information bar when you switch the system on.

# Vehicle Care

---

## CLEANING THE EXTERIOR

### Cleaning the Exterior Precautions

Immediately remove fuel spillages, AdBlue residuals, bird droppings, insect deposits and road tar. These may cause damage to your vehicle's paintwork or trim over time.

Remove any exterior accessories, for example antennas, before entering a car wash.

### Cleaning Headlamps and Rear Lamps

We recommend that you only use cold or lukewarm water containing car shampoo to clean the headlamps and the rear lamps.

Do not scrape the lamps.

Do not wipe lamps when they are dry.

### Cleaning Windows and Wiper Blades

To clean the windshield and wiper blades:

- Clean the windshield with a non-abrasive glass cleaner.

**Note:** *When cleaning the interior of the windshield, avoid getting any glass cleaner on the instrument panel or door panels. Wipe any glass cleaner off these surfaces immediately.*

- Clean the wiper blades with washer fluid or water applied with a soft sponge or cloth.

**Note:** *Do not use razor blades or other sharp objects to clean or remove decals from the inside of the heated rear window. This can cause damage not covered by the vehicle Warranty.*

### Cleaning Chrome, Aluminium or Stainless Steel

We recommend that you only use a car shampoo, a soft cloth and water on bumpers and other chrome, aluminium or stainless steel parts.

**Note:** *For additional information and assistance, we recommend that you contact an authorized dealer.*

**Note:** *Rinse the area well after cleaning.*

**Note:** *Do not use abrasive materials, for example steel wool or plastic pads, as they can scratch these surfaces.*

**Note:** *Do not use chrome cleaner, metal cleaner or polish on wheels or wheel covers.*

### Cleaning Wheels

Only use a recommended wheel and tire cleaner to clean the wheels weekly. For additional information and assistance, we recommend that you contact an authorized dealer.

1. Use a sponge to remove heavy deposits of dirt and brake dust.
2. Rinse well after cleaning.

**Note:** *Do not apply a cleaning chemical to warm or hot wheel rims and covers.*

If you intend on parking your vehicle for an extended period after cleaning the wheels with a wheel cleaner, drive your vehicle for a few minutes before parking your vehicle. This reduces the risk of corrosion of the brake discs, brake pads and linings.

Do not clean the wheels when they are hot.

**Note:** *Some car washes could damage wheel rims and covers.*

**Note:** *Using non-recommended cleaners, harsh cleaning products, chrome wheel cleaners or abrasive materials could damage wheel rims and covers.*

# Vehicle Care

## Cleaning the Engine Compartment

Use a vacuum cleaner to remove debris from the screen area below windshield.

**Note:** *If you are not familiar with the parts around the engine do not wash the engine compartment. Avoid frequent engine washes.*

When washing the engine compartment:

- Never wash or rinse the engine while it is hot or running.
- Never wash or rinse any ignition coil, spark plug wire or spark plug well.
- Cover the battery, power distribution box, and air filter assembly to prevent water damage.

**Note:** *If your vehicle has an engine cover remove the cover before application of shampoo and degreaser.*

- Spray an approved engine shampoo and degreaser on all parts that require cleaning and rinse with water.

## Cleaning Stripes or Graphics

It is recommended to wash your vehicle by hand however, pressure washing may be used under the following conditions:

- Use a spray with a 40° wide spray angle pattern.
- Keep the nozzle at a 305 mm (12 in) distance and 90° angle to your vehicle's surface.
- Do not use water pressure higher than 14,000 kPa (2,000 psi).
- Do not use water hotter than 82°C (179°F).

**Note:** *Holding the pressure washer nozzle at an angle to the vehicle's surface may damage graphics and cause the edges to peel away from the vehicle's surface.*

## Cleaning Camera Lenses and Sensors

We recommend that you only use lukewarm or cold water and a soft cloth to clean the camera lens and sensors.

**Note:** *Do not pressure wash camera lens and sensors.*

## Cleaning the Underbody

Flush the complete underside of your vehicle frequently. Keep body and door drain holes free from packed dirt.

Rear suspension components may require regular cleaning with a power washer or a thorough rinse with a strong stream of water if the vehicle is operated in dusty or muddy environments. Rear leaf springs or other suspension components may emit squeaking or popping noises while operating the vehicle if particles, such as dirt, rocks, or other debris, are present in the components.

## CLEANING THE INTERIOR

### Cleaning the Instrument Panel



**WARNING:** Do not use chemical solvents or strong detergents when cleaning the steering wheel or instrument panel to avoid contamination of the airbag system.

We recommend that you only clean the instrument panel and cluster lens with a damp soft cloth. Dry the area with a clean, soft cloth.

For additional information and assistance, we recommend that you contact an authorized dealer.

# Vehicle Care

**Note:** Avoid cleaners or polishes that increase the gloss of the upper portion of the instrument panel. The dull finish in this area helps protect you from undesirable windshield reflection.

## Cleaning Plastic

We recommend that you only use a mild soap and water solution on a soft cloth. Dry the area with a clean, soft cloth.

## Cleaning Displays and Screens

We recommend that you only use a microfiber cloth in a circular motion to clean off the fingerprint or dust.

If dirt or fingerprints are still on the screen, apply a small amount of alcohol to the cloth and try to clean it again.

**Note:** Do not pour or spray alcohol onto the touchscreen.

**Note:** Do not use detergent or any type of solvent to clean the touchscreen.

## Cleaning Leather and Vinyl

We recommend that you only clean the leather and vinyl surfaces in the following way:

1. Remove dust and loose dirt with a vacuum cleaner.
2. Wipe the surface with a soft, damp cloth and a mild soap and water solution. Dry the area with a clean, soft cloth.
3. Make sure the leather is dry, then apply a small amount of conditioner to a clean, dry cloth.

4. Rub the conditioner into the leather until it disappears. Allow the conditioner to dry, then repeat the process for the entire interior. If a film appears, wipe it off with a dry, clean cloth.
5. For additional information and assistance, we recommend that you contact an authorized dealer.

## Cleaning Fabric Seats and Headliners



**WARNING:** On vehicles equipped with seat-mounted airbags, do not use chemical solvents or strong detergents. Such products could contaminate the side airbag system and affect performance of the side airbag in a crash.

We recommend that you only clean the fabric seats and headliners in the following way:

1. Remove dust and loose dirt with a vacuum cleaner.
2. Wipe the surface with a soft, damp cloth and a mild soap and water solution. Dry the area with a clean, soft cloth.
3. For additional information and assistance, we recommend that you contact an authorized dealer.

For heavy stains, spot clean the area. If a ring forms on the fabric, clean the entire area immediately, but do not oversaturate or the ring could set.

## Cleaning Carpets and Floor Mats

We recommend that you only clean your carpets in the following way:

1. Remove dust and loose dirt with a vacuum cleaner.

# Vehicle Care

2. Wipe the surface with a soft, damp cloth and a mild soap and water solution. Dry the area with a clean, soft cloth.
3. For additional information and assistance, we recommend that you contact an authorized dealer.

For heavy stains, spot clean the area. If a ring forms on the fabric, clean the entire area immediately, but do not oversaturate or the ring could set.

We recommend that you only clean your floor mats in the following way:

1. Remove dust and loose dirt with a vacuum cleaner.
2. Wash rubber floor mats using mild soap and lukewarm or cold water.
3. Completely dry the floor mat before placing them back in your vehicle.

## Cleaning Seatbelts



**WARNING:** Do not use cleaning solvents, bleach or dye on the vehicle's seatbelts, as these actions may weaken the belt webbing.

1. Wipe the surface with a soft, damp cloth and a mild soap and water solution. Dry the area with a clean, soft cloth.

## Cleaning Storage Compartments

1. Remove dust and loose dirt with a vacuum cleaner.
2. Wipe the surface with a soft, damp cloth and a mild soap and water solution. Dry the area with a clean, soft cloth.

## Cleaning Moonroof Tracks

1. Remove debris from the tracks with a vacuum cleaner.
2. Wipe the bulb seal and mating painted roof metal surface with a soft, damp cloth and a mild soap and water solution.

## REPAIRING MINOR PAINT DAMAGE

Authorized dealers have touch-up paint to match your vehicle's color. Your vehicle color code is printed on a sticker on the front, left-hand side door jamb. Take your color code to your authorized dealer to make sure you get the correct color.

Before repairing minor paint damage, use a cleaner to remove particles such as bird droppings, tree sap, insect deposits, tar spots, road salt and industrial fallout.

Read the instructions before using cleaning products.

## WAXING YOUR VEHICLE

Wax the high-gloss painted surface of your prewashed vehicle once or twice a year.

We recommend that you only use an approved quality wax that does not contain abrasives. Follow the manufacturer's instructions to apply and remove the wax. For additional information and assistance, we recommend that you contact an authorized dealer.

When washing and waxing, park your vehicle in a shaded area out of direct sunlight.

**Note:** Avoid waxing unpainted or low-gloss black colored parts, they discolor over time.

# Wheels and Tires

## GENERAL INFORMATION

The recommended tire inflation pressures are on the tire information label on the driver side B-pillar.

Check and set the tire pressure at the ambient temperature in which you are intending to drive your vehicle and when the tires are cold. See **Tire Pressures** (page 457).

**Note:** Check your tire pressures regularly to optimize fuel economy.

Only use approved wheel and tire sizes. Using other sizes could damage your vehicle and could make the National Type Approval invalid.

Installation of any tires that are not the original equipment tire size can cause the speedometer to display incorrect vehicle speed.

## TIRE SEALANT AND INFLATOR KIT



**WARNING:** Do not use the inflator kit on run flat tires. This could cause loss of vehicle control.



**WARNING:** Depending on the type and extent of tire damage, some tires can only be partially sealed or not sealed at all. Loss of tire pressure can affect vehicle handling, leading to loss of vehicle control.



**WARNING:** Do not use the kit on a previously damaged tire, for example when it has been driven under inflated. This could cause loss of vehicle control, personal injury or death.

If your vehicle does not have a spare wheel it has a tire sealant and inflator kit. The kit is in the luggage compartment. Only use the kit supplied with your vehicle.

**Note:** The kit can only temporarily repair one tire puncture with a maximum puncture size of up to 6 mm (0.24 in).

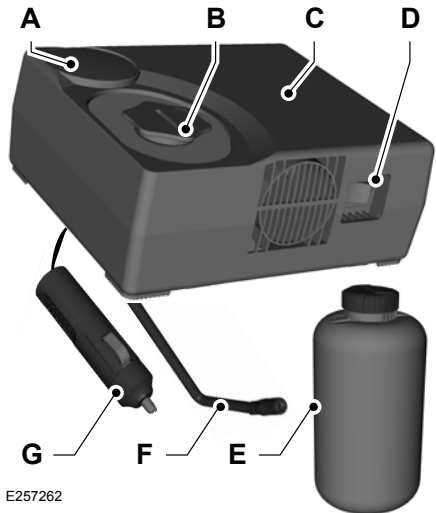

E257262

- A Pressure Gauge.
- B Sealant bottle access cap.
- C Warning label.
- D Power switch.
- E Sealant bottle.
- F Tire inflation pipe.
- G 12 volt DC power point connector.

**Note:** Make sure you regularly check the expiry date on the sealant bottle.



# Wheels and Tires



If the low tire pressure warning lamp illuminates do the following:

1. Gradually reduce the vehicle speed and stop your vehicle as soon as it is safe to do so.
2. Apply the parking brake and switch the ignition off.
3. Check for a punctured tire.

**Note:** Do not remove objects, for example nails or screws from a punctured tire.

## Using the Tire Sealant and Inflator Kit



**WARNING:** Check the sidewall of the tire prior to inflation. If there are any cracks, bumps or similar damage, do not attempt to inflate the tire. This could cause personal injury.



**WARNING:** Watch the sidewall of the tire when inflating. If any cracks, bumps or similar damage appears, switch the compressor off and let the air out by means of the pressure relief valve. Do not continue driving with this tire. This could cause loss of vehicle control.



**WARNING:** Do not stand directly beside the tire while the compressor is operating. This could cause personal injury if the tire bursts.



**WARNING:** Do not leave the kit unattended when it is in use. Failure to follow this instruction could result in personal injury or death.



**WARNING:** Do not keep the compressor operating for more than 10 minutes. This could cause the compressor to malfunction causing serious personal injury.

To temporarily repair a punctured tire, do the following:



E257263

1. Release the tire inflation pipe and the 12 volt DC power point connector from the underside of the compressor.

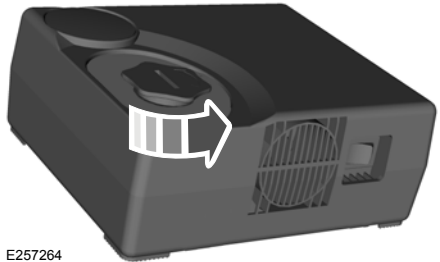

E257264

2. Turn the sealant bottle access cap counterclockwise and remove it.

# Wheels and Tires

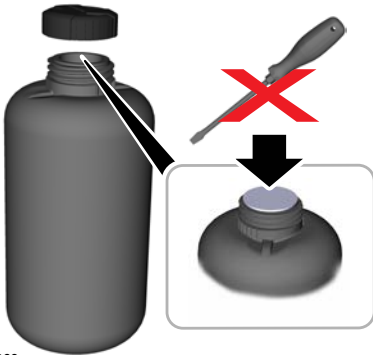

E256963

3. Remove the sealant bottle cap. Do not pierce or remove the seal.

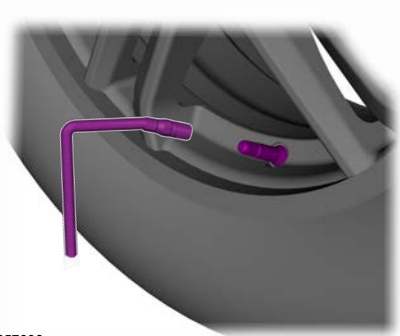

E257006

5. Remove the tire valve dust cap and attach the tire inflation pipe.

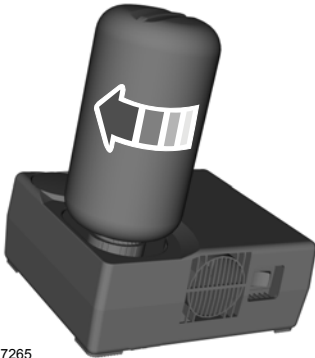

E257265

4. Attach the sealant bottle to the compressor. Turn the sealant bottle clockwise until you feel a strong resistance.



E257022

6. Plug the 12 volt DC power point connector into the 12 volt DC socket. See **Auxiliary Power Points** (page 188).
7. Start the engine.

**Note:** Attaching the sealant bottle to the compressor pierces the seal. Do not loosen the bottle as sealant could escape.

# Wheels and Tires

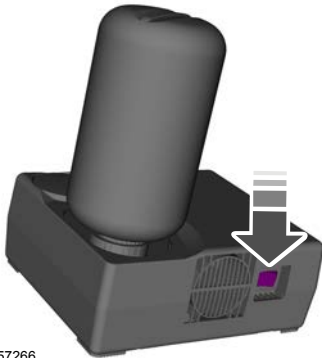

E257266

8. Switch the compressor on.



E257121

9. Inflate the tire to between 2–3 bar (29–44 psi).

**Note:** If the tire pressure does not reach 1.8 bar (26 psi) within 10 minutes, the tire could be damaged beyond a temporary repair. Have your vehicle immediately checked. Do not drive your vehicle.

10. When the tire reaches the recommended tire pressure of between 2–3 bar (29–44 psi), switch the compressor and the ignition off.

11. Disconnect the tire inflation pipe and the 12 volt DC power point connector.

**Note:** Do not remove the sealant bottle from the compressor.

12. Reinstall the tire valve dust cap.  
13. Place the warning label on the steering wheel and correctly stow the kit.



E257942

14. Immediately drive your vehicle for 3–10 km (2–6 mi). Do not exceed 80 km/h (50 mph).



E257121

# Wheels and Tires

15. After driving between 3–10 km (2–6 mi), stop your vehicle and recheck the tire pressure. See **Tire Pressures** (page 457).

**Note:** If the tire pressure has dropped to 1.8 bar (26 psi) or below, the tire could be damaged beyond a temporary repair. Have your vehicle immediately checked. Do not drive your vehicle.

**Note:** If the tire pressure has dropped but is still above 1.8 bar (26 psi), use the kit to inflate the tire again.

## After Using the Tire Sealant and Inflator Kit



**WARNING:** If you experience heavy vibrations, unsteady steering behavior or noises while driving, reduce your speed gradually and stop your vehicle as soon as it is safe to do so. Recheck the tire and its pressure. If the tire pressure is less than 1.3 bar (18.9 psi) or if there are any cracks, bumps or similar damage visible, do not continue driving with this tire. This could cause loss of vehicle control.

The kit only provides temporary mobility. Regulations concerning tire repair or replacement after using the kit could differ from country to country. We recommend you consult a tire specialist.

After using the kit:

- Do not drive your vehicle more than 200 km (124 mi) before repairing or replacing the punctured tire.
- Inform all other users of your vehicle that a tire was sealed using the kit. Make them aware of the special driving conditions that must be observed.

- Regularly check the tire pressure until the sealed tire is repaired or replaced by a tire specialist. Before the tire is removed from the rim, you must inform the tire specialist that the tire contains sealant.
- Take the kit to an authorized dealer to have the sealant bottle and the tire inflation pipe replaced.

## TIRE CARE

**Note:** Front tires shown on the left side of the diagram.

### Non-directional tires

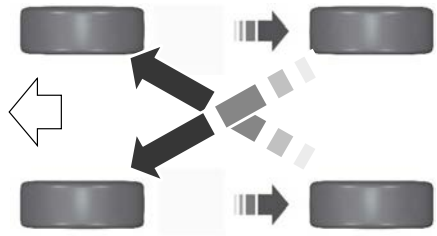

E142547

### Directional tires

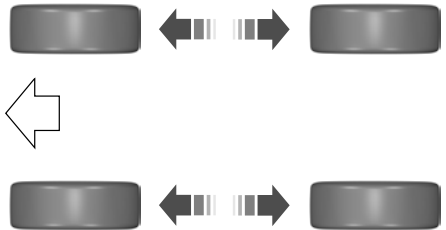

E70415

# Wheels and Tires

To make sure the front and rear tires of your vehicle wear evenly and last longer, we recommend that you swap the tires from front to rear and vice versa at regular intervals between 5,000 km (3,000 mi) and 10,000 km (6,000 mi).



**WARNING:** Do not scrub the sidewalls of the tires when you are parking.

If you have to mount a curb, do so slowly and approach it with the wheels at right-angles to the curb.

Examine the tires regularly for cuts, foreign objects and uneven wear of the tread. Uneven wear could mean that the wheel alignment is outside specification.

Check the tire pressures (including the spare) when cold, every two weeks.

## USING SUMMER TIRES

The original equipment tires on your vehicle are designed to optimize its performance in dry or wet summer road conditions. They are not designed for winter use. Do not use the summer tires with snow chains.

## USING WINTER TIRES



E278852

We recommend that you use winter or all-season tires carrying this symbol when the temperature is 7°C (45°F) or lower, or in snow and ice conditions.

Inflate the winter tires to the same tire pressures as those listed in the tire pressures table. See **Tire Pressures** (page 457).



**WARNING:** Snow tires must be the same size, load index and speed rating as those originally provided by Ford. Use of any tire or wheel not recommended by Ford can affect the safety and performance of your vehicle, which could result in an increased risk of loss of control, vehicle rollover, personal injury and death. Additionally, the use of non-recommended tires and wheels can cause steering, suspension, axle, transfer case or power transfer unit failure. Follow the Ford recommended tire inflation pressure found on the Safety Compliance Certification Label (on the door hinge pillar, door latch post or the door edge that meets the door latch post, next to the driver seat), or Tire Label on the B-Pillar or the edge of the driver door. Failure to follow the tire pressure recommendations can cause uneven treadwear patterns and adversely affect the way your vehicle handles.

## USING SNOW CHAINS - EXCLUDING: ACTIVE/ST



**WARNING:** Do not exceed 50 km/h (30 mph). Failure to follow this instruction could result in the loss of control of your vehicle, personal injury or death.

# Wheels and Tires

 **WARNING:** Do not use snow chains on snow-free roads.

 **WARNING:** Only fit snow chains to specified tires.

 **WARNING:** If your vehicle is fitted with wheel trims, remove them before fitting snow chains.

Only use snow chains on the front wheels.

Only use snow chains on the following specified tire sizes:

- 195/65R16.
  - Do not use snow chains greater than 7 mm (0.3 in).
- 205/60R16.
  - Do not use snow chains greater than 10 mm (0.4 in).
  - Do not use snow chains greater than 8 mm (0.3 in) for five spoke steel wheels.

Maintain correct tire pressures. See **Tire Pressures** (page 457).

## Vehicles with Stability Control

When stability control is on, your vehicle may exhibit some unusual driving characteristics. To reduce this, switch traction control off. See **Using Stability Control** (page 255).

**Note:** *The anti-lock brake system continues to correctly operate.*

## USING SNOW CHAINS - ACTIVE

 **WARNING:** Do not exceed 50 km/h (30 mph). Failure to follow this instruction could result in the loss of control of your vehicle, personal injury or death.

 **WARNING:** Do not use snow chains on snow-free roads.

 **WARNING:** Only fit snow chains to specified tires.

 **WARNING:** If your vehicle is fitted with wheel trims, remove them before fitting snow chains.

Only use snow chains on the front wheels.

Only use snow chains on the following specified tire sizes:

- 215/55R17.
  - Do not use snow chains greater than 10 mm (0.4 in).

Maintain correct tire pressures. See **Tire Pressures** (page 457).

## Vehicles with Stability Control

When stability control is on, your vehicle may exhibit some unusual driving characteristics. To reduce this, switch traction control off. See **Using Stability Control** (page 255).

**Note:** *The anti-lock brake system continues to correctly operate.*

# Wheels and Tires

## USING SNOW CHAINS - ST

 **WARNING:** Do not exceed 50 km/h (30 mph). Failure to follow this instruction could result in the loss of control of your vehicle, personal injury or death.

 **WARNING:** Do not use snow chains on snow-free roads.

 **WARNING:** Only fit snow chains to specified tires.

 **WARNING:** If your vehicle is fitted with wheel trims, remove them before fitting snow chains.

Only use snow chains on the front wheels.

Only use snow chains on the following specified tire sizes:

- 215/50R17.
  - Do not use snow chains greater than 7 mm (0.3 in).

Maintain correct tire pressures. See **Tire Pressures** (page 457).

### Vehicles with Stability Control

When stability control is on, your vehicle may exhibit some unusual driving characteristics. To reduce this, switch traction control off. See **Using Stability Control** (page 255).

**Note:** *The anti-lock brake system continues to correctly operate.*

## CHANGING A ROAD WHEEL

 **WARNING:** Do not fit more than one spare wheel on your vehicle at any one time.

 **WARNING:** Do not carry out any tire repairs on a spare wheel.

 **WARNING:** Do not switch off stability control or select sport mode, when using a temporary spare wheel or after inflating a tire using the temporary mobility kit.

If a tire deflates when your vehicle is moving, do the following:

- Firmly hold the steering wheel.
- Avoid heavy braking.
- Gradually reduce the vehicle speed and stop your vehicle as soon as it is safe to do so.
- Fully apply the parking brake.
- Switch the ignition off.

The spare wheel, vehicle jack, towing eye, lug nut tool and wheel trim remover are in the luggage compartment under the floor covering or in the side panel.

If the spare wheel is exactly the same type and size as the other fitted road wheels, you can replace the existing road wheel with the spare wheel and continue to drive in the normal manner. We recommend that you have the damaged road wheel and tire repaired or replaced as soon as possible.

### Dissimilar Spare Wheel and Tire Assembly Information

 **WARNING:** Failure to follow these guidelines could result in an increased risk of loss of vehicle control, injury or death.

 **WARNING:** If you are not sure what type of spare wheel your vehicle has, do not exceed 80 km/h (50 mph).

# Wheels and Tires

---

If the spare wheel is different to the other fitted road wheels, it may have a warning label with the appropriate maximum speed limit. Drive cautiously when using a dissimilar spare wheel and tire assembly.

A dissimilar spare wheel and tire is for temporary use only. Drive the shortest distance possible and have the damaged road wheel and tire repaired or replaced as soon as possible. If the dissimilar spare wheel or tire is damaged, it must be replaced.

If you use a dissimilar spare wheel and tire assembly, this can lead to impairment of the following:

- Handling, stability and braking performance.
- Comfort and noise.
- Ground clearance and parking at curbs.
- Winter weather driving capability.
- Wet weather driving capability.
- All-wheel driving capability.

A dissimilar spare wheel and tire assembly is different in size and appearance from the road wheels and tires and can be one of three types:

## **T-type Mini-spare Wheel**

The spare tire has the letter T preceding the tire size, for example T125/80R15 and may have Temporary Use Only molded in the sidewall.

When driving with this type of a dissimilar spare wheel:

- Do not exceed the maximum speed shown on the label.
- Do not load your vehicle beyond maximum vehicle load rating listed on the safety compliance label.
- Do not tow a trailer.

- Do not use snow chains on the end of your vehicle with the dissimilar spare tire.
- Do not use more than one dissimilar spare tire at a time.
- Do not use commercial car washing equipment.

## **Full-size Dissimilar Spare Wheel With a Label on the Wheel**

The label on the wheel states: THIS WHEEL AND TIRE ASSEMBLY FOR TEMPORARY USE ONLY.

When driving with this type of a dissimilar spare wheel:

- Do not exceed the maximum speed shown on the label.
- Do not load your vehicle beyond maximum vehicle load rating listed on the safety compliance label.
- Do not tow a trailer.
- Do not use snow chains on the end of your vehicle with the dissimilar spare tire.
- Do not use more than one dissimilar spare tire at a time.
- Do not use commercial car washing equipment.

## **Full-size Dissimilar Spare Wheel Without a Label on the Wheel**

If the spare wheel is exactly the same type and size as the other fitted road wheels, you can replace the existing road wheel with the spare wheel and continue to drive in the normal manner.



# Wheels and Tires

## Removing the Spare Wheel, Vehicle Jack and Lug Nut Tool

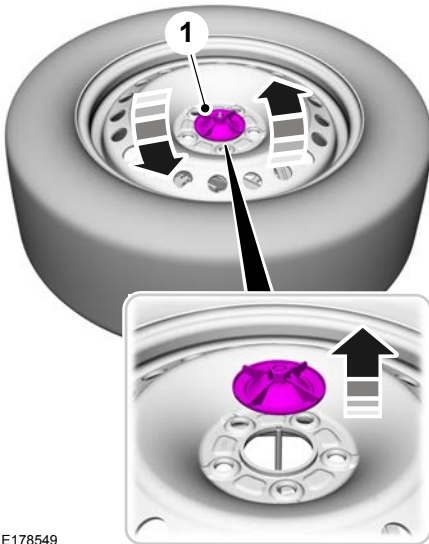

E178549

1. Turn the securing nut counterclockwise and remove it. Remove the wheel from the spare wheel well.

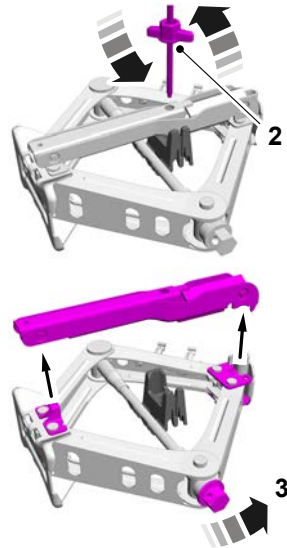

E178548

2. Turn the vehicle jack securing bolt counterclockwise and remove it.
3. Turn the vehicle jack screw counterclockwise to remove the vehicle jack handle and lug nut tool from the vehicle jack.

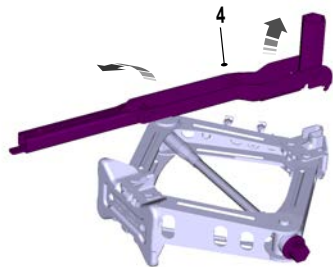

E245204

# Wheels and Tires

4. Unfold the vehicle jack handle and the hexagonal end into the correct position prior to use. Use the hexagonal end to operate the vehicle jack screw and to remove the lug nuts.

## Assembling the Lug Nut Tool

Fully unfold the vehicle jack handle and lug nut tool.

## Vehicles Without a Spare Wheel

Vehicles without a spare wheel have a temporary mobility kit. See **Tire Sealant and Inflator Kit** (page 444).

## Removing the Wheel Trim (If Equipped)

Use the hook on the vehicle jack handle and lug nut tool to remove the wheel trim.

**Note:** Make sure that you pull the wheel trim remover at right angles to the trim.

## Vehicle Jack

 **WARNING:** Check that the vehicle jack is not damaged or deformed and the thread is lubricated and clean.

 **WARNING:** Never place anything between the vehicle jack and the ground.

 **WARNING:** Never place anything between the vehicle jack and your vehicle.

 **WARNING:** Use a jack with a minimum lifting capacity of 1,500 kg (3,307 lb) and a lifting plate with a minimum diameter of 80 mm (3.1 in).

 **WARNING:** The jack supplied with this vehicle is only intended for changing wheels. Do not use the vehicle jack other than when you are changing a wheel in an emergency.

 **WARNING:** Do not work on your vehicle when the jack is the only support as your vehicle could slip off the jack. Failure to follow this instruction could result in personal injury or death.

 **WARNING:** No person should place any portion of their body under a vehicle that is supported by a jack.

 **WARNING:** Do not get under a vehicle that is only supported by a vehicle jack.

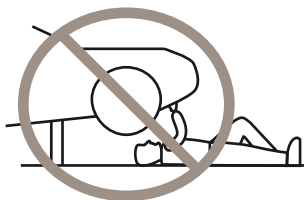

## Workshop Type Hydraulic Trolley Jack

 **WARNING:** Use a jack with a minimum lifting capacity of 1,500 kg (3,307 lb) and a lifting plate with a minimum diameter of 80 mm (3.1 in).

We recommend you use a workshop type hydraulic trolley jack for changing between summer and winter tires.

# Wheels and Tires



E93020

Refer to vehicle jack manufacturer's instructions.

## Vehicle Jacking Points



**WARNING:** Use only the specified jacking points. If you use other positions, you may damage the body, steering, suspension, engine, braking system or the fuel lines.



E269166

1. Locate the vehicle jacking points. Small arrow-shaped marks indicate the locations.

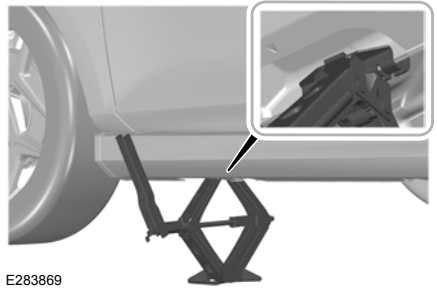

E283869

2. Carefully position the vehicle jack onto the vehicle jacking point.
3. Place the hexagonal end of the vehicle jack handle and lug tool onto the vehicle jack.
4. Turn the vehicle jack handle clockwise to raise the vehicle.

## Removing a Road Wheel



**WARNING:** Park your vehicle in such a position that neither the traffic nor you are hindered or endangered.



**WARNING:** Park your vehicle so that you do not obstruct the flow of traffic or place yourself in any danger and set up a warning triangle.



**WARNING:** Make sure that your vehicle is on firm and level ground with the front wheels pointing straight ahead.



**WARNING:** Switch the ignition off and apply the parking brake.



**WARNING:** If your vehicle has a manual transmission, shift into first or reverse gear. If your vehicle has an automatic transmission, shift into park (P).

# Wheels and Tires



**WARNING:** Make sure all passengers are out of your vehicle.



**WARNING:** Make sure that the vehicle jack is vertical to the jacking point and the base is flat on the ground.



**WARNING:** Secure the diagonally opposite wheel with an appropriate block or wheel chock.

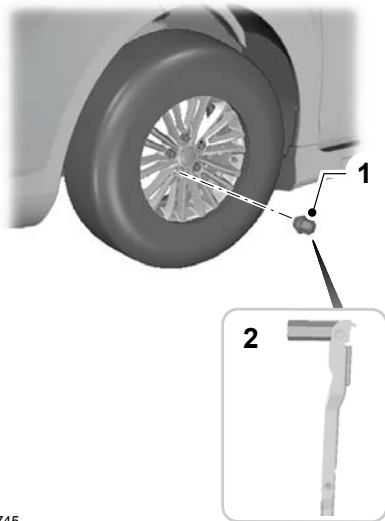

E181745

1. If your vehicle has locking lug nuts, install the locking lug nut tool and loosen the locking lug nut first.
2. Loosen the lug nuts.
3. Raise your vehicle until the tire is clear of the ground.
4. Remove the lug nuts and the wheel.

**Note:** Do not lay alloy wheels face down on the ground. This may damage the paint.

## Installing a Road Wheel



**WARNING:** When you install a wheel, always remove any corrosion, dirt or foreign materials present on the mounting surfaces of the wheel or the surface of the wheel hub, brake drum or brake disc that contacts the wheel. Make sure to secure any fasteners that attach the rotor to the hub so they do not interfere with the mounting surfaces of the wheel. Installing wheels without correct metal-to-metal contact at the wheel mounting surfaces can cause the wheel nuts to loosen and the wheel to come off while your vehicle is in motion, resulting in loss of vehicle control, personal injury or death.



**WARNING:** Make sure there is no grease or oil on the threads or the surface between the wheel lugs and nuts. This can cause the lug nuts to loosen while driving.



**WARNING:** Use only approved wheel and tire sizes. Using other sizes could damage your vehicle and will make the National Type Approval invalid.



**WARNING:** Do not fit run flat tires on vehicles that were not originally fitted with them. Contact an authorized dealer for more details about compatibility.



**WARNING:** Do not install alloy wheels using lug nuts designed for use with steel wheels.



**WARNING:** Have the lug nuts checked for tightness and the tire pressure checked as soon as possible.

# Wheels and Tires



1. Inspect the wheel pilot bore (**A**) and mounting surface prior to installation. Remove any visible corrosion or loose particles.
2. Install the wheel.
3. Install the lug nuts finger tight.

**Note:** Make sure that the cones on the lug nuts are against the wheel.

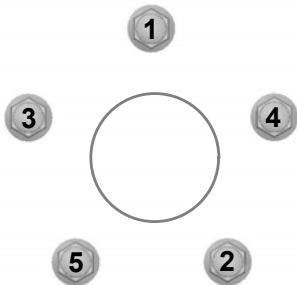

E75442

4. Partially tighten the lug nuts in the sequence shown.
5. Lower your vehicle and remove the vehicle jack.
6. Fully tighten the lug nuts in the sequence shown. See **Lug Nuts** (page 462).

7. Carefully install the wheel trim.

## TIRE PRESSURES - EXCLUDING: ACTIVE/ST

The recommended tire inflation pressures are on the tire information label on the driver side B-pillar.

Check all tire pressures when they are cold, at least once every two weeks.

**Note:** You may need to remove the spare wheel from the spare wheel well to check the tire pressure.

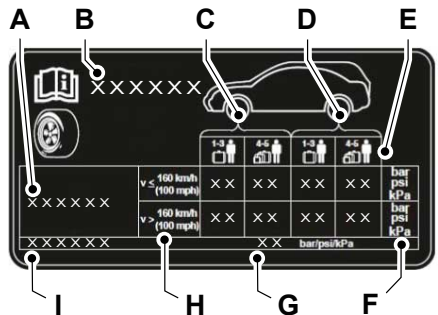

E254054

- A Tire size.
- B Vehicle model.
- C Front tire pressure.
- D Rear tire pressure.
- E Vehicle load.
- F Measure unit.
- G Spare wheel tire pressure.
- H Intended constant vehicle speed.
- I Spare wheel tire size.

# Wheels and Tires

## Up to 160 km/h (100 mph)

Tire Size	Normal Load		Full Load	
	Front	Rear	Front	Rear
	bar (psi)	bar (psi)	bar (psi)	bar (psi)
205/60R16	2.6 (38)	2.6 (38)	2.6 (38)	3.1 (45)
215/50R17	2.3 (33)	2.3 (33)	2.5 (36)	2.8 (41)
235/40R18	2.3 (33)	2.1 (30)	2.5 (36)	2.8 (41)

## Continuous Speed in Excess of 160 km/h (100 mph) or With Trailer Towing up to 100 km/h (62 mph)

Tire Size	Normal Load		Full Load	
	Front	Rear	Front	Rear
	bar (psi)	bar (psi)	bar (psi)	bar (psi)
205/60R16	2.6 (38)	2.6 (38)	2.6 (38)	3.1 (45)
215/50R17	2.3 (33)	2.3 (33)	2.6 (38)	2.9 (42)
235/40R18	2.3 (33)	2.1 (30)	2.5 (36)	2.9 (42)

## Temporary Spare Wheel (If Equipped)



**WARNING:** Do not switch off stability control or select sport mode, when using a temporary spare wheel or after inflating a tire using the temporary mobility kit.

Tire Size	bar (psi)
T125/70R16	4.2 (60)
T125/80R16	4.2 (60)

Do not exceed the maximum speed stated on the label attached to the temporary spare wheel.

# Wheels and Tires

## TIRE PRESSURES - ACTIVE

The recommended tire inflation pressures are on the tire information label on the driver side B-pillar.

Check all tire pressures when they are cold, at least once every two weeks.

**Note:** You may need to remove the spare wheel from the spare wheel well to check the tire pressure.

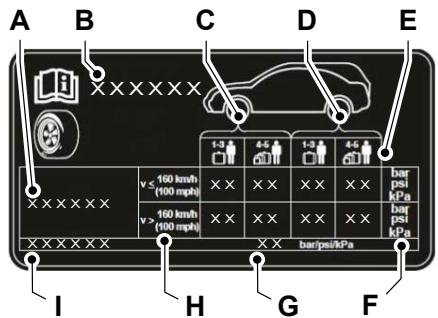

E254054

- A Tire size.
- B Vehicle model.
- C Front tire pressure.
- D Rear tire pressure.
- E Vehicle load.
- F Measure unit.
- G Spare wheel tire pressure.
- H Intended constant vehicle speed.
- I Spare wheel tire size.

## Up to 160 km/h (100 mph)

Tire Size	Normal Load		Full Load	
	Front	Rear	Front	Rear
	bar (psi)	bar (psi)	bar (psi)	bar (psi)
215/55R17	2.3 (33)	2.3 (33)	2.4 (35)	2.8 (41)
215/50R18	2.3 (33)	2.3 (33)	2.5 (36)	2.8 (41)

# Wheels and Tires

## Continuous Speed in Excess of 160 km/h (100 mph) or With Trailer Towing up to 100 km/h (62 mph)

Tire Size	Normal Load		Full Load	
	Front	Rear	Front	Rear
	bar (psi)	bar (psi)	bar (psi)	bar (psi)
215/55R17	2.3 (33)	2.3 (33)	2.4 (35)	2.8 (41)
215/50R18	2.3 (33)	2.3 (33)	2.5 (36)	2.8 (41)

## Temporary Spare Wheel (If Equipped)



**WARNING:** Do not switch off stability control or select sport mode, when using a temporary spare wheel or after inflating a tire using the temporary mobility kit.

Tire Size	bar (psi)
T125/70R16	4.2 (60)
T125/80R16	4.2 (60)

Do not exceed the maximum speed stated on the label attached to the temporary spare wheel.

## TIRE PRESSURES - ST

The recommended tire inflation pressures are on the tire information label on the driver side B-pillar.

Check all tire pressures when they are cold, at least once every two weeks.

**Note:** You may need to remove the spare wheel from the spare wheel well to check the tire pressure.



# Wheels and Tires

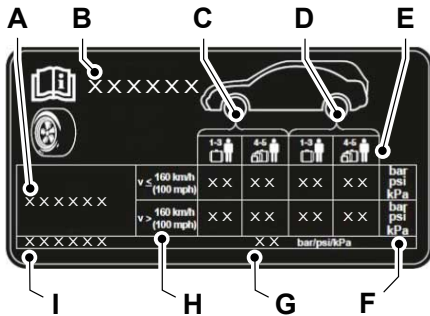

- A Tire size.
- B Vehicle model.
- C Front tire pressure.
- D Rear tire pressure.
- E Vehicle load.
- F Measure unit.
- G Spare wheel tire pressure.
- H Intended constant vehicle speed.
- I Spare wheel tire size.

E254054

## Up to 160 km/h (100 mph)

Tire Size	Normal Load		Full Load	
	Front	Rear	Front	Rear
	bar (psi)	bar (psi)	bar (psi)	bar (psi)
215/50R17	2.3 (33)	2.3 (33)	2.4 (35)	2.4 (35)
235/40R18	2.4 (35)	2.4 (35)	2.4 (35)	2.4 (35)
235/35R19	2.4 (35)	2.4 (35)	2.7 (39)	2.7 (39)

## Continuous Speed in Excess of 160 km/h (100 mph) or With Trailer Towing up to 100 km/h (62 mph)

Tire Size	Normal Load		Full Load	
	Front	Rear	Front	Rear
	bar (psi)	bar (psi)	bar (psi)	bar (psi)
215/50R17	2.7 (39)	2.4 (35)	2.9 (42)	3 (44)
235/40R18	2.4 (35)	2.4 (35)	2.5 (36)	2.6 (38)
235/35R19	2.7 (39)	2.4 (35)	2.9 (42)	3 (44)

# Wheels and Tires

## Temporary Spare Wheel (If Equipped)



**WARNING:** Do not switch off stability control or select sport mode, when using a temporary spare wheel or after inflating a tire using the temporary mobility kit.

Tire Size	bar (psi)
T125/70R17	4.2 (60)

Do not exceed the maximum speed stated on the label attached to the temporary spare wheel.

## LUG NUTS

### Lug Nut Torque

Nm ( lb.ft)
135 (100)

### Locking Lug Nuts

You can obtain a replacement locking lug nut key and replacement locking lug nuts from an authorized dealer using the reference number certificate.

# Tire Pressure Monitoring System (If Equipped)

## WHAT IS THE TIRE PRESSURE MONITORING SYSTEM



The tire pressure monitoring system measures the vehicle's tire pressures. A warning lamp illuminates if one or more tires are significantly underinflated or if there is a system malfunction.

## TIRE PRESSURE MONITORING SYSTEM PRECAUTIONS



**WARNING:** The tire pressure monitoring system is not a substitute for manually checking tire pressures. You should periodically check tire pressures using a pressure gauge. Failure to correctly maintain tire pressures could increase the risk of tire failure, loss of control, vehicle rollover and personal injury.



**WARNING:** Do not use the tire pressure displayed in the information display as a tire pressure gauge. Failure to follow this instruction could result in personal injury or death.

**Note:** The use of tire sealants can damage the tire pressure monitoring system.

## TIRE PRESSURE MONITORING SYSTEM LIMITATIONS

The warning lamp can illuminate when:

- You use a spare wheel or a tire sealant and inflator kit.
- The outside air temperature drops significantly. The tire pressure could decrease and activate the low tire pressure warning lamp. Check each tire to verify that none are flat. Inflate the tires, if needed, to the recommended pressures and carry out the reset procedure.

**Note:** Regularly checking the vehicle tire pressures can reduce the possibility for the warning lamp to illuminate due to outside air temperature changes.

**Note:** After you inflate the tires to the correct pressure, it may take up to two minutes of driving over 32 km/h (20 mph) for the warning lamp to turn off.

## VIEWING THE TIRE PRESSURES - VEHICLES WITH: 4.2 INCH INSTRUMENT CLUSTER DISPLAY SCREEN

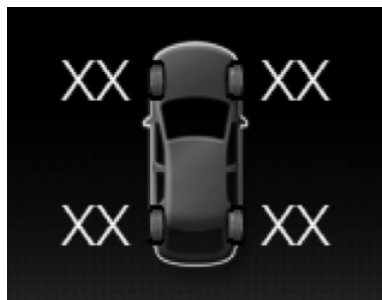

1. Using the information display controls on the steering wheel, select **Settings**.

# Tire Pressure Monitoring System (If Equipped)

2. Select **Information**.
3. Select **Tyre pressure**.

## VIEWING THE TIRE PRESSURES - VEHICLES WITH: 12.3 INCH INSTRUMENT CLUSTER DISPLAY SCREEN



1. Press the menu button on the steering wheel to enter the information display main menu.
2. Select **Select screens**.
3. Select **Tyre pressure**.

## RESETTING TIRE PRESSURE MONITORING SYSTEM - VEHICLES WITH: 4.2 INCH INSTRUMENT CLUSTER DISPLAY SCREEN

You must reset the tire pressure monitoring system after each tire replacement, tire rotation or after inflating the tires to the correct tire pressure.

**Note:** *If you have a new sensor or have rotated the vehicle tires, park your vehicle for at least 20 minutes, before resetting the system.*

**Note:** *The tire pressure monitoring system automatically re-learns the tire pressure sensors the next time you drive your vehicle for approximately 15 minutes.*

1. Using the information display controls on the steering wheel, select **Settings**.
2. Select **Information**.
3. Select **Tyre pressure**.
4. Select **Reset**.
5. Press and hold the **OK** button until the system reset confirmation appears.

## RESETTING TIRE PRESSURE MONITORING SYSTEM - VEHICLES WITH: 12.3 INCH INSTRUMENT CLUSTER DISPLAY SCREEN

You must reset the tire pressure monitoring system after each tire replacement, tire rotation or after inflating the tires to the correct tire pressure.

**Note:** *If you have a new sensor or have rotated the vehicle tires, park your vehicle for at least 20 minutes, before resetting the system.*

**Note:** *The tire pressure monitoring system automatically re-learns the tire pressure sensors the next time you drive your vehicle for approximately 15 minutes.*

1. Press the menu button on the steering wheel to enter the information display main menu.
2. Select **Settings**.
3. Select **Vehicle**.
4. Select **Tyre pressure**.
5. Press and hold the **OK** button until the system reset confirmation appears.

# Tire Pressure Monitoring System (If Equipped)

## TIRE PRESSURE MONITORING SYSTEM – TROUBLESHOOTING

### Tire Pressure Monitoring System – Warning Lamps



The low tire pressure warning lamp combines functions.

Warning Lamp	Possible Cause	Action
Solid warning lamp	One or more tires are significantly underinflated	Inflate the tires to the recommended tire pressure. See <b>Tire Pressures</b> (page 457). Check the tires for damage and repair them if necessary. Carry out the system reset procedure.
Solid warning lamp or flashing warning lamp	Temporary spare wheel in use	Repair the damaged road wheel and tire and refit it to your vehicle to restore the correct operation of the system.
	Tire pressure monitoring system malfunction	If the tires are inflated to the recommended tire pressures and the temporary spare wheel is not in use, the system has detected a fault that requires service. Have your vehicle checked as soon as possible.

## Tire Pressure Monitoring System (If Equipped)

---

### Tire Pressure Monitoring System – Information Messages

<b>Message</b>	<b>Action</b>
Tyre pressure low	Inflate the tires to the recommended tire pressure. Check the tires for damage and repair them if necessary. Carry out the system reset procedure.
Tyre pressure monitor malfunction	The system has detected a fault that requires service. Have your vehicle checked as soon as possible.
Tyre pressure sensor malfunction	The temporary spare wheel is either in use or the system has detected a fault in the sensor that requires service. Have your vehicle checked as soon as possible.

# Capacities and Specifications

---

## VEHICLE DIMENSIONS

<b>Dimension Description</b>	<b>Dimension mm (in)</b>
Overall length.	4,693 (184.8)
Overall width including the exterior mirrors.	1,979 (77.9)
Overall height including the roof rails.	1,521–1,545 (59.9–60.8)
Wheelbase.	2,700 (106.3)
Front track.	1,561–1,581 (61.5–62.2)
Rear track.	1,556–1,576 (61.3–62.0)

# Capacities and Specifications

---

## VEHICLE DIMENSIONS - 5-DOOR/ACTIVE

<b>Dimension Description</b>	<b>Dimension mm (in)</b>
Overall length.	4,397 (173.1)
Overall width including the exterior mirrors.	1,979 (77.9)
Overall height including the roof rails.	1,492–1,515 (58.7–59.6)
Wheelbase.	2,700 (106.3)
Front track.	1,561–1,581 (61.5–62.2)
Rear track.	1,543–1,576 (60.7–62.0)



# Capacities and Specifications

---

## VEHICLE DIMENSIONS - 5-DOOR, EXCLUDING: ACTIVE

<b>Dimension Description</b>	<b>Dimension mm (in)</b>
Overall length.	4,378–4,388 (172.4–172.8)
Overall width including the exterior mirrors.	1,979 (77.9)
Overall height excluding the antenna.	1,438–1,452 (56.6–57.2)
Wheelbase.	2,700 (106.3)
Front track.	1,561–1,581 (61.5–62.2)
Rear track.	1,543–1,576 (60.7–62.0)

# Capacities and Specifications

---

## VEHICLE DIMENSIONS - EXCLUDING: ACTIVE

<b>Dimension Description</b>	<b>Dimension mm (in)</b>
Overall length.	4,667–4,672 (183.7–183.9)
Overall width including the exterior mirrors.	1,979 (77.9)
Overall height excluding the antenna.	1,468–1,477 (57.8–58.1)
Wheelbase.	2,700 (106.3)
Front track.	1,561–1,581 (61.5–62.2)
Rear track.	1,556–1,576 (61.3–62.0)

# Capacities and Specifications

---

## VEHICLE DIMENSIONS - 4-DOOR

<b>Dimension Description</b>	<b>Dimension mm (in)</b>
Overall length.	4,647–4,654 (183.0–183.2)
Overall width including the exterior mirrors.	1,979 (77.9)
Overall height excluding the antenna.	1,452 (57.2)
Wheelbase.	2,700 (106.3)
Front track.	1,561–1,581 (61.5–62.2)
Rear track.	1,543–1,563 (60.7–61.5)

# Capacities and Specifications

## TOWBAR DIMENSIONS - 5-DOOR

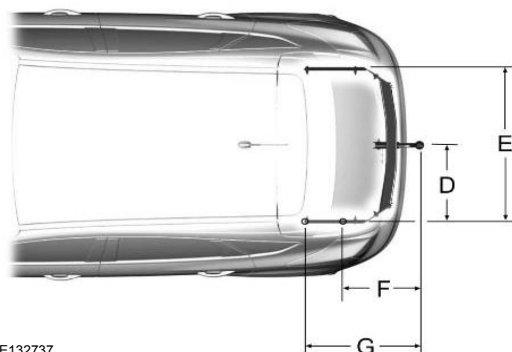
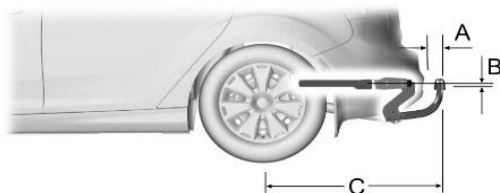

E132737

Item	Dimension Description	Dimension mm (in)
A	Bumper to center of tow ball.	102 (4.0)
B	Attachment point to center of tow ball.	6 (0.2)
C	Wheel center to center of tow ball.	869 (34.2)
D	Center of tow ball to side member.	525 (20.7)
E	Distance between side members.	1,047 (41.2)
F	Center of tow ball to center of first attachment point.	329 (13.0)
G	Center of tow ball to center of second attachment point.	569 (22.4)

# Capacities and Specifications

---

## Maximum Permissible Trailer Vertical Weight

<b>Powertrain</b>	<b>kg (lb)</b>
1.0L EcoBoost.	90 (198)
1.5L EcoBoost - automatic transmission.	75 (165)
1.5L EcoBoost - manual transmission.	90 (198)
1.5L EcoBlue - automatic transmission.	80 (176)
1.5L EcoBlue - manual transmission.	90 (198)
2.0L EcoBlue.	90 (198)
2.3L EcoBoost.	90 (198)

# Capacities and Specifications

## TOWBAR DIMENSIONS - WAGON

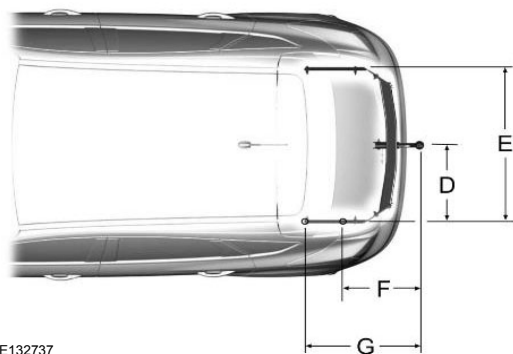
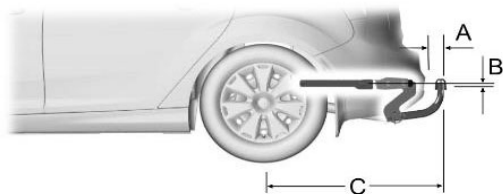

E132737

Item	Dimension Description	Dimension mm (in)
A	Bumper to center of tow ball.	87 (3.4)
B	Attachment point to center of tow ball.	6 (0.2)
C	Wheel center to center of tow ball.	1,145 (45.1)
D	Center of tow ball to side member.	525 (20.7)
E	Distance between side members.	1,047 (41.2)
F	Center of tow ball to center of first attachment point.	382 (15.0)
G	Center of tow ball to center of second attachment point.	622 (24.5)

# Capacities and Specifications

## Maximum Permissible Trailer Vertical Weight

Powertrain	kg (lb)
1.0L EcoBoost.	90 (198)
1.5L EcoBoost.	90 (198)
1.5L EcoBlue - automatic transmission.	90 (198)
1.5L EcoBlue - manual transmission.	80 (176)
2.0L EcoBlue.	90 (198)
2.3L EcoBoost.	90 (198)

## VEHICLE IDENTIFICATION PLATE

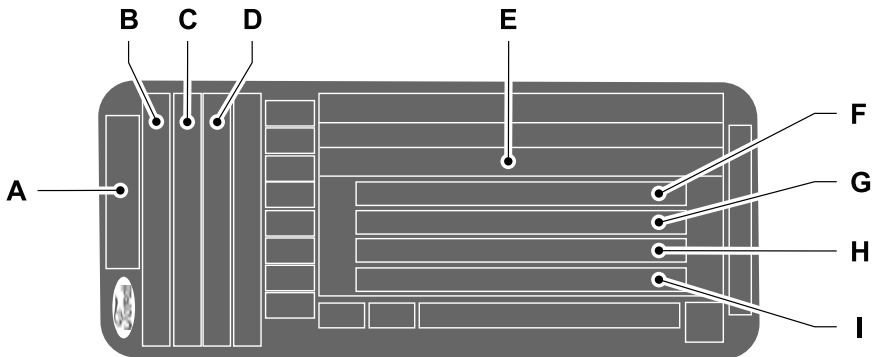

- A Model.
- B Variant.
- C Engine designation.
- D Engine power and emission level.
- E Vehicle identification number.
- F Gross vehicle weight.
- G Gross train weight.
- H Maximum front axle weight.
- I Maximum rear axle weight.

# Capacities and Specifications

The vehicle identification plate is within the right-hand door aperture.

**Note:** The vehicle identification plate may vary to that shown.

**Note:** Information on the vehicle identification plate is dependent upon market requirements.

## VEHICLE IDENTIFICATION NUMBER

You can find the vehicle identification number at the following locations.

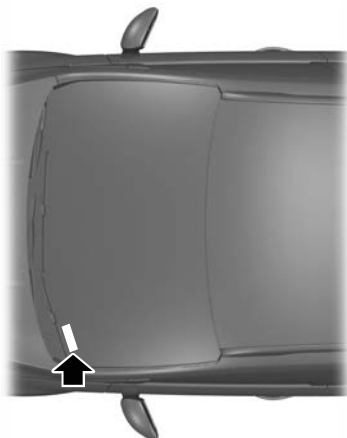

E163915

On the left-hand side of the instrument panel.

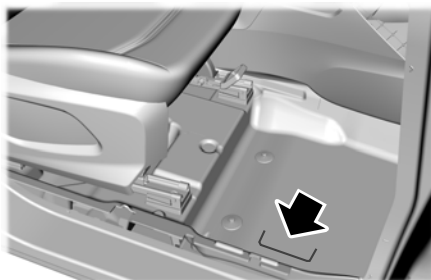

E163913

Stamped into the floor panel on the right-hand side, in front of the front seat.

## CAPACITIES AND SPECIFICATIONS - 1.0L ECOBOOST™

Use oil and fluid that meets the defined specification and viscosity grade.

If you do not use oil and fluid that meets the defined specification and viscosity grade, it could result in:

- Component damage not covered by the vehicle Warranty.
- Longer engine cranking periods.
- Increased emission levels.
- Reduced engine performance.
- Reduced fuel economy.
- Reduced brake performance.



# Capacities and Specifications

## Engine

### Engine Oil

#### Capacities

Variant	Including the Oil Filter	Excluding the Oil Filter
All.	4.5 L (1.0 gal)	4.4 L (1.0 gal)

**Note:** The quantity of engine oil required to raise the indicated level on the dipstick from minimum to maximum is 1 L (0.2 gal).

#### Materials

Name	Specification
Engine Oil - SAE 5W-20	WSS-M2C948-B

#### Engine Oil Top-Up

If you are unable to find an engine oil that meets the specification defined by WSS-M2C948-B, you can top-up with a SAE 5W-20 engine oil that is defined by ACEA A5/B5.

**Note:** Do not use more than 0.5 L (0.1 gal) of the alternative engine oil between scheduled service intervals.

### Engine Coolant

#### Capacities

Variant	Quantity
Vehicles with a manual transmission.	5.5 L (1.2 gal)
Vehicles with an automatic transmission.	5.8 L (1.3 gal)

#### Materials

Name	Specification
Antifreeze Super Plus Premium FU7J-19544-xx	WSS-M97B44-D

# Capacities and Specifications

## Fuel Tank

### Capacities

Variant	Quantity
Vehicles with standard fuel tank.	52 L (11.4 gal)
Vehicles with smaller fuel tank.	42 L (9.2 gal)

## Washer Reservoir

### Capacities

Variant	Quantity
Vehicles without headlamp washers.	4.2 L (0.9 gal)
Vehicles with headlamp washers.	5.8 L (1.3 gal)

## Materials

Name	Specification
Screen Wash FU7J-19C544-AA/BA/DA/EA/GA/HA	WSS-M14P19-A

## Brake System

### Materials

Name	Specification
Brake Fluid DOT 4 LV High Performance BU7J-M6C65-xxxx	WSS-M6C65-A2

## CAPACITIES AND SPECIFICATIONS - 1.5L TIVCT

Use oil and fluid that meets the defined specification and viscosity grade.

If you do not use oil and fluid that meets the defined specification and viscosity grade, it could result in:

- Component damage not covered by the vehicle Warranty.
- Longer engine cranking periods.
- Increased emission levels.
- Reduced engine performance.

# Capacities and Specifications

- Reduced fuel economy.
- Reduced brake performance.

## Engine

### Engine Oil

#### Capacities

Variant	Including the Oil Filter	Excluding the Oil Filter
All.	3.65 L (0.8 gal)	3.5 L (0.8 gal)

**Note:** The quantity of engine oil required to raise the indicated level on the dipstick from minimum to maximum is 0.6 L (0.1 gal).

#### Materials

Name	Specification
Engine Oil - SAE 5W-20	WSS-M2C948-B

#### Engine Oil Top-Up

If you are unable to find an engine oil that meets the specification defined by WSS-M2C948-B, you can top-up with a SAE 5W-20 engine oil that is defined by ACEA A5/B5.

**Note:** Do not use more than 0.6 L (0.1 gal) of the alternative engine oil between scheduled service intervals.

### Engine Coolant

#### Capacities

Variant	Quantity
All.	6 L (1.3 gal)

#### Materials

Name	Specification
Antifreeze Super Plus Premium FU7J-19544-xx	WSS-M97B44-D

# Capacities and Specifications

## Fuel Tank

### Capacities

Variant	Quantity
All.	52 L (11.4 gal)

## Washer Reservoir

### Capacities

Variant	Quantity
Vehicles without headlamp washers.	4.2 L (0.9 gal)
Vehicles with headlamp washers.	5.8 L (1.3 gal)

## Materials

Name	Specification
Screen Wash FU7J-19C544-AA/BA/DA/EA/GA/HA	WSS-M14P19-A

## Brake System

### Materials

Name	Specification
Brake Fluid DOT 4 LV High Performance BU7J-M6C65-xxxx	WSS-M6C65-A2

## CAPACITIES AND SPECIFICATIONS - 1.5L ECOBLUE

Use oil and fluid that meets the defined specification and viscosity grade.

If you do not use oil and fluid that meets the defined specification and viscosity grade, it could result in:

- Component damage not covered by the vehicle Warranty.
- Longer engine cranking periods.
- Increased emission levels.
- Reduced engine performance.
- Reduced fuel economy.
- Reduced brake performance.

# Capacities and Specifications

## Engine

### Engine Oil

#### Capacities

Variant	Including the Oil Filter
All.	6.2 L (1.4 gal)

**Note:** The quantity of engine oil required to raise the indicated level on the dipstick from minimum to maximum is 1.75 L (0.4 gal).

#### Materials

Name	Specification
Engine Oil - SAE 0W-20	WSS-M2C952-A1

#### Engine Oil Top-Up

If you are unable to find engine oil that meets the specification defined by WSS-M2C952-A1, you can top-up with a SAE 0W-20 engine oil that is defined by ACEA C5.

**Note:** Do not use more than 1L (0.2 gal) of the alternative engine oil between scheduled service intervals.

### Engine Coolant

#### Capacities

Variant	Quantity
Vehicles with a manual transmission.	6.7 L (1.5 gal)
Vehicles with an automatic transmission.	7.85 L (1.7 gal)

#### Materials

Name	Specification
Antifreeze Super Plus Premium FU7J-19544-xx	WSS-M97B44-D

# Capacities and Specifications

---

## Fuel Tank

### Capacities

Variant	Quantity
All.	47 L (10.3 gal)

## AdBlue® Tank

### Capacities

Variant	Quantity
All.	10.4 L (2.3 gal)

## Washer Reservoir

### Capacities

Variant	Quantity
Vehicles without headlamp washers.	4.2 L (0.9 gal)
Vehicles with headlamp washers.	5.8 L (1.3 gal)

## Materials

Name	Specification
Screen Wash FU7J-19C544-AA/BA/DA/EA/GA/HA	WSS-M14P19-A

## Brake System

### Materials

Name	Specification
Brake Fluid DOT 4 LV High Performance BU7J-M6C65-xxxx	WSS-M6C65-A2

# Capacities and Specifications

## CAPACITIES AND SPECIFICATIONS - 1.5L ECOBOOST™

Use oil and fluid that meets the defined specification and viscosity grade.

If you do not use oil and fluid that meets the defined specification and viscosity grade, it could result in:

- Component damage not covered by the vehicle Warranty.
- Longer engine cranking periods.
- Increased emission levels.
- Reduced engine performance.
- Reduced fuel economy.
- Reduced brake performance.

### Engine

#### Engine Oil

##### Capacities

Variant	Including the Oil Filter	Excluding the Oil Filter
All.	5.05 L (1.1 gal)	4.55 L (1.0 gal)

**Note:** The quantity of engine oil required to raise the indicated level on the dipstick from minimum to maximum is 0.7 L (0.2 gal).

##### Materials

Name	Specification
Engine Oil - SAE 5W-20	WSS-M2C948-B

##### Engine Oil Top-Up

If you are unable to find engine oil that meets the specification defined by WSS-M2C948-B, you can top-up with a SAE 5W-20 engine oil that is defined by ACEA A5/B5.

**Note:** Do not use more than 0.5 L (0.1 gal) of the alternative engine oil between scheduled service intervals.

#### Engine Coolant

##### Capacities

Variant	Quantity
Vehicles with manual transmission.	5.55 L (1.2 gal)
Vehicles with automatic transmission.	5.8 L (1.3 gal)

# Capacities and Specifications

---

## Materials

Name	Specification
Antifreeze Super Plus Premium FU7J-19544-xx	WSS-M97B44-D

## Fuel Tank

### Capacities

Variant	Quantity
All.	52 L (11.4 gal)

## Washer Reservoir

### Capacities

Variant	Quantity
Vehicles without headlamp washers.	4.2 L (0.9 gal)
Vehicles with headlamp washers.	5.8 L (1.3 gal)

## Materials

Name	Specification
Screen Wash FU7J-19C544-AA/BA/DA/EA/GA/HA	WSS-M14P19-A

## Brake System

### Materials

Name	Specification
Brake Fluid DOT 4 LV High Performance BU7J-M6C65-xxxx	WSS-M6C65-A2



# Capacities and Specifications

## CAPACITIES AND SPECIFICATIONS - 2.0L ECOBLUE

Use oil and fluid that meets the defined specification and viscosity grade.

If you do not use oil and fluid that meets the defined specification and viscosity grade, it could result in:

- Component damage not covered by the vehicle Warranty.
- Longer engine cranking periods.
- Increased emission levels.
- Reduced engine performance.
- Reduced fuel economy.
- Reduced brake performance.

### Engine

#### Engine Oil

##### Capacities

Variant	Including the Oil Filter
All.	6.4 L (1.4 gal)

**Note:** The quantity of engine oil required to raise the indicated level on the dipstick from minimum to maximum is 2 L (0.4 gal).

##### Materials

Name	Specification
Engine Oil - SAE 0W-30	WSS-M2C950-A

##### Engine Oil Top-Up

If you are unable to find an engine oil that meets the specification defined by WSS-M2C950-A, you can top-up with a SAE 0W-30 engine oil that is defined by ACEA C2.

**Note:** Do not use more than 1 L (0.2 gal) of the alternative engine oil between scheduled service intervals.

#### Engine Coolant

##### Capacities

Variant	Quantity
Vehicles with a manual transmission.	12.6 L (2.8 gal)
Vehicles with an automatic transmission.	11.6 L (2.6 gal)

# Capacities and Specifications

## Materials

Name	Specification
Antifreeze Super Plus Premium FU7J-19544-xx	WSS-M97B44-D

## Fuel Tank

### Capacities

Variant	Quantity
All.	47 L (10.3 gal)

## AdBlue® Tank

### Capacities

Variant	Quantity
All.	10.4 L (2.3 gal)

## Washer Reservoir

### Capacities

Variant	Quantity
Vehicles without headlamp washers.	4.2 L (0.9 gal)
Vehicles with headlamp washers.	5.8 L (1.3 gal)

## Materials

Name	Specification
Screen Wash FU7J-19C544-AA/BA/DA/EA/GA/HA	WSS-M14P19-A

## Brake System

# Capacities and Specifications

## Materials

Name	Specification
Brake Fluid DOT 4 LV High Performance BU7J-M6C65-xxxx	WSS-M6C65-A2

## CAPACITIES AND SPECIFICATIONS - 2.3L ECOBOOST™

Use oil and fluid that meets the defined specification and viscosity grade.

If you do not use oil and fluid that meets the defined specification and viscosity grade, it could result in:

- Component damage not covered by the vehicle Warranty.
- Longer engine cranking periods.
- Increased emission levels.
- Reduced engine performance.
- Reduced fuel economy.
- Reduced brake performance.

## Engine

### Engine Oil

#### Capacities

Variant	Including the Oil Filter	Excluding the Oil Filter
All.	5.3 L (1.2 gal)	4.9 L (1.1 gal)

**Note:** The quantity of engine oil required to raise the indicated level on the dipstick from minimum to maximum is 0.8 L (0.2 gal).

## Materials

Name	Specification
Engine Oil - SAE 0W-30	WSS-M2C950-A

### Engine Oil Top-Up

If you are unable to find an engine oil that meets the specification defined by WSS-M2C950-A, you can top up with a SAE 0W-30 engine oil that is defined by ACEA C2.

**Note:** Do not use more than 0.5 L (0.1 gal) of the alternative engine oil between scheduled service intervals.

# Capacities and Specifications

## Engine Coolant

### Capacities

Variant	Quantity
Vehicles with manual transmission.	7.2 L (1.6 gal)
Vehicles with automatic transmission.	7.6 L (1.7 gal)

### Materials

Name	Specification
Antifreeze Super Plus Premium FU7J-19544-xx	WSS-M97B44-D

## Fuel Tank

### Capacities

Variant	Quantity
All.	52 L (11.4 gal)

## Washer Reservoir

### Capacities

Variant	Quantity
Vehicles without headlamp washers.	4.2 L (0.9 gal)
Vehicles with headlamp washers.	5.8 L (1.3 gal)

### Materials

Name	Specification
Screen Wash FU7J-19C544-AA/BA/DA/EA/GA/HA	WSS-M14P19-A

## Brake System

# Capacities and Specifications

## Materials

Name	Specification
Brake Fluid DOT 4 LV High Performance BU7J-M6C65-xxxx	WSS-M6C65-A2

## BULB SPECIFICATION CHART

Lamp	Specification	Power (Watt)
Front direction indicator. <sup>1</sup>	PY21W	21
Front direction indicator. <sup>2</sup>	LED.	-
Daytime running lamp. <sup>1</sup>	LED.	-
Daytime running lamp. <sup>2</sup>	LED.	-
Headlamp low beam. <sup>1</sup>	H7	55
Headlamp low beam. <sup>2</sup>	LED.	-
Headlamp high beam. <sup>1</sup>	H1	55
Headlamp high beam. <sup>2</sup>	LED.	-
Front fog lamp. <sup>3</sup>	H8	35
Side direction indicator.	LED.	-
Rear lamp. <sup>4</sup>	W5W	5
Stoplamp.	P21W	21
High mounted stoplamp.	LED.	-
Rear direction indicator.	PY21W	21
Rear direction indicator. <sup>5</sup>	WY16W	16
Rear fog lamp.	LED.	-

## Capacities and Specifications

---

Lamp	Specification	Power (Watt)
Reversing lamp.	LED.	-
License plate lamp.	LED.	-

<sup>1</sup> Halogen Headlamp. See **Changing a Bulb** (page 434).

<sup>2</sup> LED Headlamp. See **Changing a Bulb** (page 434).

<sup>3</sup> Front fog lamps are also available as LED lamps.

<sup>4</sup> Rear lamps are also available as LED lamps.

<sup>5</sup> Wagon.

**Note:** We recommend that you have LEDs changed by an authorized dealer.

# Capacities and Specifications

## FUEL CONSUMPTION FIGURES

### Fuel Economy and CO<sub>2</sub> Emissions

The declared fuel/energy consumptions, CO<sub>2</sub>-Emissions and electric range are determined according to the technical requirements and specifications of the European Regulations (EC) 715/2007 and (EU) 2017/1151 as last amended. Light Duty Vehicle type-approved using the World Harmonised Light Vehicle Test Procedure (WLTP) will have Fuel/Energy Consumption and CO<sub>2</sub>-Emission information for New European Drive Cycle (NEDC) and WLTP. WLTP will fully replace the NEDC latest by the end of the year 2020. The applied standard test procedures enable comparison between different vehicle types and different manufacturers.

During NEDC phase-out, WLTP fuel consumption and CO<sub>2</sub> emissions are being correlated back to NEDC. There will be some variance to the previous fuel economy and emissions as some elements of the tests have altered, so the same car might have different fuel consumption and CO<sub>2</sub> emissions.

### European Directive 1999/94/EC

In addition to the fuel efficiency of a car, driving behaviour as well as other non-technical factors play a role in determining a car's fuel consumption and CO<sub>2</sub> emissions. CO<sub>2</sub> is the main greenhouse gas responsible for global warming. A guide on fuel economy and CO<sub>2</sub> emissions which contains data for all new passenger car models is available at any point of sale free of charge.

## FUEL CONSUMPTION FIGURES - 1.0L ECOBOOST™

### NEDC

Urban	Extra-Urban	Combined	CO <sub>2</sub> Emissions
L/100 km (mpg)	L/100 km (mpg)	L/100 km (mpg)	g/km
7.5–4.7 (38–60)	5.2–3.5 (54–81)	6–4.1 (47–69)	93–136

### WLTP

Low	Medium	High	Extra-High	Combined	CO <sub>2</sub> Emissions
L/100 km (mpg)	L/100 km (mpg)	L/100 km (mpg)	L/100 km (mpg)	L/100 km (mpg)	g/km
9–6 (31–47)	6.5–4.7 (43–60)	5.8–4.2 (49–67)	7–5.1 (40–55)	7.5–4.9 (38–58)	112–167

# Capacities and Specifications

## FUEL CONSUMPTION FIGURES - 1.5L TIVCT

### NEDC

Urban	Extra-Urban	Combined	CO <sub>2</sub> Emissions
L/100 km (mpg)	L/100 km (mpg)	L/100 km (mpg)	g/km
9.3–7.9 (30–36)	5.5–4.5 (51–63)	6.9–5.8 (41–49)	131–156

### WLTP

Low	Medium	High	Extra-High	Combined	CO <sub>2</sub> Emissions
L/100 km (mpg)	L/100 km (mpg)	L/100 km (mpg)	L/100 km (mpg)	L/100 km (mpg)	g/km
11.6–9 (24–31)	7.8–6.2 (36–46)	6.6–5.3 (43–53)	7.9–5.9 (36–48)	8–6.2 (35–46)	140–180



# Capacities and Specifications

## FUEL CONSUMPTION FIGURES - 1.5L ECOBLUE

### NEDC

Urban	Extra-Urban	Combined	CO <sub>2</sub> Emissions
L/100 km (mpg)	L/100 km (mpg)	L/100 km (mpg)	g/km
5.2–3.8 (54–74)	4.4–3.1 (64–91)	4.7–3.4 (60–83)	89–123

### WLTP

Low	Medium	High	Extra-High	Combined	CO <sub>2</sub> Emissions
L/100 km (mpg)	L/100 km (mpg)	L/100 km (mpg)	L/100 km (mpg)	L/100 km (mpg)	g/km
6.5–4.7 (43–60)	5.6–4 (50–71)	5–3.5 (56–81)	6.1–4.2 (46–67)	5.7–4 (50–71)	106–149

# Capacities and Specifications

## FUEL CONSUMPTION FIGURES - 1.5L ECOBOOST™

### NEDC

Urban	Extra-Urban	Combined	CO <sub>2</sub> Emissions
L/100 km (mpg)	L/100 km (mpg)	L/100 km (mpg)	g/km
7.8–6.2 (36–46)	5.2–4 (54–71)	6.2–4.8 (46–59)	109–139

### WLTP

Low	Medium	High	Extra-High	Combined	CO <sub>2</sub> Emissions
L/100 km (mpg)	L/100 km (mpg)	L/100 km (mpg)	L/100 km (mpg)	L/100 km (mpg)	g/km
10.1–7.5 (28–38)	7.3–5.5 (39–51)	6.4–4.7 (44–60)	7.4–5.5 (38–51)	7.4–5.5 (38–51)	126–168

# Capacities and Specifications

## FUEL CONSUMPTION FIGURES - 2.0L ECOBLUE

### NEDC

Urban	Extra-Urban	Combined	CO <sub>2</sub> Emissions
L/100 km (mpg)	L/100 km (mpg)	L/100 km (mpg)	g/km
6.2–4.9 (46–58)	4.5–3.5 (63–81)	5.1–4.1 (55–69)	108–132

### WLTP

Low	Medium	High	Extra-High	Combined	CO <sub>2</sub> Emissions
L/100 km (mpg)	L/100 km (mpg)	L/100 km (mpg)	L/100 km (mpg)	L/100 km (mpg)	g/km
10.4–5.7 (27–50)	6.4–4.7 (44–60)	5.2–3.9 (54–72)	5.8–4.6 (49–61)	6.4–4.6 (44–61)	119–167

# Capacities and Specifications

## FUEL CONSUMPTION FIGURES - 2.3L ECOBOOST™

### NEDC

Urban	Extra-Urban	Combined	CO <sub>2</sub> Emissions
L/100 km (mpg)	L/100 km (mpg)	L/100 km (mpg)	g/km
11.6–10.8 (24–26)	6.2–5.6 (46–50)	8.2–7.6 (34–37)	176–188

### WLTP

Low	Medium	High	Extra-High	Combined	CO <sub>2</sub> Emissions
L/100 km (mpg)	L/100 km (mpg)	L/100 km (mpg)	L/100 km (mpg)	L/100 km (mpg)	g/km
13.5–11.5 (21–25)	8.3–7.3 (34–39)	7–6.5 (40–43)	7.8–7 (36–40)	8.3–7.6 (34–37)	174–190

# Connected Vehicle

## WHAT IS A CONNECTED VEHICLE

A connected vehicle has technology that allows your vehicle to connect to a mobile network and for you to access a range of features. When used in conjunction with the FordPass app, it could allow you to monitor and control your vehicle further, for example checking the tire pressures, the fuel level and the vehicle location. For additional information, refer to the local Ford website.

## CONNECTED VEHICLE REQUIREMENTS

Connected service and related feature functionality requires a compatible vehicle network.

Some remote features require additional service activation. Log in to your Ford account for details. Some restrictions, third party terms and message or data rates may apply.

## CONNECTED VEHICLE LIMITATIONS

Evolving technology, cellular networks, or regulations could affect functionality and availability, or continued provision of some features. These changes could even stop some features from functioning.

## CONNECTING THE VEHICLE TO A MOBILE NETWORK

### What Is the Modem



The modem allows access to a range of features built into your vehicle.

## Enabling and Disabling the Modem - Vehicles With: 4.2 Inch Information and Entertainment Display Screen

1. Select **Settings**.
2. Select **Connectivity features**.
3. Select **Data sharing**.
4. Switch connectivity features on or off.

## Enabling and Disabling the Modem - Vehicles With: 8 Inch Information and Entertainment Display Screen/SYNC 3

1. Press **Settings**.
2. Press **FordPass Connect**.
3. Press **Connectivity settings**.
4. Switch connectivity features on or off.

## Connecting FordPass to the Modem

1. Make sure that the modem is enabled using the vehicle settings menu.
2. Open the FordPass app on your device and log in.
3. Add your vehicle or select your vehicle if already added.
4. Select the option for vehicle details.
5. Select the option to activate your vehicle.
6. Make sure that the name on the screen matches the name shown in your FordPass account.
7. Confirm that FordPass account is connected to the modem.

## CONNECTING THE VEHICLE TO A WI-FI NETWORK

1. Press **Settings**.

## Connected Vehicle

---

2. Press **Wi-Fi**.
  3. Switch **Wi-Fi** on.
  4. Press **View available networks**.
  5. Select an available Wi-Fi network.
- Note:** Enter the network password to connect to a secure network.

### CONNECTED VEHICLE – TROUBLESHOOTING - VEHICLES WITH: MODEM

Symptom	Possible Cause and Resolution
I cannot confirm the connection of my FordPass account to the modem.	<ul style="list-style-type: none"><li>– Modem is not enabled.<ul style="list-style-type: none"><li>• Switch connectivity features on.</li></ul></li><li>– Weak network signal.<ul style="list-style-type: none"><li>• Move your vehicle closer to a place where the network signal is not obstructed.</li></ul></li></ul>

## Connected Vehicle

### CONNECTED VEHICLE – TROUBLESHOOTING - VEHICLES WITH: SYNC 3/SYNC 2.5

Symptom	Possible Cause and Resolution
I cannot connect to a Wi-Fi network.	<ul style="list-style-type: none"> <li>– Password error.               <ul style="list-style-type: none"> <li>• Enter the correct network password.</li> </ul> </li> <li>– Weak network signal.               <ul style="list-style-type: none"> <li>• Move your vehicle closer to the Wi-Fi hotspot or to a place where the network signal is not obstructed.</li> </ul> </li> <li>– Multiple access points in range with the same SSID.               <ul style="list-style-type: none"> <li>• Use a unique name for your SSID. Do not use the default name unless it contains a unique identifier, for example as part of the MAC address.</li> </ul> </li> </ul>
The Wi-Fi connection disconnects after successful connection.	<ul style="list-style-type: none"> <li>– Weak network signal.               <ul style="list-style-type: none"> <li>• Move your vehicle closer to the Wi-Fi hotspot or to a place where the network signal is not obstructed.</li> </ul> </li> </ul>
I am close to a Wi-Fi hotspot but the network signal strength is weak.	<ul style="list-style-type: none"> <li>– Obstructed network signal.               <ul style="list-style-type: none"> <li>• If your vehicle has a heated windshield, position your vehicle so that the windshield is not facing the Wi-Fi hotspot.</li> <li>• If your vehicle has metallic tinting on the windows but not on the windshield, position your vehicle so that the windshield is facing the Wi-Fi hotspot or open the windows that are facing the hotspot.</li> <li>• If your vehicle has metallic tinting on the windows and the windshield, open the windows that are facing the hotspot.</li> <li>• If your vehicle is in a garage and you have the garage door closed, open the garage door.</li> </ul> </li> </ul>
I cannot see a network in the list of available networks that I expect to see.	<ul style="list-style-type: none"> <li>– Hidden network.               <ul style="list-style-type: none"> <li>• Make the network visible and try again.</li> </ul> </li> </ul>

# Connected Vehicle

<b>Symptom</b>	<b>Possible Cause and Resolution</b>
I cannot see the Wi-Fi hotspot name when I search for Wi-Fi networks on my cell phone or other device.	<ul style="list-style-type: none"><li>– System limitation.<ul style="list-style-type: none"><li>• Make sure Wi-Fi hotspot visibility is on.</li><li>• The system does not provide a Wi-Fi hotspot at this time.</li></ul></li></ul>
Software downloads take too long.	<ul style="list-style-type: none"><li>– Weak network signal.<ul style="list-style-type: none"><li>• Move your vehicle closer to the Wi-Fi hotspot or to a place where the network signal is not obstructed.</li></ul></li><li>– Wi-Fi hotspot in high demand or has a slow Internet connection.<ul style="list-style-type: none"><li>• Use a more reliable Wi-Fi hotspot.</li></ul></li></ul>
The system seems to connect to a Wi-Fi network and the signal strength is excellent but the software does not update.	<ul style="list-style-type: none"><li>– No software update available.</li><li>– Wi-Fi network requires a subscription or acceptance of terms and conditions.<ul style="list-style-type: none"><li>• Test the connection using another device. If the network requires a subscription or acceptance of terms and conditions, contact the network service provider.</li></ul></li></ul>



# Vehicle Wi-Fi Hotspot

---

## CREATING A VEHICLE WI-FI HOTSPOT

You can create a Wi-Fi hotspot in your vehicle and allow devices to connect to it for access to the Internet.

1. Select **Settings**.
2. Select **FordPass Connect**.
3. Select **Vehicle Hotspot**.

**Note:** The vehicle hotspot default setting is on.

4. Select **Settings**.
5. Select **Edit**.
6. Select **Wi-Fi visibility**.

**Note:** The Wi-Fi Visibility default setting is on.

## Finding the Wi-Fi Hotspot Name and Password

1. Select **Settings**.
2. Select **FordPass Connect**.
3. Select **Vehicle Hotspot**.
4. Select **Settings**.

**Note:** The SSID is the hotspot name.

5. Select **View password**.

## Connecting a Device to the Wi-Fi Hotspot

1. On your device, turn on Wi-Fi and select the hotspot from the list of available Wi-Fi networks.
2. When prompted, enter the password.

## Purchasing a Data Plan

1. Connect a device to the hotspot.

**Note:** The vehicle network carrier's portal opens on your device.

2. If the portal does not open on your device, open a website and it redirects to the vehicle network carrier's portal.

**Note:** Secure websites do not redirect.

**Note:** If you have an active plan, the system does not redirect to the vehicle network carrier's portal when you connect a device. Visit the vehicle network carrier's website to purchase more data.

**Note:** If data usage information is available in the vehicle hotspot menu, it is approximate.

**Note:** If you carry out a master reset, the system does not remove your vehicle from your vehicle network carrier's account. To remove your vehicle from the account, contact your vehicle network carrier.

**Note:** The vehicle network carrier provides Vehicle Hotspot services, subject to your vehicle network carrier agreement, coverage and availability.

## CHANGING THE VEHICLE WI-FI HOTSPOT NAME OR PASSWORD

1. Select **Settings**.
2. Select **FordPass Connect**.
3. Select **Vehicle Hotspot**.
4. Select **Settings**.
5. Select **Edit**.
6. Select **Change SSID name**.
7. Enter your required SSID.
8. Select **Done**.
9. Select **Change password**.
10. Enter your required password.
11. Select **Done**.

# Audio System

## GENERAL INFORMATION

**Note:** *Listening to loud audio for long periods of time could damage your hearing.*

### Radio Frequencies and Reception Factors

Radio reception factors	
Distance and Strength	The further you travel away from an FM station, the weaker the signal and the weaker the reception.
Terrain	Hills, mountains, tall buildings, bridges, tunnels, freeway overpasses, parking garages, dense tree foliage and thunderstorms can interfere with the reception.
Station overload	When you pass near a radio transmission tower, a stronger signal can override a weaker signal and can cause interference in the audio system.

## AUDIO UNIT - VEHICLES WITHOUT: SYNC

### Switching the Audio Unit On and Off



### Adjusting the Volume

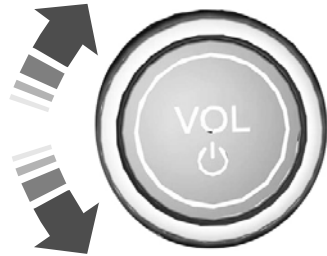

### Selecting the Radio



Press the button to select radio mode.

# Audio System

Press the button again to display the available radio sources. Repeatedly press the button to scroll through the available radio sources.

## Changing Radio Stations



E248947

Rotate the control to change radio stations.

**Note:** You can change the radio frequency by using the seek buttons.

**Note:** You can recall radio stations using the numeric preset buttons.

## Selecting Media



Press the button to select media mode.

Press the button again to display the available media sources. Repeatedly press the button to scroll through the available media sources.

## Scrolling Through the Menu Options



E248947

## Selecting a Menu Option



E248946

## Returning to the Previous Screen



## Seek Up and Next Track Button



Select to skip to the next track.  
Press and hold the button to fast forward through the track.

# Audio System

## Seek Down and Previous Track Button



Select to return to the beginning of a track.

Repeatedly press the button to return to previous tracks.

Press and hold the button to fast rewind.

## Pausing or Playing Media



In media mode, press the button to pause playback. Press the button again to resume playback.

In radio mode, press the button to mute the radio. Press the button again to unmute.

## Switching the Screen On and Off



## System Settings



## Sound Settings



Press the button to adjust the sound settings. You can optimize the sound for different seating positions.

You can also activate and set the sensitivity of the speed compensated volume.

## Using a Cell Phone



You can make a call from a recent call list, contact list or dial a number.

## AUDIO UNIT - VEHICLES WITH: SYNC 3

### Switching the Audio Unit On and Off



### Adjusting the Volume

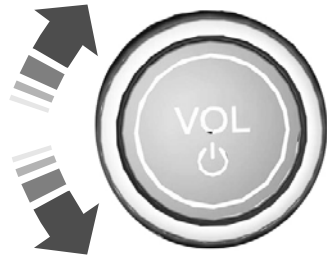

# Audio System

## Changing Radio Stations

### Manual Tuning

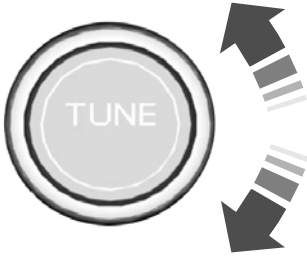

**Note:** You can change radio stations using the seek buttons.

**Note:** You can recall radio stations using the preset buttons on the touchscreen.

### Next Track Button



Select to skip to the next track.

Press and hold the button to fast forward through the track.

### Previous Track Button



Select to return to the beginning of a track.

Repeatedly press the button to return to previous tracks.

Press and hold the button to fast rewind.

### Pausing or Playing Media



Select to play a track. Press the button again to pause the track.

In radio mode, press the button to mute the radio. Press the button again to unmute.

### Switching the Screen On and Off



### Sound Settings



Press the button to adjust the sound settings. You can optimize the sound for different seating positions.

You can also activate and set the sensitivity of the speed compensated volume.

## AUDIO UNIT - VEHICLES WITH: SYNC 2.5

### Switching the Audio Unit On and Off



# Audio System

## Adjusting the Volume

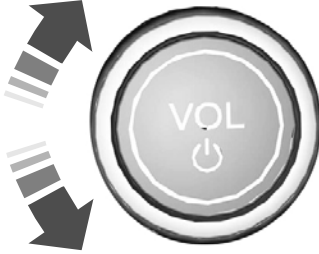

## Changing Radio Stations

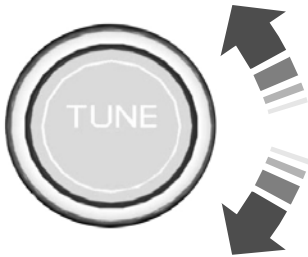

Rotate the control to change radio stations.

**Note:** You can change the radio frequency by using the seek buttons.

**Note:** You can recall radio stations using the preset buttons on the touchscreen.

## Next Track Button



Select to skip to the next track. Press and hold the button to fast forward through the track.

## Previous Track Button



Select to return to the beginning of a track.

Repeatedly press the button to return to previous tracks.

Press and hold the button to fast rewind.

## Pausing or Playing Media



Select to play a track. Press the button again to pause the track.

In radio mode, press the button to mute the radio. Press the button again to unmute.

## Switching the Screen On and Off



## Sound Settings



Press the button to adjust the sound settings. You can optimize the sound for different seating positions.

You can also activate and set the sensitivity of the speed compensated volume.

# Audio System

## AM/FM RADIO - VEHICLES WITHOUT: SYNC

### Selecting a Radio Source



1. Press the button to display the available radio sources.
2. Repeatedly press the button to scroll to the desired radio source.
3. Press the **OK** button.

### Station Presets

To store a radio station, press and hold one of the numeric preset buttons.

**Note:** Six presets can be stored for each radio source.

### Manually Changing Radio Stations



E248947

Rotate the control to change radio stations.

**Note:** You can change the radio frequency by using the seek buttons.

### Automatically Changing Radio Stations



Press to seek the next station up the frequency band.

Press and hold to quickly seek up the frequency band.



Press to seek the next station down the frequency band.

Press and hold to quickly seek down the frequency band.

### Selecting a Station from the List

Press the **OK** button to view available stations.

## AM/FM RADIO - VEHICLES WITH: SYNC 2.5

### Using the Radio



Select the audio option on the feature bar.

### Selecting a Radio Station From a List

1. Select **Sources**.
2. Select **FM**.
3. Select **Stations**.
4. Select a radio station from the list.

# Audio System

## Manually Changing Radio Stations

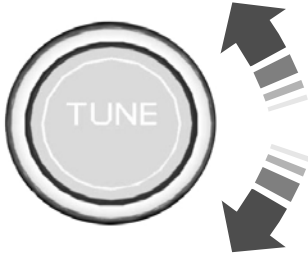

Rotate the control to change radio stations.

**Note:** You can change the radio frequency by using the seek buttons.

## Automatically Changing Radio Stations



Press to seek the next station up the frequency band.

Press and hold to quickly seek up the frequency band.



Press to seek the next station down the frequency band.

Press and hold to quickly seek down the frequency band.

## Storing a Radio Station

Press and hold one of the preset buttons on the touchscreen.

**Note:** The radio briefly mutes to indicate the station has been stored.

## DIGITAL RADIO - VEHICLES WITHOUT: SYNC

### Selecting a Radio Source



1. Press the button to display the available radio sources.
2. Repeatedly press the button to scroll to the desired radio source.
3. Press the **OK** button.

### Station Presets

To store a station, press and hold one of the numeric preset buttons.

**Note:** Six presets can be stored for each radio source.

### Manually Changing Stations



E248947

Rotate the control to change radio stations.

**Note:** You can change the radio frequency by using the seek buttons.



# Audio System

## Automatically Changing Radio Stations



Press to seek the next station up the frequency band.

Press and hold to quickly seek up the frequency band.



Press to seek the next station down the frequency band.

Press and hold to quickly seek down the frequency band.

## Selecting a Station from the List

Press the **OK** button to view available ensembles. Select the desired ensemble and station from the list.

## DIGITAL RADIO - VEHICLES WITH: SYNC 2.5

### Using the Radio



Select the audio option on the feature bar.

### Selecting a Radio Station From a List

1. Select **Sources**.
2. Select **DAB**.
3. Select **Stations**.
4. Select a radio station from the list.

## Manually Changing Radio Stations

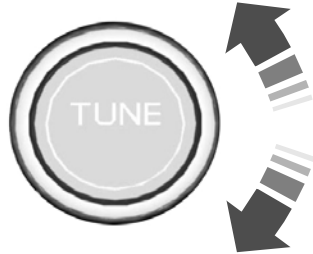

Rotate the control to change radio stations.

**Note:** You can change the radio frequency by using the seek buttons.

## Automatically Changing Radio Stations



Press to seek the next station up the frequency band.

Press and hold to quickly seek up the frequency band.



Press to seek the next station down the frequency band.

Press and hold to quickly seek down the frequency band.

## Storing a Radio Station

Press and hold one of the preset buttons on the touchscreen.

**Note:** The radio briefly mutes to indicate the station has been stored.

# Audio System

## AUDIO UNIT CLOCK AND DATE DISPLAYS - VEHICLES WITHOUT: SYNC

### Adjusting the Clock



Press the button.

Select the clock and follow the instructions on the screen.

## AUDIO UNIT CLOCK AND DATE DISPLAYS - VEHICLES WITH: SYNC 2.5



Select the settings option on the feature bar.

1. Select **Clock**.
2. Adjust the clock.

## CONNECTING A BLUETOOTH® DEVICE - VEHICLES WITHOUT: SYNC

### Pairing a Device



Press the button.

Select **Bluetooth®** and follow the instructions on the screen.

**Note:** When pairing a new device, you can choose to download contacts, set this as the primary device and enable Emergency Assistance.

## CONNECTING A BLUETOOTH® DEVICE - VEHICLES WITH: SYNC 2.5

Go to the settings menu on your device and switch **Bluetooth®** on.



Select the settings options on the feature bar.

1. Select **Bluetooth**.
2. Switch **Bluetooth®** on.
3. Select **Add a Bluetooth device**.

**Note:** A prompt alerts you to search for your vehicle on your device.

4. Select your vehicle on your device.

**Note:** A number appears on your device and on the touchscreen.

5. Confirm that the number on your device matches the number on the touchscreen.

**Note:** The touchscreen indicates that you have successfully paired your device.

## STREAMING BLUETOOTH AUDIO - VEHICLES WITHOUT: SYNC

### Selecting a Bluetooth® Source



1. Press the button to display the menu.
2. Repeatedly press the button to scroll to the **Bluetooth®** device.
3. Press the **OK** button.



Press the button to play the track. Press the button again to pause the track.

# Audio System



Press the button to skip to the next track.

Press and hold the button to fast forward through the track.



Press the button once to return to the beginning of the track.

Repeatedly press the button to return to previous tracks.

Press and hold the button to fast rewind.

**Note:** *Not all functions are supported by all phones.*

## STREAMING BLUETOOTH AUDIO - VEHICLES WITH: SYNC 2.5

Check the compatibility of your device on the local Ford website.

Pair your device. See **Connecting a Bluetooth® Device** (page 510).



Select the audio option on the feature bar.

Select **Sources**.



Select the **Bluetooth®** option.



Press the button to play the track. Press the button again to pause the track.



Press the button to skip to the next track.

Press and hold the button to fast forward through the track.



Press the button once to return to the beginning of the track.

Repeatedly press the button to return to previous tracks.

Press and hold the button to fast rewind.

## PLAYING MEDIA FROM A USB DEVICE - VEHICLES WITHOUT: SYNC

### Supported Audio File Formats

You can play audio file formats including MP3, WMA, WAV, M4A, M4B, AAC, and FLAC.

**Note:** *The NTFS file system is not supported.*

### Selecting the USB Device



Press the button to display the menu.

Repeatedly press the button to scroll to your USB device.

Press the **OK** button.

### Playing from the USB Device



Press the button to play a track. Press the button again to pause the track.



Press the button to skip to the next track.

Press and hold the button to fast forward through the track.



Press the button once to return to the beginning of a track.

Repeatedly press the button to return to previous tracks.

Press and hold the button to fast rewind.

### Sorting by Categories

You can also sort and play music by specific categories, for example artist or album.

Press the **OK** button to view the available categories.

# Audio System

## PLAYING MEDIA FROM A USB DEVICE - VEHICLES WITH: SYNC 2.5

### Supported File Formats

The system supports the following file formats:

- MP3, M4A, M4B, WMA, WAV, AAC, FLAC, APE and AIFF audio file formats.
- ext2, exFAT, FAT, FAT32, NTFS and HFS+ file systems.

### Selecting the USB Device

Connect your device to the USB port.



Select the audio option on the feature bar.

Select **Sources**.



Select the USB option.

### Playing from the USB Device



Press the button to play a track. Press the button again to pause the track.



Press the button to skip to the next track.

Press and hold the button to fast forward through the track.



Press the button once to return to the beginning of a track. Repeatedly press the button to return to previous tracks.

Press and hold the button to fast rewind through the track.

### Sorting by Categories

You can also sort and play music by specific categories, for example artist or album.

## USB PORT

USB ports may be in the following locations:

- On the instrument panel below the climate control. See **Visual Search** (page 25).
- In the center console.

You can use the USB port to charge a device only when the engine is running.

## APPS - VEHICLES WITH: SYNC 2.5

**Note:** We recommend that you check your data plan before using your apps through the system. Using them could result in additional charges.

**Note:** We recommend that you check the app provider's terms and conditions and privacy policy before using their app.

**Note:** Make sure that you have an active account for apps that you want to use through the system.

**Note:** Some apps will work with no setup. Others require you to configure some personal settings before you can use them.

### Using Apple CarPlay

#### Switching Apple CarPlay On

1. Connect your device to a USB port.
2. Follow the instructions on the touchscreen.

**Note:** Certain features of the system are not available when you are using Apple CarPlay.

# Audio System

## Switching Apple CarPlay Off



Select the settings option on the feature bar.

1. Select **Apple CarPlay preferences**.
2. Disable Apple CarPlay.

## Using Apps on an iOS Device

**Note:** For more information about available apps, refer to the local Ford website.

When you start an app through the system for the first time, you could be asked to grant certain permissions. You can review and change the permissions that you have granted at any time when your vehicle is not moving.



Select the apps option on the feature bar.

1. Switch Apple CarPlay off.
2. Connect your device to a USB port.
3. Start the apps on your device that you want to use through the system.

**Note:** If you close the apps on your device, you will not be able to use them through the system.

4. Select **Find mobile apps**.

**Note:** The system searches and connects to compatible apps that are running on your device.

5. Select the app that you want to use on the touchscreen.

## Using Android Auto

### Switching Android Auto On

1. Connect your device to a USB port.
2. Follow the instructions on the touchscreen.

**Note:** You might need to enable Android Auto from the settings menu.

**Note:** Certain features of the system are not available when you are using Android Auto.

### Switching Android Auto Off



Select the settings option on the feature bar.

1. Select **Android Auto preferences**.
2. Disable Android Auto.

## Using Apps on an Android Device

**Note:** For more information about available apps, refer to the local Ford website.

When you start an app through the system for the first time, you could be asked to grant certain permissions. You can review and change the permissions that you have granted at any time when your vehicle is not moving.



Select the apps option on the feature bar.

1. Switch Android Auto off.
2. Pair your device.
3. Start the apps on your device that you want to use through the system.

**Note:** If you close the apps on your device, you will not be able to use them through the system.

4. Select **Find mobile apps**.

**Note:** The system searches and connects to compatible apps that are running on your device.

5. Select the app that you want to use on the touchscreen.

# Audio System

## Apps Troubleshooting

Symptom	Possible Cause and Resolution
The system cannot find any apps.	<ul style="list-style-type: none"><li>- Incompatible device.<ul style="list-style-type: none"><li>• You will need an Android device with OS 2.3 or higher or an iOS 3GS device with iOS 5.0 or higher. Pair and connect your Android device to find AppLink compatible apps. Connect your iOS device to a USB port to find AppLink compatible apps.</li></ul></li></ul>
I have a compatible device and it is correctly connected but the system still cannot find any apps.	<ul style="list-style-type: none"><li>- AppLink compatible apps not installed on your device.<ul style="list-style-type: none"><li>• Download and install the latest version of the app.</li></ul></li><li>- AppLink compatible apps not running on your device.<ul style="list-style-type: none"><li>• Start the apps to allow the system to find them and make sure you sign in to any apps if required.</li></ul></li><li>- Incorrect app settings.<ul style="list-style-type: none"><li>• Check and adjust the app settings on your device and allow the system to access the app if required.</li></ul></li></ul>
I have a compatible device, it is correctly connected and my apps are running but the system still cannot find any apps.	<ul style="list-style-type: none"><li>- Apps failed to fully close.<ul style="list-style-type: none"><li>• Restart the apps and try again.</li></ul></li></ul>
I have an Android device that is correctly connected, I have restarted my apps and they are running but the system still cannot find them.	<ul style="list-style-type: none"><li>- An issue on some older versions of the Android operating system could result in apps not being found.<ul style="list-style-type: none"><li>• Switch <b>Bluetooth</b>® off and on again to force the system to reconnect to your device.</li></ul></li></ul>

# Audio System

Symptom	Possible Cause and Resolution
I have an iOS device that is correctly connected, I have restarted my apps and they are running but the system still cannot find them.	<ul style="list-style-type: none"><li>– Cable connection issue.<ul style="list-style-type: none"><li>• Disconnect the cable from your device, wait for a moment and then connect it again to force the system to reconnect to your device.</li></ul></li></ul>
I have an Android device running a media app which the system has found but I cannot hear the sound or the sound is very quiet.	<ul style="list-style-type: none"><li>– Device volume is low.<ul style="list-style-type: none"><li>• Turn the volume up on your device.</li></ul></li></ul>
I have an Android device running a number of compatible apps but the system cannot find all of them.	<ul style="list-style-type: none"><li>– Device limitation. Some Android devices have a limited number of <b>Bluetooth®</b> ports that apps can use to connect. If you have more apps running on your device than the number of available <b>Bluetooth®</b> ports, the system cannot find all of them.<ul style="list-style-type: none"><li>• Close some of the apps to allow the system to find those that you want to use.</li></ul></li></ul>

## USING VOICE RECOGNITION

### Phone Voice Service

This system allows you to use the voice recognition features of your phone and focus on your driving.



Press the voice control button on the steering wheel.

**Note:** This only works when connected via **Bluetooth®**. See **Connecting a Bluetooth® Device** (page 510).

**Note:** When using voice recognition use the language set on the device.

**Note:** We recommend that you check your data plan before using your phone voice service through the system. Using them could result in additional charges.

# Audio System

## AUDIO SYSTEM – TROUBLESHOOTING - VEHICLES WITH: SYNC 2.5

Symptom	Possible Cause and Resolution
The system is not functioning.	<ul style="list-style-type: none"><li>You can reset the system to restore functionality that has stopped working.<ul style="list-style-type: none"><li>The system reset is designed to restore functionality and does not delete any personal data that you have stored.</li></ul></li></ul>
I want to delete personal data from the system.	<ul style="list-style-type: none"><li>A master reset is required to restore the system back to factory settings.<ul style="list-style-type: none"><li>This deletes any personal data that you have stored.</li></ul></li></ul>
The system is not up to date.	<ul style="list-style-type: none"><li>The latest version has not been installed.<ul style="list-style-type: none"><li>You can download the latest version or set the system to automatically update.</li></ul></li></ul>

### Resetting the System

1. Simultaneously press and hold the seek up and the audio unit power buttons until the screen goes black.
2. Wait three minutes to allow the system to complete the reset.

### Updating the System

**Note:** We may need to update operating system software on your vehicle, including security updates and bug fixes, to keep connected services current, like Vehicle Hotspot, without prior notice to you.

### Updating the System Using a USB Drive

#### Downloading an Update

1. Go to the system update page on the local Ford website.
2. Download the update.

**Note:** The website notifies you if an update is available.

3. Insert a USB drive into your computer.

**Note:** The USB drive needs to be empty and meet the minimum requirements detailed on the website.

4. Follow the instructions provided to download the update to the USB drive.

#### Installing an Update

**Note:** You can use the system when an installation is in progress.

1. Disconnect all other USB devices from the USB ports.
2. Connect the USB drive with the update to a USB port.

**Note:** Installation starts automatically within 10 minutes.

### Updating the System Using a Wi-Fi Network Connection

#### Connecting to a Wi-Fi Network



Select the settings option on the feature bar.



# Audio System

---

1. Select **Wi-Fi**.
2. Select **View available networks**.
3. Select an available network.

**Note:** Enter the network password to connect to a secure network.

## Switching Automatic System Updates On



Select the settings option on the feature bar.

1. Select **Automatic updates**.
2. Switch automatic system updates on.

The system is now set to check for and receive system updates when it is connected to a Wi-Fi network.

**Note:** You can use the system when a download is in progress.

**Note:** If the system is disconnected from the Wi-Fi network when a download is in progress, the download continues the next time the system is connected to a Wi-Fi network.

## Master Reset



Select the settings option on the feature bar.

1. Select **General**.
2. Select **Master reset**.
3. Select **Continue**.

**Note:** If you carry out a master reset, the system does not remove your vehicle from your vehicle network carrier's account. To remove your vehicle from the account, contact your vehicle network carrier.

**Note:** If you carry out a master reset, the system removes any authorized users and personal data.

## GENERAL INFORMATION



**WARNING:** Driving while distracted can result in loss of vehicle control, crash and injury. We strongly recommend that you use extreme caution when using any device that may take your focus off the road. Your primary responsibility is the safe operation of your vehicle. We recommend against the use of any hand-held device while driving and encourage the use of voice-operated systems when possible. Make sure you are aware of all applicable local laws that may affect the use of electronic devices while driving.

### About SYNC

The system allows you to interact with the entertainment, information and communication systems on your vehicle using voice commands and a touchscreen. The system provides easy interaction with audio, phone, navigation, mobile apps and settings.

**Note:** You can switch the system on and use it for up to an hour without switching the ignition on.

**Note:** You can use the system after you switch the ignition off for up to 10 minutes or until you open a door.

**Note:** For your safety, some features are speed-dependent. Their use is limited to when your vehicle speed is less than 5 km/h (3 mph).

## Using the Touchscreen

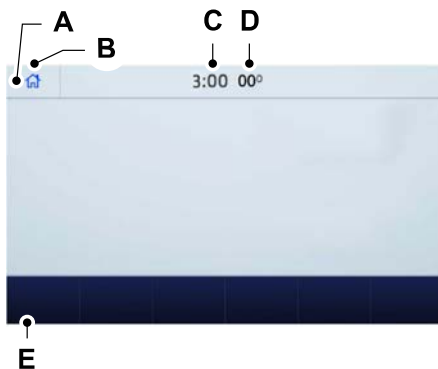

- A Status bar.
- B Home screen.
- C Clock. See **Settings** (page 538).
- D Outside air temperature.
- E Feature bar.

### Status Bar



Cell phone microphone muted.



Audio system muted.



Software update installed.



Wi-Fi connected.



Cell phone roaming.



Text message received.



Emergency Assistance off.



Cell phone network signal strength.



Vehicle data sharing on.



Vehicle location sharing on.



Vehicle data and vehicle location sharing on.



Traffic data source: Live traffic.



Traffic data source: Traffic broadcast.



Wireless charger active.

## Feature Bar



Select to use the radio, a USB, a media player or a Bluetooth device. See **Entertainment** (page 526).



Select to adjust climate settings. See **Climate** (page 528).



Select to make calls and access the phonebook on your cell phone. See **Phone** (page 531).



Select to use the navigation system. See **Navigation** (page 533).



Select to search for and use compatible apps on your iOS or Android device. See **Apps** (page 537).



Select to adjust system settings. See **Settings** (page 538).

## Cleaning the Touchscreen

See **Cleaning Displays and Screens** (page 442).

## Updating the System

### Updating the System Using a USB Drive

#### Downloading an Update

1. Go to the SYNC update page on the local Ford website.
2. Download the update.

**Note:** *The website notifies you if an update is available.*

3. Insert a USB drive into your computer.

**Note:** *The USB drive needs to be empty and meet the minimum requirements detailed on the website.*

4. Follow the instructions provided to download the update to the USB drive.

#### Installing an Update

**Note:** *You can use the system when installation is in progress.*

1. Disconnect all other USB devices from the USB ports.
2. Connect the USB drive with the update to a USB port.

**Note:** *Installation starts automatically within 10 minutes.*

### Updating the System Using a Wi-Fi Network Connection

#### Switching Automatic System Updates On

1. Select **Settings**.
2. Select **Automatic updates**.
3. Switch **Automatic system updates** on.

The system is now set to check for and receive system updates when it is connected to a Wi-Fi network.

**Note:** You can use the system when download is in progress.

**Note:** If the system is disconnected from the Wi-Fi network when download is in progress, the download continues the next time the system is connected to a Wi-Fi network.

## Connecting to a Wi-Fi Network

See **Connecting the Vehicle to a Wi-Fi Network** (page 497).

## Additional Information and Assistance

For additional information and assistance, we recommend that you contact an authorized dealer or refer to the local Ford website.

## USING VOICE RECOGNITION

The system allows you to interact with the entertainment, information and communication systems on your vehicle using voice commands. This allows you to keep your hands on the steering wheel and focus on what is in front of you.



Press the voice control button on the steering wheel and wait for the voice prompt.

**Note:** Press the voice control button again to interrupt a voice prompt and begin speaking.

**Note:** Turn the volume control when a voice prompt plays to adjust the volume.

**Note:** Press and hold the voice control button on the steering wheel to use Siri on your iOS device.

The following voice commands are designed to help you from any screen:

- **List of commands**
- **Help**

The following tables list some of the more frequently used voice commands. For a complete list of voice commands, refer to the local Ford website.

## General

Voice Command	Description
___ list of commands	Get a list of voice commands for a specific feature. <sup>1</sup>
Cancel	Cancel an active voice session.
___ help	Get a list of voice commands for a specific feature. <sup>1</sup>
Back	Return to the previous screen.
Main menu	Go to the main menu.

# SYNC™ 3

Voice Command	Description
Next page	Go to the next page.
Previous page	Go to the previous page.

<sup>1</sup> Add the name of the feature to the command.

## Entertainment

### Audio Source

Voice Command	Description
Radio	Use the radio.
CD Player	Use the CD player.
Bluetooth audio	Use a Bluetooth device.
USB	Use a USB or media player.

### Radio

Voice Command	Description
AM	Listen to AM radio.
___ AM	Tune to a specific AM frequency. <sup>1</sup>
DAB	Listen to DAB radio.
FM	Listen to FM radio.
___ FM	Tune to a specific FM frequency. <sup>1</sup>

<sup>1</sup> Add the radio frequency to two decimal places to the command.

# SYNC™ 3

## USB and Media Player

Voice Command	Description
Play album ___	Play your music by category. <sup>1</sup>
Play artist ___	
Play audiobook ___	
Play genre ___	
Play playlist ___	
Play podcast ___	
Play song ___	
Browse all albums	Browse music on a USB device.
Browse all artists	
Browse all audiobooks	
Browse all genres	
Browse all playlists	
Browse all podcasts	
Browse all tracks	
Browse album ___	Browse your music by category on a USB device. <sup>1</sup>
Browse artist ___	
Browse audiobook ___	
Browse genre ___	
Browse playlist ___	
Browse podcast ___	

<sup>1</sup> Add an album name, artist name, audiobook name, genre name, playlist name, podcast name or track name to the command. Say the name exactly as it appears on your device.

# SYNC™ 3

## Phone

Voice Command	Description
Pair phone	Pair a cell phone or Bluetooth enabled device.
Redial	Redial the last number that you dialed.
Dial ____	Dial a number. <sup>1</sup>
Call ____	Call a specific contact from your phonebook. <sup>2</sup>
Call ____ ____	Call a specific contact from your phonebook at a specific location. <sup>3</sup>
Listen to message	Listen to a text message.
Listen to message ____	Listen to a specific text message from a list of text messages.
Reply to message	Reply to the last text message.

<sup>1</sup> Add the number you want to dial to the command.

<sup>2</sup> Add a contact name from your phonebook to the command. Say the first and last name of your contact exactly as it appears on your device.

<sup>3</sup> Add a contact name and location from your phonebook to the command. Say the first and last name of your contact exactly as it appears on your device.

## Navigation (If Equipped)

### Setting a Destination

Voice Command	Description
Find an address	Enter a destination address. When prompted, provide the house number, the street and city.
Find a POI	Search for a point of interest by name or by category.
Find nearest ___	Search for a nearby point of interest by category. <sup>1</sup>
Find a POI category	Search for a point of interest category. <sup>1</sup>
Destination home	Set your saved home address as your destination.
Destination work	Set your saved place of work as your destination.
Previous destinations	Display and select from a list of previous destinations.
Favourite destinations	Display and select from a list of favorite destinations.

<sup>1</sup> Add a point of interest category or the name of a major brand or chain to the command.

### Route Guidance

Voice Command	Description
Cancel route	Cancel the current route.
Reroute	Select an alternate route.
Repeat last instruction	Repeat the last guidance prompt.
Show route	Display an overview of the route.
Show map	Display the map on the touchscreen.
Show north up	Display a two-dimensional map with north toward the top of the touchscreen.
Show heading up	Display a two-dimensional map with the direction you are traveling toward the top of the touchscreen.
Show 3D	Display a three-dimensional map with the direction you are traveling toward the front.



## Apps

### General

Voice Command	Description
Mobile apps	Start an app. The system prompts your for the app name.
List apps	Get a list of apps running on your device.
Find apps	Search and connect to apps running on your device.

### Active App

Voice Command	Description
___ help	Get a list of voice commands for a specific app. <sup>1</sup>
Close ___	Close an app. <sup>1</sup>

<sup>1</sup>Add an app name to the command.

### Voice Settings

Voice Command	Description
Voice settings	Go to the voice settings menu.
Interaction mode standard	Switch long voice prompts on.
Interaction mode advanced	Switch short voice prompts on.
Call confirmation on	Switch call confirmation on. The system prompts you to confirm before making a call.
Call confirmation off	Switch call confirmation off. The system does not prompt you to confirm before making a call.
Voice command lists on	Switch the display of voice commands on.
Voice command lists off	Switch the display of voice commands off.

## Automatic Blower Motor Speed Reduction

If necessary, the system decreases the blower motor speed when you are using voice commands to reduce the amount of background noise in your vehicle. It returns to normal when you are finished.

## Switching Automatic Blower Motor Speed Reduction Off

Simultaneously press the **A/C** and recirculated air buttons.

## ENTERTAINMENT



Select the audio option on the feature bar.

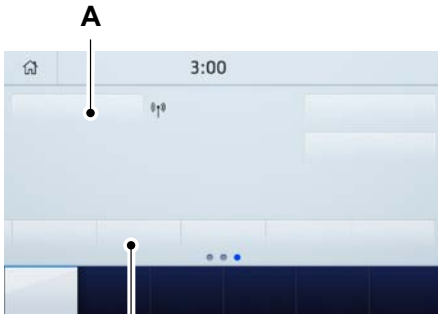

A

B

- A Audio source. Select to choose a different audio source.
- B Presets. Swipe left to view more presets.

You can access these options using the touchscreen or voice commands.

## Using the Radio

### Setting an AM/FM Radio Station

1. Select **Sources**.
2. Select **AM** or **FM**.

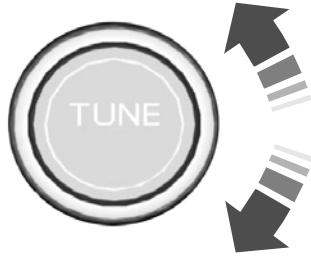

3. Rotate the control to change the frequency.

### Selecting a FM Radio Station From a List

1. Select **Sources**.
2. Select **FM**.
3. Select **Stations**.
4. Select a radio station from the list.

### Selecting a Digital Radio Station From a List

1. Select **Sources**.
2. Select **DAB**.
3. Select **Stations**.
4. Select an ensemble.
5. Select a radio station from the list.

## Manually Changing Digital Radio Stations

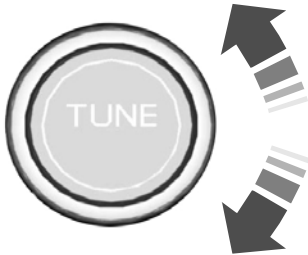

Rotate the control to change the station.

## Automatically Changing Radio Stations



Press to seek the next station up the frequency band.

Press and hold to quickly seek up the frequency band.



Press to seek the next station down the frequency band.

Press and hold to quickly seek down the frequency band.

## Storing a Radio Station

Press and hold one of the preset buttons.

**Note:** The radio briefly mutes to indicate the station has been stored.

**Note:** You can add additional preset pages using the settings option on the feature bar.

## Switching Traffic Announcements On

Select **Traffic (TA)**.

**Note:** If you switch traffic announcements on, traffic announcements broadcast by radio stations interrupt the current audio source to help you plan your route.

## Streaming Music From a Bluetooth Device

Check the compatibility of your device on the local Ford website.

Pair your device. See **Phone** (page 531).

Select **Sources**.



Select Bluetooth.

## Searching for Tracks on a Bluetooth Device

Select **Browse**.

Select a track.

**Note:** Select the cover art to view information about the current track.

## Playing Tracks on a Bluetooth Device in a Random Order



Select to play tracks in a random order.

## Repeating Tracks on a Bluetooth Device



Select the repeat icon to repeat tracks.

**Note:** You can repeat one track or all tracks on an audio format Bluetooth device. You can repeat one track, all tracks or all tracks in one folder on a Bluetooth device.

**Note:** A small number one appears next to the repeat icon to indicate that a track is set to repeat. A small folder icon appears next to it to indicate that a folder is set to repeat.

## Playing Music From a USB or Media Player

Connect your device to a USB port.

Select **Sources**.



Select USB.

**Note:** *The system indexes your music before you can play it.*

## Searching for Tracks on a USB or Media Player

Select **Browse**.

Select a track.

**Note:** *Select the cover art to view information about the current track.*

**Note:** *You can also browse by album, artist, audiobook, genre, playlist, podcast or track name.*

## Playing Tracks on a USB or Media Player in a Random Order



Select to play tracks in a random order.

## Repeating Tracks on a USB or Media Player



Select the repeat icon to repeat tracks.

**Note:** *You can repeat one track or all tracks on an audio format USB or media player. You can repeat one track, all tracks or all tracks in one folder on a USB or media player.*

**Note:** *A small number one appears next to the repeat icon to indicate that a track is set to repeat. A small folder icon appears next to it to indicate that a folder is set to repeat.*

## Supported Devices

The system supports most USB and media players, including iOS and Android devices.

## Supported File Formats

The system supports the following file formats:

- MP3, MP4, WMA, WAV, AAC, AIFF, APE, DSD, and FLAC audio file formats.
- MP3, WMA, WAV, M4A, M4B, AAC, and FLAC file extensions.
- FAT, exFAT, and NTFS file systems.

## Audio File Metadata

The system organizes files on your USB or media player by metadata tags. Metadata tags contain information about the file. If the metadata tags for the files on your USB or media player contain no information, the system classifies them as unknown. The system can index up to 50000 tracks on a USB device or media player, and up to 10 devices.

## CLIMATE

Touch the climate button on the touchscreen to access your climate control features.

**Note:** *You can switch temperature units between Fahrenheit and Celsius. See **Settings** (page 538).*

## Accessing the Climate Control Menu



Touch the button to access additional controls for the front climate system.

## Directing the Airflow



Touch the button to direct airflow to the windshield air vents and de-mister.



Touch the button to direct airflow to the instrument panel air vents.



Touch the button to direct airflow to the footwell air vents.

You can direct air through any combination of these air vents.

## Setting the Blower Motor Speed



Touch up or down to increase or decrease the volume of air that circulates in your vehicle.

## Setting the Temperature

Touch up or down on the left-hand temperature control to set the left-hand temperature.

**Note:** This control also adjusts the right-hand side temperature when you switch off dual zone mode.

Touch up or down on the right-hand temperature control to set the right-hand temperature.

## Switching Auto Mode On and Off



Touch the button to switch on automatic operation, then set the temperature.

The system adjusts the blower motor speed, air distribution, air conditioning operation, and outside or recirculated air to reach and maintain the temperature you have set.

## Switching the Air Conditioning On and Off



A pop-up appears on the screen to display the air conditioning options.

**MAX A/C:** Touch the button to activate and maximize cooling. The driver and passenger temperatures are set to LO, recirculated air flows through the instrument panel vents, air conditioning automatically turns on and the fan automatically adjusts to the highest speed.

**A/C:** Touch to switch the air conditioning on or off. Use A/C with recirculated air to improve cooling performance and efficiency.

**Note:** In certain conditions, such as maximum defrost, the air conditioning compressor may continue to operate even though you switch off the air conditioning.

## Switching the Climate Control On and Off



Touch the button.

## Switching the Climate Controlled Seats On and Off



Touch the button to cycle through the various climate controlled seat settings.

## Switching Dual Zone Mode On and Off



Touch the button to switch on temperature control for the right-hand side of the vehicle.

## Switching the Heated Exterior Mirrors On and Off



Touch the button.

## Switching the Heated Windshield On and Off



Touch the button to clear the windshield of thin ice and fog. The heated windshield turns off after a short period of time.

## Switching the Heated Rear Window On and Off



Touch the button to clear the rear window of thin ice and fog.

## Switching the Heated Seats On and Off



Touch the button to cycle through the various heat settings.

## Switching the Heated Steering Wheel On and Off



Touch the button.

## Switching Maximum Air Conditioning On and Off



Touch the button for maximum cooling.

Recirculated air flows through the instrument panel air vents, air conditioning turns on and the blower motor adjusts to the highest speed.

## Switching Maximum Defrost On and Off



Touch the button for maximum defrosting.

Air flows through the windshield air vents, and the blower motor adjusts to the highest speed.

You can also use this setting to defog and clear the windshield of a thin covering of ice.

**Note:** To prevent window fogging, you cannot select recirculated air when maximum defrost is on.

**Note:** The heated rear window also turns on when you select maximum defrost.

## Switching Recirculated Air On and Off



Touch the button to switch between outside air and recirculated air.

The air currently in the passenger compartment recirculates. This may reduce the time needed to cool the interior, when used with **A/C**, and reduce unwanted odors from entering your vehicle.

**Note:** Recirculated air may turn off, or prevent you from switching on, in all air flow modes except **MAX A/C** to reduce the risk of fogging. Recirculation may also turn on and off in various air distribution control combinations during hot weather to improve cooling efficiency.

## Switching the Ventilated Seats On and Off



Touch the button to cycle through the various ventilated seat settings.

## Accessing Rear Climate Controls



Touch the button to access additional controls for the rear climate system.

## Rear Climate Control Lock Indicator



Touch the button.

# SYNC™ 3

When on, you can only operate the rear passenger settings through the front controls.

## Switching Rear Auto Mode On and Off



Touch the button to switch on rear automatic operation, then set the temperature.

## Switching the Rear Climate Controlled Seats On and Off



Touch the button to cycle through the various climate controlled seat settings.

## Switching the Rear Heated Seats On and Off



Touch the button to cycle through the various heat settings.

## Switching the Rear Ventilated Seats On and Off



Touch the button to cycle through the various ventilated seat settings.

## PHONE



**WARNING:** Driving while distracted can result in loss of vehicle control, crash and injury. We strongly recommend that you use extreme caution when using any device that may take your focus off the road. Your primary responsibility is the safe operation of your vehicle. We recommend against the use of any

hand-held device while driving and encourage the use of voice-operated systems when possible. Make sure you are aware of all applicable local laws that may affect the use of electronic devices while driving.

Check the compatibility of your device on the local Ford website.

## Pairing Your Cell Phone for the First Time

Go to the settings menu on your cell phone and switch Bluetooth on. Make sure your cell phone is discoverable. See your cell phone's user manual.



Select the phone option on the feature bar.

1. Select **Pair phone**.

**Note:** A prompt alerts you to search for your vehicle on your cell phone.

2. Select your vehicle on your cell phone.

**Note:** A number appears on your cell phone and on the touchscreen.

3. Confirm that the number on your cell phone matches the number on the touchscreen.

**Note:** The touchscreen indicates that you have successfully paired your cell phone.

4. Download the phonebook from your cell phone when you are prompted.

**Note:** If you pair more than one cell phone, use the phone settings to specify the primary phone. You can change this setting at any time.

## Using Your Cell Phone

### Recent Call list

Display and select an entry from a list of previous calls.

## Contacts

Display a smart search form to look up your contacts. Use the List button to alphabetically sort your contacts.

## Your phone

Change ring tones, alerts or pair another cell phone.

## Change device

Display the list of paired or connected devices that you can select.

## Do not disturb

Reject incoming calls and switch ring tones and alerts off.

## Phone Keypad

Directly dial a number.

## Text messages

Display the cell phone messages.

## Siri

Connect to Siri on your iOS device.

## Using Text Messaging

Menu Item	Description
Hear it	Hear the text message.
View	View the text message.
Call	Call the sender.
Reply	Reply to the text message with a standard text message.

## Apple CarPlay

1. Connect your device to a USB port.
2. Follow the instructions on the touchscreen.

## Phone Voice Assistant

Connect to the phone voice service on your Android device.

## Text Messaging

### Setting Text Message Notification

#### iOS

1. Go to the settings menu on your cell phone.
2. Select Bluetooth.
3. Select the information icon to the right of your vehicle.
4. Switch text message notification on.

#### Android

1. Go to the settings menu on your cell phone.
2. Select Bluetooth.
3. Select the profiles option.
4. Select the phone profile.
5. Switch text message notification on.

**Note:** *Certain features of the system are not available when you are using Apple CarPlay.*

### Switching Apple CarPlay Off

1. Select **Settings**.
2. Select **Apple CarPlay preferences**.



3. Switch **Apple CarPlay** off.

## Android Auto

1. Connect your device to a USB port.
2. Follow the instructions on the touchscreen.

**Note:** You might need to enable Android Auto from the settings menu.

**Note:** Certain features of the system are not available when you are using Android Auto.

## Switching Android Auto Off

1. Select **Settings**.
2. Select **Android Auto**.
3. Switch **Android Auto** off.

## NAVIGATION

**Note:** For more information, refer to the local Ford website.



Select the navigation option on the feature bar.

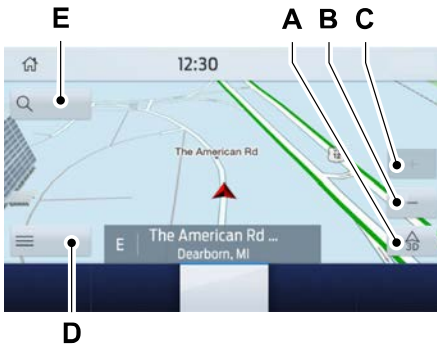

- A Map view menu.
- B Zoom out.

- C Zoom in.
- D Route guidance menu.
- E Destination entry menu.

## Setting a Destination

### Setting a Destination Using the Text Entry Screen

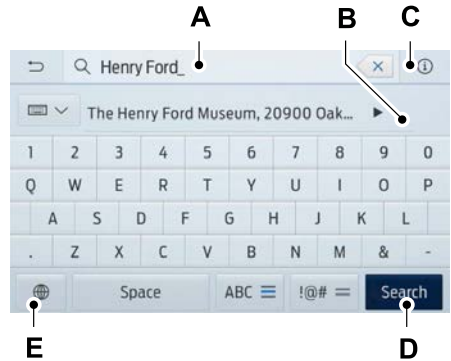

- A Text entry field.
- B Automatic suggestions based on the text you enter.
- C Information icon.
- D Search.
- E Keyboard settings.

**Note:** Select one of the suggestions to copy the detail to the text entry field.

**Note:** You can enter a destination in a number of formats, **city street number, city number street**, zip code or point of interest.

**Note:** You do not have to enter the destination country.

**Note:** To enter mutated vowels or accented characters, for example **ã** or **é**, press and hold the corresponding character on the keyboard.

Select **Search**.

Select **Start** to begin route guidance.

## Setting a Destination Using the Map Screen

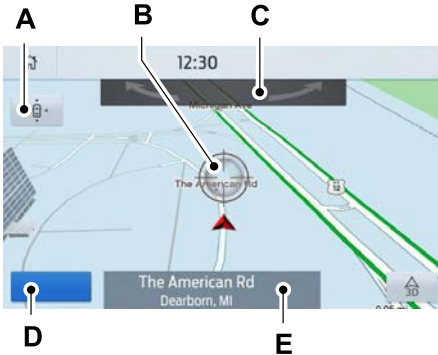

- A Re-center the map.
- B Selected location.
- C 3D map rotation. Swipe left or right.
- D Start route guidance.
- E Destination name.

Select the location on the map.

Select **Start** to begin route guidance.

## Changing the Format of the Map

Display the map in one of the following formats:

- A two-dimensional map with the direction you are traveling toward the top of the screen.
- A two-dimensional map with north toward the top of the screen.
- A three-dimensional map with the direction you are traveling toward the front.

## Zoom

Display more or less detail on the map.

**Note:** You can use pinch gestures to zoom in and out. Place two fingers on the screen and move them apart to zoom in. Place two fingers on the screen and bring them together to zoom out.

## Route Guidance

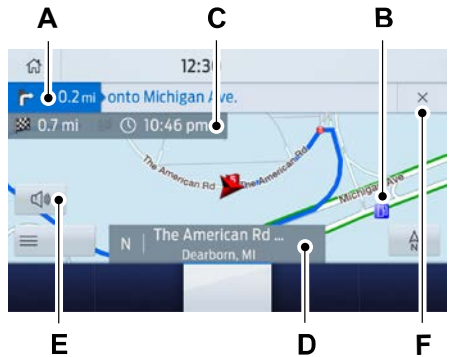

- A Turn indicator. Select to hear the last guidance prompt.
- B Point of interest.
- C Estimated time of arrival, distance to destination or time to destination.
- D Current road.
- E Mute guidance prompts.
- F Cancel route guidance.

**Note:** To change guidance prompt volume, turn the volume control when a guidance prompt plays.

# SYNC™ 3

## Route Guidance Menu

Menu Item	Description
Screen view	Adjust your map preferences for when route guidance is active.
Full map	View a full screen map when route guidance is active.
Motorway exit info	View exit information for your current route.
Turn list	View the turn list for your current route. Select a road to avoid it.
Traffic list	View traffic nearby or on your current route. <sup>1</sup>
Navigation settings	Adjust navigation settings.
Where am I?	View information about your current location.
Cancel route	Cancel route guidance.
Show route	View the entire current route on the map.
Re-route	View an alternative route compared to your current one.
Edit waypoints	Change the order or remove waypoints.
Optimise order	The system determines the order of waypoints for you.
Start	Go to the next screen and start the new route.
Search	Enter a destination address.
Home	Set your saved home address as your destination
Work	Set your saved place of work as your destination.
Favourites	Display and select from a list of favorite destinations.
Previous destinations	Display and select from a list of previous destinations.
POI	Display the point of interest categories.

<sup>1</sup> Reliant upon traffic message channel or live traffic.

### Adjusting the Guidance Prompt Volume

Turn the volume control when a guidance prompt plays to adjust the volume.

**Note:** *If you have inadvertently adjusted the volume to zero, press the turn indicator button to play the last voice prompt and then adjust the volume to the desired level.*

## Muting Guidance Prompts



Select the mute option on the screen to mute guidance prompts.

**Note:** The system mutes the next and all future guidance prompts.

## Adding Waypoints

You can add a waypoint to a navigation route as a destination along your route. You can add up to five waypoints.

1. Select the search option on the map.
2. Set a destination.
3. Select the flag icon.
4. Select **Start**.

## Canceling Route Guidance

### Canceling Route Guidance From the Route Guidance Menu



Select the route guidance menu option on the active guidance screen.

Select **Cancel route**.

### Canceling Route Guidance From the Main Map



Select the icon in the upper right-hand corner of the main map to cancel route guidance.

## Live Traffic (If Equipped)

Live traffic provides near real-time traffic information to help you plan the fastest route to your destination. You must have an active subscription for Live Traffic.

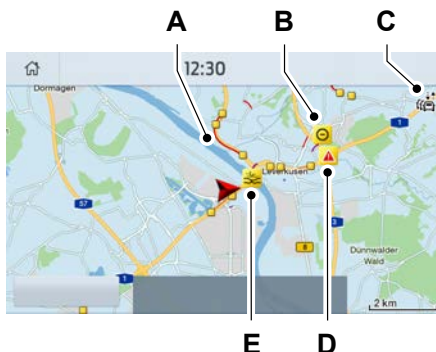

- A Traffic congestion.
- B Road closure.
- C Live traffic active.
- D Urgent warning.
- E Traffic incident.

## Switching Live Traffic On

**Note:** Make sure that the modem is enabled. See **Connected Vehicle** (page 497).

1. Select **Settings**.
2. Select **FordPass Connect**.
3. Select **Connectivity settings**.
4. Switch **Vehicle connectivity** on.
5. Switch **Location** on.
6. Switch **Vehicle data & Remote ctrl** on.
7. Switch **Live Traffic** on.

## Navigation Map Updates

Please check the local Ford website or contact your dealership for navigation map updates.

HERE is the digital map provider for the navigation application. If you find map data errors, you can report them directly to HERE by visiting [www.here.com](http://www.here.com). HERE evaluates all reported map errors and responds with the result of their investigation by e-mail.

## APPS

**Note:** For more information about available apps, supported devices and troubleshooting, refer to our local website.

When you start an app through the system for the first time, you could be asked to grant certain permissions. You can review and change the permissions that you have granted at any time when your vehicle is not moving. See **Settings** (page 538).

**Note:** We recommend that you check your data plan before using your apps through the system. Using them could result in additional charges.

**Note:** We recommend that you check the app provider's terms and conditions and privacy policy before using their app.

**Note:** Make sure that you have an active account for apps that you want to use through the system.

**Note:** Some apps will work with no setup. Others require you to configure some personal settings before you can use them.

## Using Apps on an iOS Device



Select the apps option on the feature bar.

1. If your device is connected via USB, switch Apple CarPlay off. See **Phone** (page 531).
2. Connect your device to a USB port or pair and connect using Bluetooth.
3. If prompted to enable CarPlay, select **Disable**.

4. Start the apps on your device that you want to use through SYNC.

**Note:** If you close the apps on your device, you will not be able to use them through the system.

5. Select the app that you want to use on the touchscreen.

**Note:** Connect your device to a USB port if you want to use a navigation app. When using a navigation app, keep your device unlocked and the app open.

## Using Apps on an Android Device



Select the apps option on the feature bar.

1. If your device is connected via USB, switch Android Auto off. See **Phone** (page 531).
2. Switch on **Enable Mobile apps via USB** in the Mobile Apps Settings tile.
3. Pair your device. See **Phone** (page 531).
4. Start the apps on your device that you want to use through SYNC.

**Note:** If you close the apps on your device, you will not be able to use them through the system.

5. Select **Find mobile apps**.

**Note:** The system searches and connects to compatible apps that are running on your device.

6. Select the app that you want to use on the touchscreen.

**Note:** Mobile Apps on your device use the USB port to establish a connection with SYNC. Some devices may lose the ability to play music over USB when Mobile Apps are enabled.

## Using Mobile Navigation on an Android Device

1. Connect your device to a USB port.

2. Switch Android Auto off. See **Phone** (page 531).
3. Switch on **Enable Mobile apps via USB** in the Mobile Apps Settings tile.
4. Select the apps option on the feature bar.
5. Select the navigation app that you want to use on the touchscreen.

**Note:** *When using a navigation app, keep your device unlocked and the app open.*

**Note:** *Mobile Apps on your device use the USB port to establish a connection with SYNC. Some devices may lose the ability to play music over USB when Mobile Apps are enabled.*

## SETTINGS



Select the settings option on the feature bar.

Select a tile to access the settings.



Select the option to display extra information.

### Ambient Lighting

You can adjust the ambient lighting settings.

### Android Auto

You can switch Android Auto on and off.

### Apple CarPlay

You can switch Apple CarPlay on and off.

### Audio

You can adjust the audio settings.

### Automatic Updates

You can switch automatic updates on and off and adjust the settings.

### Bluetooth

You can switch Bluetooth on and off and pair your cell phone.

### Clock

You can adjust the clock settings.

### Display

You can adjust display settings like brightness and auto dim.

### Emergency Assistance

You can switch Emergency Assistance on and off.

### FordPass

You can adjust the FordPass settings.

### General

You can adjust settings like language, measurement units, or reset the system.

### Mobile Apps

You can adjust permissions, enable, disable, and update mobile apps.

### Navigation (If Equipped)

You can adjust navigation settings like map preferences and route guidance.

### Phone

You can connect and disconnect your device, or manage the connected device settings.

### Seats (If Equipped)

You can adjust the position and the massage function of the seats.

### Sound

You can adjust the sound settings.

# SYNC™ 3

---

## **Valet Mode (If Equipped)**

You can enable and disable the valet mode.

## **Vehicle (If Equipped)**

You can adjust the camera settings.

## **Voice Control**

You can adjust the voice control settings.

## **Wi-Fi**

You can switch Wi-Fi on and off and adjust the settings.

## SYNC™ 3 TROUBLESHOOTING

### Voice Recognition

Symptom	Possible Cause and Resolution
The system does not understand what I am saying.	<ul style="list-style-type: none"> <li>– You are using the wrong voice commands.                             <ul style="list-style-type: none"> <li>• See <b>Using Voice Recognition</b> (page 520).</li> <li>• For a complete list of voice commands, refer to the local Ford website.</li> </ul> </li> <li>– You are speaking too soon.                             <ul style="list-style-type: none"> <li>• Wait for the voice prompt before you speak.</li> </ul> </li> </ul>
The system does not understand the name of a track or artist.	<ul style="list-style-type: none"> <li>– Device limitation. Bluetooth does not support voice commands.                             <ul style="list-style-type: none"> <li>• Connect your device to a USB port.</li> <li>• If you have an iOS device, press and hold the voice control button on the steering wheel to use Siri to play specific tracks.</li> </ul> </li> <li>– You are using the wrong voice commands.                             <ul style="list-style-type: none"> <li>• See <b>Using Voice Recognition</b> (page 520).</li> <li>• For a complete list of voice commands, refer to the local Ford website.</li> </ul> </li> <li>– You are not saying the name exactly as it appears on your device.                             <ul style="list-style-type: none"> <li>• Say the name of the track or artist exactly as it appears on your device. Spell out any abbreviations in the name.</li> </ul> <p>The song or artist name may have some special characters that are not being recognized by the system.</p> </li> <li>– The name contains special characters, for example *, - or +.                             <ul style="list-style-type: none"> <li>• Rename the files on your device or use the touch-screen to select and play the track.</li> </ul> </li> </ul>



# SYNC™ 3

Symptom	Possible Cause and Resolution
<p>The system does not understand the name of a contact in the phonebook on my device and calls the wrong contact.</p>	<ul style="list-style-type: none"> <li>- You are not saying the name exactly as it appears on your device.               <ul style="list-style-type: none"> <li>• Say the first and last name of the contact exactly as it appears on your device. Spell out any abbreviations in the name.</li> </ul> </li> <li>- The name contains special characters, for example *, - or +.               <ul style="list-style-type: none"> <li>• Rename the contact on your device or use the touchscreen to select and call the contact.</li> </ul> </li> </ul>
<p>The system does not understand foreign names of contacts in the phonebook on my device.</p>	<ul style="list-style-type: none"> <li>- You are not saying the name exactly as it appears on your device.               <ul style="list-style-type: none"> <li>• Say the first and last name of the contact exactly as it appears on your device. The system applies phonetic pronunciation rules of the selected language to the names of contacts in the phonebook on your device. Select the name of the contact on the touchscreen and use the Hear it option to get an idea of how the system expects you to pronounce it.</li> </ul> </li> </ul>
<p>The system voice prompts and the pronunciation of some words does not seem to be very accurate.</p>	<ul style="list-style-type: none"> <li>- Device limitation.               <ul style="list-style-type: none"> <li>• The system uses text-to-speech technology and uses a synthetically generated voice rather than pre-recorded human voice.</li> </ul> </li> </ul>

## USB and Bluetooth Audio

Symptom	Possible Cause and Resolution
<p>I cannot connect my device.</p>	<ul style="list-style-type: none"> <li>- Device malfunction.               <ul style="list-style-type: none"> <li>• Disconnect your device. Switch your device off, reset it and try again.</li> </ul> </li> <li>- Cable connection issue.               <ul style="list-style-type: none"> <li>• Correctly connect the cable to your device and the vehicle USB port.</li> </ul> </li> <li>- Incompatible cable.               <ul style="list-style-type: none"> <li>• Use the cable recommended by the manufacturer of your device.</li> </ul> </li> </ul>

# SYNC™ 3

Symptom	Possible Cause and Resolution
	<ul style="list-style-type: none"> <li>- Incorrect device settings.               <ul style="list-style-type: none"> <li>• Make sure that your device does not have an auto-install program or active security settings.</li> <li>• Check that your device is not set only to charge.</li> </ul> </li> <li>- Device lock screen enabled.               <ul style="list-style-type: none"> <li>• Unlock your device before connecting it.</li> </ul> </li> </ul>
The system does not recognize my device.	<ul style="list-style-type: none"> <li>- Device limitation.               <ul style="list-style-type: none"> <li>• Do not leave your device in your vehicle during very hot or very cold weather conditions.</li> </ul> </li> </ul>
The system does not understand the name of a track or artist.	<ul style="list-style-type: none"> <li>- Device limitation. Bluetooth does not support voice commands.               <ul style="list-style-type: none"> <li>• Connect your device to a USB port.</li> <li>• If you have an iOS device, press and hold the voice control button on the steering wheel to use Siri to play specific tracks.</li> </ul> </li> </ul>
I cannot stream audio from my Bluetooth device.	<ul style="list-style-type: none"> <li>- Incompatible device.               <ul style="list-style-type: none"> <li>• Check the compatibility of your device on the local Ford website.</li> </ul> </li> <li>- Device not connected.               <ul style="list-style-type: none"> <li>• Pair your device. See <b>Phone</b> (page 531).</li> </ul> </li> <li>- Media player not running.               <ul style="list-style-type: none"> <li>• Start the media player on your device.</li> </ul> </li> </ul>
The system does not recognize the music on my device.	<ul style="list-style-type: none"> <li>- Missing or incorrect audio file metadata, for example artist, song title, album or genre.               <ul style="list-style-type: none"> <li>• Repair the files on your device.</li> </ul> </li> <li>- Corrupt files.               <ul style="list-style-type: none"> <li>• Repair the files on your device.</li> </ul> </li> <li>- Copyright protected files.               <ul style="list-style-type: none"> <li>• Use a device that contains files that are not copyright protected.</li> </ul> </li> <li>- Unsupported file format.               <ul style="list-style-type: none"> <li>• Repair or convert the files to a supported format. See <b>Entertainment</b> (page 526).</li> </ul> </li> </ul>

# SYNC™ 3

Symptom	Possible Cause and Resolution
	<ul style="list-style-type: none"> <li>– Device indexing required.               <ul style="list-style-type: none"> <li>• Re-index your device. See <b>Settings</b> (page 538).</li> </ul> </li> <li>– Device lock screen enabled.               <ul style="list-style-type: none"> <li>• Unlock your device before connecting it.</li> </ul> </li> </ul>
Sometimes I cannot hear a track playing on my device.	<ul style="list-style-type: none"> <li>– Device malfunction.               <ul style="list-style-type: none"> <li>• Disconnect your device. Switch your device off, reset it and try again.</li> </ul> </li> </ul>
When I disconnect my iOS device the audio volume is set to maximum.	<ul style="list-style-type: none"> <li>– Device limitation.               <ul style="list-style-type: none"> <li>• Turn the volume down on your device</li> </ul> </li> </ul>
The system does not play the tracks on my USB drive in the correct order.	<p>If the system does not play the tracks on your USB device in the correct order, the following information could help:</p> <ul style="list-style-type: none"> <li>– If you are selecting USB as the audio source when the system is still indexing, SYNC plays tracks sorted alphabetically by file name in the root directory.</li> <li>– If you are selecting USB as the audio source after the system has finished indexing, SYNC plays all tracks sorted alphabetically by the title in the ID3 tag regardless of where they are located. SYNC uses the file name if the title in the ID3 Tag does not exist.</li> <li>– If you are selecting the option to play all tracks from the browsing menu, SYNC plays all tracks sorted alphabetically by the title in the ID3 tag regardless of where they are located. SYNC uses the file name if the title in the ID3 Tag does not exist.</li> <li>– If you are selecting a track when using the explore device option, SYNC plays tracks sorted alphabetically by file name in the folder you have selected. SYNC then plays all tracks in any subfolders in the folder you have selected.</li> </ul>

## Phone

Symptom	Possible Cause and Resolution
During a call, I can hear excessive background noise.	<ul style="list-style-type: none"> <li>– Incorrect cell phone settings.                             <ul style="list-style-type: none"> <li>• Check and adjust the audio settings on your cell phone. Refer to your cell phone's user manual.</li> </ul> </li> </ul>
During a call, I can hear the other person but they cannot hear me.	<ul style="list-style-type: none"> <li>– Cell phone malfunction.                             <ul style="list-style-type: none"> <li>• Switch your cell phone off, reset it and try again.</li> </ul> </li> <li>– Cell phone microphone muted.                             <ul style="list-style-type: none"> <li>• Unmute your cell phone microphone.</li> </ul> </li> </ul>
During a call, I cannot hear the other person and they cannot hear me.	<ul style="list-style-type: none"> <li>– System restart required.                             <ul style="list-style-type: none"> <li>• Restart the system. Switch the ignition off and open the door. Close the door and lock the vehicle. Wait until the touchscreen is off and any illuminated USB ports are not illuminated. Unlock the vehicle, switch the ignition on and try again.</li> </ul> </li> </ul>
I cannot download phonebook.	<ul style="list-style-type: none"> <li>– Incompatible cell phone.                             <ul style="list-style-type: none"> <li>• Check the compatibility of your cell phone on the local Ford website.</li> </ul> </li> <li>– Incorrect cell phone settings.                             <ul style="list-style-type: none"> <li>• Allow the system to retrieve contacts from your cell phone. Refer to your cell phone's user manual.</li> </ul> </li> <li>– Incorrect system settings.                             <ul style="list-style-type: none"> <li>• Switch automatic phonebook download on. See <b>Settings</b> (page 538).</li> </ul> </li> <li>– Cell phone malfunction.                             <ul style="list-style-type: none"> <li>• Switch your cell phone off, reset it and try again.</li> </ul> </li> </ul>
A message displays suggesting that my phonebook has downloaded but it is empty or it has missing contacts.	<ul style="list-style-type: none"> <li>– Incorrect cell phone settings.                             <ul style="list-style-type: none"> <li>• Allow the system to retrieve contacts from your cell phone. Refer to your cell phone's user manual.</li> <li>• Check the location of the missing contacts on your cell phone. If they are stored on the SIM card, move them to the cell phone memory.</li> </ul> </li> <li>– Incorrect system settings.                             <ul style="list-style-type: none"> <li>• Switch automatic phonebook download on. See <b>Settings</b> (page 538).</li> </ul> </li> </ul>

# SYNC™ 3

Symptom	Possible Cause and Resolution
I cannot connect my cell phone.	<ul style="list-style-type: none"> <li>– Incompatible cell phone. <ul style="list-style-type: none"> <li>• Check the compatibility of your cell phone on the local Ford website.</li> </ul> </li> <li>– Cell phone malfunction. <ul style="list-style-type: none"> <li>• Switch your cell phone off, reset it and try again.</li> <li>• Install the latest cell phone firmware.</li> <li>• Delete your device from system and delete SYNC from your device and try again.</li> <li>• Switch automatic phonebook download off. See <b>Settings</b> (page 538).</li> </ul> </li> </ul>
Text messaging does not work.	<ul style="list-style-type: none"> <li>– Incompatible cell phone. <ul style="list-style-type: none"> <li>• Check the compatibility of your cell phone on the local Ford website.</li> </ul> </li> <li>– Cell phone malfunction. <ul style="list-style-type: none"> <li>• Switch your cell phone off, reset it and try again.</li> </ul> </li> </ul>
I cannot hear text messages.	<ul style="list-style-type: none"> <li>– Incompatible cell phone. <ul style="list-style-type: none"> <li>• Check the compatibility of your cell phone on the local Ford website.</li> </ul> </li> </ul>

## Navigation (if Equipped)

Symptom	Possible Cause and Resolution
I cannot enter a street name when I am abroad.	<ul style="list-style-type: none"> <li>– Incorrect entry method. <ul style="list-style-type: none"> <li>• Enter the street name with the country.</li> </ul> </li> </ul>
The system does not recognize coordinates.	<ul style="list-style-type: none"> <li>– You are using the wrong coordinates format. <ul style="list-style-type: none"> <li>• Use the format ##. #####, ##. ##### (for N/S, E/W). Add a minus before coordinates if the direction is West and keep a positive value if the direction is East, for example 12.5412 means East and -12.5412 means West.</li> </ul> </li> </ul>

# SYNC™ 3

## Apps

Symptom	Possible Cause and Resolution
The system cannot find any apps.	<ul style="list-style-type: none"> <li>- Incompatible device.               <ul style="list-style-type: none"> <li>• You need an Android device with OS 4.3 or higher or an iOS device with iOS 8.0 or higher. Pair and connect your Android device to find AppLink compatible apps. Connect your Android or iOS device to a USB port or pair and connect using Bluetooth.</li> </ul> </li> </ul>
I have a compatible device and it is correctly connected but the system still cannot find any apps.	<ul style="list-style-type: none"> <li>- AppLink compatible apps not installed on your device.               <ul style="list-style-type: none"> <li>• Download and install the latest version of the app.</li> </ul> </li> <li>- AppLink compatible apps not running on your device.               <ul style="list-style-type: none"> <li>• Start the apps to allow the system to find them and make sure you sign in to any apps if required.</li> </ul> </li> <li>- Incorrect app settings.               <ul style="list-style-type: none"> <li>• Check and adjust the app settings on your device and allow SYNC to access the app if required.</li> </ul> </li> </ul>
I have a compatible device, it is correctly connected and my apps are running but the system still cannot find any apps.	<ul style="list-style-type: none"> <li>- Apps failed to fully close.               <ul style="list-style-type: none"> <li>• Restart the apps and try again.</li> <li>• If you have an Android device with apps that have an exit or quit option, use this and then restart the apps. Alternatively, use the force stop option in the settings menu on your device.</li> <li>• If you have an iOS device with iOS 7.0 or higher, tap the home button on your device twice and then swipe the app upward to close it.</li> </ul> </li> </ul>
I have an Android device that is correctly connected, I have restarted my apps and they are running but the system still cannot find them.	<ul style="list-style-type: none"> <li>- An issue on some older versions of the Android operating system could result in apps not being found.               <ul style="list-style-type: none"> <li>• Switch Bluetooth off and on again to force the system to reconnect to your device.</li> </ul> </li> </ul>

# SYNC™ 3

<b>Symptom</b>	<b>Possible Cause and Resolution</b>
I have an iOS device that is correctly connected, I have restarted my apps and they are running but the system still cannot find them.	<ul style="list-style-type: none"><li>- Cable connection issue.<ul style="list-style-type: none"><li>• Disconnect the cable from your device, wait for a moment and then connect it again to force the system to reconnect to your device.</li></ul></li></ul>
I have an Android device running a media app which the system has found but I cannot hear the sound or the sound is very quiet.	<ul style="list-style-type: none"><li>- Device volume is low.<ul style="list-style-type: none"><li>• Turn the volume up on your device.</li></ul></li></ul>
I have an Android device running a number of compatible apps but the system cannot find all of them.	<ul style="list-style-type: none"><li>- Device limitation. Some Android devices have a limited number of Bluetooth ports that apps can use to connect. If you have more apps running on your device than the number of available Bluetooth ports, the system cannot find all of them.<ul style="list-style-type: none"><li>• Close some of the apps to allow the system to find those that you want to use.</li></ul></li></ul>

## Wi-Fi Connectivity

Symptom	Possible Cause and Resolution
I cannot connect to a Wi-Fi network.	<ul style="list-style-type: none"> <li>– Password error.               <ul style="list-style-type: none"> <li>• Enter the correct network password.</li> </ul> </li> <li>– Weak network signal.               <ul style="list-style-type: none"> <li>• Move your vehicle closer to the Wi-Fi hotspot or to a place where the network signal is not obstructed.</li> </ul> </li> <li>– Multiple access points in range with the same SSID.               <ul style="list-style-type: none"> <li>• Use a unique name for your SSID. Do not use the default name unless it contains a unique identifier, for example as part of the MAC address.</li> </ul> </li> </ul>
The Wi-Fi connection disconnects after successful connection.	<ul style="list-style-type: none"> <li>– Weak network signal.               <ul style="list-style-type: none"> <li>• Move your vehicle closer to the Wi-Fi hotspot or to a place where the network signal is not obstructed.</li> </ul> </li> </ul>
I am close to a Wi-Fi hotspot but the network signal strength is weak.	<ul style="list-style-type: none"> <li>– Obstructed network signal.               <ul style="list-style-type: none"> <li>• If your vehicle has a heated windshield, position your vehicle so that the windshield is not facing the Wi-Fi hotspot.</li> <li>• If your vehicle has metallic tinting on the windows but not on the windshield, position your vehicle so that the windshield is facing the Wi-Fi hotspot or open the windows that are facing the hotspot.</li> <li>• If your vehicle has metallic tinting on the windows and the windshield, open the windows that are facing the hotspot.</li> <li>• If your vehicle is in a garage and you have the garage door closed, open the garage door.</li> </ul> </li> </ul>



# SYNC™ 3

Symptom	Possible Cause and Resolution
I cannot see a network in the list of available networks that I expect to see.	<ul style="list-style-type: none"><li>– Hidden network.<ul style="list-style-type: none"><li>• Make the network visible and try again.</li></ul></li></ul>
Software downloads take too long.	<ul style="list-style-type: none"><li>– Weak network signal<ul style="list-style-type: none"><li>• Move your vehicle closer to the Wi-Fi hotspot or to a place where the network signal is not obstructed.</li></ul></li><li>– Wi-Fi hotspot in high demand or has a slow Internet connection.<ul style="list-style-type: none"><li>• Use a more reliable Wi-Fi hotspot.</li></ul></li></ul>
The system seems to connect to a Wi-Fi network and the signal strength is excellent but the software does not update.	<ul style="list-style-type: none"><li>– No software update available.</li><li>– Wi-Fi network requires a subscription or acceptance of terms and conditions.<ul style="list-style-type: none"><li>• Test the connection using another device. If the network requires a subscription or acceptance of terms and conditions, contact the network service provider.</li></ul></li></ul>

## Resetting the System

1. Simultaneously press and hold the seek up and the audio unit power buttons until the screen goes black.
2. Wait three minutes to allow the system to complete the reset.
3. Press the audio unit power button to switch the system on.

**Note:** *You can reset the system to restore functionality that has stopped working. The system reset is designed to restore functionality and not delete any data that you have stored.*

## Additional Information and Assistance

For additional information and assistance, we recommend that you contact an authorized dealer or refer to the local Ford website.

# Appendices

## ELECTROMAGNETIC COMPATIBILITY



**WARNING:** Do not place objects or mount equipment on or near the airbag cover, on the side of the front or rear seatbacks, or in areas that may come into contact with a deploying airbag. Failure to follow these instructions may increase the risk of personal injury in the event of a crash.



**WARNING:** Do not fasten antenna cables to vehicle wiring, fuel pipes and brake pipes.



**WARNING:** Keep antenna and power cables at least 10 cm (4 in) from any electronic modules and airbags.

**Note:** We test and certify your vehicle to meet electromagnetic compatibility legislation. It is your responsibility to make sure that any equipment an authorized dealer installs on your vehicle complies with applicable local legislation and other requirements. Installation of some aftermarket electronic devices could degrade the performance of vehicle functions, which use radio frequency signals such as broadcast radio receiver, tire pressure monitoring system, push button start, **Bluetooth®** connectivity or satellite navigation.

**Note:** Any radio frequency transmitter equipment in your vehicle (such as cellular telephones and amateur radio transmitters) must keep to the parameters in the following illustrations and table. We do not provide any other special provisions or conditions for installations or use.

### Car/SUV

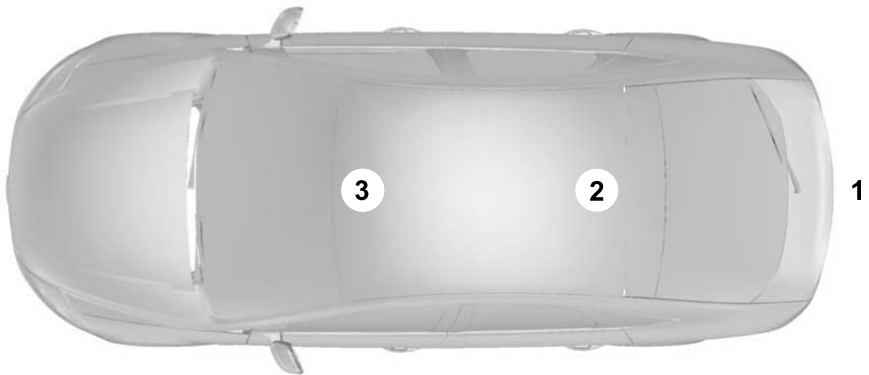

# Appendices

---

## Van

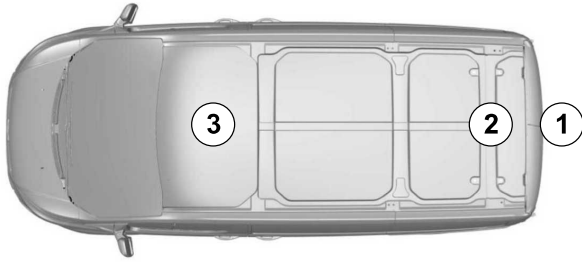

## Truck

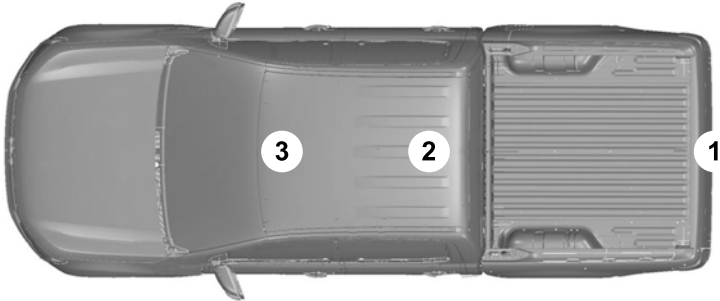

# Appendices

---

<b>Frequency Band MHz</b>	<b>Maximum output power Watt (Peak RMS)</b>	<b>Antenna Positions</b>
1-30	50	1
50-54	50	2, 3
68-88	50	2, 3
142-176	50	2, 3
380-512	50	2, 3
806-870	10	2, 3

# Appendices

---

## ECALL USER INFORMATION

### eCall User Information According to Regulation (EU) 2017/78, Annex I, Part 3

#### 1 DESCRIPTION OF THE ECALL IN-VEHICLE SYSTEM

- 1.1. Overview of the 112-based eCall in-vehicle system, its operation and functionalities: See **What is eCall** (page 60).
- 1.2. The 112-based eCall service is a public service of general interest and is accessible free of charge.
- 1.3. The 112-based eCall in-vehicle system is activated by default. It is activated automatically by means of in-vehicle sensors in the event of a severe accident. It will also be triggered automatically when the vehicle is equipped with a TPS system which does not function in the event of a severe accident.
- 1.4. The 112-based eCall in-vehicle system can also be triggered manually, if needed. Instructions for manual activation of the system: See **Manually Making an Emergency Call** (page 60).
- 1.5. In the event of a critical system failure that would disable the 112-based eCall in-vehicle system, the following warning will be given to the occupants of the vehicle: See **Emergency Call Indicators** (page 61).

#### 2 INFORMATION ON DATA PROCESSING

- 2.1. Any processing of personal data through the 112-based eCall in-vehicle system shall comply with the personal data protection rules provided for in Directives 95/46/EC (1) and 2002/58/EC (2) of the European Parliament and of the Council, and in particular, shall be based on the necessity to protect the vital interests of the individuals in accordance with Article 7(d) of Directive 95/46/EC (3).
- 2.2. Processing of such data is strictly limited to the purpose of handling the emergency eCall to the single European emergency number 112.
- 2.3. Types of data and its recipients.
- 2.3.1. The 112-based eCall in-vehicle system may collect and process only the following data:
  - Vehicle Identification Number.
  - Vehicle type (passenger vehicle or light commercial vehicle).
  - Vehicle propulsion storage type (gasoline/diesel/CNG/LPG/electric/hydrogen).
  - Vehicle last three locations and direction of travel.

# Appendices

---

- Log file of the automatic activation of the system and its timestamp.
  - Any additional data (if applicable): -
- 2.3.2. Recipients of data processed by the 112-based eCall in-vehicle system are the relevant public safety answering points designated by the respective public authorities of the country on which territory they are located, to first receive and handle eCalls to the single European emergency number 112.  
Additional information (if available): -
- 2.4. Arrangements for data processing.
- 2.4.1. The 112-based eCall in-vehicle system is designed in such a way as to ensure that the data contained in the system memory is not available outside the system before an eCall is triggered.  
Additional remarks (if any): -
- 2.4.2. The 112-based eCall in-vehicle system is designed in such a way as to ensure that it is not traceable and not subject to any constant tracking in its normal operation status.  
Additional remarks (if any): -
- 2.4.3. The 112-based eCall in-vehicle system is designed in such a way as to ensure that data in the system internal memory is automatically and continuously removed.
- 2.4.3.1. The vehicle location data is constantly overwritten in the internal memory of the system so as always to keep maximum of the last three up-to-date locations of the vehicle necessary for the normal functioning of the system.
- 2.4.3.2. The log of activity data in the 112-based eCall in-vehicle system is kept for no longer than necessary for attaining the purpose of handling the emergency eCall and in any case not beyond 13 hours from the moment an emergency eCall was initiated.  
Additional remarks (if any): -
- 2.5. Modalities for exercising data subject's rights.
- 2.5.1. The data subject (the vehicle's owner) has a right of access to data and as appropriate to request the rectification, erasure or blocking of data, concerning him or her, the processing of which does not comply with the provisions of Directive 95/46/EC. Any third parties to whom the data have been disclosed have to be notified of such rectification, erasure or blocking carried out in compliance with this Directive, unless it proves impossible or involves a disproportionate effort.
- 2.5.2. The data subject has a right to complain to the competent data protection authority if he or she considers that his or her rights have been infringed as a result of the processing of his or her personal data.

# Appendices

---

- 2.5.3. Contact service responsible for handling access requests (if any): Contact the data protection officer of your local Public Safety Answering Point.
- (1) Directive 95/46/EC of the European Parliament and of the Council of 24 October 1995 on the protection of individuals with regard to the processing of personal data and on the free movement of such data (OJ L 281, 23.11.1995, p. 31).
  - (2) Directive 2002/58/EC of the European Parliament and of the Council of 12 July 2002 concerning the processing of personal data and the protection of privacy in the electronic communications sector (Directive on privacy and electronic communications) (OJ L 201, 31.7.2002, p. 37).
  - (3) Directive 95/46/EC is repealed by Regulation (EU) 2016/679 of the European Parliament and of the Council of 27 April 2016 on the protection of natural persons with regard to the processing of personal data and on the free movement of such data (General Data Protection Regulation) (OJ L 119, 4.5.2016, p. 1). The Regulation applies from 25 May 2018.

## **3 INFORMATION ON THIRD PARTY SERVICES AND OTHER ADDED VALUE SERVICES (IF FITTED)**

- 3.1. Description of the operation and the functionalities of the TPS system/added value service: Your vehicle may be equipped with a modem that allows for emergency calls (eCall), automatic software updates and other services. See the information in this Owner's Manual or in the FordPass app for a description of these services. We provide a 112-based eCall in-vehicle system and we do not provide a TPS eCall system.
- 3.2. Any processing of personal data through the TPS system/other added value service shall comply with the personal data protection rules provided for in Directives 95/46/EC and 2002/58/EC.
  - 3.2.1. Legal basis for the use of TPS system and/or added value services and for processing data through them: For information on the legal bases for processing of personal data through added value services, review the data privacy information for any services to which you subscribe. This privacy information can be found in the FordPass app or on the local Ford website.
- 3.3. The TPS system and/or other added value services shall process personal data only on the base of the explicit consent of the data subject (the vehicle's owner or owners).

# Appendices

---

- 3.4. Modalities for data processing through TPS system and/or other added value services, including any necessary additional information regarding traceability, tracking and processing of personal data: See the privacy information in the FordPass app or on the local Ford website.
- 3.5. The owner of a vehicle equipped with a TPS eCall system and/or other added value service in addition to the 112-based eCall in-vehicle system has the right to choose to use the 112-based eCall in-vehicle system rather than the TPS eCall system and the other added value service.
- 3.5.1. Contact details for handling TPS eCall system deactivation requests: You can have all added value services deactivated except for eCall. To find out more about having all added value services deactivated except for eCall, search Ask Ford on the local Ford website or contact the Ford Customer Relationship Center by e-mail through the FordPass app or by using the e-mail address on the local Ford website.

## END USER LICENSE AGREEMENT

### VEHICLE SOFTWARE END USER LICENSE AGREEMENT (EULA)

- You ("You" or "Your" as applicable) have acquired a vehicle having several devices, including SYNC ® and various control modules, ("DEVICES") that include software licensed or owned by Ford Motor Company and its affiliates ("FORD MOTOR COMPANY"). Those software products of FORD MOTOR COMPANY origin, as well as associated media, printed materials, and "online" or electronic documentation ("SOFTWARE") are protected by international intellectual property laws and treaties. The SOFTWARE is licensed, not sold. All rights reserved.
- The SOFTWARE may interface with and/or communicate with, or may be later upgraded to interface with and/or communicate with additional software and/or systems provided by FORD MOTOR COMPANY.

**IF YOU DO NOT AGREE TO THIS END USER LICENSE AGREEMENT ("EULA") DO NOT USE THE DEVICES OR COPY THE SOFTWARE. ANY USE OF THE SOFTWARE, INCLUDING BUT NOT LIMITED TO USE ON THE DEVICES, WILL CONSTITUTE YOUR AGREEMENT TO THIS EULA (OR RATIFICATION OF ANY PREVIOUS CONSENT).**

**GRANT OF SOFTWARE LICENSE:** This EULA grants you the following license:

- You may use the SOFTWARE as installed on the DEVICES and as otherwise interfacing with systems and/or services provide by or through FORD MOTOR COMPANY or its third party software and service providers.

### Description of Other Rights and Limitations

- **Speech Recognition:** If the SOFTWARE includes speech recognition component(s), you should understand that speech recognition is an inherently statistical process and that recognition errors are inherent in the process. Neither FORD MOTOR



# Appendices

---

COMPANY nor its suppliers shall be liable for any damages arising out of errors in the speech recognition process. It is your responsibility to monitor any speech recognition functions included in the system.

- **Limitations on Reverse Engineering, Decompilation and Disassembly:**

You may not reverse engineer, decompile, translate, disassemble or attempt to discover any source code or underlying ideas or algorithms of the SOFTWARE nor permit others to reverse engineer, decompile or disassemble the SOFTWARE, except and only to the extent that such activity is expressly permitted by applicable law notwithstanding this limitation or to the extent as may be permitted by the licensing terms governing use of any open source components included with the SOFTWARE.

- **Limitations on Distributing, Copying, Modifying and Creating Derivative Works:**

You may not distribute, copy, make modifications to or create derivative works based on the SOFTWARE, except and only to the extent that such activity is expressly permitted by applicable law notwithstanding this limitation or to the extent as may be permitted by the licensing terms governing use of any open source components included with the SOFTWARE.

- **Single EULA:** The end user documentation for the DEVICES and related systems and services may contain multiple EULAs, such as multiple translations and/or multiple media versions (e.g., in the user documentation and in the software). Even if you receive multiple EULAs, you are licensed to use only one (1) copy of the SOFTWARE.

- **SOFTWARE Transfer:** You may permanently transfer your rights under this EULA only as part of a sale or transfer of the DEVICES, provided you retain no copies, you transfer all of the SOFTWARE (including all component parts, the media and printed materials, any upgrades, and, if applicable, the Certificate(s) of Authenticity), and the recipient agrees to the terms of this EULA. If the SOFTWARE is an upgrade, any transfer must include all prior versions of the SOFTWARE.

- **Termination:** Without prejudice to any other rights, FORD MOTOR COMPANY may terminate this EULA if you fail to comply with the terms and conditions of this EULA.

- **Internet-Based Services**

**Components:** The SOFTWARE may contain components that enable and facilitate the use of certain Internet-based services. You acknowledge and agree that FORD MOTOR COMPANY, third party software and service suppliers, its affiliates and/or its designated agent may automatically check the version of the SOFTWARE and/or its components that you are utilizing and may provide upgrades or supplements to the SOFTWARE that may be automatically downloaded to your DEVICES.

- **Additional Software/Services:** The SOFTWARE may permit FORD MOTOR COMPANY, third party software and service suppliers, its affiliates and/or its designated agent to provide or make available to you SOFTWARE updates, supplements, add-on components, or Internet-based services components of the SOFTWARE after the date you obtain your initial copy of the SOFTWARE ("Supplemental Components".) SOFTWARE updates may cause you to incur additional

# Appendices

---

charges from your wireless service provider. If FORD MOTOR COMPANY or third party software and services suppliers provide or make available to you Supplemental Components and no other EULA terms are provided along with the Supplemental Components, then the terms of this EULA shall apply. FORD MOTOR COMPANY, its affiliates and/or its designated agent reserve the right to discontinue without liability any Internet-based services provided to you or made available to you through the use of the SOFTWARE.

- **Links to Third Party Sites:** The SOFTWARE may provide you with the ability to link to third party sites. The third party sites are not under the control of FORD MOTOR COMPANY, its affiliates and/or its designated agent. Neither FORD MOTOR COMPANY nor its affiliates nor its designated agent are responsible for (i) the contents of any third party sites, any links contained in third party sites, or any changes or updates to third party sites, or (ii) webcasting or any other form of transmission received from any third party sites. If the SOFTWARE provides links to third party sites, those links are provided to you only as a convenience, and the inclusion of any link does not imply an endorsement of the third party site by FORD MOTOR COMPANY, its affiliates and/or its designated agent.

- **Obligation to Drive Responsibly:** You recognize your obligation to drive responsibly and keep attention on the road. You will read and abide with the DEVICES operating instructions particularly as they pertain to safety and you agree to assume any risk associated with the use of the DEVICES.

## **UPGRADES AND RECOVERY MEDIA:**

If the SOFTWARE is provided by FORD MOTOR COMPANY separate from the DEVICES on media such as a ROM chip, CD ROM disk(s) or via web download or other means, and is labeled "For Upgrade Purposes Only" or "For Recovery Purposes Only" you may install one (1) copy of such SOFTWARE onto the DEVICES as a replacement copy for the existing SOFTWARE, and use it in accordance with this EULA, including any additional EULA terms accompanying the upgrade SOFTWARE.

## **INTELLECTUAL PROPERTY RIGHTS:**

All title and intellectual property rights in and to the SOFTWARE (including but not limited to any images, photographs, animations, video, audio, music, text and "applets" incorporated into the SOFTWARE), the accompanying printed materials, and any copies of the SOFTWARE, are owned by FORD MOTOR COMPANY, or its affiliates or suppliers. The SOFTWARE is licensed, not sold. You may not copy the printed materials accompanying the SOFTWARE. All title and intellectual property rights in and to the content which may be accessed through use of the SOFTWARE is the property of the respective content owner and may be protected by applicable copyright or other intellectual property laws and treaties. This EULA grants you no rights to use such content outside its intended use. All rights not specifically granted under this EULA are reserved by FORD MOTOR COMPANY, its affiliates, and third party software and service providers and suppliers. Use of any on-line services which may be accessed through the SOFTWARE may be governed by the respective terms of use relating to such services. If this SOFTWARE contains documentation that is provided only in electronic form, you may print one copy of such electronic documentation.

# Appendices

---

**EXPORT RESTRICTIONS:** You acknowledge that the SOFTWARE is subject to U.S. and European Union export jurisdiction. You agree to comply with all applicable international and national laws that apply to the SOFTWARE, including the U.S. Export Administration Regulations, as well as end-user, end-use and destination restrictions issued by U.S. and other governments.

**TRADEMARKS:** This EULA does not grant you any rights in connection with any trademarks or service marks of FORD MOTOR COMPANY, its affiliates, and third party software and service providers.

The **Bluetooth®** word mark and logos are registered trademarks owned by **Bluetooth SIG, Inc.** and any use of such marks by Ford Motor Company is under license. Other trademarks and trade names are those of their respective owners.

**PRODUCT SUPPORT:** Please refer to FORD MOTOR COMPANY instructions provided in the documentation for the DEVICES product support, such as the vehicle owner guide.

Should you have any questions concerning this EULA, or if you desire to contact FORD MOTOR COMPANY for any other reason, please refer to the address provided in the documentation for the DEVICES.

**No Liability for Certain Damages:** EXCEPT AS PROHIBITED BY LAW, FORD MOTOR COMPANY, ANY THIRD PARTY SOFTWARE OR SERVICES SUPPLIERS, AND THEIR AFFILIATES SHALL HAVE NO LIABILITY FOR ANY INDIRECT, SPECIAL, CONSEQUENTIAL OR INCIDENTAL DAMAGES ARISING FROM OR IN CONNECTION WITH THE USE OR PERFORMANCE OF THE SOFTWARE. THIS

LIMITATION SHALL APPLY EVEN IF ANY REMEDY FAILS OF ITS ESSENTIAL PURPOSE. THERE ARE NO WARRANTIES OTHER THAN THOSE THAT MAY BE EXPRESSLY PROVIDED FOR YOUR NEW VEHICLE.

## **SYNC® Automotive Important Safety Information Read and follow instructions:**

- Before using your SYNC® system, read and follow all instructions and safety information provided in this end user manual ("Owner Guide".) Not following precautions found in the Owner Guide can lead to an accident or other serious injuries.

### General Operation

- **Voice Command Control:** Certain functions within the SYNC® system may be accomplished using voice commands. Using voice commands while driving helps you to operate the system without removing your hands from the wheel or eyes from the road.
- **Prolonged Views of Screen:** Do not access any function requiring a prolonged view of the screen while you are driving. Pull over in a safe and legal manner before attempting to access a function of the system requiring prolonged attention.
- **Volume Setting:** Do not raise the volume excessively. Keep the volume at a level where you can still hear outside traffic and emergency signals while driving. Driving while unable to hear these sounds could cause an accident.

# Appendices

---

- **Navigation Features:** Any navigation features included in the system are intended to provide turn by turn instructions to get you to a desired destination. Please make certain all persons using this system carefully read and follow instructions and safety information fully.
- **Distraction Hazard:** Any navigation features may require manual (non-verbal) setup. Attempting to perform such set-up or insert data while driving can distract your attention and could cause an accident or other serious injury. Stop the vehicle in a safe and legal manner before attempting these operations.
- **Let Your Judgment Prevail:** Any navigation features are provided only as an aid. Make your driving decisions based on your observations of local conditions and existing traffic regulations. Any such feature is not a substitute for your personal judgment. Any route suggestions made by this system should never replace any local traffic regulations or your personal judgment or knowledge of safe driving practices.
- **Route Safety:** Do not follow the route suggestions if doing so would result in an unsafe or illegal maneuver, if you would be placed in an unsafe situation, or if you would be directed into an area that you consider unsafe. The driver is ultimately responsible for the safe operation of the vehicle and therefore, must evaluate whether it is safe to follow the suggested directions.
- **Potential Map Inaccuracy:** Maps used by this system may be inaccurate because of changes in roads, traffic controls or driving conditions. Always use good judgment and common sense when following the suggested routes.
- **Emergency Services:** Do not rely on any navigation features included in the system to route you to emergency services. Ask local authorities or an emergency services operator for these locations. Not all emergency services such as police, fire stations, hospitals and clinics are likely to be contained in the map database for such navigation features.

# Appendices

---

## Your Responsibilities and Assumptions of Risk

- You agree to each of the following: (a) Any use of the SOFTWARE while driving an automobile or other vehicle in violation of applicable law or otherwise driving in an unsafe manner presents a significant risk of distracted driving and should not be attempted under any circumstances; (b) Use of the SOFTWARE at excessive volume poses a significant risk of hearing damage and should not be attempted under any circumstances; (c) The SOFTWARE may not be compatible with new or different versions of an operating system, third party software, or third party services, and the SOFTWARE may potentially cause a critical failure of an operating system, third party software, or third party service. (d) Any third party service accessed by or third party software used with the SOFTWARE (i) may charge an additional fee for access, (ii) may not work correctly, on an uninterrupted basis, or error free, (iii) may change streaming formats or discontinue operation, (iv) may contain adult, profane or offensive content; and (v) may contain inaccurate, false or misleading traffic, weather, financial or safety information or other content; and (e) Use of the SOFTWARE may cause you to incur additional charges from your wireless service provider (WSP) and any data or minute calculators that may be included in the software program are for reference only, are not warranted in any way and should not be relied upon in anyway.
- When using the SOFTWARE, you agree to be responsible for and assume the entire risk to the items set forth in Section (a) – (e) above.

## Disclaimer of Warranty

YOU EXPRESSLY ACKNOWLEDGE AND AGREE THAT USE OF THE DEVICES AND SOFTWARE IS AT YOUR SOLE RISK AND THAT THE ENTIRE RISK AS TO SATISFACTORY QUALITY, PERFORMANCE, COMPATIBILITY, ACCURACY AND EFFORT IS WITH YOU. TO THE MAXIMUM EXTENT PERMITTED BY APPLICABLE LAW, THE SOFTWARE AND ANY THIRD PARTY SOFTWARE OR THIRD-PARTY SERVICES ARE PROVIDED "AS IS" AND "AS AVAILABLE", WITH ALL FAULTS AND WITHOUT WARRANTY OF ANY KIND, AND FORD MOTOR COMPANY HEREBY DISCLAIMS ALL WARRANTIES AND CONDITIONS WITH RESPECT TO THE SOFTWARE, THIRD PARTY SOFTWARE, AND THIRD-PARTY SERVICES, EITHER EXPRESS, IMPLIED OR STATUTORY, INCLUDING, BUT NOT LIMITED TO, THE IMPLIED WARRANTIES AND/OR CONDITIONS OF MERCHANTABILITY, OF SATISFACTORY QUALITY, OF FITNESS FOR AN PARTICULAR PURPOSE, OF ACCURACY, OF QUIET ENJOYMENT, AND NON-INFRINGEMENT OF THIRD-PARTY RIGHTS. FORD MOTOR COMPANY DOES NOT WARRANT (a) AGAINST INTERFERENCE WITH YOUR ENJOYMENT OF THE SOFTWARE, THIRD PARTY SOFTWARE, OR THIRD-PARTY SERVICES, (b) THAT THE SOFTWARE, THIRD PARTY SOFTWARE, OR THIRD-PARTY SERVICES WILL MEET YOUR REQUIREMENTS, (c) THAT THE OPERATION OF THE SOFTWARE, THIRD PARTY SOFTWARE, OR THIRD-PARTY SERVICES WILL BE UNINTERRUPTED OR ERROR-FREE, (d) OR THAT DEFECTS IN THE SOFTWARE, THIRD PARTY SOFTWARE, OR THIRD-PARTY SERVICES WILL BE CORRECTED. NO ORAL OR WRITTEN INFORMATION OR ADVICE GIVEN BY FORD MOTOR COMPANY OR ITS AUTHORIZED REPRESENTATIVE SHALL

# Appendices

---

CREATE A WARRANTY. SHOULD THE SOFTWARE, THIRD PARTY SOFTWARE, OR THIRD-PARTY SERVICES PROVE DEFECTIVE, YOU ASSUME THE ENTIRE COST OF ALL NECESSARY SERVICING, REPAIR OR CORRECTION. SOME JURISDICTIONS DO NOT ALLOW THE DISCLAIMER OF IMPLIED WARRANTIES OR LIMITATIONS ON APPLICABLE STATUTORY RIGHTS OF A CONSUMER, SO THE ABOVE DISCLAIMER MAY NOT FULLY APPLY TO YOU. THE SOLE WARRANTY PROVIDED BY FORD MOTOR COMPANY SHALL BE FOUND IN THE WARRANTY INFORMATION INCLUDING WITH YOUR OWNER GUIDE. TO THE EXTENT THAT THERE IS ANY CONFLICT BETWEEN THE TERMS OF THIS SECTION AND THE WARRANTY BOOKLET, THE WARRANTY BOOKLET SHALL CONTROL.

## Applicable Law, Venue, Jurisdiction

- The laws of the State of Michigan govern this EULA and Your use of the SOFTWARE. Your use of the SOFTWARE may also be subject to other local, state, national, or international laws. Any litigation arising out of or related to this EULA shall be brought and maintained exclusively in a court of the State of Michigan located in Wayne County or in the United States District Court for the Eastern District of Michigan. You hereby consent to submit to the personal jurisdiction of a court in the State of Michigan located in Wayne County and the United States District Court for the Eastern District of Michigan for any dispute arising out of or relating to this EULA.

## Binding Arbitration and Class Action Waiver

**(a) Application.** This Section applies to any dispute EXCEPT IT DOES NOT INCLUDE A DISPUTE RELATING TO COPYRIGHT INFRINGEMENT, OR TO THE ENFORCEMENT OR VALIDITY OF YOUR, FORD MOTOR COMPANY, OR ANY OF FORD MOTOR COMPANY'S LICENSORS' INTELLECTUAL PROPERTY RIGHTS.

Dispute means any dispute, action, or other controversy between You and FORD MOTOR COMPANY, other than the exceptions listed above, concerning the SOFTWARE (including its price) or this EULA, whether in contract, warranty, tort, statute, regulation, ordinance, or any other legal or equitable basis.

**(b) Notice of Dispute.** In the event of a Dispute, You or FORD MOTOR COMPANY must give the other a "Notice of Dispute", which is a written statement of the name, address, and contact information of the party giving it, the facts giving rise to the dispute, and the relief requested. You and FORD MOTOR COMPANY will attempt to resolve any dispute through informal negotiation within 60 days from the date the Notice of Dispute is sent. After 60 days, You or FORD MOTOR COMPANY may commence arbitration.

**(c) Small claims court.** You may also litigate any dispute in small claims court in your county of residence or FORD MOTOR COMPANY'S principal place of business, if the dispute meets all requirements to be heard in the small claims court. You may litigate in small claims court whether or not You negotiated informally first.

**(d) Binding arbitration.** If You and FORD MOTOR COMPANY, do not resolve any dispute by informal negotiation or in small claims court, any other effort to resolve the dispute will be conducted exclusively by binding arbitration. You are giving up

# Appendices

the right to litigate (or participate in as a party or class member) all disputes in court before a judge or jury. Instead, all disputes will be resolved before a neutral arbitrator, whose decision will be final except for a limited right of appeal under the Federal Arbitration Act. Any court with jurisdiction over the parties may enforce the arbitrator's award.

**(e) Class action waiver.** Any proceedings to resolve or litigate any dispute in any forum will be conducted solely on an individual basis. Neither you nor FORD MOTOR COMPANY, will seek to have any dispute heard as a class action, as a private attorney general action, or in any other proceeding in which any party acts or proposes to act in a representative capacity. No arbitration or proceeding will be combined with another without the prior written consent of all parties to all affected arbitrations or proceedings.

**(f) Arbitration procedure.** Any arbitration will be conducted by the American Arbitration Association (the "AAA"), under its Commercial Arbitration Rules. If You are an individual and use the SOFTWARE for personal or vehicle use, or if the value of the dispute is \$75,000 or less whether or not You are an individual or how You use the SOFTWARE, the AAA Supplementary Procedures for Consumer-Related Disputes will also apply. To commence arbitration, submit a Commercial Arbitration Rules Demand for Arbitration form to the AAA. You may request a telephonic or in-person hearing by following the AAA rules. In a dispute involving \$10,000 or less, any hearing will be telephonic unless the arbitrator finds good cause to hold an in-person hearing instead. For more information, see [adr.org](http://adr.org) or call 1-800-778-7879. You agree to commence arbitration only in your county of residence or FORD MOTOR COMPANY'S principal place of business. The arbitrator

may award the same damages to You individually as a court could. The arbitrator may award declaratory or injunctive relief only to You individually, and only to the extent required to satisfy Your individual claim.

## **(g) Arbitration fees and incentives.**

- I. Disputes involving \$75,000 or less. FORD MOTOR COMPANY will promptly reimburse your filing fees and pay the AAA's and arbitrator's fees and expenses. If you reject FORD MOTOR COMPANY'S last written settlement offer made before the arbitrator was appointed ("last written offer"), your dispute goes all the way to an arbitrator's decision (called an "award"), and the arbitrator awards you more than the last written offer, FORD MOTOR COMPANY will give you three incentives: (1) pay the greater of the award or \$1,000; (2) pay twice your reasonable attorney's fees, if any; and (3) reimburse any expenses (including expert witness fees and costs) that your attorney reasonably accrues for investigating, preparing, and pursuing your claim in arbitration. The arbitrator will determine the amounts.
- ii. Disputes involving more than \$75,000. The AAA rules will govern payment of filing fees and the AAA's and arbitrator's fees and expenses.
- iii. Disputes involving any amount. In any arbitration you commence, FORD MOTOR COMPANY will seek its AAA or arbitrator's fees and expenses, or Your filing fees it reimbursed, only if the arbitrator finds the arbitration frivolous or brought for an improper purpose. In any arbitration FORD MOTOR COMPANY commences, it will pay all

# Appendices

---

filing, AAA, and arbitrator's fees and expenses. It will not seek its attorney's fees or expenses from you in any arbitration. Fees and expenses are not counted in determining how much a dispute involves.

**(h) Claims or disputes must be filed within one year.** To the extent permitted by law, any claim or dispute under this EULA to which this Section applies must be filed within one year in small claims court (Section c) or in arbitration (Section d). The one-year period begins when the claim or dispute first could be filed. If such a claim or dispute is not filed within one year, it is permanently barred.

**(I) Severability.** If the class action waiver (Section e) is found to be illegal or unenforceable as to all or some parts of a dispute, then that portion of Section e will not apply to those parts. Instead, those parts will be severed and proceed in a court of law, with the remaining parts proceeding in arbitration. If any other provision of that portion Section e is found to be illegal or unenforceable, that provision will be severed with the remainder of Section e remaining in full force and effect.

## **Telenav Software End User License Agreement**

Please read these terms and conditions carefully before you use the TeleNav Software. Your use of the TeleNav Software indicates that you accept these terms and conditions. If you do not accept these terms and conditions, do not break the seal of the package, launch, or otherwise use the TeleNav Software. TeleNav may revise this Agreement and the privacy policy at any time, with or without notice to you. You agree to visit <http://www.telenav.com> from time to time to review the then current version of this Agreement and of the privacy policy.

## **1. Safe and Lawful Use**

You acknowledge that devoting attention to the TeleNav Software may pose a risk of injury or death to you and others in situations that otherwise require your undivided attention, and you therefore agree to comply with the following when using the TeleNav Software:

- (a) observe all traffic laws and otherwise drive safely;
- (b) use your own personal judgment while driving. If you feel that a route suggested by the TeleNav Software instructs you to perform an unsafe or illegal maneuver, places you in an unsafe situation, or directs you into an area that you consider to be unsafe, do not follow such instructions;
- (c) do not input destinations, or otherwise manipulate the TeleNav Software, unless your vehicle is stationary and parked;
- (d) do not use the TeleNav Software for any illegal, unauthorized, unintended, unsafe, hazardous, or unlawful purposes, or in any manner inconsistent with this Agreement;
- (e) arrange all GPS and wireless devices and cables necessary for use of the TeleNav Software in a secure manner in your vehicle so that they will not interfere with your driving and will not prevent the operation of any safety device (such as an airbag).

You agree to indemnify and hold TeleNav harmless against all claims resulting from any dangerous or otherwise inappropriate use of the TeleNav Software in any moving vehicle, including as a result of your failure to comply with the directions above.



# Appendices

## 2. Account Information

You agree: (a) when registering the TeleNav Software, to provide TeleNav with true, accurate, current, and complete information about yourself, and (b) to inform TeleNav promptly of any changes to such information, and to keep it true, accurate, current and complete.

## 3. Software License

- Subject to your compliance with the terms of this Agreement, TeleNav hereby grants to you a personal, non-exclusive, non-transferable license (except as expressly permitted below in connection with your permanent transfer of the TeleNav Software license), without the right to sublicense, to use the TeleNav Software (in object code form only) in order to access and use the TeleNav Software. This license shall terminate upon any termination or expiration of this Agreement. You agree that you will use the TeleNav Software only for your personal business or leisure purposes, and not to provide commercial navigation services to other parties.

### 3.1 License Limitations

- **(a)** reverse engineer, decompile, disassemble, translate, modify, alter or otherwise change the TeleNav Software or any part thereof; **(b)** attempt to derive the source code, audio library or structure of the TeleNav Software without the prior express written consent of TeleNav; **(c)** remove from the TeleNav Software, or alter, any of TeleNav's or its suppliers' trademarks, trade names, logos, patent or copyright notices, or other notices or markings; **(d)**

distribute, sublicense or otherwise transfer the TeleNav Software to others, except as part of your permanent transfer of the TeleNav Software; or **(e)** use the TeleNav Software in any manner that

- i. infringes the intellectual property or proprietary rights, rights of publicity or privacy or other rights of any party,
- ii. violates any law, statute, ordinance or regulation, including but not limited to laws and regulations related to spamming, privacy, consumer and child protection, obscenity or defamation, or
- iii. is harmful, threatening, abusive, harassing, tortuous, defamatory, vulgar, obscene, libelous, or otherwise objectionable; and (f) lease, rent out, or otherwise permit unauthorized access by third parties to the TeleNav Software without advanced written permission of TeleNav.

## 4. Disclaimers

- To the fullest extent permissible pursuant to applicable law, in no event will TeleNav, its licensors and suppliers, or agents or employees of any of the foregoing, be liable for any decision made or action taken by you or anyone else in reliance on the information provided by the TeleNav Software. TeleNav also does not warrant the accuracy of the map or other data used for the TeleNav Software. Such data may not always reflect reality due to, among other things, road closures, construction, weather, new roads and other changing conditions. You are responsible for the entire risk arising out of your use of the TeleNav Software. For example but without limitation, you agree not to rely on the TeleNav Software for critical navigation in areas where the well-being or survival of you or others

# Appendices

---

is dependent on the accuracy of navigation, as the maps or functionality of the TeleNav Software are not intended to support such high risk applications, especially in more remote geographical areas.

- TELENV EXPRESSLY DISCLAIMS AND EXCLUDES ALL WARRANTIES IN CONNECTION WITH THE TELENV SOFTWARE, WHETHER STATUTORY, EXPRESS OR IMPLIED, INCLUDING ALL WARRANTIES WHICH MAY ARISE FROM COURSE OF DEALING, CUSTOM OR TRADE AND INCLUDING, BUT NOT LIMITED TO, THE IMPLIED WARRANTIES OF MERCHANTABILITY, FITNESS FOR A PARTICULAR PURPOSE AND NON-INFRINGEMENT OF THIRD PARTY RIGHTS WITH RESPECT TO THE TELENV SOFTWARE.
- Certain jurisdictions do not permit the disclaimer of certain warranties, so this limitation may not apply to you.

## **5. Limitation of Liability**

- TO THE EXTENT PERMITTED UNDER APPLICABLE LAW, UNDER NO CIRCUMSTANCES SHALL TELENV OR ITS LICENSORS AND SUPPLIERS BE LIABLE TO YOU OR TO ANY THIRD PARTY FOR ANY INDIRECT, INCIDENTAL, CONSEQUENTIAL, SPECIAL OR EXEMPLARY DAMAGES (INCLUDING IN EACH CASE, BUT NOT LIMITED TO, DAMAGES FOR THE INABILITY TO USE THE EQUIPMENT OR ACCESS DATA, LOSS OF DATA, LOSS OF BUSINESS, LOSS OF PROFITS, BUSINESS INTERRUPTION OR THE LIKE) ARISING OUT OF THE USE OF OR INABILITY TO USE THE TELENV SOFTWARE, EVEN IF TELENV HAS BEEN ADVISED OF THE POSSIBILITY OF SUCH DAMAGES. NOTWITHSTANDING ANY DAMAGES THAT YOU MIGHT INCUR FOR ANY

REASON WHATSOEVER (INCLUDING, WITHOUT LIMITATION, ALL DAMAGES REFERENCED HEREIN AND ALL DIRECT OR GENERAL DAMAGES IN CONTRACT, TORT (INCLUDING NEGLIGENCE) OR OTHERWISE), THE ENTIRE LIABILITY OF TELENV AND OF ALL OF TELENV'S SUPPLIERS SHALL BE LIMITED TO THE AMOUNT ACTUALLY PAID BY YOU FOR THE TELENV SOFTWARE. SOME STATES AND/OR JURISDICTIONS DO NOT ALLOW THE EXCLUSION OR LIMITATION OF INCIDENTAL OR CONSEQUENTIAL DAMAGES, SO THE ABOVE LIMITATIONS OR EXCLUSIONS MAY NOT APPLY TO YOU.

## **6. Arbitration and Governing Law**

- You agree that any dispute, claim or controversy arising out of or relating to this Agreement or the TeleNav Software shall be settled by independent arbitration involving a neutral arbitrator and administered by the American Arbitration Association in the County of Santa Clara, California. The arbitrator shall apply the Commercial Arbitration Rules of the American Arbitration Association, and the judgment upon the award rendered by the arbitrator may be entered by any court having jurisdiction. Note that there is no judge or jury in an arbitration proceeding and the decision of the arbitrator shall be binding upon both parties. You expressly agree to waive your right to a jury trial. This Agreement and performance hereunder will be governed by and construed in accordance with the laws of the State of California, without giving effect to its conflict of law provisions. To the extent judicial action is necessary in connection with the binding arbitration, both TeleNav and you agree to submit

# Appendices

---

to the exclusive jurisdiction of the courts of the County of Santa Clara, California. The United Nations Convention on Contracts for the International Sale of Goods shall not apply.

## **7. Assignment**

- You may not resell, assign, or transfer this Agreement or any of your rights or obligations, except in totality, in connection with your permanent transfer of the TeleNav Software, and expressly conditioned upon the new user of the TeleNav Software agreeing to be bound by the terms and conditions of this Agreement. Any such sale, assignment or transfer that is not expressly permitted under this paragraph will result in immediate termination of this Agreement, without liability to TeleNav, in which case you and all other parties shall immediately cease all use of the TeleNav Software. Notwithstanding the foregoing, TeleNav may assign this Agreement to any other party at any time without notice, provided the assignee remains bound by this Agreement.

## **8. Miscellaneous**

### **8.1**

This Agreement constitutes the entire agreement between TeleNav and you with respect to the subject matter hereof.

### **8.2**

Except for the limited licenses expressly granted in this Agreement, TeleNav retains all right, title and interest in and to the TeleNav Software, including without limitation all related intellectual property rights. No licenses or other rights which are not expressly granted in this Agreement are intended to, or shall be, granted or

conferred by implication, statute, inducement, estoppel or otherwise, and TeleNav and its suppliers and licensors hereby reserve all of their respective rights other than the licenses explicitly granted in this Agreement.

### **8.3**

By using the TeleNav Software, you consent to receive from TeleNav all communications, including notices, agreements, legally required disclosures or other information in connection with the TeleNav Software (collectively, "Notices") electronically. TeleNav may provide such Notices by posting them on TeleNav's Website or by downloading such Notices to your wireless device. If you desire to withdraw your consent to receive Notices electronically, you must discontinue your use of the TeleNav Software.

### **8.4**

TeleNav's or your failure to require performance of any provision shall not affect that party's right to require performance at any time thereafter, nor shall a waiver of any breach or default of this Agreement constitute a waiver of any subsequent breach or default or a waiver of the provision itself.

### **8.5**

If any provision herein is held unenforceable, then such provision will be modified to reflect the intention of the parties, and the remaining provisions of this Agreement will remain in full force and effect.

# Appendices

## 8.6

The headings in this Agreement are for convenience of reference only, will not be deemed to be a part of this Agreement, and will not be referred to in connection with the construction or interpretation of this Agreement. As used in this Agreement, the words "include" and "including" and variations thereof, will not be deemed to be terms of limitation, but rather will be deemed to be followed by the words "without limitation".

## 9. Other Vendors Terms and Conditions

- The Telenav Software utilizes map and other data licensed to Telenav by third party vendors for the benefit of you and other end users. This Agreement includes end-user terms applicable to these companies (included at the end of this Agreement), and thus your use of the Telenav Software is also subject to such terms. You agree to comply with the following additional terms and conditions, which are applicable to Telenav's third party vendor licensors::

### 9.1 End User Terms Required by HERE North America, LLC

The data ("Data") is provided for your personal, internal use only and not for resale. It is protected by copyright, and is subject to the following terms and conditions which are agreed to by you, on the one hand, and Telenav ("Telenav") and its licensors (including their licensors and suppliers) on the other hand.

© 2013 HERE. All rights reserved.

The Data for areas of Canada includes information taken with permission from Canadian authorities, including: © Her Majesty the Queen in Right of Canada, © Queen's Printer for Ontario, © Canada Post Corporation, GeoBase®, © Department of Natural Resources Canada.

HERE holds a non-exclusive license from the United States Postal Service® to publish and sell ZIP+4® information.

©United States Postal Service® 2014. Prices are not established, controlled or approved by the United States Postal Service®. The following trademarks and registrations are owned by the USPS: United States Postal Service, USPS, and ZIP+4

The Data for Mexico includes certain data from Instituto Nacional de Estadística y Geografía.

### 9.2 End User Terms Required by NAV2 (Shanghai) Co., Ltd

The data ("Data") is provided for your personal, internal use only and not for resale. It is protected by copyright, and is subject to the following terms and conditions which are agreed to by you, on the one hand, and NAV2 (Shanghai) Co., Ltd ("NAV2") and its licensors (including their licensors and suppliers) on the other hand. 20xx. All rights reserved

### Terms and Conditions

**Permitted Use.** You agree to use this Data together with the Telenav Software solely for the internal business and personal purposes for which you were licensed, and not for service bureau, time-sharing or other similar purposes. Accordingly, but subject to the restrictions set forth in the following paragraphs, you agree not to otherwise reproduce, copy, modify, decompile, disassemble, create any derivative works of, or reverse engineer any portion of this Data, and may not transfer or distribute it in any form, for any purpose, except to the extent permitted by mandatory laws.

# Appendices

---

**Restrictions.** Except where you have been specifically licensed to do so by Telenav, and without limiting the preceding paragraph, you may not use this Data (a) with any products, systems, or applications installed or otherwise connected to or in communication with vehicles, capable of vehicle navigation, positioning, dispatch, real time route guidance, fleet management or similar applications; or (b) with or in communication with any positioning devices or any mobile or wireless-connected electronic or computer devices, including without limitation cellular phones, palmtop and handheld computers, pagers, and personal digital assistants or PDAs.

**Warning.** The Data may contain inaccurate or incomplete information due to the passage of time, changing circumstances, sources used and the nature of collecting comprehensive geographic data, any of which may lead to incorrect results.

**No Warranty.** This Data is provided to you “as is,” and you agree to use it at your own risk. Telenav and its licensors (and their licensors and suppliers) make no guarantees, representations or warranties of any kind, express or implied, arising by law or otherwise, including but not limited to, content, quality, accuracy, completeness, effectiveness, reliability, fitness for a particular purpose, usefulness, use or results to be obtained from this Data, or that the Data or server will be uninterrupted or error-free.

**Disclaimer of Warranty:** TELENAV AND ITS LICENSORS (INCLUDING THEIR LICENSORS AND SUPPLIERS) DISCLAIM ANY WARRANTIES, EXPRESS OR IMPLIED, OF QUALITY, PERFORMANCE, MERCHANTABILITY, FITNESS FOR A

PARTICULAR PURPOSE OR NON-INFRINGEMENT. Some States, Territories and Countries do not allow certain warranty exclusions, so to that extent the above exclusion may not apply to you.

**Disclaimer of Liability:** TELENAV AND ITS LICENSORS (INCLUDING THEIR LICENSORS AND SUPPLIERS) SHALL NOT BE LIABLE TO YOU: IN RESPECT OF ANY CLAIM, DEMAND OR ACTION, IRRESPECTIVE OF THE NATURE OF THE CAUSE OF THE CLAIM, DEMAND OR ACTION ALLEGING ANY LOSS, INJURY OR DAMAGES, DIRECT OR INDIRECT, WHICH MAY RESULT FROM THE USE OR POSSESSION OF THE INFORMATION; OR FOR ANY LOSS OF PROFIT, REVENUE, CONTRACTS OR SAVINGS, OR ANY OTHER DIRECT, INDIRECT, INCIDENTAL, SPECIAL OR CONSEQUENTIAL DAMAGES ARISING OUT OF YOUR USE OF OR INABILITY TO USE THIS INFORMATION, ANY DEFECT IN THE INFORMATION, OR THE BREACH OF THESE TERMS OR CONDITIONS, WHETHER IN AN ACTION IN CONTRACT OR TORT OR BASED ON A WARRANTY, EVEN IF TELENAV OR ITS LICENSORS HAVE BEEN ADVISED OF THE POSSIBILITY OF SUCH DAMAGES. Some States, Territories and Countries do not allow certain liability exclusions or damages limitations, so to that extent the above may not apply to you.

**Export Control.** You shall not export from anywhere any part of the Data or any direct product thereof except in compliance with, and with all licenses and approvals required under, applicable export laws, rules and regulations, including but not limited to the laws, rules and regulations administered by the Office of Foreign Assets Control of the U.S. Department of Commerce and the Bureau of Industry and Security of the U.S. Department of Commerce. To the extent that any such

# Appendices

export laws, rules or regulations prohibit HERE from complying with any of its obligations hereunder to deliver or distribute Data, such failure shall be excused and shall not constitute a breach of this Agreement.

**Entire Agreement.** These terms and conditions constitute the entire agreement between Telenav (and its licensors, including their licensors and suppliers) and you pertaining to the subject matter hereof, and supersedes in their entirety any and all written or oral agreements previously existing between us with respect to such subject matter.

**Governing Law.** The above terms and conditions shall be governed by the laws of the State of Illinois [insert "Netherlands" where European HERE Data is used], without giving effect to (i) its conflict of laws provisions, or (ii) the United Nations Convention for Contracts for the International Sale of Goods, which is explicitly excluded. You agree to submit to the jurisdiction of the State of Illinois [insert "The Netherlands" where European HERE Data is used] for any and all disputes, claims and actions arising from or in connection with the Data provided to you hereunder.

**Government End Users.** If the Data is being acquired by or on behalf of the United States government or any other entity seeking or applying rights similar to those customarily claimed by the United States government, this Data is a "commercial item" as that term is defined at 48 C.F.R. ("FAR") 2.101, is licensed in accordance with these End-User Terms, and each copy of Data delivered or otherwise furnished shall be marked and embedded as appropriate with the following "Notice of Use," and shall be treated in accordance with such Notice:

NOTICE OF USE
CONTRACTOR (MANUFACTURER/SUPPLIER) NAME: HERE
CONTRACTOR (MANUFACTURER/SUPPLIER) ADDRESS: c/o Nokia, 425 West Randolph Street, Chicago, Illinois 60606
This Data is a commercial item as defined in FAR 2.101 and is subject to these End-User Terms under which this Data was provided.
© 1987 – 2014 HERE – All rights reserved.

If the Contracting Officer, federal government agency, or any federal official refuses to use the legend provided herein, the Contracting Officer, federal government agency, or any federal official must notify HERE prior to seeking additional or alternative rights in the Data.

## I. US/Canada Territory

A. United States Data. The End-User Terms for any Application containing Data for the United States shall contain the following notices:

"HERE holds a non-exclusive license from the United States Postal Service® to publish and sell ZIP+4® information."

"©United States Postal Service® 20XX. Prices are not established, controlled or approved by the United States Postal Service®. The following trademarks and registrations are owned by the USPS: United States Postal Service, USPS, and ZIP+4."

# Appendices

---

B. Canada Data. The following provisions apply to the Data for Canada, which may include or reflect data from third party licensors (“Third Party Data”), including Her Majesty the Queen in Right of Canada (“Her Majesty”), Canada Post Corporation (“Canada Post”) and the Department of Natural Resources of Canada (“NRCan”):

1. Disclaimer and Limitation: Client agrees that its use of the Third Party Data is subject to the following provisions:

a. Disclaimer: The Third Party Data is licensed on an “as is” basis. The licensors of such data, including Her Majesty, Canada Post and NRCan, make no guarantees, representations or warranties respecting such data, either express or implied, arising by law or otherwise, including but not limited to, effectiveness, completeness, accuracy or fitness for a particular purpose.

b. Limitation on Liability: The Third Party Data licensors, including Her Majesty, Canada Post and NRCan, shall not be liable: (i) in respect of any claim, demand or action, irrespective of the nature of the cause of the claim, demand or action alleging any loss, injury or damages, direct or indirect, which may result from the use or possession of such Data; or (ii) in any way for loss of revenues or contracts, or any other consequential loss of any kind resulting from any defect in the Data.

2. Copyright Notice: In connection with each copy of all or any portion of the Data for the Territory of Canada, Client shall affix in a conspicuous manner the following copyright notice on at least one of: (i) the label for the storage media of the copy; (ii) the packaging for the copy; or (iii) other materials packaged with the copy, such as user manuals or end user license agreements: “This data includes information taken with permission from Canadian authorities, including © Her Majesty the Queen in Right of Canada, © Queen’s Printer for Ontario, © Canada Post Corporation, GeoBase®, © The Department of Natural Resources Canada. All rights reserved.”

3. End-User Terms: Except as otherwise agreed by the parties, in connection with the provision of any portion of the Data for the Territory of Canada to End-Users as may be authorized under the Agreement, Client shall provide such End-Users, in a reasonably conspicuous manner, with terms (set forth with other end user terms required to be provided under the Agreement, or as otherwise may be provided, by Client) which shall include the following provisions on behalf of the Third Party Data licensors, including Her Majesty, Canada Post and NRCan:

The Data may include or reflect data of licensors, including Her Majesty the Queen in the Right of Canada (“Her Majesty”), Canada Post Corporation (“Canada Post”) and the Department of Natural Resources Canada (“NRCan”). Such data is licensed on an “as is” basis. The licensors, including Her Majesty, Canada Post and NRCan, make no guarantees, representations or warranties respecting such data,

# Appendices

---

either express or implied, arising by law or otherwise, including but not limited to, effectiveness, completeness, accuracy or fitness for a particular purpose. The licensors, including Her Majesty, Canada Post and NRCan, shall not be liable in respect of any claim, demand or action, irrespective of the nature of the cause of the claim, demand or action alleging any loss, injury or damages, direct or indirect, which may result from the use or possession of the data or the Data. The licensors, including Her Majesty, Canada Post and NRCan, shall not be liable in any way for loss of revenues or contracts, or any other consequential loss of any kind resulting from any defect in the data or the Data.

End User shall indemnify and save harmless the licensors, including Her Majesty, Canada Post and NRCan, and their officers, employees and agents from and against any claim, demand or action, irrespective of the nature of the cause of the claim, demand or action, alleging loss, costs, expenses, damages or injuries (including injuries resulting in death) arising out of the use or possession of the data or the Data.

4. Additional Provisions: The terms contained in this Section are in addition to all of the rights and obligations of the parties under the Agreement. To the extent that any of the provisions of this Section are inconsistent with, or conflict with, any other provisions of the Agreement, the provisions of this Section shall prevail.

II. Mexico. The following provision applies to the Data for Mexico, which includes certain data from the Instituto Nacional de Estadística y Geografía (“INEGI”):

A. Any and all copies of the Data and/or packaging containing Data for Mexico shall contain the following notice: “Fuente: INEGI (Instituto Nacional de Estadística y Geografía)”

III. Latin America Territory

A. Third Party Notices. Any and all copies of the Data and/or packaging relating thereto shall include the respective Third Party Notices set forth below and used as described below corresponding to the Territory (or portion thereof) included in such copy:

Territory Notice

Argentina IGN “INSTITUTO GEOGRAFICO NACIONAL ARGENTINO”

Ecuador “INSTITUTO GEOGRAFICO MILITAR DEL ECUADOR AUTORIZACION N° IGM-2011-01- PCO-01 DEL 25 DE ENERO DE 2011”  
“source: © IGN 2009 - BD TOPO ®”

Guadeloupe, French Guiana and Martinique Mexico “Fuente: INEGI (Instituto Nacional de Estadística y Geografía)”

IV. Middle East Territory



# Appendices

---

A. Third Party Notices. Any and all copies of the Data and/or packaging relating thereto shall include the respective Third Party Notices set forth below and used as described below corresponding to the Territory (or portion thereof) included in such copy:

Country	Notice
Jordan	“© Royal Jordanian Geographic Centre”. The foregoing notice requirement for Jordan Data is a material term of the Agreement. If Client or any of its permitted sublicensees (if any) fail to meet such requirement, HERE shall have the right to terminate Client’s license with respect to the Jordan Data.

B. Jordan Data. Client and its permitted sublicensees (if any) are restricted from licensing and/or otherwise distributing HERE’s database for the country of Jordan (“Jordan Data”) for use in Enterprise Applications to (i) non-Jordanian entities for use of the Jordan Data solely in Jordan or (ii) Jordan-based customers. In addition, Client, its permitted sublicensees (if any) and End-Users are restricted from using the Jordan Data in Enterprise Applications if such party is (i) a non-Jordanian entity using the Jordan Data solely in Jordan or (ii) a Jordan-based customer. For purposes of the foregoing, “Enterprise Applications” shall mean Geomarketing applications, GIS applications, mobile business asset management applications, call center applications, telematics applications, public organization Internet applications or for providing geocoding services.

## V. Europe Territory

### A. Use of Certain Traffic Codes in Europe

1. General Restrictions Applicable to Traffic Codes. Client acknowledges and agrees that in certain countries of the Europe Territory, Client will need to obtain rights directly from third party RDS-TMC code providers to receive and use the Traffic Codes in the Data and to deliver to End-Users Transactions in any way derived from or based on such Traffic Codes. For such countries, HERE shall deliver the Data incorporating Traffic Codes to Client only after receiving certification from Client of its having obtained such rights.

2. Display of Third Party Rights Legends for Belgium. Client shall, for each Transaction that uses Traffic Codes for Belgium, provide the following notice to the End-User: “Traffic Codes for Belgium are provided by the Ministerie van de Vlaamse Gemeenschap and the Ministère de l’Equipeement et des Transports.”

B. Paper Maps. With respect to any license granted to Client relating to making, selling or distributing paper maps (i.e., a map fixed on a paper or paper-like medium): (a) such license with respect to Data for the Territory of Great Britain is conditioned on Client’s entering into and complying with a separate written agreement with the Ordnance Survey (“OS”) to create and sell paper maps, Client’s paying to the OS any and all applicable paper map royalties, and Client’s complying with the OS copyright notice requirements; (b) such license for selling or otherwise distributing for charge with respect to Data for the Territory of Czech Republic

# Appendices

is conditioned on Client's obtaining prior written consent from Kartografie a.s.; (c) such license for selling or distributing with respect to Data for the Territory of Switzerland is conditioned on Client's obtaining a permit from Bundesamt für Landestopografie of Switzerland; (d) Client is restricted from using Data for the Territory of France to create paper maps with a scale between 1:5,000 and 1:250,000; and (e) Client is restricted from using any Data to create, sell or distribute paper maps that are the same or substantially similar, in terms of data content and specific use of color, symbols and scale, to paper maps published by the European national mapping agencies, including without limitation, Landervermessungämter of Germany, Topografische Dienst of the Netherlands, Nationaal Geografisch Instituut of Belgium, Bundesamt für Landestopografie of Switzerland, Bundesamt für Eich- und Vermessungswesen of Austria, and the National Land Survey of Sweden.

C. OS Enforcement. Without limiting Section IV(B) above, with respect to Data for the Territory of Great Britain, Client acknowledges and agrees that the Ordnance Survey ("OS") may bring a direct action against Client to enforce compliance with the OS copyright notice (see Section IV(D) below) and paper map requirements (see Section IV(B) above) contained in this Agreement.

D. Third Party Notices. Any and all copies of the Data and/or packaging relating thereto shall include the respective Third Party Notices set forth below and used as described below corresponding to the Territory (or portion thereof) included in such copy:

Country(ies) Notice

Austria	"© Bundesamt für Eich- und Vermessungswesen"
Croatia Cyprus, Estonia, Latvia, Lithuania, Moldova, Poland, Slovenia and/or Ukraine	"© EuroGeographics"
France	"source: © IGN 2009 – BD TOPO ®"
Germany	"Die Grundlagendaten wurden mit Genehmigung der zuständigen Behörden entnommen"
Great Britain	"Contains Ordnance Survey data © Crown copyright and database right 2010 Contains Royal Mail data © Royal Mail copyright and database right 2010"
Greece	"Copyright Geomatics Ltd."
Hungary	"Copyright © 2003; Top-Map Ltd."
Italy	"La Banca Dati Italiana è stata prodotta usando quale riferimento anche cartografia numerica ed al tratto prodotta e fornita dalla Regione Toscana."
Norway	"Copyright © 2000; Norwegian Mapping Authority"
Portugal	"Source: IgeoE – Portugal"

# Appendices

Spain	“Información geográfica propiedad del CNIG”
Sweden	“Based upon electronic data © National Land Survey Sweden.”
Switzerland	“Topografische Grundlage: © Bundesamt für Landestopographie.”

E. Respective Country Distribution. Client acknowledges that HERE has not received approvals to distribute map data for the following countries in such respective countries: Albania, Belarus, Kyrgyzstan, Moldova and Uzbekistan. HERE may update such list from time to time. The license rights granted to Client under this TL with respect to the Data for such countries are contingent upon Client's compliance with all applicable laws and regulations, including, without limitation, any required licenses or approvals to distribute the Application incorporating such Data in such respective countries.

## VI. Australia Territory

A. Third Party Notices. Any and all copies of the Data and/or packaging relating thereto shall include the respective Third Party Notices set forth below and used as described below corresponding to the Territory (or portion thereof) included in such copy:

Copyright. Based on data provided under license from PSMA Australia Limited ([www.pasma.com.au](http://www.pasma.com.au)).

Product incorporates data which is © 20XX Telstra Corporation Limited, GM Holden Limited, Intelomatics Australia Pty Ltd and Continental Pty Ltd.

B. Third Party Notices for Australia. In addition to the foregoing, the End-User Terms for any Application containing RDS-TMC Traffic Codes for Australia shall contain the following notice: “Product incorporates traffic location codes which is © 20XX Telstra Corporation Limited and its licensors.”

## VII. China Territory

### *Personal Use Only*

You agree to use this Data together with [insert name of Client Application] for the solely personal, non-commercial purposes for which you were licensed, and not for service bureau, time-sharing or other similar purposes. Accordingly, but subject to the restrictions set forth in the following paragraphs, you may copy this Data only as necessary for your personal use to (i) view it, and (ii) save it, provided that you do not remove any copyright notices that appear and do not modify the Data in any way. You agree not to otherwise reproduce, copy, modify, decompile, disassemble or reverse engineer any portion of this Data, and may not transfer or distribute it in any form, for any purpose, except to the extent permitted by mandatory laws.

### *Restrictions*

Except where you have been specifically licensed to do so by NAV2 , and without limiting the preceding paragraph, you may not (a) use this Data with any products, systems, or applications installed or otherwise connected to or in communication with vehicles, capable of vehicle navigation, positioning, dispatch, real time route guidance, fleet management or similar applications; or (b)

# Appendices

---

with or in communication with any positioning devices or any mobile or wireless-connected electronic or computer devices, including without limitation cellular phones, palmtop and handheld computers, pagers, and personal digital assistants or PDAs. You agree to cease using this Data if you fail to comply with these terms and conditions.

## **Limited Warranty**

NAV2 warrants that (a) the Data will perform substantially in accordance with the accompanying written materials for a period of ninety (90) days from the date of receipt, and (b) any support services provided by NAV2 shall be substantially as described in applicable written materials provided to you by NAV2, and NAV2's support engineers will make commercially reasonable efforts to solve any problem issues.

## **rigCustomer Remedies**

NAV2 and its suppliers' entire liability and your exclusive remedy shall be, at NAV2's sole discretion, either (a) return of the price paid, if any, or (b) repair or replacement of the Data that do not meet NAV2's Limited Warranty and that are returned to NAV2 with a copy of your receipt. This Limited Warranty is void if failure of the Data has resulted from accident, abuse, or misapplication. Any replacement Data will be warranted for the remainder of the original warranty period or thirty (30) days, whichever is longer. Neither these remedies nor any product support services offered by NAV2 are available without proof of purchase from an authorized international source.

## **No Other Warranty:**

EXCEPT FOR THE LIMITED WARRANTY SET FORTH ABOVE AND TO THE EXTENT PERMITTED BY APPLICABLE LAW, NAV2 AND ITS LICENSORS (INCLUDING THEIR LICENSORS AND SUPPLIERS) DISCLAIM ANY WARRANTIES, EXPRESS OR IMPLIED, OF QUALITY, PERFORMANCE, MERCHANTABILITY, FITNESS FOR A PARTICULAR PURPOSE, OWNERSHIP OR NON-INFRINGEMENT. Certain warranty exclusions may not be permitted under applicable law, so to that extent the above exclusion may not apply to you.

## **Limited Liability:**

TO THE EXTENT PERMITTED BY APPLICABLE LAW, NAV2 AND ITS LICENSORS (INCLUDING THEIR LICENSORS AND SUPPLIERS) SHALL NOT BE LIABLE TO YOU: IN RESPECT OF ANY CLAIM, DEMAND OR ACTION, IRRESPECTIVE OF THE NATURE OF THE CAUSE OF THE CLAIM, DEMAND OR ACTION ALLEGING ANY LOSS, INJURY OR DAMAGES, DIRECT OR INDIRECT, WHICH MAY RESULT FROM THE USE OR POSSESSION OF THE INFORMATION; OR FOR ANY LOSS OF PROFIT, REVENUE, CONTRACTS OR SAVINGS, OR ANY OTHER DIRECT, INDIRECT, INCIDENTAL, SPECIAL OR CONSEQUENTIAL DAMAGES ARISING OUT OF YOUR USE OF OR INABILITY TO USE THIS INFORMATION, ANY DEFECT IN THE INFORMATION, OR THE BREACH OF THESE TERMS OR CONDITIONS, WHETHER IN AN ACTION IN CONTRACT OR TORT OR BASED ON A WARRANTY, EVEN IF NAV2 OR ITS LICENSORS HAVE BEEN ADVISED OF THE POSSIBILITY OF SUCH DAMAGES. UNDER NO CIRCUMSTANCES SHALL NAV2'S OR ITS SUPPLIERS' LIABILITY HEREUNDER EXCEED THE PRICE PAID. Certain liability exclusions may not be permitted under applicable law, so to that extent the above exclusion may not apply to you.

# Appendices

---

## **Export Control**

You agree not to export to anywhere any part of the Data provided to you or any direct product thereof except in compliance with, and with all licenses and approvals required under, applicable export laws, rules and regulations.

## **IP Protection**

The Data are owned by NAV2 or its suppliers and are protected by applicable copyright and other intellectual property law and treaties. The Data are provided solely on the basis of a license to use, not sale.

## **Entire Agreement**

These terms and conditions constitute the entire agreement between NAV2 (and its licensors, including their licensors and suppliers) and you pertaining to the subject matter hereof, and supersedes in their entirety any and all written or oral agreements previously existing between us with respect to such subject matter.

## **Governing Law.**

The above terms and conditions shall be governed by the laws of the People's Republic of China, without giving effect to (i) its conflict of laws provisions, or (ii) the United Nations Convention for Contracts for the International Sale of Goods, which is explicitly excluded. Any dispute arising from or in connection with the Data provided to you hereunder shall be submitted to the Shanghai International Economic and Trade Arbitration Commission for arbitration.

## **Gracenote® Copyright**

CD and music-related data from Gracenote, Inc., copyright©

2000-2007 Gracenote. Gracenote Software, copyright © 2000-2007 Gracenote. This product and service may practice one or more of the following U.S. Patents 5,987,525; 6,061,680; 6,154,773; 6,161,132; 6,230,192; 6,230,207; 6,240,459; 6,330,593 and other patents issued or pending. Some services supplied under license from Open Globe, Inc. for U.S. Patent 6,304,523.

Gracenote and CDDB are registered trademarks of Gracenote. The Gracenote logo and logotype, and the "Powered by Gracenote™" logo are trademarks of Gracenote.

## **Gracenote® End User License Agreement (EULA)**

This device contains software from Gracenote, Inc. of 2000 Powell Street Emeryville, California 94608 ("Gracenote").

The software from Gracenote (the "Gracenote Software") enables this device to do disc and music file identification and obtain music-related information, including name, artist, track, and title information ("Gracenote Data") from online servers ("Gracenote Servers"), and to perform other functions. You may use Gracenote Data only by means of the intended End User functions of this device. This device may contain content belonging to Gracenote's providers. If so, all of the restrictions set forth herein with respect to Gracenote Data shall also apply to such content and such content providers shall be entitled to all of the benefits and protections set forth herein that are available to Gracenote. You agree that you will use the content from Gracenote ("Gracenote Content"), Gracenote Data, the Gracenote Software, and Gracenote Servers for your own personal, non-commercial use only. You agree not to assign, copy, transfer or transmit the Gracenote Content, Gracenote Software

# Appendices

---

or any Gracenote Data (except in a Tag associated with a music file) to any third party. YOU AGREE NOT TO USE OR EXPLOIT GRACENOTE CONTENT, GRACENOTE DATA, THE GRACENOTE SOFTWARE, OR GRACENOTE SERVERS, EXCEPT AS EXPRESSLY PERMITTED HEREIN.

You agree that your non-exclusive licenses to use the Gracenote Content, Gracenote Data, the Gracenote Software, and Gracenote Servers will terminate if you violate these restrictions. If your licenses terminate, you agree to cease any and all use of the Gracenote Content, Gracenote Data, the Gracenote Software, and Gracenote Servers.

Gracenote, respectively, reserve all rights in Gracenote Data, the Gracenote Software, and the Gracenote Servers and Gracenote Content, including all ownership rights. Under no circumstances will either Gracenote become liable for any payment to you for any information that you provide, including any copyrighted material or music file information. You agree that Gracenote may enforce its respective rights, collectively or separately, under this agreement against you, directly in each company's own name.

Gracenote uses a unique identifier to track queries for statistical purposes. The purpose of a randomly assigned numeric identifier is to allow Gracenote to count queries without knowing anything about who you are. For more information, see the web page at [www.gracenote.com](http://www.gracenote.com) for the Gracenote Privacy Policy.

THE GRACENOTE SOFTWARE, EACH ITEM OF GRACENOTE DATA AND THE GRACENOTE CONTENT ARE LICENSED TO YOU "AS IS". NEITHER GRACENOTE MAKES ANY REPRESENTATIONS OR WARRANTIES, EXPRESS OR IMPLIED, REGARDING THE ACCURACY OF ANY GRACENOTE DATA FROM THE

GRACENOTE SERVERS OR GRACENOTE CONTENT. GRACENOTE COLLECTIVELY AND SEPARATELY RESERVE THE RIGHT TO DELETE DATA AND/OR CONTENT FROM THE COMPANIES' RESPECTIVE SERVERS OR, IN THE CASE OF GRACENOTE, CHANGE DATA CATEGORIES FOR ANY CAUSE THAT GRACENOTE DEEMS SUFFICIENT. NO WARRANTY IS MADE THAT EITHER GRACENOTE CONTENT OR THE GRACENOTE SOFTWARE OR GRACENOTE SERVERS ARE ERROR-FREE OR THAT THE FUNCTIONING OF THE GRACENOTE SOFTWARE OR GRACENOTE SERVERS WILL BE UNINTERRUPTED. GRACENOTE IS NOT OBLIGATED TO PROVIDE YOU WITH ANY ENHANCED OR ADDITIONAL DATA TYPES THAT GRACENOTE MAY CHOOSE TO PROVIDE IN THE FUTURE AND IS FREE TO DISCONTINUE ITS ONLINE SERVICES AT ANY TIME. GRACENOTE DISCLAIM ALL WARRANTIES EXPRESS OR IMPLIED, INCLUDING, BUT NOT LIMITED TO, IMPLIED WARRANTIES OF MERCHANTABILITY, FITNESS FOR A PARTICULAR PURPOSE, TITLE, AND NON-INFRINGEMENT. NEITHER GRACENOTE WARRANTS THE RESULTS THAT WILL BE OBTAINED BY YOUR USE OF THE GRACENOTE SOFTWARE OR ANY GRACENOTE SERVER. IN NO CASE WILL GRACENOTE BE LIABLE FOR ANY CONSEQUENTIAL OR INCIDENTAL DAMAGES OR FOR ANY LOST PROFITS OR LOST REVENUES FOR ANY REASON WHATSOEVER. © Gracenote 2007.

## **Radio Frequency Statement**

FCC ID: ACJ-SYNCG3-L

IC: 216B-SYNCG3-L

This device complies with Part 15 of the FCC Rules and with RSS-210 of Industry Canada. Operation is subject to the following two conditions:

# Appendices

(1) This device may not cause harmful interference, and

(2) this device must accept any interference received, including interference that may cause undesired operation.



**WARNING:** Changes or modifications not expressly approved by the party responsible for compliance could void the user's authority to operate the equipment. The term "IC:" before the radio certification number only signifies that Industry Canada technical specifications were met.

The antenna used for this transmitter must not be co-located or operating in conjunction with any other antenna or transmitter.

## Taiwan Territory

Note: In accordance with the management approach of low-power radio wave radiation motors:

Article 12: For approved and certified low-power radiation motor models, companies, firms or users must not alter the frequency, increase the power or change the characteristics and functions of the original design without authorization.

Article 14: The usage of low-power radio-frequency motors must not affect aviation safety and interfere with legal telecommunications. Should interference be detected, immediately stop using the device and only resume usage after ensuring that there is no longer any interference. For the legal telecommunication and wireless telecommunication of the telco, the low-power radio frequency motor must be able to tolerate legal limits of interference from telecommunication, industrial, scientific and radio wave equipment.

## SUNA TRAFFIC CHANNEL – TERMS AND CONDITIONS

By activating, using and/or accessing the SUNA Traffic Channel, SUNA Predictive or other content or material provided by Intelematics (together, **SUNA Products and/or Services**), you must accept certain terms and conditions. The following is a brief summary of the terms and conditions that apply to you. To view the full terms and conditions relevant to your use of the SUNA Products and/or Services, please consult:

Website
<a href="http://www.sunatrafic.com.au/termsandconditions/">www.sunatrafic.com.au/termsandconditions/</a>

### 1. Acceptance

By using SUNA Products and/or Services, you will be deemed to have accepted and agreed to be bound by the terms and conditions fully detailed at:

Website
<a href="http://www.sunatrafic.com.au/termsandconditions/">www.sunatrafic.com.au/termsandconditions/</a>

### 2. Intellectual Property

SUNA Products and/or Services are for your personal use. You may not record, or retransmit the content, nor use the content in association with any other traffic information or route guidance service or device not approved by Intelematics. You obtain no right of ownership in any Intellectual Property Rights (including copyright) in the data that is used to provide SUNA Products and/or Services.

### 3. Appropriate Use

# Appendices

---

SUNA Products and/or Services are intended as an aid to personal motoring and travel planning, and do not provide comprehensive or accurate information on all occasions. On occasions, you may experience additional delay as a result of using SUNA Products and/or Services. You acknowledge that it is not intended, or suitable, for use in applications where time of arrival or driving directions may impact the safety of the public or yourself.

## **4. Use of SUNA Products and Services while driving**

You, and other authorised drivers of the vehicle in which SUNA Products and/or Services are available or installed and active, remain at all times responsible for observing all relevant laws and codes of safe driving. In particular, you agree to only actively operate SUNA Products and/or Services when the Vehicle is at a complete stop and it is safe to do so.

## **5. Service Continuity and Reception of the SUNA Traffic Channel**

We will use reasonable endeavours to provide the SUNA Traffic Channel 24 hours a day, 365 days a year. The SUNA Traffic Channel may occasionally be unavailable for technical reasons or for planned maintenance. We will try to perform maintenance at times when congestion is light. We reserve the right to withdraw SUNA Products and/or Services at any time.

Also, we cannot assure the uninterrupted reception of the SUNA Traffic Channel RDS-TMC signal at any particular location.

## **6. Limitation of Liability**

Neither Intelematics (nor its suppliers or the manufacturer of your device (the “**Suppliers**”)) shall be liable to you or to any third party for any damages either direct, indirect, incidental, consequential or otherwise arising out of the use of or inability to use SUNA Products and/or

Services even if Intelematics or a Supplier has been advised of the possibility of such damages. You also acknowledge that the neither Intelematics nor any Supplier guarantees nor make any warranties that relate to the availability, accuracy or completeness of SUNA Products and/or Services, and to the extent which it is lawful to do so, both Intelematics and each Supplier excludes any warranties which might otherwise be implied by any State or Federal legislation in relation to SUNA Products and/or Services.

## **7. Please Note**

Great care has been taken in preparing this manual. Constant product development may mean that some information is not entirely up-to-date. The information in this document is subject to change without notice.

## **DECLARATION OF CONFORMITY**

Your vehicle could have components that transmit and receive radio waves and are therefore subject to government regulation.

These components must accept any interference received, including interference that could cause undesired operation. For certification labels and declarations of conformity, visit [www.wirelessconformity.ford.com](http://www.wirelessconformity.ford.com).



# Index

## 1

180 Degree Camera.....	266
180 Degree Camera Precautions.....	266

## A

### A/C

See: Climate Control.....	162
---------------------------	-----

About This Publication.....	18
Features and Options.....	18
Illustrations.....	18
Location of Components.....	18

### ABS

See: Brakes.....	244
------------------	-----

### ABS driving hints

See: Hints on Driving With Anti-Lock Brakes.....	245
---	-----

### Accessories

See: Replacement Parts Recommendation.....	17
---	----

### ACC

See: Using Adaptive Cruise Control - Vehicles With: 12.3 Inch Instrument Cluster Display Screen/Adaptive Cruise Control.....	294
--	-----

See: Using Adaptive Cruise Control - Vehicles With: 12.3 Inch Instrument Cluster Display Screen/Adaptive Cruise Control With Lane Centering.....	304
---	-----

See: Using Adaptive Cruise Control - Vehicles With: 4.2 Inch Instrument Cluster Display Screen/Adaptive Cruise Control.....	273
---	-----

See: Using Adaptive Cruise Control - Vehicles With: 4.2 Inch Instrument Cluster Display Screen/Adaptive Cruise Control With Lane Centering.....	282
--	-----

Acknowledgments.....	15
----------------------	----

Active Park Assist.....	267
-------------------------	-----

Active Park Assist – Troubleshooting.....	270
---	-----

Active Park Assist Precautions.....	267
-------------------------------------	-----

Active Park Assist – Troubleshooting.....	270
--	-----

Active Park Assist – Frequently Asked Questions.....	270
---	-----

Active Park Assist – Information Messages.....	270
---	-----

Adaptive Headlamps - Vehicles With: 12.3 Inch Instrument Cluster Display Screen.....	120
--	-----

Adaptive Headlamps Information Messages.....	121
---	-----

Adaptive Headlamps Settings.....	121
----------------------------------	-----

Camera Detects Lane Markings.....	121
-----------------------------------	-----

Camera Detects Traffic Signs.....	121
-----------------------------------	-----

Steering Around a Curve.....	120
------------------------------	-----

Adaptive Headlamps - Vehicles With: 4.2 Inch Instrument Cluster Display Screen.....	118
---	-----

Adaptive Headlamps Information Messages.....	120
---	-----

Adaptive Headlamps Settings.....	119
----------------------------------	-----

Camera Detects Lane Markings.....	118
-----------------------------------	-----

Camera Detects Traffic Signs.....	119
-----------------------------------	-----

Steering Around a Curve.....	118
------------------------------	-----

AdBlue® Capacity and Specification.....	231
--	-----

Adjusting the Exterior Mirrors.....	129
-------------------------------------	-----

Adjusting the Interior Mirror.....	128
------------------------------------	-----

Adjusting the Steering Wheel.....	97
-----------------------------------	----

### AFS

See: Adaptive Headlamps - Vehicles With: 12.3 Inch Instrument Cluster Display Screen.....	120
---	-----

See: Adaptive Headlamps - Vehicles With: 4.2 Inch Instrument Cluster Display Screen.....	118
--	-----

Air Conditioning See: Climate Control.....	162
---	-----

AM/FM Radio - Vehicles With: SYNC 2.5.....	507
---	-----

Using the Radio.....	507
----------------------	-----

AM/FM Radio - Vehicles Without: SYNC.....	507
--	-----

Selecting a Radio Source.....	507
-------------------------------	-----

Ambient Lighting.....	124
-----------------------	-----

Switching the Ambient Lamps On.....	124
-------------------------------------	-----

Anti-Theft Alarm System.....	92
------------------------------	----

Arming the Anti-Theft Alarm System.....	93
---	----

Disarming the Anti-Theft Alarm System.....	93
---	----

How Does the Anti-Theft Alarm System Work.....	92
---	----

What Are the Inclination Sensors.....	92
---------------------------------------	----

What Are the Interior Sensors.....	92
------------------------------------	----

# Index

What Is the Anti-Theft Alarm System.....	92
What Is the Battery Backup Alarm.....	93
What Is the Perimeter Alarm.....	92
Anti-Theft Alarm System Settings.....	93
Setting the Alarm Security Level.....	93
Switching Ask on Exit On and Off.....	94
What are the Alarm Security Levels.....	93
What Is Ask on Exit.....	94
Appendices.....	550
Apps.....	537
Using Apps on an Android Device.....	537
Using Apps on an iOS Device.....	537
Using Mobile Navigation on an Android Device.....	537
Apps - Vehicles With: SYNC 2.5.....	512
Apps Troubleshooting.....	514
Using Android Auto.....	513
Using Apple CarPlay.....	512
Using Apps on an Android Device.....	513
Using Apps on an iOS Device.....	513
Audio System.....	502
General Information.....	502
Audio System – Troubleshooting - Vehicles With: SYNC 2.5.....	516
Master Reset.....	517
Resetting the System.....	516
Updating the System.....	516
Audio Unit Clock and Date Displays - Vehicles With: SYNC 2.5.....	510
Audio Unit Clock and Date Displays - Vehicles Without: SYNC.....	510
Adjusting the Clock.....	510
Audio Unit - Vehicles With: SYNC 2.5.....	505
Adjusting the Volume.....	506
Changing Radio Stations.....	506
Next Track Button.....	506
Pausing or Playing Media.....	506
Previous Track Button.....	506
Sound Settings.....	506
Switching the Audio Unit On and Off.....	505
Switching the Screen On and Off.....	506
Audio Unit - Vehicles With: SYNC 3.....	504
Adjusting the Volume.....	504
Changing Radio Stations.....	505
Next Track Button.....	505
Pausing or Playing Media.....	505
Previous Track Button.....	505
Sound Settings.....	505
Switching the Audio Unit On and Off.....	504
Switching the Screen On and Off.....	505
Audio Unit - Vehicles Without: SYNC.....	502
Adjusting the Volume.....	502
Changing Radio Stations.....	503
Pausing or Playing Media.....	504
Returning to the Previous Screen.....	503
Scrolling Through the Menu Options.....	503
Seek Down and Previous Track Button.....	504
Seek Up and Next Track Button.....	503
Selecting a Menu Option.....	503
Selecting Media.....	503
Selecting the Radio.....	502
Sound Settings.....	504
Switching the Audio Unit On and Off.....	502
Switching the Screen On and Off.....	504
System Settings.....	504
Using a Cell Phone.....	504
Auto-Dimming Interior Mirror.....	128
Auto-Dimming Interior Mirror Precautions.....	128
What Is the Auto-Dimming Interior Mirror.....	128
Auto Hold.....	252
Auto Hold Indicator.....	252
Auto Hold Information Messages.....	253
Switching Auto Hold On and Off.....	252
Using Auto Hold.....	252
Autolamps - Vehicles With: 12.3 Inch Instrument Cluster Display Screen.....	108
Adjusting the Period of Time That the Headlamps Remain On.....	109
Autolamps - Vehicles With: 4.2 Inch Instrument Cluster Display Screen.....	108
Adjusting the Period of Time That the Headlamps Remain On.....	108
Automatic Climate Control.....	163
Directing Air to the Footwell Air Vents.....	164
Directing Air to the Instrument Panel Air Vents.....	164

# Index

Directing Air to the Windshield Air Vents.....	164
Setting the Blower Motor Speed.....	164
Setting the Temperature.....	165
Switching Auto Mode On and Off.....	163
Switching Dual Mode On and Off.....	164
Switching Maximum Cooling On and Off.....	163
Switching Maximum Defrost On and Off.....	163
Switching the Air Conditioning On and Off.....	163
Switching the Climate Control On and Off.....	163
Switching the Recirculated Air On and Off.....	163
Automatic Crash Notification System.....	57
Automatic Crash Shutoff.....	394
Automatic Crash Shutoff Precautions.....	394
Re-Enabling Your Vehicle.....	394
What Is Automatic Crash Shutoff.....	394
Automatic Engine Stop - Vehicles With: Push Button Start.....	199
How Does Automatic Engine Stop Work.....	199
Overriding Automatic Engine Stop.....	199
Switching Automatic Engine Stop On and Off.....	199
Automatic High Beam Control - Vehicles With: 12.3 Inch Instrument Cluster	
Display Screen.....	111
About Automatic High Beam Control.....	111
Automatic High Beam Control Information Messages.....	112
Automatic High Beam Indicator.....	112
Overriding Automatic High Beam Control.....	112
Switching Automatic High Beam Control On or Off.....	112
Automatic High Beam Control - Vehicles With: 4.2 Inch Instrument Cluster	
Display Screen.....	109
About Automatic High Beam Control.....	110
Automatic High Beam Control Information Messages.....	111
Automatic High Beam Indicator.....	110
Overriding Automatic High Beam Control.....	110
Switching Automatic High Beam Control On or Off.....	110
Automatic Return to Park (P) - 8-Speed Automatic Transmission.....	240
Automatic Return to Park (P) Limitations.....	240
How Does Automatic Return to Park (P) Work.....	240
What Is Automatic Return to Park (P).....	240
Automatic Transmission Audible Warnings.....	241
Transmission Not in Park (P) Audible Warning.....	241
Automatic Transmission.....	237
Automatic Return to Park (P) - 8-Speed Automatic Transmission.....	240
Automatic Transmission Positions.....	237
Automatic Transmission - Troubleshooting.....	242
Brake Shift Interlock - 6-Speed Automatic Transmission.....	240
Manually Shifting Gears - Vehicles With: Paddle Shifters.....	238
Stay in Neutral Mode - 8-Speed Automatic Transmission.....	239
Automatic Transmission Position Indicators - Vehicles With: Paddle Shifters.....	238
Automatic Transmission Position Indicators - Vehicles Without: Paddle Shifters.....	237
Automatic Transmission Positions.....	237
Drive (D).....	237
Low (L).....	237
Manual (M).....	237
Neutral (N).....	237
Park (P).....	237
Reverse (R).....	237
Automatic Transmission Precautions.....	237
Automatic Transmission Shift Indicators - Vehicles With: Paddle Shifters.....	238

# Index

Automatic Transmission – Troubleshooting.....	242
Automatic Transmission – Information Messages.....	242
Autorelock.....	81
How Does Autorelock Work.....	81
Auto-Start-Stop Audible Warning.....	209
Auto-Start-Stop.....	205
Auto-Start-Stop Settings.....	211
Auto-Start-Stop – Troubleshooting.....	206
Auto-Start-Stop Indicators.....	206
Auto-Start-Stop Precautions.....	205
Auto-Start-Stop Settings.....	211
Setting the Engine Stop Speed.....	211
Auto-Start-Stop – Troubleshooting.....	206
Auto-Start-Stop – Frequently Asked Questions.....	207
Auto-Start-Stop – Information Messages.....	206
Autounlock.....	80
Autounlock Requirements.....	80
Switching Autounlock On and Off.....	80
What Is Autounlock.....	80
Autowipers - Vehicles With: 12.3 Inch Instrument Cluster Display Screen.....	101
Autowiper Settings.....	102
Autowipers - Vehicles With: 4.2 Inch Instrument Cluster Display Screen.....	99
Settings.....	100
Auxiliary Heater - Vehicles With: 12.3 Inch Instrument Cluster Display Screen.....	172
Parking Heater.....	172
Principle of Operation.....	172
Using the Auxiliary Heater.....	172
Auxiliary Heater - Vehicles With: 4.2 Inch Instrument Cluster Display Screen.....	167
Parking Heater.....	168
Principle of Operation.....	167
Using the Auxiliary Heater.....	167
Auxiliary Power Points.....	188

## B

Battery	
See: Changing the 12V Battery.....	428
Blind Spot Information System.....	327
Blind Spot Information System Indicator.....	328
Blind Spot Information System Information Messages.....	329
Blind Spot Information System Sensors.....	328
Switching the Blind Spot Information System On and Off.....	328
Using the Blind Spot Information System.....	327
BLIS	
See: Blind Spot Information System.....	327
Bonnet Lock	
See: Opening and Closing the Hood - LHD.....	404
See: Opening and Closing the Hood - RHD.....	406
Brake Fluid Check.....	427
Brakes.....	244
General Information.....	244
Brake Shift Interlock – 6-Speed Automatic Transmission.....	240
Brake Shift Interlock Precautions.....	240
Using Brake Shift Interlock.....	241
What Is Brake Shift Interlock.....	240
Breaking-In.....	388
Brakes and Clutch.....	388
Tires.....	388
Bulb Specification Chart.....	489

## C

Capacities and Specifications - 1.0L EcoBoost™.....	476
Brake System.....	478
Engine.....	477
Fuel Tank.....	478
Washer Reservoir.....	478
Capacities and Specifications - 1.5L EcoBlue.....	480
AdBlue® Tank.....	482
Brake System.....	482
Engine.....	481

# Index

Fuel Tank.....	482	Center Console - Automatic Transmission, Vehicles With: Front Parking Aid/Head Up Display (HUD)/ Rear Parking Aid, Vehicles Without: Active Park Assist, Excluding: ST.....	27
Washer Reservoir.....	482	Center Console - Automatic Transmission, Vehicles With: Front Parking Aid/Rear Parking Aid, Vehicles Without: Active Park Assist/Head Up Display (HUD), Excluding: ST.....	28
Capacities and Specifications - 1.5L		Center Console - Automatic Transmission, Vehicles With: Head Up Display (HUD), Vehicles Without: Active Park Assist/Front Parking Aid/ Rear Parking Aid, Excluding: ST.....	28
EcoBoost™.....	483	Center Console - Automatic Transmission, Vehicles Without: Active Park Assist/Front Parking Aid/Head Up Display (HUD)/Rear Parking Aid, Excluding: ST.....	27
Brake System.....	484	Center Console - Manual Transmission, LHD, Excluding: ST.....	30
Engine.....	483	Center Console - Manual Transmission, RHD, Excluding: ST.....	30
Fuel Tank.....	484	Center Console - ST, Automatic Transmission, Vehicles With: Active Park Assist/Front Parking Aid/Head Up Display (HUD)/Rear Parking Aid.....	33
Washer Reservoir.....	484	Center Console - ST, Automatic Transmission, Vehicles With: Active Park Assist/Front Parking Aid/Rear Parking Aid, Vehicles Without: Head Up Display (HUD).....	31
Capacities and Specifications - 1.5L		Center Console - ST, Automatic Transmission, Vehicles With: Front Parking Aid/Head Up Display (HUD)/ Rear Parking Aid, Vehicles Without: Active Park Assist.....	31
TiVCT.....	478	Center Console - ST, Automatic Transmission, Vehicles With: Front Parking Aid/Rear Parking Aid, Vehicles Without: Active Park Assist/Head Up Display (HUD).....	33
Brake System.....	480	Center Console - ST, Automatic Transmission, Vehicles With: Head Up Display (HUD), Vehicles Without: Active Park Assist/Front Parking Aid/ Rear Parking Aid.....	32
Engine.....	479		
Fuel Tank.....	480		
Washer Reservoir.....	480		
Capacities and Specifications - 2.0L			
EcoBlue.....	485		
AdBlue® Tank.....	486		
Brake System.....	486		
Engine.....	485		
Fuel Tank.....	486		
Washer Reservoir.....	486		
Capacities and Specifications - 2.3L			
EcoBoost™.....	487		
Brake System.....	488		
Engine.....	487		
Fuel Tank.....	488		
Washer Reservoir.....	488		
Capacities and Specifications.....	467		
Cargo Nets - Wagon.....	372		
Luggage Retention Net.....	372		
Catalytic Converter - 1.0L EcoBoost™/ 1.5L EcoBoost™/1.5L TiVCT/2.3L EcoBoost™.....	223		
On-Board Diagnostics System.....	223		
Center Console - Automatic Transmission, Vehicles With: Active Park Assist/Front Parking Aid/Head Up Display (HUD)/Rear Parking Aid, Excluding: ST.....	29		
Center Console - Automatic Transmission, Vehicles With: Active Park Assist/Front Parking Aid/Rear Parking Aid, Vehicles Without: Head Up Display (HUD), Excluding: ST.....	29		

# Index

Center Console - ST, Automatic Transmission, Vehicles Without: Active Park Assist/Front Parking Aid/Head Up Display (HUD)/Rear Parking Aid.....	32
Center Console - ST, Manual Transmission, LHD.....	34
Center Console - ST, Manual Transmission, RHD.....	34
Changing a Bulb.....	434
Front Fog Lamp.....	436
Headlamp.....	434
Rear Lamp.....	436
Changing a Fuse.....	402
Engine Compartment Fuse Box.....	402
Fuse Types.....	403
General Information.....	402
Passenger Compartment Fuse Box.....	403
Trailer Tow Module Fuse Box - 5-Door and Wagon.....	403
Changing a Road Wheel.....	451
Dissimilar Spare Wheel and Tire Assembly Information.....	451
Installing a Road Wheel.....	456
Removing a Road Wheel.....	455
Removing the Spare Wheel, Vehicle Jack and Lug Nut Tool.....	453
Removing the Wheel Trim.....	454
Vehicle Jack.....	454
Vehicle Jacking Points.....	455
Changing the 12V Battery.....	428
Remove and Reinstall the Battery.....	429
Changing the Backup Battery.....	62
Changing the Front Wiper Blades.....	430
Changing the Rear Wiper Blades.....	430
Changing the Remote Control Battery - Vehicles With: Keyless Entry.....	64
Changing the Remote Control Battery - Vehicles With: Remote Flip Key.....	65
Changing the Vehicle Wi-Fi Hotspot Name or Password.....	501
Charging a Wireless Device.....	189
Checking Local Hazard Information Status - Vehicles With: 12.3 Inch Instrument Cluster Display Screen.....	369
Checking Local Hazard Information Status - Vehicles With: 4.2 Inch Instrument Cluster Display Screen.....	369
Checking MyKey System Status - Vehicles With: 12.3 Inch Instrument Cluster Display Screen.....	72
Checking MyKey System Status - Vehicles With: 4.2 Inch Instrument Cluster Display Screen.....	72
Checking the Clutch Fluid Level.....	235
Checking the Selective Catalytic Reduction Fluid Level - Vehicles With: 12.3 Inch Instrument Cluster Display Screen.....	231
Checking the Selective Catalytic Reduction Fluid Level - Vehicles With: 4.2 Inch Instrument Cluster Display Screen.....	231
Checking the Wiper Blades.....	430
Child Restraint Positioning.....	43
Child Safety.....	35
Child Safety Locks - Vehicles With: Mechanical Child Proof Locks.....	47
Left-Hand Side.....	47
Right-Hand Side.....	47
Child Safety Locks - Vehicles With: Remote Child Proof Locks.....	47
Child Safety Locks Information Messages.....	47
Cigar Lighter.....	188
Cleaning the Exterior.....	440
Cleaning Camera Lenses and Sensors.....	441
Cleaning Chrome, Aluminium or Stainless Steel.....	440
Cleaning Headlamps and Rear Lamps.....	440
Cleaning Stripes or Graphics.....	441
Cleaning the Engine Compartment.....	441
Cleaning the Exterior Precautions.....	440
Cleaning the Underbody.....	441
Cleaning Wheels.....	440
Cleaning Windows and Wiper Blades.....	440
Cleaning the Interior.....	441
Cleaning Carpets and Floor Mats.....	442
Cleaning Displays and Screens.....	442

# Index

Cleaning Fabric Seats and Headliners.....	442
Cleaning Leather and Vinyl.....	442
Cleaning Moonroof Tracks.....	443
Cleaning Plastic.....	442
Cleaning Seatbelts.....	443
Cleaning Storage Compartments.....	443
Cleaning the Instrument Panel.....	441
Clearing All MyKeys - Vehicles With: 12.3 Inch Instrument Cluster Display Screen.....	71
Clearing All MyKeys - Vehicles With: 4.2 Inch Instrument Cluster Display Screen.....	71
Climate.....	528
Accessing Rear Climate Controls.....	530
Accessing the Climate Control Menu.....	528
Directing the Airflow.....	528
Rear Climate Control Lock Indicator.....	530
Setting the Blower Motor Speed.....	529
Setting the Temperature.....	529
Switching Auto Mode On and Off.....	529
Switching Dual Zone Mode On and Off.....	529
Switching Maximum Air Conditioning On and Off.....	530
Switching Maximum Defrost On and Off.....	530
Switching Rear Auto Mode On and Off.....	531
Switching Recirculated Air On and Off.....	530
Switching the Air Conditioning On and Off.....	529
Switching the Climate Controlled Seats On and Off.....	529
Switching the Climate Control On and Off.....	529
Switching the Heated Exterior Mirrors On and Off.....	529
Switching the Heated Rear Window On and Off.....	530
Switching the Heated Seats On and Off.....	530
Switching the Heated Steering Wheel On and Off.....	530
Switching the Heated Windshield On and Off.....	530
Switching the Rear Climate Controlled Seats On and Off.....	531
Switching the Rear Heated Seats On and Off.....	531
Switching the Rear Ventilated Seats On and Off.....	531
Switching the Ventilated Seats On and Off.....	530
Climate Control.....	162
Clutch Fluid Check - Manual Transmission.....	428
Clutch Fluid Specification.....	235
Cold Weather Precautions.....	388
Connected Vehicle.....	497
Connecting the Vehicle to a Mobile Network.....	497
Connected Vehicle Data - Vehicles With: Modem.....	21
Connected Vehicle Limitations.....	497
Connected Vehicle Requirements.....	497
Connected Vehicle - Troubleshooting - Vehicles With: Modem.....	498
Connected Vehicle - Troubleshooting - Vehicles With: SYNC 3/SYNC 2.5.....	499
Connecting a Bluetooth® Device - Vehicles With: SYNC 2.5.....	510
Connecting a Bluetooth® Device - Vehicles Without: SYNC.....	510
Pairing a Device.....	510
Connecting the Vehicle to a Mobile Network.....	497
Connecting FordPass to the Modem.....	497
Enabling and Disabling the Modem.....	497
What Is the Modem.....	497
Connecting the Vehicle to a Wi-Fi Network.....	497
Coolant Check See: Engine Coolant Check.....	423
Cornering Lamps.....	122
Crash and Breakdown Information.....	394
Automatic Crash Shutoff.....	394
Post-Crash Alert System.....	394
Post Impact Braking.....	394

# Index

Creating a MyKey - Vehicles With: 12.3 Inch Instrument Cluster Display Screen, Vehicles Without: Push Button Start.....	69
Creating a MyKey - Vehicles With: 12.3 Inch Instrument Cluster Display Screen/Keyless Entry/Push Button Start.....	70
Creating a MyKey - Vehicles With: 4.2 Inch Instrument Cluster Display Screen, Vehicles Without: Push Button Start.....	69
Creating a MyKey - Vehicles With: 4.2 Inch Instrument Cluster Display Screen/Keyless Entry/Push Button Start.....	70
Creating a Vehicle Wi-Fi Hotspot.....	501
Connecting a Device to the Wi-Fi Hotspot.....	501
Finding the Wi-Fi Hotspot Name and Password.....	501
Cross Traffic Alert.....	329
Cross Traffic Alert Indicator.....	331
Cross Traffic Alert Information Messages.....	332
Cross Traffic Alert System Limitations.....	331
Cross Traffic Alert System Sensors.....	331
Switching Cross Traffic Alert On and Off.....	355
Switching Cross Traffic Alert On or Off.....	331
Using Cross Traffic Alert.....	329
Cruise Control.....	272
Principle of Operation.....	272
Cruise control See: Using Cruise Control.....	272
Cup Holders.....	191
<b>D</b>	
Data Privacy.....	19
Services That Third Parties Provide.....	19
Services That We Provide.....	19
Declaration of Conformity.....	580
Diesel Particulate Filter.....	225
Diesel Particulate Filter Automatic Regeneration.....	226
On-Board Diagnostics System.....	226
Digital Radio - Vehicles With: SYNC 2.5.....	509
Using the Radio.....	509
Digital Radio - Vehicles Without: SYNC.....	508
Selecting a Radio Source.....	508
Direction Indicators.....	122
Direction Indicator.....	123
Switching the Direction Indicators On and Off.....	122
Displaying the Efficient Drive Mode - Vehicles With: 4.2 Inch Instrument Cluster Display Screen.....	367
Door Edge Protection.....	96
Principle of Operation.....	96
Door Lock Indicators.....	81
Door Lock Switch Inhibitor.....	79
How Does the Door Lock Switch Inhibitor Work.....	79
Doors and Locks Audible Warnings.....	81
Door Ajar Audible Warning.....	81
Doors and Locks.....	76
Autorelock.....	81
Autounlock.....	80
Door Lock Switch Inhibitor.....	79
Doors and Locks – Troubleshooting.....	81
Mislock.....	80
Operating the Doors From Inside Your Vehicle.....	78
Operating the Doors From Outside Your Vehicle.....	76
Doors and Locks – Troubleshooting.....	81
Doors and Locks – Information Messages.....	82
Doors and Locks – Warning Lamps.....	81
Drive Mode Control.....	365
Drive Mode Control – Troubleshooting.....	366
Drive Modes.....	365
Drive Mode Control – Troubleshooting.....	366
Drive Mode Control – Information Messages.....	366
Drive Modes.....	365
Comfort.....	365
Eco.....	365
Eco Comfort.....	365



# Index

Normal.....	365	Releasing the Electric Parking Brake if the Vehicle Battery is Running Out of Charge.....	249
Slippery.....	365	Electric Parking Brake - Manual Transmission.....	245
Sport.....	365	Applying the Electric Parking Brake.....	245
Track.....	366	Automatically Releasing the Electric Parking Brake.....	246
Trail.....	366	Electric Parking Brake Information Messages.....	247
Driver Airbag.....	52	Manually Releasing the Electric Parking Brake.....	246
Airbag Secondary Warning Audible Warning.....	53	Releasing the Electric Parking Brake if the Vehicle Battery is Running Out of Charge.....	246
Airbag Warning Lamp.....	52	Electromagnetic Compatibility.....	550
Driver Alert.....	322	Electronic Limited-Slip Differential.....	243
Driver Alert Limitations.....	347	Electronic Limited-Slip Differential – Troubleshooting.....	243
Driver Alert System Display.....	322	Electronic Limited-Slip Differential – Troubleshooting.....	243
Driver Alert System Messages.....	323	Electronic Limited-Slip Differential – Information Messages.....	243
Driver Alert System Warnings.....	322	Emergency Assistance.....	57
Switching Driver Alert On and Off.....	323	Emergency Call Indicators.....	61
Driving Aids.....	317	Emergency Call Limitations.....	60
Driving Economically.....	388	Emergency Call Requirements.....	60
Driving Hints.....	388	Emergency Call System Data.....	22
Driving Through Shallow Water.....	388	Enabling Local Hazard Information.....	369
<b>E</b>		Enabling Remote Start - Vehicles With: 12.3 Inch Instrument Cluster Display Screen.....	158
eCall.....	60	Enabling Remote Start - Vehicles With: 4.2 Inch Instrument Cluster Display Screen.....	158
eCall – Troubleshooting.....	62	End User License Agreement.....	556
eCall – Information Messages.....	62	VEHICLE SOFTWARE END USER LICENSE AGREEMENT (EULA) .....	556
eCall User Information.....	553	Engine Coolant Check.....	423
eCall User Information According to Regulation (EU) 2017/78, Annex I, Part 3.....	553	Adding Coolant.....	424
Eco.....	337	Coolant Change.....	425
Eco Mode.....	337	Engine Coolant Temperature Management.....	427
Eco Mode System Display.....	359	Fail-Safe Cooling.....	426
Principle of Operation.....	359	Recycled Coolant.....	425
Efficient Drive Mode.....	367	Severe Climates.....	425
Trip Summary.....	367		
Efficient Drive Mode Indicators.....	368		
Electric Parking Brake – Automatic Transmission.....	247		
Applying the Electric Parking Brake.....	248		
Automatically Releasing the Electric Parking Brake.....	248		
Electric Parking Brake Information Messages.....	249		
Manually Releasing the Electric Parking Brake.....	248		

# Index

Engine Cooling Fan - Diesel.....	423
Engine Cooling Fan - Gasoline.....	423
Engine Emission Control.....	223
Engine Oil Check.....	421
Adding Engine Oil.....	421
Engine Oil Pressure Warning Lamp.....	421
Engine Oil Dipstick - 1.0L EcoBoost™/1.5L TiVCT.....	420
Engine Oil Dipstick - 1.5L EcoBlue.....	420
Engine Oil Dipstick - 1.5L EcoBoost™.....	420
Engine Oil Dipstick - 2.0L EcoBlue.....	420
Engine Oil Dipstick - 2.3L EcoBoost™.....	421
Entering a Parallel Parking Space - 6-Speed Automatic Transmission/6-Speed Manual Transmission.....	267
Entering a Parallel Parking Space - 8-Speed Automatic Transmission.....	268
Entering a Perpendicular Parking Space - 6-Speed Automatic Transmission/6-Speed Manual Transmission.....	268
Entering a Perpendicular Parking Space - 8-Speed Automatic Transmission.....	269
Entertainment.....	526
Playing Music From a USB or Media Player.....	528
Streaming Music From a Bluetooth Device.....	527
Using the Radio.....	526
Environment.....	23
EPB	
See: Electric Parking Brake - Automatic Transmission.....	247
See: Electric Parking Brake - Manual Transmission.....	245
Event Data.....	20
Exiting a Parking Space - 6-Speed Automatic Transmission/6-Speed Manual Transmission.....	269
Exiting a Parking Space - 8-Speed Automatic Transmission.....	270
Exterior Mirrors.....	129

## F

Fan	
See: Engine Cooling Fan - Diesel.....	423
See: Engine Cooling Fan - Gasoline.....	423
Fastening the Seatbelts.....	48
Using Seatbelts During Pregnancy.....	48
Filling the Selective Catalytic Reduction System Tank.....	229
Filling the Selective Catalytic Reduction System Tank in Cold Weather.....	229
Filling the Selective Catalytic Reduction System Tank Using a Fuel Station Pump.....	229
Filling the Selective Catalytic Reduction System Tank Using a Portable Container.....	230
First Aid Kit.....	390
Flat Tire	
See: Changing a Road Wheel.....	451
Flat Tire Inflation	
See: Tire Sealant and Inflator Kit.....	444
Floor Mats.....	389
Fog Lamps - Front	
See: Front Fog Lamps.....	117
Fog Lamps - Rear	
See: Rear Fog Lamps.....	117
Folding the Exterior Mirrors - Vehicles With: 12.3 Inch Instrument Cluster Display Screen/Power Fold Exterior Mirrors.....	129
Switching Auto-fold On and Off.....	130
Folding the Exterior Mirrors - Vehicles With: 4.2 Inch Instrument Cluster Display Screen/Power Fold Exterior Mirrors.....	129
Switching Auto-fold On and Off.....	129
Folding the Exterior Mirrors - Vehicles With: Manual Fold Exterior Mirrors.....	130
Front Fog Lamps.....	117
Front Fog Lamp Indicator.....	117
Switching the Front Fog Lamps On or Off.....	117
Front Parking Aid.....	258
Front Parking Aid Audible Warnings.....	259
Front Parking Aid Limitations.....	259

# Index

Locating the Front Parking Aid Sensors.....	259
What is the Front Parking Aid.....	258
Front Wiper Blades	
See: Changing the Front Wiper Blades.....	430
Fuel and Refueling.....	215
Fuel Burning Heater	
See: Auxiliary Heater - Vehicles With: 12.3 Inch Instrument Cluster Display Screen.....	172
See: Auxiliary Heater - Vehicles With: 4.2 Inch Instrument Cluster Display Screen.....	167
Fuel Consumption Figures - 1.0L EcoBoost™.....	491
Fuel Consumption Figures - 1.5L EcoBlue.....	493
Fuel Consumption Figures - 1.5L EcoBoost™.....	494
Fuel Consumption Figures - 1.5L TiVCT.....	492
Fuel Consumption Figures - 2.0L EcoBlue.....	495
Fuel Consumption Figures - 2.3L EcoBoost™.....	496
Fuel Consumption Figures.....	491
European Directive 1999/94/EC.....	491
Fuel Economy and CO2 Emissions.....	491
Fuel Consumption.....	221
Advertised Capacity.....	222
Fuel Economy.....	222
Fuel Filler Funnel Location.....	217
Fuel Quality - Diesel.....	216
Long-Term Storage.....	216
Fuel Quality - E85.....	216
Choosing the Right Fuel - Flex Fuel Vehicles.....	216
Long-Term Storage.....	217
Fuel Quality - Gasoline.....	215
Long-Term Storage.....	216
Fuse Box Locations.....	396
Engine Compartment Fuse Box.....	396
Passenger Compartment Fuse Box.....	396
Trailer Tow Module Fuse Box - 5-Door and Wagon.....	396
Fuses.....	396
Fuse Specification Chart.....	397
Engine Compartment Fuse Box.....	397
Passenger Compartment Fuse Box.....	400
Trailer Tow Module Fuse Box - 5-Door and Wagon.....	402
<b>G</b>	
Gasoline Particulate Filter.....	223
Gasoline Particulate Filter Information Messages.....	225
Gasoline Particulate Filter Regeneration.....	224
Gasoline Particulate Filter Warning Lamps and Indicators.....	224
Gauges - Excluding: Mild Hybrid Electric Vehicle (MHEV)/ST.....	133
Automatic Transmission Position Indicators.....	135
Engine Coolant Temperature Gauge.....	134
Fuel Gauge.....	134
Information Bar.....	138
Information Display.....	133
Instrument Cluster.....	133
Speedometer.....	134
Tachometer.....	133
Gauges - Mild Hybrid Electric Vehicle (MHEV).....	135
Automatic Transmission Gearshift Lever Position Indicator.....	137
Engine Coolant Temperature Gauge.....	137
Fuel Gauge.....	136
Hybrid Gauge.....	137
Information Bar.....	140
Information Display.....	135
Instrument Cluster.....	135
Speedometer.....	136
Tachometer.....	135
Gauges - ST.....	142
Engine Coolant Temperature Gauge.....	144
Fuel Gauge.....	143
Information Bar.....	143
Information Display.....	143
Instrument Cluster.....	142
Speedometer.....	143
Tachometer.....	143
Glare-Free High Beam - Vehicles With: 12.3 Inch Instrument Cluster Display Screen.....	115
About Glare-Free High Beam.....	115
Glare-Free High Beam Indicator.....	116

# Index

Glare-Free High Beam Information	
Messages.....	116
Overriding Glare-Free High Beam.....	116
Switching Glare-Free High Beam On or Off.....	116
Glare-Free High Beam - Vehicles With: 4.2 Inch Instrument Cluster Display	
Screen.....	112
About Glare-Free High Beam.....	113
Glare-Free High Beam Indicator.....	114
Glare-Free High Beam Information	
Messages.....	114
Overriding Glare-Free High Beam.....	114
Switching Glare-Free High Beam On or Off.....	114
Global Opening and Closing.....	125
Switching Global Closing On and Off.....	126
Switching Global Opening On and Off.....	126
Using Global Closing.....	126
Using Global Opening.....	125
What Is Global Opening and Closing.....	125
<b>H</b>	
Hands-Free Power Liftgate.....	90
Liftgate Ajar Information Messages.....	91
Liftgate Ajar Warning Lamp.....	91
Hazard Flashers.....	390
Hazard Flasher Indicator.....	390
Switching the Hazard Flashers On or Off.....	390
Headlamp Exit Delay.....	109
Headlamp Leveling.....	117
Headlamp Removal	
See: Removing a Headlamp.....	431
Headlamp Washers.....	105
Headrest	
See: Head Restraints.....	177
Head Restraints.....	177
Adjusting the Head Restraints.....	178
Removing the Head Restraints.....	178
Head Up Display.....	150
Adjusting the Head Up Display	
Settings.....	150
Cleaning the Head Up Display.....	150
Head Up Display Indicator.....	152
Head Up Display Information	
Messages.....	152
Selecting Which Information the System Displays.....	151
Switching the Head Up Display On or Off.....	150
Heated Exterior Mirrors.....	167
Heated Rear Window - Vehicles With: Automatic Temperature Control.....	167
Heated Rear Window - Vehicles With: Manual Temperature Control.....	167
Heated Seats.....	185
Heated Steering Wheel.....	98
Heated Windshield.....	166
Heating	
See: Climate Control.....	162
Hill Start Assist - Vehicles With: 12.3 Inch Instrument Cluster Display	
Screen.....	251
Hill Start Assist Information	
Messages.....	252
Switching Hill Start Assist On or Off.....	251
Using Hill Start Assist.....	251
Hill Start Assist - Vehicles With: 4.2 Inch Instrument Cluster Display	
Screen.....	250
Hill Start Assist Information	
Messages.....	251
Switching Hill Start Assist On or Off.....	250
Using Hill Start Assist.....	250
Hints on Controlling the Interior Climate - Vehicles With: Automatic Temperature Control.....	165
Defogging or Clearing the Windshield of Thin Ice.....	166
Defogging the Side Windows in Cold Weather.....	166
General Hints.....	165
Quickly Cooling the Interior.....	165
Recommended Settings for Cooling.....	166
Recommended Settings for Heating.....	165
Hints on Controlling the Interior Climate - Vehicles With: Manual Temperature Control.....	166
Defogging or Clearing the Windshield of Thin Ice.....	166
Defogging the Side Windows in Cold Weather.....	166

# Index

General Hints.....	166	Child Restraints for Different Mass Groups.....	40
Quickly Cooling the Interior.....	166	ISOFIX Anchor Points.....	42
Quickly Heating the Interior.....	166	Top Tether Anchor Points.....	42
Recommended Settings for Cooling.....	166	Instrument Cluster.....	133
Recommended Settings for Heating.....	166	Instrument Lighting Dimmer.....	109
Hints on Driving With Anti-Lock Brakes.....	245	Instrument Panel - LHD.....	25
Anti-Lock Brake System Warning Lamp.....	245	Instrument Panel - RHD.....	26
Hood Lock See: Opening and Closing the Hood - LHD.....	404	Intelligent Speed Limiter - Vehicles With: Lane Centering.....	319
See: Opening and Closing the Hood - RHD.....	406	Adjusting Intelligent Speed Limiter Tolerance Settings.....	320
How Does eCall Work.....	60	Principle of Operation.....	319
How Does the 180 Degree Camera Work.....	266	Switching From Intelligent Speed Limiter to Speed Limiter.....	346
How Does the Rear Occupant Alert System Work.....	186	Switching to Normal Speed Limiter.....	321
Hybrid Vehicle Operation.....	204	Using Intelligent Speed Limiter.....	319
<b>I</b>		Intelligent Speed Limiter - Vehicles Without: Lane Centering.....	317
Ignition Switch.....	192	Adjusting Intelligent Speed Limiter Tolerance Settings.....	318
Starting the Engine.....	193	Principle of Operation.....	317
Switching the Ignition Off.....	192	Switching From Intelligent Speed Limiter to Speed Limiter.....	344
Switching the Ignition On.....	192	Switching to Normal Speed Limiter.....	318
Switching the Ignition to Accessory Mode.....	192	Using Intelligent Speed Limiter.....	317
Information Displays.....	145	Interior Lamps - Vehicles With: Map Reading Lamps.....	124
General Information.....	145	Interior Lamp Function.....	124
Installing Child Restraints - 4-Door.....	35	Switching All of the Interior Lamps On and Off.....	124
Attaching a Child Restraint With a Support Leg.....	38	Switching the Front Interior Lamps On and Off.....	124
Attaching a Child Restraint With Top Tethers.....	38	Switching the Rear Interior Lamps On and Off.....	124
Booster Seats.....	36	Interior Lamps - Vehicles Without: Map Reading Lamps.....	123
Child Restraints for Different Mass Groups.....	36	Interior Lamp Function.....	123
ISOFIX Anchor Points.....	37	Switching All of the Interior Lamps On and Off.....	123
Top Tether Anchor Points.....	38	Switching the Rear Interior Lamps On and Off.....	123
Installing Child Restraints - 5-Door/ Wagon.....	39	Interior Mirror.....	128
Attaching a Child Restraint With a Support Leg.....	43	Auto-Dimming Interior Mirror.....	128
Attaching a Child Restraint With Top Tethers.....	42	Introduction.....	15
Booster Seats.....	40		

# Index

## J

Jump Starting the Vehicle.....	390
Connecting the Jumper Cables.....	390
Starting the Engine.....	391

## K

Keyless Entry.....	83
Keyless Entry Settings.....	83
Keyless Entry – Troubleshooting.....	85
Locking and Unlocking the Doors Using Keyless Entry.....	84
Locking and Unlocking the Liftgate Using Keyless Entry.....	85
Keyless Entry Limitations.....	83
Keyless Entry Settings.....	83
Reprogramming the Unlocking Function.....	83
Switching Keyless Entry On and Off.....	83
Keyless Entry – Troubleshooting.....	85
Keyless Entry – Frequently Asked Questions.....	85
Keys and Remote Controls.....	63
Keys and Remote Controls – Troubleshooting.....	66
Keys and Remote Controls – Troubleshooting.....	66
Keys and Remote Controls – Information Messages.....	66

## L

Lane Keeping System.....	323
Lane Keeping System Display.....	326
Lane Keeping System Indicators.....	326
Lane Keeping System Messages.....	327
Lane Keeping System Settings.....	324
Lane Keeping System Warning Lamp.....	326
Switching Lane Keeping System On and Off.....	324
Launch Control Indicators.....	439
Launch Control.....	439
Launch Control Limitations.....	439
Launch Control Precautions.....	439
Liftgate.....	86

Lighting Control.....	106
Exterior Lamps On Audible Warning.....	107
Flashing High Beam Headlamps.....	107
Headlamps Information Messages.....	108
High Beam Headlamp Indicator.....	107
Lamps On Indicator.....	107
Lighting Control Positions.....	106
Low Beam Headlamp Warning Lamp.....	107
Switching All of the Parking Lamps On.....	106
Switching High Beam Headlamps On and Off.....	107
Switching the Left-Hand Side or the Right-Hand Side Parking Lamps On.....	106
Lighting.....	106
General Information.....	106
Load Carriers	
See: Roof Racks and Load Carriers – 4-Door, Vehicles With: Panoramic Roof Opening Panel.....	374
See: Roof Racks and Load Carriers – 5-Door, Vehicles With: Panoramic Roof Opening Panel.....	374
See: Roof Racks and Load Carriers – Vehicles Without: Panoramic Roof Opening Panel.....	376
See: Roof Racks and Load Carriers – Wagon, Vehicles With: Panoramic Roof Opening Panel.....	375
Load Carrying.....	370
General Information.....	370
Local Hazard Information.....	369
Local Hazard Information Precautions.....	369
Locating the Rear View Camera.....	263
Locating the Wireless Accessory Charger.....	189
Locating Your Vehicle.....	64
Locking and Unlocking the Doors Using Keyless Entry.....	84
Double Locking the Doors.....	85
Locking the Doors.....	84
Unlocking the Doors.....	84
Locking and Unlocking the Liftgate Using Keyless Entry.....	85
Locking the Liftgate.....	85
Unlocking the Liftgate.....	85

# Index

Locking the Rear Window Controls.....	127
Locking the Steering Wheel - Vehicles With: Keyless Entry/Push Button Start.....	98
Unlocking the Steering Wheel.....	98
Locking the Steering Wheel - Vehicles Without: Push Button Start.....	97
Unlocking the Steering Wheel.....	97
Luggage Anchor Points.....	370
Luggage Compartment Hook.....	377
Luggage Compartment.....	377
Luggage Covers - 5-Door.....	374
Removing the Cover.....	374
Luggage Covers - Wagon.....	373
Closing the Luggage Cover.....	373
Opening the Luggage Cover.....	373
Removing the Luggage Cover.....	373
Stowing the Luggage Cover.....	374
Lug Nuts	
See: Changing a Road Wheel.....	451
Lug Nuts.....	462
Locking Lug Nuts.....	462
Lug Nut Torque.....	462
<b>M</b>	
Maintenance.....	404
General Information.....	404
Manual Climate Control.....	162
Directing Air to the Footwell Air Vents.....	162
Directing Air to the Instrument Panel Air Vents.....	162
Directing Air to the Windshield Air Vents.....	162
Setting the Blower Motor Speed.....	162
Setting the Temperature.....	163
Switching Maximum Cooling On and Off.....	162
Switching Maximum Defrost On and Off.....	162
Switching the Air Conditioning On and Off.....	162
Switching the Climate Control On and Off.....	162
Switching the Recirculated Air On and Off.....	162
Manual Liftgate.....	86
Closing the Liftgate.....	86
Liftgate Ajar Information Messages.....	86
Liftgate Ajar Warning Lamp.....	86
Opening the Liftgate Using the Exterior Release Button.....	86
Opening the Liftgate Using the Remote Control.....	86
Manually Making an Emergency Call.....	60
Manually Shifting Gears - Vehicles With: Paddle Shifters.....	238
Shifting Using the Paddle Shifters.....	238
Manual Seats - Vehicles With: 2-Way Manual Seat.....	178
Adjusting the Seat Backrest.....	179
Moving the Seat Backward and Forward.....	178
Manual Seats - Vehicles With: 4-Way Manual Seat.....	179
Adjusting the Lumbar Support.....	180
Adjusting the Seat Backrest.....	180
Adjusting the Seat Height.....	180
Moving the Seat Backward and Forward.....	179
Manual Seats - Vehicles With: 6-Way Manual Seat.....	180
Adjusting the Lumbar Support.....	182
Adjusting the Seat Backrest.....	181
Adjusting the Seat Cushion.....	181
Adjusting the Seat Height.....	181
Moving the Seat Backward and Forward.....	180
Manual Transmission.....	235
Manual Transmission - Troubleshooting.....	236
Manual Transmission Precautions.....	235
Manual Transmission Shift Indicators.....	235
Manual Transmission - Troubleshooting.....	236
Manual Transmission - Frequently Asked Questions.....	236

# Index

Message Center	
See: Information Displays - Vehicles With: 12.3 Inch Instrument Cluster Display Screen.....	153
See: Information Displays - Vehicles With: 4.2 Inch Instrument Cluster Display Screen.....	145
Mislock.....	80
How Does Mislock Work.....	80
Mislock Limitations.....	80
Switching Mislock On and Off.....	81
What Is Mislock.....	80
Mobile Communications Equipment.....	17
Mobile Device Data - Vehicles With:	
SYNC 3.....	21
Moonroof Bounce-Back.....	132
Moonroof.....	131
MyKey Settings.....	68
Configurable MyKey Settings.....	68
Non-Configurable MyKey Settings.....	68
MyKey – Troubleshooting.....	72
MyKey – Frequently Asked Questions.....	74
MyKey – Information Messages.....	72
MyKey™.....	68
MyKey Settings.....	68
MyKey – Troubleshooting.....	72
<b>N</b>	
Navigation.....	533
Changing the Format of the Map.....	534
Live Traffic.....	536
Navigation Map Updates.....	536
Route Guidance.....	534
Setting a Destination.....	533
Zoom.....	534
<b>O</b>	
Oil Change Indicator Reset - Vehicles With: 12.3 Inch Instrument Cluster Display Screen.....	423
Oil Change Indicator Reset - Vehicles With: 4.2 Inch Instrument Cluster Display Screen.....	422
Oil Check	
See: Engine Oil Check.....	421
Opening and Closing the Flip Key.....	63
Opening and Closing the Hood - LHD.....	404
Closing the Hood.....	405
Information Messages.....	405
Opening the Hood.....	404
Warning Lamps and Indicators.....	405
Opening and Closing the Hood - RHD.....	406
Closing the Hood.....	407
Information Messages.....	408
Opening the Hood.....	406
Opening the Hood if the Passenger Door cannot be Opened.....	406
Warning Lamps and Indicators.....	407
Opening and Closing the Moonroof.....	131
Closing the Moonroof.....	131
Opening the Moonroof.....	131
Opening and Closing the Sun Shade.....	131
Closing the Sun Shades.....	131
Opening the Sun Shades.....	131
Opening and Closing the Windows.....	125
One-Touch Close.....	125
One-Touch Open.....	125
Operating the Doors From Inside Your Vehicle.....	78
Unlocking and Locking the Doors Using the Central Locking.....	78
Operating the Doors From Outside Your Vehicle.....	76
Double Locking the Doors Using the Key Blade.....	77
Double Locking the Doors Using the Remote Control.....	77
Individually Unlocking and Locking the Doors Using the Key Blade.....	78
Unlocking and Locking the Doors Using the Key Blade.....	76
Unlocking and Locking the Doors Using the Remote Control.....	76
<b>P</b>	
Parking Aid Indicators.....	261
Parking Aid Precautions.....	257
Parking Aids.....	257
Front Parking Aid.....	258
Parking Aids – Troubleshooting.....	261



# Index

Rear Parking Aid.....	258
Side Parking Aid.....	259
Parking Aids – Troubleshooting.....	261
Parking Aids – Information Messages.....	261
Passenger Airbag.....	53
Airbag Secondary Warning Audible Warning.....	53
Airbag Warning Lamp.....	53
Passive Anti-Theft System.....	92
Arming the Passive Anti-Theft System.....	92
Disarming the Passive Anti-Theft System.....	92
What Is the Passive Anti-Theft System.....	92
Passive Key Backup Position.....	67
Personalized Settings.....	148
Chimes.....	149
Language.....	148
Main Screen.....	154
Measure Unit.....	149
Speedometer.....	154
Tachometer.....	154
Temperature Unit.....	149
Tire Pressure Unit.....	149
Phone.....	531
Android Auto.....	533
Apple CarPlay.....	532
Pairing Your Cell Phone for the First Time.....	531
Text Messaging.....	532
Using Your Cell Phone.....	531
Playing Media From a USB Device - Vehicles With: SYNC 2.5.....	512
Selecting the USB Device.....	512
Supported File Formats.....	512
Playing Media From a USB Device - Vehicles Without: SYNC.....	511
Selecting the USB Device.....	511
Supported Audio File Formats.....	511
Post-Crash Alert System.....	394
How Does the Post-Crash Alert System Work.....	394
Post-Crash Alert System Limitations.....	394
Switching the Post-Crash Alert System Off.....	394
What Is the Post-Crash Alert System.....	394
Post Impact Braking.....	394
How Does Post Impact Braking Work.....	394
Overriding Post Impact Braking.....	394
Post Impact Braking Indicators.....	394
Post Impact Braking Limitations.....	394
Power Liftgate.....	87
Closing the Liftgate.....	88
Liftgate Ajar Information Messages.....	90
Liftgate Ajar Warning Lamp.....	89
Obstacle Detection.....	89
Opening the Liftgate.....	87
Setting the Liftgate Open Height.....	88
Stopping the Liftgate Movement.....	89
Switching the Power Liftgate On or Off.....	89
Power Seats.....	182
Power Lumbar.....	183
Pre-Collision Assist.....	338
Distance Alert.....	339
Distance Indication.....	339
Evasive Steering Assist.....	342
Pre-Collision Assist Information Messages.....	341
Pre-Collision Assist System Sensors.....	340
Pre-Collision Assist Warning Lamp.....	341
Switching Active Braking On and Off.....	339
Programming a MyKey - Vehicles With: 12.3 Inch Instrument Cluster Display Screen.....	71
Programming a MyKey - Vehicles With: 4.2 Inch Instrument Cluster Display Screen.....	71
Protecting the Environment.....	23
Puncture See: Changing a Road Wheel.....	451
Push Button Ignition Switch.....	193
Starting the Engine.....	193
Switching the Ignition Off.....	193
Switching the Ignition to Accessory Mode.....	193
<b>R</b>	
REACH.....	16

# Index

Rear Fog Lamps.....	117
Rear Fog Lamp Indicator.....	117
Switching the Rear Fog Lamps On or Off.....	117
Rear Lamp Removal	
See: Removing a Rear Lamp - 4-Door.....	433
See: Removing a Rear Lamp - 5-Door/Wagon.....	432
Rear Loadspace Hatches.....	370
Rear Occupant Alert System Audible Warnings.....	187
Rear Occupant Alert System Indicators.....	187
Rear Occupant Alert System Limitations.....	186
Rear Occupant Alert System Precautions.....	186
Rear Occupant Alert System.....	186
Rear Parking Aid.....	258
Locating the Rear Parking Aid Sensors.....	258
Rear Parking Aid Audible Warnings.....	258
Rear Parking Aid Limitations.....	258
What is the Rear Parking Aid.....	258
Rear Seats - 4-Door/5-Door.....	184
Folding the Seat Backrests.....	184
Unfolding the Seat Backrests.....	185
Rear Seats - Wagon.....	183
Folding the Seat Backrests.....	183
Unfolding the Seat Backrests.....	184
Rear Under Floor Storage - Wagon.....	371
Increasing the Loadspace Height.....	372
Rear View Camera Guide Lines.....	263
Rear View Camera Limitations.....	263
Rear View Camera Precautions.....	263
Rear View Camera.....	263
Rear View Camera Settings.....	264
Rear View Camera Settings.....	264
Switching Rear View Camera Delay On and Off.....	265
Switching Rear View Camera Object Distance Indicator On and Off.....	265
Zooming the Rear View Camera In and Out.....	264
Rear Window Wiper and Washers - Vehicles With: 12.3 Inch Instrument Cluster Display Screen.....	104
Rear Window Washer.....	105
Rear Window Wiper.....	104
Rear Window Wiper and Washers - Vehicles With: 4.2 Inch Instrument Cluster Display Screen.....	103
Rear Window Washer.....	104
Rear Window Wiper.....	103
Rear Wiper Blades	
See: Changing the Rear Wiper Blades.....	430
Refueling.....	219
Refueling System Overview.....	219
Refueling System Warning.....	221
Refueling Your Vehicle.....	219
Remote Control Limitations.....	63
Remotely Starting and Stopping the Vehicle.....	158
Remote Start Limitations.....	158
Remote Start.....	158
Remote Start Settings - Vehicles With: 12.3 Inch Instrument Cluster Display Screen, Vehicles Without: Heated Steering Wheel.....	159
Climate Control Settings.....	159
Heated Seat Settings.....	160
Setting the Remote Start Duration.....	160
Remote Start Settings - Vehicles With: 12.3 Inch Instrument Cluster Display Screen/Heated Steering Wheel.....	161
Climate Control Settings.....	161
Heated Seat and Steering Wheel Settings.....	161
Setting the Remote Start Duration.....	161
Remote Start Settings - Vehicles With: 4.2 Inch Instrument Cluster Display Screen, Vehicles Without: Heated Steering Wheel.....	159
Climate Control Settings.....	159
Heated Seat Settings.....	159
Setting the Remote Start Duration.....	159
Remote Start Settings - Vehicles With: 4.2 Inch Instrument Cluster Display Screen/Heated Steering Wheel.....	160
Climate Control Settings.....	160
Heated Seat and Steering Wheel Settings.....	160
Setting the Remote Start Duration.....	160
Removing a Headlamp.....	431

# Index

Removing a Rear Lamp - 4-Door.....	433
Brake Lamp, Rear Lamp and Direction Indicator.....	433
Reversing Lamp and Rear Lamp.....	433
Removing a Rear Lamp - 5-Door/ Wagon.....	432
Brake Lamp, Rear Lamp and Direction Indicator.....	432
Reversing Lamp and Rear Lamp.....	432
Removing the Key Blade.....	63
Repairing Minor Paint Damage.....	443
Replacement Parts	
Recommendation.....	17
Collision Repairs.....	17
Scheduled Maintenance and Mechanical Repairs.....	17
Warranty on Replacement Parts.....	17
Replacing a Lost Key or Remote Control.....	66
Reprogramming the Unlocking Function - Vehicles With: 12.3 Inch Instrument Cluster Display Screen.....	79
Reprogramming the Unlocking Function - Vehicles With: 4.2 Inch Instrument Cluster Display Screen.....	78
Resetting Tire Pressure Monitoring System - Vehicles With: 12.3 Inch Instrument Cluster Display Screen.....	464
Resetting Tire Pressure Monitoring System - Vehicles With: 4.2 Inch Instrument Cluster Display Screen.....	464
Restarting the Engine.....	205
Restarting the Engine in Gear.....	212
Restarting the Engine in Neutral.....	212
Roadside Emergencies.....	390
Roof Racks and Load Carriers - 4-Door, Vehicles With: Panoramic Roof Opening Panel.....	374
Roof Racks and Load Carriers - 5-Door, Vehicles With: Panoramic Roof Opening Panel.....	374
Towbar Carriers.....	375
Roof Racks and Load Carriers - Vehicles Without: Panoramic Roof Opening Panel.....	376
Tow Bar Carriers.....	376
Roof Racks and Load Carriers - Wagon, Vehicles With: Panoramic Roof Opening Panel.....	375
Tow Bar Carriers.....	376
Running-In	
See: Breaking-In.....	388
Running Out of Fuel.....	217
Adding Fuel From a Portable Fuel Container.....	218
Filling a Portable Fuel Container.....	218
<b>S</b>	
Safety Precautions.....	215
Seatbelt Height Adjustment.....	48
Seatbelt Reminder - Vehicles With: 12.3 Inch Instrument Cluster Display Screen.....	50
Fasten Seatbelt Audible Warning.....	50
Fasten Seatbelt Warning Lamp.....	50
Seatbelt Status.....	50
Seatbelt Reminder - Vehicles With: 4.2 Inch Instrument Cluster Display Screen.....	49
Fasten Seatbelt Audible Warning.....	49
Fasten Seatbelt Warning Lamp.....	49
Seatbelt Status.....	49
Seatbelts.....	48
Seats.....	177
Security.....	92
Anti-Theft Alarm System.....	92
Anti-Theft Alarm System Settings.....	93
Passive Anti-Theft System.....	92
Security - Troubleshooting.....	94
Security - Troubleshooting.....	94
Security - Frequently Asked Questions.....	95
Security - Information Messages.....	94
Selecting a Drive Mode - Excluding: ST.....	365
Selecting a Drive Mode - ST.....	365
Selective Catalytic Reduction Fluid Consumption.....	231
Selective Catalytic Reduction System Guidelines.....	228
Selective Catalytic Reduction System Precautions.....	228

# Index

Selective Catalytic Reduction System	
Requirements.....	228
Selective Catalytic Reduction System.....	228
Filling the Selective Catalytic Reduction System Tank.....	229
Selective Catalytic Reduction System – Troubleshooting.....	232
Selective Catalytic Reduction System – Troubleshooting.....	232
Selective Catalytic Reduction System – Frequently Asked Questions.....	234
Selective Catalytic Reduction System – Information Messages.....	232
Selective Catalytic Reduction System – Warning Lamps.....	232
Service Data.....	20
Settings Data.....	21
Comfort and Convenience Data.....	21
Entertainment Data.....	21
Settings.....	538
Ambient Lighting.....	538
Android Auto.....	538
Apple CarPlay.....	538
Audio.....	538
Automatic Updates.....	538
Bluetooth.....	538
Clock.....	538
Display.....	538
Emergency Assistance.....	538
FordPass.....	538
General.....	538
Mobile Apps.....	538
Navigation.....	538
Phone.....	538
Seats.....	538
Sound.....	538
Valet Mode.....	539
Vehicle.....	539
Voice Control.....	539
Wi-Fi.....	539
Shifting Into Reverse.....	235
Side Airbags.....	55
Airbag Secondary Warning Audible Warning.....	56
Airbag Warning Lamp.....	56
Side Curtain Airbags.....	56
Airbag Secondary Warning Audible Warning.....	56
Airbag Warning Lamp.....	56
Side Parking Aid.....	259
Locating the Side Parking Aid Sensors.....	260
Side Parking Aid Audible Warnings.....	260
Side Parking Aid Limitations.....	259
What is the Side Parking Aid.....	259
Sitting in the Correct Position.....	177
Snow Chains	
See: Using Snow Chains - Active.....	450
See: Using Snow Chains - Excluding: Active/ST.....	449
See: Using Snow Chains - ST.....	451
Spare Wheel	
See: Changing a Road Wheel.....	451
Speed Control	
See: Cruise Control.....	272
Speed Sign Recognition.....	334
Principle of Operation.....	334
Speed Sign Recognition System Display.....	335
Speed Sign Recognition System Messages.....	335
Using Speed Sign Recognition.....	334
Stability Control.....	255
Principle of Operation.....	255
Starter Switch	
See: Ignition Switch.....	192
Starting and Stopping the Engine – Precautions.....	192
Starting and Stopping the Engine.....	192
Automatic Engine Stop - Vehicles With: Push Button Start.....	199
Starting and Stopping the Engine – Troubleshooting.....	200
Starting the Engine.....	193
Stopping the Engine.....	196
Starting and Stopping the Engine – Troubleshooting.....	200
Starting and Stopping the Engine – Frequently Asked Questions.....	201
Starting and Stopping the Engine – Information Messages.....	200
Starting and Stopping the Engine – Warning Lamps.....	200

# Index

Starting the Engine.....	193
Restarting the Engine After Stopping it.....	196
Starting a Diesel Engine.....	194
Starting a Gasoline Engine.....	193
Stay in Neutral Mode - 8-Speed Automatic Transmission.....	239
Entering Stay in Neutral Mode.....	239
Exiting Stay in Neutral Mode.....	239
Stay in Neutral Mode Precautions.....	239
What Is Stay in Neutral Mode.....	239
Steering.....	337
Steering Information Messages.....	337
Steering Wheel - Excluding: ST.....	24
Steering Wheel.....	97
Steering Wheel - ST.....	24
Stopping the Engine.....	205
Stopping the Engine in Gear.....	211
Stopping the Engine in Neutral.....	212
Stopping the Engine When Your Vehicle is Moving.....	197
Stopping the Engine When Your Vehicle is Stationary.....	196
Storage Compartments.....	191
Streaming Bluetooth Audio - Vehicles With: SYNC 2.5.....	511
Streaming Bluetooth Audio - Vehicles Without: SYNC.....	510
Selecting a Source.....	510
Sunroof See: Moonroof.....	131
Supplementary Restraints System.....	52
Principle of Operation.....	52
Switching Active Park Assist On and Off.....	267
Cancelling Active Park Assist.....	267
Switching Auto-Start-Stop On and Off.....	205
Switching Efficient Drive Mode On and Off - Vehicles With: 12.3 Inch Instrument Cluster Display Screen.....	367
Switching Efficient Drive Mode On and Off - Vehicles With: 4.2 Inch Instrument Cluster Display Screen.....	367
Switching Launch Control On and Off.....	439
Switching Parking Aid On and Off.....	257
Switching Rear Occupant Alert System On and Off.....	186
Semiannual Reminder.....	186
Switching the 180 Degree Camera On and Off.....	266
Switching the Passenger Airbag On and Off - Vehicles With: 12.3 Inch Instrument Cluster Display Screen.....	54
Switching the Passenger Airbag Off.....	54
Switching the Passenger Airbag On.....	55
Switching the Passenger Airbag On and Off - Vehicles With: 4.2 Inch Instrument Cluster Display Screen.....	53
Switching the Passenger Airbag Off.....	53
Switching the Passenger Airbag On.....	54
Symbols Glossary.....	15
SYNC™ 3.....	518
General Information.....	518
SYNC™ 3 Troubleshooting.....	540
Additional Information and Assistance.....	549
Apps.....	546
Navigation.....	545
Phone.....	544
Resetting the System.....	549
USB and Bluetooth Audio.....	541
Voice Recognition.....	540
Wi-Fi Connectivity.....	548

## T

Technical Specifications See: Capacities and Specifications.....	467
Tire Care.....	448
Tire Inflation When Punctured See: Tire Sealant and Inflator Kit.....	444
Tire Pressure Monitoring System Limitations.....	463
Tire Pressure Monitoring System Precautions.....	463
Tire Pressure Monitoring System.....	463
Tire Pressure Monitoring System - Troubleshooting.....	465
Tire Pressure Monitoring System - Troubleshooting.....	465
Tire Pressure Monitoring System - Information Messages.....	466

# Index

Tire Pressure Monitoring System – Warning Lamps.....	465
Tire Pressures - Active.....	459
Temporary Spare Wheel.....	460
Tire Pressures - Excluding: Active/ ST.....	457
Temporary Spare Wheel.....	458
Tire Pressures - ST.....	460
Temporary Spare Wheel.....	462
Tire Repair Kit See: Tire Sealant and Inflator Kit.....	444
Tire Sealant and Inflator Kit.....	444
After Using the Tire Sealant and Inflator Kit.....	448
Using the Tire Sealant and Inflator Kit.....	445
Tires See: Wheels and Tires.....	444
Tow Ball - Vehicles With: Detachable Tow Ball.....	379
Attaching the Tow Ball Arm.....	381
Detaching the Tow Ball Arm.....	380
Tow Ball Arm Guidelines.....	382
Tow Ball - Vehicles With: Retractable Tow Ball.....	383
Deploying the Tow Ball Arm.....	383
Retracting the Tow Ball Arm.....	384
Tow Ball Arm Guidelines.....	385
Towbar Dimensions - 5-Door.....	472
Maximum Permissible Trailer Vertical Weight.....	473
Towbar Dimensions - Wagon.....	474
Maximum Permissible Trailer Vertical Weight.....	475
Towing a Trailer - 4-Door.....	378
Towing a Trailer - 5-Door/Wagon.....	378
Towing Points.....	392
Attaching the Towing Eye.....	392
Front Towing Point.....	392
Rear Towing Point.....	392
Towing Eye Location.....	393
Towing the Vehicle on Four Wheels - 6-Speed Automatic Transmission.....	385
Emergency Towing.....	386
Towing the Vehicle on Four Wheels - 7-Speed Automatic Transmission/ 8-Speed Automatic Transmission.....	387
Towing the Vehicle on Four Wheels - Manual Transmission.....	387
Towing.....	378
Track Use Precautions.....	438
Track Use.....	438
Traction Control.....	254
Principle of Operation.....	254
Traffic Sign Recognition.....	332
Principle of Operation.....	332
Setting the Speed Warning.....	333
Switching Speed Warning On and Off.....	333
Traffic Sign Recognition System Display.....	333
Traffic Sign Recognition System Messages.....	334
Trailer Sway Control.....	379
Trip Computer.....	147
Average Fuel.....	148
Average Speed.....	148
Distance to Empty.....	148
Instantaneous Fuel.....	148
Personalization.....	147
Resetting the Trip Computer.....	147
Trip Odometer.....	148
Trip Timer.....	148
Trip Summary.....	367
How Does Trip Summary Work.....	367
Viewing the Trip Summary.....	367

## U

Under Hood Overview - 1.0L EcoBoost™, LHD.....	408
Under Hood Overview - 1.0L EcoBoost™, RHD.....	409
Under Hood Overview - 1.5L EcoBlue, LHD.....	412
Under Hood Overview - 1.5L EcoBlue, RHD.....	413
Under Hood Overview - 1.5L EcoBoost™, LHD.....	414
Under Hood Overview - 1.5L EcoBoost™, RHD.....	415

# Index

Under Hood Overview - 1.5L TiVCT, LHD.....	410
Under Hood Overview - 1.5L TiVCT, RHD.....	411
Under Hood Overview - 2.0L EcoBlue, LHD.....	416
Under Hood Overview - 2.0L EcoBlue, RHD.....	417
Under Hood Overview - 2.3L EcoBoost™, LHD.....	418
Under Hood Overview - 2.3L EcoBoost™, RHD.....	419
Unique Driving Characteristics.....	204
USB Port.....	512
Using Adaptive Cruise Control - Vehicles With: 12.3 Inch Instrument Cluster	
Display Screen/Adaptive Cruise Control.....	294
Adaptive Cruise Control Indicator.....	301
Adaptive Cruise Control Information Messages.....	301
Adaptive Cruise Control System Sensors.....	299
Adaptive Cruise Control With Speed Sign Recognition.....	302
Adaptive Cruise Control With Speed Sign Recognition Information Messages.....	304
Automatic Cancellation.....	297
Canceling the Set Speed.....	297
Changing the Set Speed.....	297
Detection Issues.....	298
Following a Vehicle.....	295
Hilly Condition Usage.....	297
Overriding the System.....	297
Resuming the Set Speed.....	297
Setting the Adaptive Cruise Speed.....	295
Setting the Gap Distance.....	296
Switching Adaptive Cruise Control Off.....	298
Switching Adaptive Cruise Control On.....	295
Switching Between the Cruise Control Modes.....	302
Switching to Normal Cruise Control.....	300
System Not Available.....	299
Using Adaptive Cruise Control - Vehicles With: 12.3 Inch Instrument Cluster	
Display Screen/Adaptive Cruise Control.....	304
Adaptive Cruise Control Indicator.....	311
Adaptive Cruise Control Information Messages.....	311
Adaptive Cruise Control System Sensors.....	309
Adaptive Cruise Control With Lane Centering.....	312
Adaptive Cruise Control With Speed Sign Recognition.....	314
Adaptive Cruise Control With Speed Sign Recognition Information Messages.....	316
Automatic Cancellation.....	308
Canceling the Set Speed.....	307
Changing the Set Speed.....	307
Detection Issues.....	308
Following a Vehicle.....	305
Following a Vehicle to a Complete Stop.....	306
Hilly Condition Usage.....	308
Lane Centering Information Messages.....	314
Overriding the System.....	307
Parking Brake Application.....	308
Resuming the Set Speed.....	307
Setting the Adaptive Cruise Speed.....	305
Setting the Adaptive Cruise Speed When Your Vehicle is Stationary.....	305
Setting the Gap Distance.....	306
Switching Adaptive Cruise Control Off.....	308
Switching Adaptive Cruise Control On.....	305
Switching Between the Cruise Control Modes.....	314
Switching to Normal Cruise Control.....	310
System Not Available.....	309
Using Adaptive Cruise Control - Vehicles With: 4.2 Inch Instrument Cluster	
Display Screen/Adaptive Cruise Control.....	273
Adaptive Cruise Control Indicator.....	279
Adaptive Cruise Control Information Messages.....	279

# Index

Adaptive Cruise Control System	
Sensors.....	277
Adaptive Cruise Control With Speed Sign Recognition.....	280
Adaptive Cruise Control With Speed Sign Recognition Information	
Messages.....	281
Automatic Cancellation.....	276
Canceling the Set Speed.....	276
Changing the Set Speed.....	275
Detection Issues.....	276
Following a Vehicle.....	274
Hilly Condition Usage.....	276
Overriding the System.....	275
Resuming the Set Speed.....	276
Setting the Adaptive Cruise Speed.....	274
Setting the Gap Distance.....	275
Switching Adaptive Cruise Control	
Off.....	276
Switching Adaptive Cruise Control	
On.....	273
Switching Between the Cruise Control	
Modes.....	280
Switching to Normal Cruise Control.....	278
System Not Available.....	277
Using Adaptive Cruise Control - Vehicles With: 4.2 Inch Instrument Cluster Display Screen/Adaptive Cruise Control With Lane Centering.....	282
Adaptive Cruise Control Indicator.....	289
Adaptive Cruise Control Information	
Messages.....	289
Adaptive Cruise Control System	
Sensors.....	287
Adaptive Cruise Control With Lane Centering.....	289
Adaptive Cruise Control With Speed Sign Recognition.....	292
Adaptive Cruise Control With Speed Sign Recognition Information	
Messages.....	294
Automatic Cancellation.....	285
Canceling the Set Speed.....	285
Changing the Set Speed.....	285
Detection Issues.....	286
Following a Vehicle.....	283
Following a Vehicle to a Complete Stop.....	284
Hilly Condition Usage.....	285
Lane Centering Information	
Messages.....	292
Overriding the System.....	285
Parking Brake Application.....	285
Resuming the Set Speed.....	285
Setting the Adaptive Cruise Speed.....	283
Setting the Adaptive Cruise Speed When Your Vehicle is Stationary.....	283
Setting the Gap Distance.....	284
Switching Adaptive Cruise Control	
Off.....	286
Switching Adaptive Cruise Control	
On.....	282
Switching Between the Cruise Control	
Modes.....	292
Switching to Normal Cruise Control.....	288
System Not Available.....	287
Using Cruise Control.....	272
Canceling the Set Speed.....	272
Changing the Set Speed.....	272
Cruise Control Indicator.....	273
Resuming the Set Speed.....	272
Setting the Cruise Speed.....	272
Switching Cruise Control Off.....	272
Switching Cruise Control On.....	272
Using Launch Control.....	439
Using MyKey With Remote Start	
Systems.....	72
Using Snow Chains - Active.....	450
Vehicles with Stability Control.....	450
Using Snow Chains - Excluding: Active/ST.....	449
Vehicles with Stability Control.....	450
Using Snow Chains - ST.....	451
Vehicles with Stability Control.....	451
Using Stability Control - Excluding:	
ST.....	255
Stability Control Indicator.....	255
Using Stability Control - ST.....	255
Reducing Stability Control.....	255
Stability Control and Traction Control	
Indicator.....	256
Stability Control and Traction Control Off	
Warning Lamp.....	256
Switching the System Off.....	256
Using Summer Tires.....	449



# Index

Using Traction Control.....	254	Washer Fluid Check.....	430
Switching Traction Control On or Off.....	254	Washers	
Traction Control Indicator.....	254	See: Wipers and Washers.....	99
Traction Control Off Warning Lamp.....	254	Waxing Your Vehicle.....	443
Using Voice Recognition.....	515	What Is a Connected Vehicle.....	497
Apps.....	525	What Is Active Park Assist.....	267
Automatic Blower Motor Speed		What Is Auto-Start-Stop.....	205
Reduction.....	526	What Is Drive Mode Control.....	365
Entertainment.....	521	What Is eCall.....	60
General.....	520	What Is Efficient Drive Mode.....	367
Navigation.....	524	What Is Launch Control.....	439
Phone.....	523	What Is Local Hazard Information.....	369
Phone Voice Service.....	515	What Is MyKey.....	68
Voice Settings.....	525	What Is Remote Start.....	158
Using Winter Tires.....	449	What Is the 180 Degree Camera.....	266
<b>V</b>		What Is the Rear Occupant Alert	
Vehicle Care.....	440	System.....	186
Cleaning the Exterior.....	440	What Is the Rear View Camera.....	263
Cleaning the Interior.....	441	What Is the Selective Catalytic	
Vehicle Dimensions - 4-Door.....	471	Reduction System.....	228
Vehicle Dimensions - 5-Door, Excluding:		What Is the Tire Pressure Monitoring	
Active.....	469	System.....	463
Vehicle Dimensions - 5-Door/		Wheel Nuts	
Active.....	468	See: Changing a Road Wheel.....	451
Vehicle Dimensions - Excluding:		Wheels and Tires.....	444
Active.....	470	General Information.....	444
Vehicle Dimensions.....	467	Window Bounce-Back.....	126
Vehicle Identification Number.....	476	Overriding Window Bounce-Back.....	126
Vehicle Identification Plate.....	475	Resetting Window Bounce-Back.....	127
Vehicle Wi-Fi Hotspot.....	501	What Is Window Bounce-Back.....	126
Ventilation		Windows.....	125
See: Climate Control.....	162	Global Opening and Closing.....	125
Venting the Moonroof.....	132	Window Bounce-Back.....	126
Viewing the Tire Pressures - Vehicles		Windshield Washers - Vehicles With: 12.3	
With: 12.3 Inch Instrument Cluster		Inch Instrument Cluster Display	
Display Screen.....	464	Screen.....	103
Viewing the Tire Pressures - Vehicles		Switching the Courtesy Wipe On and	
With: 4.2 Inch Instrument Cluster		Off.....	103
Display Screen.....	463	Windshield Washers - Vehicles With: 4.2	
VIN		Inch Instrument Cluster Display	
See: Vehicle Identification Number.....	476	Screen.....	102
Visual Search.....	24	Settings.....	102
<b>W</b>		Windshield Wipers.....	99
Warning Triangle.....	390	Intermittent Wipe.....	99
		Winter Tires	
		See: Using Winter Tires.....	449
		Wiper Blades	
		See: Checking the Wiper Blades.....	430

# Index

---

Wipers and Washers.....	99
Wireless Accessory Charger Indicators.....	189
Wireless Accessory Charger – Troubleshooting.....	190
Wireless Accessory Charger – Information Messages.....	190
Wireless Accessory Charger.....	189
Wireless Accessory Charger – Troubleshooting.....	190
Wrong Way Alert.....	335
Switching Wrong Way Alert On and Off.....	359
Switching Wrong Way Alert On or Off.....	336
Wrong Way Alert Information Messages.....	336



