

FORD FIESTA VIGNALE Owner's Manual



The information contained in this publication was correct at the time of going to print. In the interest of continuous development, we reserve the right to change specifications, design or equipment at any time without notice or obligation. No part of this publication may be reproduced, transmitted, stored in a retrieval system or translated into any language in any form by any means without our written permission. Errors and omissions excepted.

© Ford Motor Company 2020

All rights reserved.

Part Number: CG3657en 202012 20201215133259

Table of Contents

Introduction

Acknowledgments	11
About This Manual	11
Symbols Glossary	11
REACH	13
Replacement Parts Recommendation	14
Mobile Communications Equipment	14

Data Privacy

Data Privacy	16
Service Data	17
Event Data	17
Settings Data	18
Connected Vehicle Data - Vehicles With: Modem	18
Mobile Device Data - Vehicles With: SYNC 3	18
Emergency Call System Data	19

Environment

Protecting the Environment	20
----------------------------------	----

Visual Search

Steering Wheel - Excluding: ST	21
Steering Wheel - ST	21

Instrument Panel - LHD	22
Instrument Panel - RHD	24
Center Console - Liquefied Petroleum Gas (LPG), Vehicles Without: Active Park Assist/Front Parking Aid	26
Center Console - Liquefied Petroleum Gas (LPG), Vehicles With: Active Park Assist/ Front Parking Aid/Rear Parking Aid	26
Center Console - Manual Transmission, LHD, Vehicles Without: Active Park Assist/Front Parking Aid/Rear Parking Aid, Excluding: Liquefied Petroleum Gas (LPG)	27
Center Console - Manual Transmission, LHD, Vehicles With: Active Park Assist/ Front Parking Aid/Rear Parking Aid, Excluding: Liquefied Petroleum Gas (LPG)	27
Center Console - Manual Transmission, RHD, Vehicles Without: Active Park Assist/Front Parking Aid/Rear Parking Aid, Excluding: Liquefied Petroleum Gas (LPG)	28
Center Console - Manual Transmission, RHD, Vehicles With: Active Park Assist/ Front Parking Aid/Rear Parking Aid, Excluding: Liquefied Petroleum Gas (LPG)	29

Center Console - 7-Speed Automatic Transmission, LHD, Vehicles Without: Active Park Assist/Front Parking Aid/ Rear Parking Aid, Excluding: Liquefied Petroleum Gas (LPG)	29
Center Console - 7-Speed Automatic Transmission, LHD, Vehicles With: Active Park Assist/Front Parking Aid/Rear Parking Aid, Excluding: Liquefied Petroleum Gas (LPG)	30
Center Console - 7-Speed Automatic Transmission, RHD, Vehicles Without: Active Park Assist/Front Parking Aid/ Rear Parking Aid, Excluding: Liquefied Petroleum Gas (LPG)	31
Center Console - 7-Speed Automatic Transmission, RHD, Vehicles With: Active Park Assist/Front Parking Aid/Rear Parking Aid, Excluding: Liquefied Petroleum Gas (LPG)	31

Child Safety

Installing Child Restraints	33
Child Restraint Positioning	37
Child Safety Locks	42

Seatbelts

Fastening the Seatbelts	43
Seatbelt Reminder	44

Table of Contents

Supplementary Restraints System

Principle of Operation	46
Driver Airbag	46
Passenger Airbag	47
Switching the Passenger Airbag On and Off	47
Side Airbags	48
Side Curtain Airbags	49

Automatic Crash Notification System

Emergency Assistance	50
----------------------------	----

Keys and Remote Controls

General Information on Radio Frequencies	53
Remote Control - Vehicles With: Keyless Entry	53
Remote Control - Vehicles With: Remote Flip Key	56
Replacing a Lost Key or Remote Control	58
Passive Key Backup Position	58

MyKey™

What Is MyKey	59
---------------------	----

MyKey Settings	59
Creating a MyKey - Vehicles Without: Push Button Start	60
Creating a MyKey - Vehicles With: Push Button Start	60
Programming a MyKey	60
Clearing All MyKeys	60
Checking MyKey System Status	61
Using MyKey With Remote Start Systems	61
MyKey – Troubleshooting	61

Doors and Locks

Operating the Doors From Outside Your Vehicle	65
Operating the Doors From Inside Your Vehicle	67
Reprogramming the Unlocking Function	67
Door Lock Switch Inhibitor	68
Autounlock	68
Autolock	68
Mislock	68
Autorelock	69
Door Lock Indicators	69
Doors and Locks Audible Warnings	69
Doors and Locks – Troubleshooting	69

Keyless Entry

Keyless Entry Limitations	71
Keyless Entry Settings	71
Locking and Unlocking the Doors Using Keyless Entry	72
Locking and Unlocking the Liftgate Using Keyless Entry	72
Keyless Entry – Troubleshooting	73

Liftgate

Manual Liftgate	74
-----------------------	----

Security

Passive Anti-Theft System	75
Anti-Theft Alarm - Vehicles With: Integral Battery	75
Anti-Theft Alarm - Vehicles With: Perimeter Alarm	76

Door Edge Protection

Principle of Operation	78
------------------------------	----

Steering Wheel

Adjusting the Steering Wheel	79
Locking the Steering Wheel - Vehicles Without: Push Button Start	79

Table of Contents

Locking the Steering Wheel - Vehicles With: Push Button Start	79
Heated Steering Wheel	80

Wipers

Wiper Precautions	81
Switching Windshield Wipers On and Off	81
Intermittent Wipe	81
Autowipers	82
Switching the Rear Window Wiper On and Off	83
Switching Reverse Wipe On and Off	83
Checking the Wiper Blades	83
Replacing the Front Wiper Blades	84
Replacing the Rear Wiper Blades	84
Wipers – Troubleshooting	84

Washers

Washer Precautions	85
Washing the Windshield	85
Switching the Courtesy Wipe On and Off	85
Washing the Rear Window	85
Locating the Washer Fluid Reservoir	86
Adding Washer Fluid	86
Washer Fluid Reservoir Capacity	86

Washer Fluid Specification	87
----------------------------------	----

Lighting

General Information	88
Lighting Control	88
Autolamps	91
Instrument Lighting Dimmer	91
Headlamp Exit Delay	91
Automatic High Beam Control	92
Front Fog Lamps	94
Rear Fog Lamps	94
Headlamp Leveling	94
Cornering Lamps	95
Direction Indicators	96
Interior Lamps - Vehicles With: Front Interior Lamp	96
Interior Lamps - Vehicles With: Front Interior Lamp With Map Reading Lamps	97

Windows

Opening and Closing the Windows	99
Global Opening and Closing	99
Window Bounce-Back	100
Locking the Rear Window Controls	101

Interior Mirror

Adjusting the Interior Mirror	102
Auto-Dimming Interior Mirror	102

Exterior Mirrors

Adjusting the Exterior Mirrors	103
Folding the Exterior Mirrors - Vehicles With: Manual Fold Exterior Mirrors	103
Folding the Exterior Mirrors - Vehicles With: Power Fold Exterior Mirrors	103

Moonroof

Opening and Closing the Sun Shade	104
Opening and Closing the Moonroof	104
Venting the Moonroof	104
Moonroof Bounce-Back	104

Instrument Cluster

Gauges - Excluding: Mild Hybrid Electric Vehicle (MHEV)	105
Gauges - Mild Hybrid Electric Vehicle (MHEV)	108
Warning Lamps and Indicators	111
Audible Warnings and Indicators	114

Information Displays

General Information	116
---------------------------	-----

Table of Contents

Trip Computer	117
Personalized Settings	119
Information Messages	121

Remote Start - Automatic Transmission

What Is Remote Start	137
Remote Start Limitations	137
Enabling Remote Start	137
Remotely Starting and Stopping the Vehicle	137
Remote Start Settings - Vehicles Without: Heated Steering Wheel	137
Remote Start Settings - Vehicles With: Heated Steering Wheel	138

Climate Control - Vehicles With: Automatic Temperature Control

Switching Climate Control On and Off	139
Switching Recirculated Air On and Off	139
Switching Air Conditioning On and Off	139
Switching Maximum Defrost On and Off	139

Switching Maximum Cooling On and Off	139
Switching the Heated Windshield On and Off	139
Switching the Heated Rear Window On and Off	139
Switching the Heated Mirrors On and Off	140
Setting the Blower Motor Speed	140
Setting the Temperature	140
Climate Control – Troubleshooting	140

Climate Control - Vehicles With: Manual Temperature Control

Switching Climate Control On and Off	142
Switching Recirculated Air On and Off	142
Switching Air Conditioning On and Off	142
Switching Maximum Defrost On and Off	142
Switching Maximum Cooling On and Off	142
Switching the Heated Windshield On and Off	142
Switching the Heated Rear Window On and Off	142

Switching the Heated Mirrors On and Off	143
Setting the Blower Motor Speed	143
Setting the Temperature	143
Climate Control – Troubleshooting	143

Seats

Sitting in the Correct Position	145
Head Restraints	145
Manual Seats - 3-Door	146
Manual Seats - 5-Door	149
Rear Seats	150
Heated Seats	151

Rear Occupant Alert System

What is the Rear Occupant Alert System	152
How Does the Rear Occupant Alert System Work	152
Rear Occupant Alert System Precautions	152
Rear Occupant Alert System Limitations	152
Switching Rear Occupant Alert System On and Off	153
Rear Occupant Alert System Indicators	153

Table of Contents

Rear Occupant Alert System Audible Warnings	153
---	-----

Auxiliary Power Points

Auxiliary Power Points	154
Cigar Lighter	154

Wireless Accessory Charger

Locating the Wireless Accessory Charger	155
Charging a Wireless Device	155
Wireless Accessory Charger Indicators	156

Storage Compartments

Cup Holders	157
Device Holder	157

Starting and Stopping the Engine

Starting and Stopping the Engine – Precautions	158
Ignition Switch	158
Push Button Ignition Switch	159
Starting the Engine	159
Engine Block Heater	162
Stopping the Engine	163

Automatic Engine Stop	165
Starting and Stopping the Engine – Troubleshooting	166

Unique Driving Characteristics

Auto-Start-Stop - Manual Transmission, Excluding: Mild Hybrid Electric Vehicle (MHEV)	171
Auto-Start-Stop - Automatic Transmission	172
Hybrid Vehicle Operation	174

Auto-Start-Stop - Mild Hybrid Electric Vehicle (MHEV), Manual Transmission

What Is Auto-Start-Stop	175
Auto-Start-Stop Precautions	175
Auto-Start-Stop Settings	175
Switching Auto-Start-Stop On and Off	175
Stopping the Engine	175
Restarting the Engine	176
Auto-Start-Stop Indicators	176
Auto-Start-Stop Audible Warning	176
Auto-Start-Stop – Troubleshooting	177

Auto-Start-Stop - Mild Hybrid Electric Vehicle (MHEV), Automatic Transmission

What Is Auto-Start-Stop	179
Auto-Start-Stop Precautions	179
Switching Auto-Start-Stop On and Off	179
Stopping the Engine	179
Restarting the Engine	179
Auto-Start-Stop Indicators	181
Auto-Start-Stop Audible Warning	181
Auto-Start-Stop – Troubleshooting	181

Fuel and Refueling

Safety Precautions	183
Fuel Quality - E85	183
Fuel Quality - Gasoline	184
Fuel Quality - Diesel	185
Fuel Filler Funnel Location	185
Running Out of Fuel	185
Refueling	187
Fuel Consumption	189

Engine Emission Control

Catalytic Converter	191
Gasoline Particulate Filter	192

Table of Contents

Diesel Particulate Filter193

Manual Transmission

Manual Transmission Precautions197

Shifting Into Reverse - 5-Speed Manual
Transmission197

Shifting Into Reverse - 6-Speed Manual
Transmission197

Manual Transmission Shift Indicators197

Checking the Clutch Fluid Level197

Clutch Fluid Specification197

Manual Transmission – Troubleshooting
.....198

Automatic Transmission

Automatic Transmission Precautions199

Automatic Transmission Positions199

Automatic Transmission Position Indicators
- 7-Speed Automatic Transmission,
Vehicles Without: Paddle Shifters200

Automatic Transmission Position Indicators
- 7-Speed Automatic Transmission,
Vehicles With: Paddle Shifters200

Automatic Transmission Shift Indicators -
Vehicles With: Paddle Shifters200

Manually Shifting Gears200

Brake Shift Interlock201

Automatic Transmission Audible Warnings
.....202

Automatic Transmission – Troubleshooting
.....202

Brakes

General Information203

Hints on Driving With Anti-Lock Brakes
.....203

Parking Brake - Manual Transmission203

Parking Brake - Automatic Transmission
.....204

Hill Start Assist204

Traction Control

Principle of Operation206

Using Traction Control206

Stability Control

Principle of Operation207

Using Stability Control207

Parking Aids

Principle of Operation208

Rear Parking Aid208

Front Parking Aid210

Side Sensing System212

Active Park Assist214

Rear View Camera217

Cruise Control

Principle of Operation220

Using Cruise Control220

Using Adaptive Cruise Control - Vehicles
With: Adaptive Cruise Control221

Using Adaptive Cruise Control - Vehicles
With: Adaptive Cruise Control With Stop
and Go232

Driving Aids

Speed Limiter243

Intelligent Speed Limiter243

Driver Alert246

Lane Keeping System248

Blind Spot Information System252

Cross Traffic Alert254

Traffic Sign Recognition258

Speed Sign Recognition260

Eco262

Pre-Collision Assist262

Drive Mode Control

What Is Drive Mode Control268

Table of Contents

Selecting a Drive Mode - Excluding: ST	268
Drive Modes	268
Drive Mode Control – Troubleshooting	269

Efficient Drive Mode

What Is Efficient Drive Mode	270
Switching Efficient Drive Mode On and Off	270
Displaying the Efficient Drive Mode	270
Trip Summary	270
Efficient Drive Mode Indicators	270

Local Hazard Information

What Is Local Hazard Information	271
Local Hazard Information Precautions	271
Enabling Local Hazard Information	271
Checking Local Hazard Information Status	271

Load Carrying

General Information	272
Rear Under Floor Storage	272
Luggage Covers	273

Roof Racks and Load Carriers - Vehicles Without: Panoramic Roof Opening Panel	273
Roof Racks and Load Carriers - Vehicles With: Panoramic Roof Opening Panel	274

Towing

Towing a Trailer - Excluding: ST	275
Towing a Trailer - ST	276
Tow Ball	276
Towing the Vehicle on Four Wheels - Manual Transmission	279
Towing the Vehicle on Four Wheels - Automatic Transmission	280

Driving Hints

Cold Weather Precautions	282
Breaking-In	282
Engine Overspeed	282
Driving Economically	282
Driving Through Shallow Water	283
Floor Mats	283

Roadside Emergencies

Hazard Flashers	285
First Aid Kit	285

Warning Triangle	285
Fuel Shutoff	285
Jump Starting the Vehicle	286
Towing Points	287

Crash and Breakdown Information

Post-Crash Alert System	289
Post Impact Braking	289

Fuses

Fuse Box Locations	290
Fuse Specification Chart	291
Changing a Fuse	302

Maintenance

General Information	304
Opening and Closing the Hood	304
Under Hood Overview - 1.0L EcoBoost™ LHD	306
Under Hood Overview - 1.0L EcoBoost™ RHD	308
Under Hood Overview - 1.1L Duratec, LHD	309
Under Hood Overview - 1.1L Duratec, RHD	310

Table of Contents

Under Hood Overview - 1.5L Duratorq-TDCi Diesel, LHD	311
Under Hood Overview - 1.5L Duratorq-TDCi Diesel, RHD	313
Under Hood Overview - 1.5L EcoBoost™, LHD	314
Under Hood Overview - 1.5L EcoBoost™, RHD	316
Engine Oil Dipstick - 1.0L EcoBoost™/1.1L Duratec	317
Engine Oil Dipstick - 1.5L Duratorq-TDCi Diesel	317
Engine Oil Dipstick - 1.5L EcoBoost™	317
Engine Oil Check	317
Oil Change Indicator Reset	318
Engine Cooling Fan - Gasoline	320
Engine Cooling Fan - Diesel	320
Engine Coolant Check	320
Brake Fluid Check	321
Clutch Fluid Check	322
Changing the 12V Battery	322
Washer Fluid Check	324
Checking the Wiper Blades	324
Changing the Front Wiper Blades	324
Changing the Rear Wiper Blades	324
Removing a Headlamp	325
Removing a Rear Lamp	326

Changing a Bulb	327
-----------------------	-----

Vehicle Care

Cleaning the Exterior	334
Cleaning the Interior	335
Repairing Minor Paint Damage	337
Waxing Your Vehicle	337

Wheels and Tires

General Information	339
Tire Sealant and Inflator Kit - Vehicles With: Temporary Mobility Kit	339
Tire Care	343
Using Winter Tires	344
Using Snow Chains	345
Changing a Road Wheel - Vehicles With: Spare Wheel	345
Tire Pressures - 1.0L EcoBoost™, Manual Transmission	353
Tire Pressures - 1.0L EcoBoost™, Automatic Transmission	356
Tire Pressures	360
Tire Pressures - 1.5L Diesel	364
Tire Pressures - 1.5L EcoBoost™	368
Lug Nuts	371

Tire Pressure Monitoring System

What Is the Tire Pressure Monitoring System	372
Tire Pressure Monitoring System Precautions	372
Tire Pressure Monitoring System Limitations	372
Viewing the Tire Pressures	372
Resetting Tire Pressure Monitoring System	372
Tire Pressure Monitoring System – Troubleshooting	373

Capacities and Specifications

Vehicle Dimensions	375
Towbar Dimensions	376
Capacities and Specifications - 1.0L EcoBoost™	378
Capacities and Specifications - 1.1L Duratec	380
Capacities and Specifications - 1.5L Duratorq-TDCi Diesel	383
Capacities and Specifications - 1.5L EcoBoost™	386
Bulb Specification Chart	389

Table of Contents

Fuel Consumption Figures - 1.0L EcoBoost™	392	Changing the Vehicle Wi-Fi Hotspot Name or Password	403	Using Voice Recognition	417
Fuel Consumption Figures - 1.1L Duratec	393	Audio System		Entertainment	425
Fuel Consumption Figures - 1.5L EcoBoost™	394	Audio Unit - Vehicles With: SYNC 3	404	Climate	427
Fuel Consumption Figures	395	Audio Unit - Vehicles With: SYNC 2.5	405	Phone	430
Vehicle Identification		AM/FM Radio - Vehicles With: SYNC 2.5	406	Navigation	432
Vehicle Identification Number	396	Digital Radio - Vehicles With: SYNC 2.5	406	Apps	437
Vehicle Identification Plate	396	Audio Unit Clock and Date Displays - Vehicles With: SYNC 2.5	407	Settings	438
Connected Vehicle		Connecting a Bluetooth® Device - Vehicles With: SYNC 2.5	407	SYNC™ 3 Troubleshooting	440
What Is a Connected Vehicle	399	Compact Disc Player - Vehicles With: SYNC 2.5	407	Appendices	
Connected Vehicle Requirements	399	Streaming Bluetooth Audio - Vehicles With: SYNC 2.5	408	Electromagnetic Compatibility	452
Connected Vehicle Limitations	399	Playing Media From a USB Device - Vehicles With: SYNC 2.5	408	End User License Agreement	456
Connecting the Vehicle to a Mobile Network	399	USB Port	409	Declaration of Conformity	483
Connecting the Vehicle to a Wi-Fi Network	399	Apps - Vehicles With: SYNC 2.5	409		
Connected Vehicle – Troubleshooting - Vehicles With: Modem	400	Using Voice Recognition	412		
Connected Vehicle – Troubleshooting - Vehicles With: SYNC 3/SYNC 2.5	401	Audio System – Troubleshooting - Vehicles With: SYNC 2.5	413		
Vehicle Wi-Fi Hotspot		SYNC™ 3			
Creating a Vehicle Wi-Fi Hotspot	403	General Information	415		

Introduction

ACKNOWLEDGMENTS

Your vehicle could have components that use open source software. For additional information, visit <http://corporate.ford.com/ford-open-source.html>.

ABOUT THIS MANUAL

Thank you for choosing Ford. We recommend that you take some time to get to know your vehicle by reading this manual. The more that you know about your vehicle, the greater the safety and pleasure you will get from driving it.



WARNING: Driving while distracted can result in loss of vehicle control, crash and injury. We strongly recommend that you use extreme caution when using any device that may take your focus off the road. Your primary responsibility is the safe operation of your vehicle. We recommend against the use of any hand-held device while driving and encourage the use of voice-operated systems when possible. Make sure you are aware of all applicable local laws that may affect the use of electronic devices while driving.

Note: This manual describes product features and options available throughout the range of available models, sometimes even before they are generally available. It may describe options not fitted to the vehicle you have purchased.

Note: Some of the illustrations in this manual may show features as used in different models, so may appear different to you on your vehicle.

Note: Always use and operate your vehicle in line with all applicable laws and regulations.

Note: Pass on this manual when selling your vehicle. It is an integral part of your vehicle.

This manual may qualify the location of a component as left-hand side or right-hand side. The side is determined when facing forward in the seat.

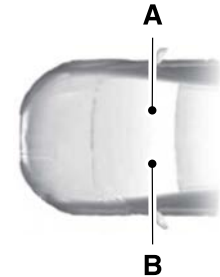

- A Right-hand side.
- B Left-hand side.

SYMBOLS GLOSSARY

These are some of the symbols you may see on your vehicle.



Safety alert.



See the Owner's Manual.



Air conditioning system.

Introduction



Anti-lock braking system.



Avoid smoking, flames or sparks.



Battery.



Battery acid.



Brake fluid level.



Brake system.



Brake failure.



Cabin air filter.



Check fuel cap.



Child safety door lock.



Child safety door unlock.



Child seat lower anchor.



Child seat tether anchor.



Cruise control.



Do not open when hot.



Electronic power steering malfunction.



Engine air filter.



Engine coolant.



Engine coolant temperature.



Engine oil.



Explosive gas.



Fan warning.



Fasten seatbelt.



Front airbag.



Front fog lamps.



Fuel pump reset.



Fuse compartment.



Hazard warning flashers.



Heated rear window.



Heated windshield.

Introduction



Interior luggage compartment release.



Jack.



Keep out of reach of children.



Lighting control.



Low tire pressure warning.



Maintain correct fluid level.



Panic alarm.



Parking aid.



Parking brake.



Power steering fluid.



Power windows.



Power window lockout.



Malfunction indicator lamp (MIL).



Service engine soon.



Side airbag.



Shield the eyes.



Stability control.



Windshield wash and wipe.

REACH

We are committed to promoting the responsible manufacturing, handling and use of our products and support the underlying goals of **REACH**, a European Union regulation that concerns the registration, evaluation, authorisation and restriction of chemicals.

We specifically support Regulation EC 1907/2006 Article 33(1) that relates to substances of very high concern which appear on the current list for authorisation.

If these substances do exist in a product, it is important to guarantee their safe use so the regulation is designed to enable you to take any appropriate risk management measures.

To find out more about the **REACH** directive, search **REACH** on the local Ford website.

Note: To find the local Ford website, visit <https://corporate.ford.com/operations/locations/global-links.html>.

Introduction

REPLACEMENT PARTS RECOMMENDATION

We have built your vehicle to the highest standards using quality parts. We recommend that you demand the use of genuine Ford and Motorcraft parts whenever your vehicle requires scheduled maintenance or repair. You can clearly identify genuine Ford and Motorcraft parts by looking for the Ford, FoMoCo or Motorcraft branding on the parts or their packaging.

Scheduled Maintenance and Mechanical Repairs

One of the best ways for you to make sure that your vehicle provides years of service is to have it maintained in line with our recommendations using parts that conform to the specifications detailed in this Owner's Manual.

Genuine Ford and Motorcraft parts meet or exceed these specifications.

Collision Repairs

We hope that you never experience a collision, but accidents happen sometimes.

Genuine Ford replacement collision parts meet our stringent requirements for fit, finish, structural integrity, corrosion protection and dent resistance. During vehicle development we validate that these parts deliver the intended level of protection as a whole system. A great way to know for sure you are getting this level of protection is to use genuine Ford replacement collision parts.

Warranty on Replacement Parts

Genuine Ford and Motorcraft replacement parts are the only replacement parts that benefit from a Ford Warranty.

The Ford Warranty may not cover damage caused to your vehicle as a result of failed non-Ford parts.

For additional information, refer to the terms and conditions of the Ford Warranty.

MOBILE COMMUNICATIONS EQUIPMENT



WARNING: Driving while distracted can result in loss of vehicle control, crash and injury. We strongly recommend that you use extreme caution when using any device that may take your focus off the road. Your primary responsibility is the safe operation of your vehicle. We recommend against the use of any hand-held device while driving and encourage the use of voice-operated systems when possible. Make sure you are aware of all applicable local laws that may affect the use of electronic devices while driving.

Using mobile communications equipment is becoming increasingly important in the conduct of business and personal affairs. However, you must not compromise your own or others' safety when using such equipment. Mobile communications can enhance personal safety and security when appropriately used, particularly in emergency situations. Safety must be paramount when

Introduction

using mobile communications equipment to avoid negating these benefits. Mobile communication equipment includes, but is not limited to, cellular phones, pagers, portable email devices, text messaging devices and portable two-way radios.

Data Privacy



WARNING: Do not connect wireless plug-in devices to the data link connector. Unauthorized third parties could gain access to vehicle data and impair the performance of safety related systems. Only allow repair facilities that follow our service and repair instructions to connect their equipment to the data link connector.

We respect your privacy and are committed to protecting it. The information contained in this manual was correct at the time of publication, but as technology rapidly changes, we recommend that you visit the local Ford website for the latest information.

Your vehicle has electronic control units that have data recording functionality and the ability to permanently or temporarily store data. This data could include information on the condition and status of your vehicle, vehicle maintenance requirements, events and malfunctions. The types of data that can be recorded are described in this section. Some of the data recorded is stored in event logs or error logs.

Note: *Error logs are reset following a service or repair.*

Note: *We may provide information in response to requests from law enforcement, other government authorities and third parties acting with lawful authority or through a legal process. Such information could be used by them in legal proceedings.*

Data recorded includes, for example:

- Operating states of system components, for example fuel level, tire pressure and battery charge level.
- Vehicle and component status, for example wheel speed, deceleration, lateral acceleration and seatbelt status.
- Events or errors in essential systems, for example headlamps and brakes.
- System responses to driving situations, for example airbag deployment and stability control.
- Environmental conditions, for example temperature.

Some of this data, when used in combination with other information, for example an accident report, damage to a vehicle or eyewitness statements, could be associated with a specific person.

Services That We Provide

If you use our services, we collect and use data, for example account information, vehicle location and driving characteristics, that could identify you. We transmit this data through a dedicated, protected connection. We only collect and use data to enable your use of our services to which you have subscribed, with your consent or where permitted by law. For additional information, see the terms and conditions of the services to which you have subscribed.

For additional information about our privacy policy, refer to the local Ford website.

Services That Third Parties Provide

We recommend that you review the terms and conditions and data privacy information for any services equipped with your vehicle or to which you subscribe. We take no responsibility for services that third parties provide.

Data Privacy

SERVICE DATA

Our dealers collect service data through the data link connector in your vehicle. They use service data, for example error logs, to help them if you take your vehicle for repair. They share this data with our technical team, if required, to help with diagnosis. In addition to using the information for diagnosis and repair, we use and share service data with our service providers, for example parts suppliers, where required and where permitted by law, for continuous improvement or with other information that we have about you, for example your contact information, to offer you products and services that may be of interest to you according to your preferences and where allowed by law. Our service providers are equally required by law to protect your data and retain it in accordance with data retention policies.

Note: *Third party repair facilities can also collect service data through the data link connector.*

EVENT DATA

This vehicle is equipped with an event data recorder. The main purpose of an event data recorder is to record, in certain crash or near crash-like situations, such as an airbag deployment or hitting a road obstacle; this data will assist in understanding how a vehicle's systems performed. The event data recorder is designed to record data related to vehicle dynamics and safety systems for a short period of time, typically 30 seconds or less.

The event data recorder in this vehicle is designed to record such data as:

- How various systems in your vehicle were operating.
- Whether or not the driver and passenger seatbelts were buckled/fastened.
- How far (if at all) the driver was depressing the accelerator and/or the brake pedal.
- How fast the vehicle was traveling.
- Where the driver was positioning the steering wheel.

This data can help provide a better understanding of the circumstances in which crashes and injuries occur.

Note: *Event data recorder data is recorded by your vehicle only if a non-trivial crash situation occurs; no data is recorded by the event data recorder under normal driving conditions and no personal data or information (for example name, gender, age, and crash location) is recorded. However, parties, such as law enforcement, could combine the event data recorder data with the type of personally identifying data routinely acquired during a crash investigation.*

To read data recorded by an event data recorder, special equipment is required, and access to the vehicle or the event data recorder is needed. In addition to the vehicle manufacturer, other parties, such as law enforcement, that have such special equipment, can read the information if they have access to the vehicle or the event data recorder.

Data Privacy

SETTINGS DATA

Your vehicle has electronic control units that have the ability to store data based on your personalized settings. The data is stored locally in the vehicle or on devices that you connect to it, for example, a USB drive or digital music player. You can delete some of this data and also choose whether to share it through the services to which you subscribe. See **Settings** (page 438).

Comfort and Convenience Data

Data recorded includes, for example:

- Seat and steering wheel position.
- Climate control settings.
- Radio presets.

Entertainment Data

Data recorded includes, for example:

- Music, videos or album art.
- Contacts and corresponding address book entries.
- Navigation destinations.

CONNECTED VEHICLE DATA - VEHICLES WITH: MODEM



The modem has a SIM. The modem was enabled when your vehicle was built and periodically sends messages to stay connected to the cell phone network, receive automatic software updates and send vehicle-related information to us, for example diagnostic information. These messages could include information that identifies your vehicle, the SIM and the electronic serial number of the modem. Cell phone network service providers could have access to additional information, for example cell phone network tower identification. For additional information about our privacy policy, visit www.FordConnected.com or refer to your local Ford website.

Note: *The modem continues to send this information unless you disable the modem or stop the modem from sharing vehicle data by changing the modem settings. See **Connected Vehicle** (page 399).*

Note: *The service can be unavailable or interrupted for a number of reasons, for example environmental or topographical conditions and data plan coverage.*

Note: *To find out if your vehicle has a modem, visit www.FordConnected.com.*

MOBILE DEVICE DATA - VEHICLES WITH: SYNC 3

If you connect a mobile device to your vehicle, you can display data from your device on the touchscreen for example, music and album art. You can share your vehicle data with mobile apps on your device through the system. See **Apps** (page 437).

The mobile apps function operates by your connected device sending data to us in the United States. The data is encrypted and includes, for example, the vehicle identification number of your vehicle, the SYNC module serial number, odometer, enabled apps, usage statistics and debugging information. We retain it only as long as necessary to provide the service, to troubleshoot, for continuous improvement and to offer you products and services that may be of interest to you according to your preferences and where allowed by law.

Data Privacy

If you connect a cell phone to the system, the system creates a profile that links to that cell phone. The cell phone profile enables more mobile features and efficient operation. The profile contains, for example data from your phonebook, read and unread text messages and call history, including history of calls when your cell phone was not connected to the system.

If you connect a media device, the system creates and retains a media device index of supported media content. The system also records a short diagnostic log of approximately 10 minutes of all recent system activity.

The cell phone profile, media device index and diagnostic log remain in your vehicle unless you delete them and are generally accessible only in your vehicle when you connect your cell phone or media device. If you no longer plan to use the system or your vehicle, we recommend you use the master reset function to erase the stored information. See **Settings** (page 438).

System data cannot be accessed without special equipment and access to your vehicle's module.

For additional information about our privacy policy, refer to the local Ford website.

Note: *To find out if your vehicle has connectivity technology, visit www.FordConnected.com.*

EMERGENCY CALL SYSTEM DATA

When the emergency call system is active, it may disclose to emergency services that your vehicle has been in a crash involving the deployment of an airbag or activation of the fuel pump shut-off. Certain versions or updates to the emergency call system may also be capable of electronically or verbally disclosing to emergency services operators your vehicle location or other details about your vehicle or crash to assist emergency services operators to provide the most appropriate emergency services. If you do not want to disclose this information, do not activate the emergency call system.

Note: *You cannot deactivate emergency call systems that are required by law.*

Environment

PROTECTING THE ENVIRONMENT

You should play your part in protecting the environment. Correct vehicle usage and the authorized disposal of waste, cleaning and lubrication materials are significant steps toward this aim.

For additional information about our sustainability progress and initiatives, visit www.sustainability.ford.com.

Visual Search

STEERING WHEEL - EXCLUDING: ST



- A Cruise control button. See **Using Cruise Control** (page 220).
- B Speed limiter button. See **Intelligent Speed Limiter** (page 243).
- C Voice control button. See **Using Voice Recognition** (page 412). See **Using Voice Recognition** (page 417).
- D Information display controls. See **General Information** (page 116).

STEERING WHEEL - ST



- A Cruise control button. See **Using Cruise Control** (page 220).
- B Speed limiter button. See **Speed Limiter** (page 243).
- C Sport mode button. See **Selecting a Drive Mode** (page 268). See **Selecting a Drive Mode** (page 268).
- D Information display controls. See **General Information** (page 116).

- E Drive mode button. See **Selecting a Drive Mode** (page 268). See **Selecting a Drive Mode** (page 268).
- F Voice control button. See **Using Voice Recognition** (page 412). See **Using Voice Recognition** (page 417).

Visual Search

INSTRUMENT PANEL - LHD

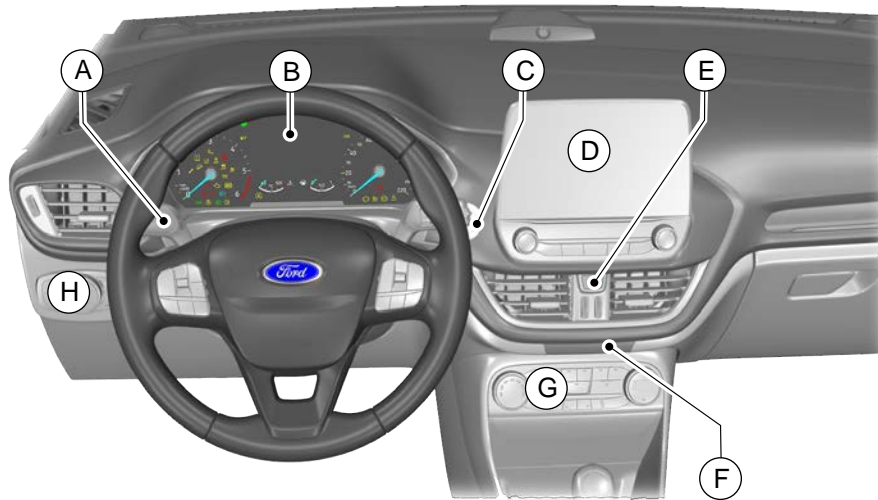

- A Lane keeping system button. See **Lane Keeping System** (page 248).
- B Instrument cluster. See **Gauges** (page 108).

Visual Search

- C Push button ignition switch. See **Push Button Ignition Switch** (page 159).
- D Audio unit. See **Audio System** (page 404). See **SYNC™ 3** (page 415).
- E Hazard flasher switch. See **Hazard Flashers** (page 285).
- F Passenger airbag deactivation indicator. See **Switching the Passenger Airbag On and Off** (page 47).
- G Climate controls. See **Climate Control** (page 139).
- H Lighting control. See **Lighting Control** (page 88).

Visual Search

INSTRUMENT PANEL - RHD

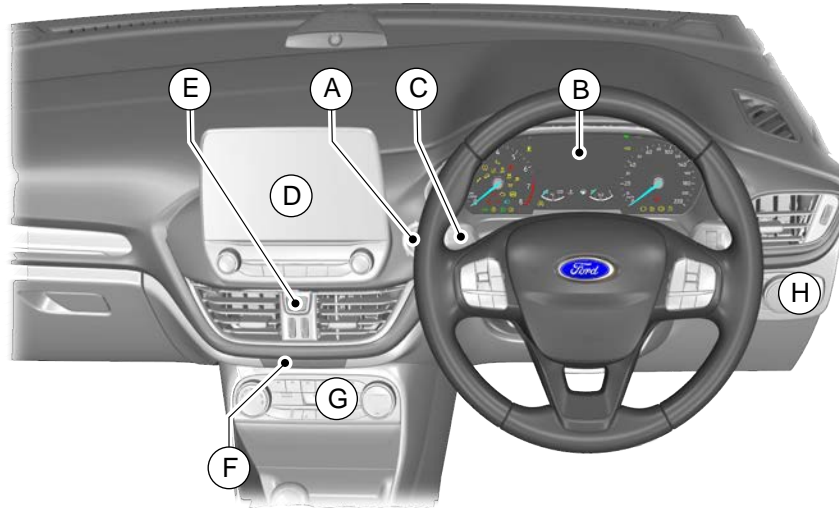

- A Push button ignition switch. See **Push Button Ignition Switch** (page 159).
- B Instrument cluster. See **Gauges** (page 105).

Visual Search

- C Lane keeping system button. See **Lane Keeping System** (page 248).
- D Audio unit. See **Audio System** (page 404). See **SYNC™ 3** (page 415).
- E Hazard flasher switch. See **Hazard Flashers** (page 285).
- F Passenger airbag deactivation indicator. See **Switching the Passenger Airbag On and Off** (page 47).
- G Climate controls.
- H Lighting control. See **Lighting Control** (page 88).

Visual Search

CENTER CONSOLE - LIQUEFIED PETROLEUM GAS (LPG), VEHICLES WITHOUT: ACTIVE PARK ASSIST/FRONT PARKING AID

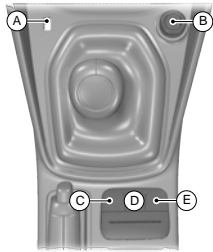

- A USB port. See **USB Port** (page 409).
- B Auxiliary power point. See **Auxiliary Power Points** (page 154).
- C LPG button.
- D Traction control switch. See **Using Traction Control** (page 206).
- E Auto-start-stop-button. See **Auto-Start-Stop** (page 171).

CENTER CONSOLE - LIQUEFIED PETROLEUM GAS (LPG), VEHICLES WITH: ACTIVE PARK ASSIST/FRONT PARKING AID/ REAR PARKING AID

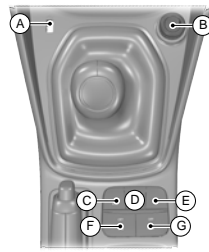

- A USB port. See **USB Port** (page 409).
- B Auxiliary power point. See **Auxiliary Power Points** (page 154).
- C LPG button.
- D Traction control switch. See **Using Traction Control** (page 206).
- E Active park assist button. See **Active Park Assist** (page 214).

- F Auto-Start-Stop button. See **Auto-Start-Stop** (page 171).
- G Parking aid button. See **Rear Parking Aid** (page 208). See **Front Parking Aid** (page 210).

Visual Search

CENTER CONSOLE - MANUAL TRANSMISSION, LHD, VEHICLES WITHOUT: ACTIVE PARK ASSIST/FRONT PARKING AID/REAR PARKING AID, EXCLUDING: LIQUEFIED PETROLEUM GAS (LPG)

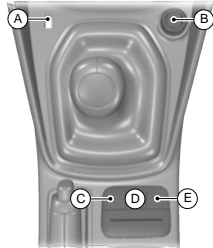

- A USB port. See **USB Port** (page 409).
- B Auxiliary power point. See **Auxiliary Power Points** (page 154).
- C Drive control button. See **Selecting a Drive Mode** (page 268).

- D Traction control button. See **Using Traction Control** (page 206).
- E Auto-start-stop button. See **Auto-Start-Stop** (page 171).

CENTER CONSOLE - MANUAL TRANSMISSION, LHD, VEHICLES WITH: ACTIVE PARK ASSIST/FRONT PARKING AID/REAR PARKING AID, EXCLUDING: LIQUEFIED PETROLEUM GAS (LPG)

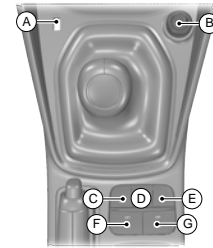

- A USB port. See **USB Port** (page 409).
- B Auxiliary power point. See **Auxiliary Power Points** (page 154).
- C Drive control button. See **Selecting a Drive Mode** (page 268).

Visual Search

- D Traction control button. See **Using Traction Control** (page 206).
- E Active park assist button. See **Active Park Assist** (page 214).
- F Auto-start-stop button. See **Auto-Start-Stop** (page 171).
- G Parking aid button. See **Rear Parking Aid** (page 208). See **Front Parking Aid** (page 210).

CENTER CONSOLE - MANUAL TRANSMISSION, RHD, VEHICLES WITHOUT: ACTIVE PARK ASSIST/FRONT PARKING AID/REAR PARKING AID, EXCLUDING: LIQUEFIED PETROLEUM GAS (LPG)

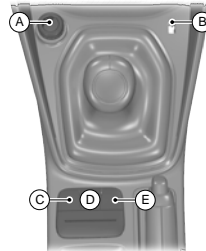

- D Traction control button. See **Using Traction Control** (page 206).
- E Auto-start-stop button. See **Auto-Start-Stop** (page 171).

- A Auxiliary power point. See **Auxiliary Power Points** (page 154).
- B USB port. See **USB Port** (page 409).
- C Drive control button. See **Selecting a Drive Mode** (page 268).

Visual Search

CENTER CONSOLE - MANUAL TRANSMISSION, RHD, VEHICLES WITH: ACTIVE PARK ASSIST/FRONT PARKING AID/REAR PARKING AID, EXCLUDING: LIQUEFIED PETROLEUM GAS (LPG)

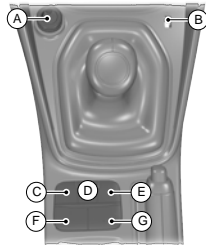

- A Auxiliary power point. See **Auxiliary Power Points** (page 154).
- B USB port. See **USB Port** (page 409).
- C Drive control button. See **Selecting a Drive Mode** (page 268).

- D Traction control button. See **Using Traction Control** (page 206).
- E Active park assist button. See **Active Park Assist** (page 214).
- F Auto-start-stop button. See **Auto-Start-Stop** (page 171).
- G Parking aid button. See **Rear Parking Aid** (page 208). See **Front Parking Aid** (page 210).

CENTER CONSOLE - 7-SPEED AUTOMATIC TRANSMISSION, LHD, VEHICLES WITHOUT: ACTIVE PARK ASSIST/FRONT PARKING AID/REAR PARKING AID, EXCLUDING: LIQUEFIED PETROLEUM GAS (LPG)

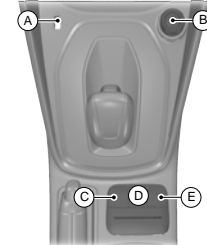

- A USB port. See **USB Port** (page 409).
- B Auxiliary power point. See **Auxiliary Power Points** (page 154).
- C Drive control button. See **Selecting a Drive Mode** (page 268).

Visual Search

- D Traction control switch. See **Using Traction Control** (page 206).
- E Auto-start-stop button. See **Auto-Start-Stop** (page 172).

CENTER CONSOLE - 7-SPEED AUTOMATIC TRANSMISSION, LHD, VEHICLES WITH: ACTIVE PARK ASSIST/FRONT PARKING AID/REAR PARKING AID, EXCLUDING: LIQUEFIED PETROLEUM GAS (LPG)

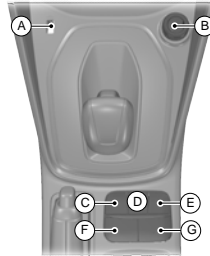

- D Traction control switch. See **Using Traction Control** (page 206).
- E Active park assist button. See **Active Park Assist** (page 214).
- F Auto-Start-Stop button. See **Auto-Start-Stop** (page 172).
- G Parking aid button. See **Rear Parking Aid** (page 208). See **Front Parking Aid** (page 210).

- A USB port. See **USB Port** (page 409).
- B Auxiliary power point. See **Auxiliary Power Points** (page 154).
- C Drive control button. See **Selecting a Drive Mode** (page 268).

Visual Search

CENTER CONSOLE - 7-SPEED AUTOMATIC TRANSMISSION, RHD, VEHICLES WITHOUT: ACTIVE PARK ASSIST/FRONT PARKING AID/REAR PARKING AID, EXCLUDING: LIQUEFIED PETROLEUM GAS (LPG)

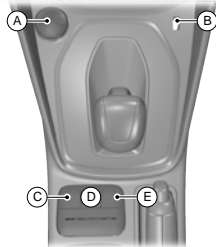

- A Auxiliary power point. See **Auxiliary Power Points** (page 154).
- B USB port. See **USB Port** (page 409).
- C Drive control button. See **Selecting a Drive Mode** (page 268).

- D Traction control switch. See **Using Traction Control** (page 206).
- E Auto-start-stop button. See **Auto-Start-Stop** (page 172).

CENTER CONSOLE - 7-SPEED AUTOMATIC TRANSMISSION, RHD, VEHICLES WITH: ACTIVE PARK ASSIST/FRONT PARKING AID/REAR PARKING AID, EXCLUDING: LIQUEFIED PETROLEUM GAS (LPG)

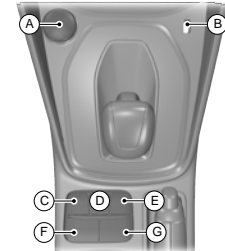

- A Auxiliary power point. See **Auxiliary Power Points** (page 154).
- B USB port. See **USB Port** (page 409).
- C Drive control button. See **Selecting a Drive Mode** (page 268).

Visual Search

- D Traction control switch. See **Using Traction Control** (page 206).
- E Active park assist button. See **Active Park Assist** (page 214).
- F Auto-Start-Stop button. See **Auto-Start-Stop** (page 172).
- G Parking aid button. See **Rear Parking Aid** (page 208). See **Front Parking Aid** (page 210).

Child Safety

INSTALLING CHILD RESTRAINTS



E161855



E68916

⚠ WARNING: Extreme Hazard! Never use a rearward facing child restraint on a seat protected by an active airbag in front of it. Death or serious injury to the child can occur.

⚠ WARNING: You must switch the passenger airbag off when using a rearward facing child restraint on the front seat.

⚠ WARNING: You must switch the passenger airbag on following the removal of the child restraint.

⚠ WARNING: Read and follow the manufacturer's instructions when you are installing a child restraint.

⚠ WARNING: Do not modify child restraints in any way.

⚠ WARNING: Do not hold a child on your lap when your vehicle is moving.

⚠ WARNING: Do not leave children or pets unattended in your vehicle. Failure to follow this instruction could result in personal injury or death.

⚠ WARNING: If your vehicle has been involved in a crash, have the child restraints checked.

Only child restraints certified to ECE-R129 or ECE-R44.03 (or later) have been tested and approved for use in your vehicle. A choice of these are available from an authorized dealer.

Note: *Mandatory use of child restraints varies from country to country.*

When using a child restraint on a front seat, follow these seat positioning guidelines:

- The child restraint must not be in contact with the instrument panel.
- Position the passenger seat as far rearward as possible and route the seatbelt forward and downward from the B-pillar ring to the child restraint.
- If it proves difficult to tighten the lap section of the seatbelt without slack remaining, adjust the seat backrest to the fully upright position and raise the height of the seat.

Note: *When using a child restraint on a rear seat, adjust the front seat to a position to prevent contact with the child's feet or legs.*

Child Safety

Child Restraints for Different Mass Groups

Use the correct child restraint as follows:

Baby Safety Restraint (Group 0+)



Secure children that weigh less than 13 kg (29 lb) in a rearward facing baby safety restraint (Group 0+) on the rear seat.

Child Safety Restraint (Group 1)



Secure children that weigh between 13 kg (29 lb) and 18 kg (40 lb) in a child safety restraint (Group 1) on the rear seat.

Booster Seats

⚠ WARNING: Do not install a booster seat or a booster cushion with only the lap strap of the seatbelt.

⚠ WARNING: Do not install a booster seat or a booster cushion with a seatbelt that is slack or twisted.

⚠ WARNING: Do not put the seatbelt under your child's arm or behind its back.

⚠ WARNING: Do not use pillows, books or towels to boost your child's height.

⚠ WARNING: Make sure that your children sit in an upright position.

⚠ WARNING: Make sure the child restraint rests tightly against the vehicle seat. If necessary, adjust the seat backrest to an upright position. It may also be necessary to lift or remove the head restraint.

⚠ WARNING: You must reinstall the head restraint following the removal of the child restraint.

Child Safety

Booster Seat (Group 2)



Secure children that weigh greater than 15 kg (33 lb) but are less than 150 cm (60 in) tall in a booster seat or on a booster cushion.

We recommend that you use a booster seat that combines a cushion with a backrest instead of a booster cushion only. The raised seating position will allow you to position the shoulder strap of the adult seatbelt over the center of your child's shoulder and the lap strap tightly across their hips.

Booster Cushion (Group 3)

 **WARNING:** When using a booster cushion, make sure you adjust the vehicle head restraint on that seating position.



Secure children that weigh greater than 22 kg (49 lb) but are less than 150 cm (60 in) tall on a booster cushion.

ISOFIX Anchor Points

 **WARNING:** Use an anti-rotation device when using the ISOFIX system. We recommend the use of a top tether or support leg.

Your vehicle has ISOFIX anchor points that accommodate universally approved ISOFIX child restraints.

Always follow the manufacturer's instructions for installing a child restraint with a top tether.



E174928

The ISOFIX system has two rigid attachment arms on the child restraint. These attach to anchor points on the outermost rear seats, where the cushion and backrest meet.

Child Safety

Note: If you are purchasing an ISOFIX child restraint, make sure that you know the correct mass group and ISOFIX size class for the intended seating locations. See **Child Restraint Positioning** (page 37).

Top Tether Anchor Points



E87146

For child restraints with a top tether, tether anchor points are on the rear of the second row seats.

Attaching a Child Restraint With Top Tethers

 **WARNING:** Do not attach the top tether strap to anything other than the correct top tether strap anchor point.

 **WARNING:** Make sure that the top tether strap is not slack or twisted and is properly located on the anchor point.

1. Attach the tether strap to the anchor point.

Note: Where applicable, remove the luggage cover to ease installation. See **Luggage Covers** (page 273).

Note: You may need to lift or remove the head restraint to ease installation. See **Head Restraints** (page 145).



2. Push the child restraint back firmly to engage the ISOFIX lower anchor points.
3. Tighten the tether strap in line with the child restraint manufacturer's instructions.

Attaching a Child Restraint With a Support Leg

 **WARNING:** If you use a child restraint that has a support leg, make sure the support leg rests securely on the floor.

Child Safety

⚠ WARNING: Always make sure your child is secured properly in a device that is appropriate for their height, age and weight. Child safety restraints must be bought separately from your vehicle. Failure to follow these instructions and guidelines may result in an increased risk of serious injury or death to your child.

⚠ WARNING: Make sure that the child restraint manufacturer lists your vehicle as suitable for use with this type of child restraint.



E185352

Always follow the manufacturer's instructions for installing a child restraint with a support leg.

CHILD RESTRAINT POSITIONING

⚠ WARNING: Extreme Hazard! Never use a rearward facing child restraint on a seat protected by an active airbag in front of it. Death or serious injury to the child can occur.

⚠ WARNING: If you use a child restraint that has a support leg, make sure the support leg rests securely on the floor.

⚠ WARNING: If you use a child restraint and a seatbelt, make sure that the seatbelt is not slack or twisted.

⚠ WARNING: Make sure the child restraint rests tightly against the vehicle seat. If necessary, adjust the seat backrest to an upright position. It may also be necessary to lift or remove the head restraint.

⚠ WARNING: You must reinstall the head restraint following the removal of the child restraint.

Child Safety

Seating Positions	Mass Group Categories				
	0	0+	1	2	3
	0–10 kg (0–22 lb)	0–13 kg (0–29 lb)	9–18 kg (20–40 lb)	15–25 kg (33–55 lb)	22–36 kg (49–79 lb)
Front passenger seat with airbag ON.	X	X	UF ¹	UF ¹	UF ¹
Front passenger seat with airbag OFF.	U ¹	U ¹	U ¹	U ¹	U ¹
Rear seats. ²	U	U	U	U	U

¹ We recommend that you secure children in a government approved child restraint, on the rear seat.

² Do not use a child restraint with a support leg on the rear center seat unless stated as suitable in the child restraint manufacturer's product information.

X Not suitable for children in this mass group.

U Suitable for universal category child restraints approved for use in this mass group.

UF Suitable for universal category forward facing child restraints approved for use in this mass group.

Child Safety

ISOFIX Child Restraints

Seating Positions		Mass Group Categories				
		0	0	0+	1	1
		Lateral Facing	Rearward Facing	Rearward Facing	Forward Facing	Rearward Facing
		0–10 kg (0–22 lb)	0–10 kg (0–22 lb)	0–13 kg (0–29 lb)	9–18 kg (20–40 lb)	9–18 kg (20–40 lb)
Front passenger seat.	Size class.	No ISOFIX				
	Size type.					
Rear outermost seat ISOFIX.	Size class.	F, G ¹	E ¹	C, D, E ¹	A, B, B1 ¹	C, D ¹
	Fixture.	L1, L2 ¹	R1 ¹	R1, R2X, R2, R3 ¹	F2, F2X, F3 ¹	R2X, R2, R3 ¹
	Size type.	IL	IL	IL	IL, IUF	IL
Rear center seat.	Size class.	No ISOFIX				
	Size type.					

¹ The size class and fixture are defined for both universal and semi-universal child restraint systems. You can see the identification letters on ISOFIX child restraints.

IL Suitable for use with particular ISOFIX child restraint systems in the semi-universal category. Refer to the child restraint system manufacturer vehicle recommendation list for additional information.

IUF Suitable for use with forward facing ISOFIX child restraint systems in the universal category.

Child Safety

Recommended Child Restraints

Mass Group Categories	Manufacturer	Model	Attachment
0+ 0–13 kg (0–29 lb)	Britax Römer.	Baby Safe Plus with ISOFIX base. ¹	ISOFIX base or seatbelt only.
1 9–18 kg (20–40 lb)	Britax Römer.	Duo Plus. ¹	ISOFIX and top tether anchors or seatbelt only.
2 15–25 kg (33–55 lb)	Britax Römer.	KidFix. ^{1, 2}	ISOFIX and seatbelt or seatbelt only.
3 22–36 kg (49–79 lb)	Britax Römer.	KidFix. ^{1, 2}	ISOFIX and seatbelt or seatbelt only.

¹We recommend that you secure children using an ISOFIX child restraint on the rear outermost seats.

²We recommend that you use a booster seat that combines a cushion with a backrest instead of a booster cushion only.

See an authorized dealer for the latest details relating to our recommended child restraints.

Child Safety

i-Size Child Restraints

	Front Passenger Seat	Rear Outermost Seats	Rear Center Seat
Rearward facing child restraint systems on front passenger seat with airbag ON .	X	-	-
i-Size child restraint systems.	X	i-U	X
Suitable booster fixture.	B2, B3 ¹	B2, B3 ¹	B2, B3 ¹

¹The fixture is defined for booster child restraint systems. You can see the identification letters on i-Size boosters.

i-U Suitable for use with forward and rearward facing i-Size child restraint systems.

X Not suitable for use with i-Size child restraint systems.

Child Safety

CHILD SAFETY LOCKS

 **WARNING:** You cannot open the rear doors from inside if you have put the child safety locks on.



A child safety lock is on the rear edge of each rear door. You must set the child safety lock separately on each door.

Left-Hand Side

Turn the key clockwise to switch the child lock on and counterclockwise to switch it off.

Right-Hand Side

Turn the key counterclockwise to switch the child lock on and clockwise to switch it off.

Seatbelts

FASTENING THE SEATBELTS

WARNING: Make sure that the seatbelts are securely stowed away when not in use and not outside your vehicle when closing the doors.

WARNING: Accessory seat covers not released by Ford could prevent the seatbelt from retracting correctly. This could cause the seatbelt to become slack which could increase the risk of injuries in a crash.



1. Pull the seatbelt out steadily.

Note: *It may lock if you pull it sharply or if the vehicle is on a slope.*

2. Insert the tongue into the buckle until you hear a distinct click.

Press the red button on the buckle to release the seatbelt. Hold the seatbelt tongue and let it retract completely and smoothly to its stowed position.

Using Seatbelts During Pregnancy

WARNING: Position the seatbelt correctly for your safety and that of your unborn child. Do not use only the lap strap or the shoulder strap.

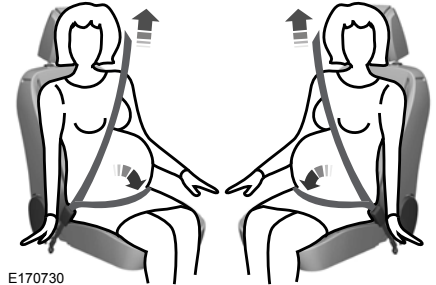

E170730

Pregnant women should always wear their seatbelt. The lap belt portion of a combination lap and shoulder belt should be positioned low across the hips below the belly and worn as tight as comfort will allow. The shoulder belt portion of a combination lap and shoulder belt should be positioned to cross the middle of the shoulder and the center of the chest.

Seatbelts

SEATBELT REMINDER

Fasten Seatbelt Warning Lamp

A warning lamp illuminates if the ignition is on and any of the following occur:

- A front seat is occupied and the seatbelt has not been fastened.
- A rear seatbelt has been recently unfastened.



The warning lamp illuminates until you fasten your seatbelt.

Fasten Seatbelt Audible Warning

A warning tone sounds if the warning lamp illuminates and your vehicle exceeds a relatively low speed.

The warning tone sounds for up to five minutes or until you fasten your seatbelt.

Switching the Audible Warning Off

We recommend that you contact an authorized dealer.

Seatbelt Status

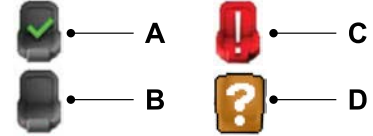

- A Seatbelt fastened.
- B Seatbelt not fastened.
- C Rear seatbelt recently unfastened.
- D Fault.

To view the seatbelt status, use the information display controls on the steering wheel to select the following:

Menu Item	Action
Settings	Press the menu button.
Information	Press the OK button.
Seatbelts	Press the OK button.

Seatbelts

Seatbelt Status Information Messages

Message	Description
Rear belt monitor malfunction Service required	The system has detected a fault that requires service. Have your vehicle checked as soon as possible.

Supplementary Restraints System

PRINCIPLE OF OPERATION

WARNING: Extreme Hazard! Never use a rearward facing child restraint on a seat protected by an active airbag in front of it. Death or serious injury to the child can occur.

WARNING: Do not modify the front of your vehicle in any way. This could adversely affect deployment of the airbags. Failure to adhere to this warning could result in serious personal injury or death.

WARNING: Wear a seatbelt and keep sufficient distance between yourself and the steering wheel. Only when you use the seatbelt correctly, can it hold you in a position that allows the airbag to achieve its optimum effect. Failure to adhere to this warning could result in serious personal injury or death.

WARNING: Repairs to the steering wheel, steering column, seats, airbags and seatbelts must be carried out by an authorized dealer. Failure to adhere to this warning could result in serious personal injury or death.

WARNING: Keep the areas in front of the airbags free from obstruction. Do not affix anything to or over the airbag covers. Objects could become projectiles during airbag deployment. Failure to follow this instruction could result in personal injury or death.

WARNING: Do not poke sharp objects into areas where airbags are fitted. This could damage and adversely affect deployment of the airbags. Failure to follow this instruction could result in personal injury or death.

WARNING: Accessory seat covers not released by Ford Motor Company could prevent the deployment of the airbags and increase the risk of injuries in a crash.

Note: A loud bang sounds and there is a cloud of harmless powdery residue if an airbag deploys. This is normal.

For routine cleaning, wipe the surface with a soft, damp cloth.

DRIVER AIRBAG

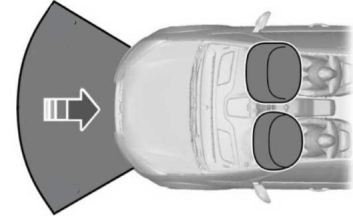

The airbag is designed to deploy during a significant frontal or near-frontal crash. The airbag inflates within a few thousandths of a second cushioning forward body movement and deflates on contact with the occupant. The airbag is not designed to deploy during a minor frontal crash, rear crash, side crash or a vehicle rollover.

Supplementary Restraints System

PASSENGER AIRBAG

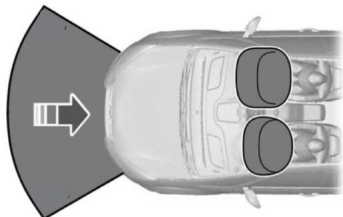

The airbag is designed to deploy during a significant frontal or near-frontal crash. The airbag inflates within a few thousandths of a second cushioning forward body movement and deflates on contact with the occupant. The airbag is not designed to deploy during a minor frontal crash, rear crash, side crash or a vehicle rollover.

SWITCHING THE PASSENGER AIRBAG ON AND OFF



E71313

The passenger airbag on and off indicators are close to the climate control unit.

Switching the Passenger Airbag Off

WARNING: You must switch the passenger airbag off when using a rearward facing child restraint on the front seat.

1. Using the information display controls on the steering wheel, select **Settings**.
2. Select **Vehicle settings**.
3. Select **Passenger airbag**.
4. Select **Off**.
5. Press and hold the **OK** button until a confirmation message appears in the information display.
6. Switch the ignition off and on and check that the passenger airbag off indicator illuminates.

Note: If it does not illuminate, this indicates a malfunction. Have your vehicle checked as soon as possible.

Switching the Passenger Airbag On

WARNING: You must switch the passenger airbag on following the removal of the child restraint.

1. Using the information display controls on the steering wheel, select **Settings**.
2. Select **Vehicle settings**.
3. Select **Passenger airbag**.
4. Select **On**.

Supplementary Restraints System

5. Press and hold the **OK** button until a confirmation message appears in the information display.
6. Switch the ignition off and on and check that the passenger airbag on indicator illuminates.

Note: *If it does not illuminate, this indicates a malfunction. Have your vehicle checked as soon as possible.*

SIDE AIRBAGS

WARNING: Do not place objects or mount equipment on or near the headliner at the siderail that may come into contact with a deploying curtain airbag. Failure to follow these instructions may increase the risk of personal injury in the event of a crash.

WARNING: Do not lean your head on the door. The side airbag could injure you as it deploys from the side of the seatback.

WARNING: Accessory seat covers not released by Ford Motor Company could prevent the deployment of the airbags and increase the risk of injuries in a crash.

WARNING: Do not attempt to service, repair, or modify the supplementary restraint system or associated components. Failure to follow this instruction could result in personal injury or death.

WARNING: If a supplementary restraint system component has deployed, it will not function again. Have the system and associated components inspected as soon as possible. Failure to follow this instruction could result in personal injury or death.



E72658

The side airbags are on the outermost side of each front seat backrest. There is a label attached to the side of each backrest to indicate this.



The side airbags are designed to inflate between the door panel and the occupant to enhance the protection in certain crashes.

The airbag is designed to deploy during a significant lateral crash. It might also deploy during a significant frontal crash. The airbag is not designed to deploy during a minor lateral or frontal crash, rear crash or a vehicle rollover.

Supplementary Restraints System

SIDE CURTAIN AIRBAGS



WARNING: Do not place objects or mount equipment on or near the headliner at the siderall that may come into contact with a deploying curtain airbag. Failure to follow these instructions may increase the risk of personal injury in the event of a crash.

The airbag is designed to deploy during a significant lateral or frontal angled crash. The airbag is not designed to deploy during a minor lateral and frontal crash, rear crash or a vehicle rollover.

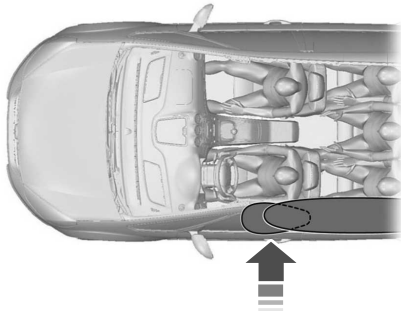

The airbags are above the front and rear side windows.

Automatic Crash Notification System

EMERGENCY ASSISTANCE



WARNING: Unless the Emergency Assistance setting is on prior to a collision, the system does not attempt to place an emergency call. This could delay the response time, increasing the risk of serious injury or death.



WARNING: For this feature to work, your mobile phone must be Bluetooth-enabled and compatible with the system.



WARNING: Always place your phone in a secure location in your vehicle so it does not become a projectile or get damaged in a crash. Failure to do so may cause serious injury to someone or damage the phone which could prevent Emergency Assistance from working properly.

Note: *Not all accidents activate the system. If an accident does trigger the system, it initiates a call to the emergency services. Do not wait for the system to initiate a call if you are able to do so. Call emergency services immediately to avoid a delayed response time. If you do not hear the system within five seconds of the accident, the system could be non-functional.*

If an accident results in an attempt to deploy an airbag, excluding knee airbags and rear inflatable seatbelts, or to shut off the fuel pump, the system initiates a call to the emergency services.

Note: *Before setting the feature on, please read the important notice about the Emergency Assistance feature and the Emergency Assistance privacy notice later in this section for important information.*

Note: *When you switch Emergency Assistance on or off, the settings apply to all paired mobile phones. If you switch Emergency Assistance off and a previously paired phone connects when you switch the ignition on, either a voice message plays, a display message or icon is shown or both.*

Note: *Every mobile phone operates differently. While Emergency Assistance works with most mobile phones, some mobile phones may experience difficulties using this feature.*

Note: *In the case of an emergency, the system, as a means of communication aid, can help you contact specific rescue departments of public emergency services. The system does not deploy the rescue operations. The local public emergency service deploys specific rescue operations according to the actual situation.*

To make sure that Emergency Assistance works correctly:

- The system must have power and be working correctly at the time of the crash and during feature activation and use.
- You must switch on the feature before a crash.
- You must have a cell phone connected to the system.
- In certain countries, it may be necessary to have a valid and registered SIM card with credit in order to place and maintain an emergency call.
- A connected cell phone must have the ability to make and maintain an outgoing call at the time of the crash.
- A connected cell phone must have adequate network coverage, battery power and signal strength.
- Your vehicle must have battery power.

Automatic Crash Notification System

Note: This feature only works in a country where Emergency Assistance can call the local emergency services. For additional information, please refer to the local Ford website.

In the Event of a Crash

Before making a call:

- If you do not cancel the call, an introductory message plays for the emergency operator. After this message, there is hands-free communication between your vehicle's occupants and the operator.
- The system provides a short window of time (approximately 10 seconds) to cancel the call. If you do not cancel the call, the system initiates a call to the emergency services.
- The system plays a message letting you know when it attempts to make an emergency call. You can cancel the call by selecting the relevant button or by pressing the end call button on the steering wheel.

Note: Not every crash deploys an airbag or triggers the fuel pump shut off, which may turn on Emergency Assistance. However, if Emergency Assistance is triggered, the system tries to contact the emergency services. If a connected cell phone sustains damage or loses connection to the system, it searches for and tries to connect to any available previously paired cell phone and initiates a call to the emergency services.

During a call:

- Emergency Assistance uses your vehicle GPS or cellular network information when available to determine the most appropriate language to use. It alerts the emergency operator of the crash and delivers the introductory message. This may include your vehicle GPS coordinates.
- The language the system uses to interact with the occupants of your vehicle may differ from the language used to deliver information to the emergency operator.

- After the delivery of the introductory message the voice line opens so that you can speak hands-free with the emergency operator.
- When the line is connected, you must be prepared to provide your name, phone number and location information immediately.

Note: While the system provides information to the emergency operator, the system plays a message letting you know it is sending important information. It then lets you know when the line is open to start hands-free communication.

Note: During an Emergency Assistance call, an emergency priority screen appears which contains vehicle GPS coordinates when available.

Note: It is possible that GPS location information is not available at the time of the crash; in this case, Emergency Assistance will still attempt to place an emergency call.

Note: It is possible that the emergency services will not receive the GPS coordinates; in this case, hands-free communication with an emergency operator is available.

Automatic Crash Notification System

Note: *The emergency operator may also receive information from the cellular network such as cell phone number, cell phone location and cell phone carrier name independent from Emergency Assistance.*

Emergency Assistance may not work if:

- Your cell phone or Emergency Assistance hardware sustains damage in the crash.
- The vehicle battery or the system has no power.
- A crash ejects your cell phone from your vehicle.
- You do not have a valid and registered SIM card with credit in your cell phone.
- You are in a country where Emergency Assistance cannot call the local emergency services. For additional information, please refer to the local Ford website.

Important Information About Emergency Assistance

Emergency Assistance does not currently call emergency services in the following countries:

- Albania.
- Armenia.

- Azerbaijan.
- Belarus.
- Bosnia and Herzegovina.
- Georgia.
- Macedonia.
- Moldova.
- Netherlands.
- Russia.
- Ukraine.

Emergency Assistance Privacy Notice

When you switch on Emergency Assistance, it may disclose to emergency services that your vehicle has been in a crash involving the deployment of an airbag or activation of the fuel pump shut off. This feature has the capability to disclose your location information to the emergency operator or other details about your vehicle or crash to provide the most appropriate emergency services.

If you do not want to disclose this information, do not switch on the feature.

Keys and Remote Controls

GENERAL INFORMATION ON RADIO FREQUENCIES

Note: Changes or modifications not expressly approved by the party responsible for compliance could void the user's authority to operate the equipment.

The typical operating range for your transmitter is approximately 10 m (33 ft).

A decrease in operating range could be caused by:

- weather conditions
- nearby radio towers
- structures around your vehicle
- other vehicles parked next to your vehicle.

The radio frequency used by your remote control can also be used by other radio transmitters, for example amateur radios, medical equipment, wireless headphones, wireless remote controls, cell phones, battery chargers and alarm systems. If the frequencies are jammed, you will not be able to use your remote control. You can lock and unlock the doors with the key.

Note: Make sure your vehicle is locked before leaving it unattended.

Note: If you are in range, the remote control will operate if you press any button unintentionally.

Note: The remote control contains sensitive electrical components. Exposure to moisture or impact may cause permanent damage.

REMOTE CONTROL - VEHICLES WITH: KEYLESS ENTRY

Passive Key



E266840

The key must be in your vehicle to switch the ignition on and start the engine.

Removable Key Blade

The passive key also contains a removable key blade that you can use to unlock your vehicle.



E87964

1. Press and hold the buttons on the edges of the transmitter to release the cover. Carefully remove the cover.
2. Remove the key blade from the transmitter.

Keys and Remote Controls

Changing the Remote Control Battery

WARNING: Keep batteries away from children to prevent ingestion. Failure to follow this instruction could result in personal injury or death. If ingested, immediately seek medical attention.

WARNING: If the battery compartment does not securely close, stop using the remote control and replace it as soon as possible. In the meantime, keep the remote control away from children. Failure to follow this instruction could result in personal injury or death.



Make sure that you dispose of old batteries in an environmentally friendly way. Seek advice from your local authority about recycling old batteries.

The remote control uses one coin-type three-volt lithium battery CR2032 or equivalent.

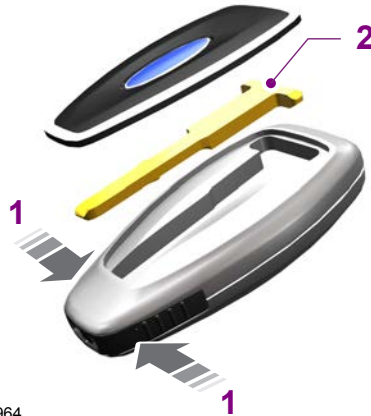

E87964

1. Press and hold the buttons on the edges of the transmitter to release the cover. Carefully remove the cover.
2. Remove the key blade from the transmitter.

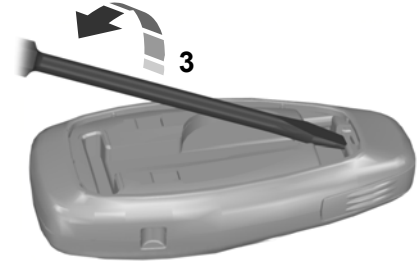

E105362

3. Use a suitable tool, for example a screwdriver, to carefully separate the two halves of the remote control.

Keys and Remote Controls



E119190

4. Twist the screwdriver in the position shown to separate the two halves of the remote control.

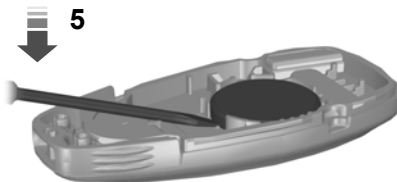

E125860

5. Carefully remove the battery with the screwdriver.

Note: Do not touch the battery contacts or the printed circuit board with the screwdriver.

6. Insert a new battery with the + facing downward.

Note: Do not wipe off any grease on the battery terminals or on the back surface of the circuit board.

7. Assemble the two halves of the remote control.
8. Reinstall the key blade.

Locating Your Vehicle

Press the lock button on the key twice within three seconds. The direction indicators will flash.

Remote Control Information Messages

Message	Action
Key battery low Replace soon	Displays when the remote control battery requires replacing.

Keys and Remote Controls

REMOTE CONTROL - VEHICLES WITH: REMOTE FLIP KEY

Use the key blade to start your vehicle and unlock or lock the driver door from outside your vehicle. The buttons on the key operate the remote control function.



E186181

Changing the Remote Control Battery

WARNING: Keep batteries away from children to prevent ingestion. Failure to follow this instruction could result in personal injury or death. If ingested, immediately seek medical attention.

WARNING: If the battery compartment does not securely close, stop using the remote control and replace it as soon as possible. In the meantime, keep the remote control away from children. Failure to follow this instruction could result in personal injury or death.

 Make sure that you dispose of old batteries in an environmentally friendly way. Seek advice from your local authority about recycling old batteries.

The remote control uses one coin-type three-volt lithium battery CR2032 or equivalent.



E248483

1. Press the release button.



E248514

2. Insert a suitable tool, for example a screwdriver, in the position shown and gently push the clip.
3. Press the clip down to release the battery cover.

Keys and Remote Controls

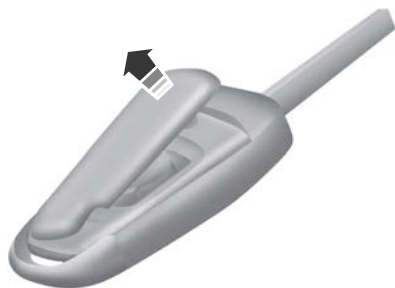

4. Carefully remove the cover.



5. Insert a screwdriver in the position shown to release the battery.

Note: Do not touch the battery contacts or the printed circuit board with the screwdriver.

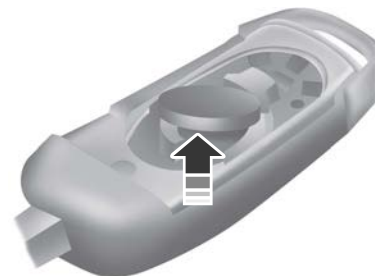

6. Remove the battery.

7. Insert a new battery with the + facing upward.

Note: Do not wipe off any grease on the battery terminals or on the back surface of the circuit board.

8. Reinstall the battery cover.

Locating Your Vehicle

Press the lock button on the key twice within three seconds. The direction indicators will flash.

Keys and Remote Controls

Remote Control Information Messages

Message	Action
Key battery low Replace soon	Displays when the remote control battery requires replacing.

REPLACING A LOST KEY OR REMOTE CONTROL

You can purchase replacement keys or remote controls from an authorized dealer. Authorized dealers can program remote controls for your vehicle.

To re-program the passive anti-theft system see an authorized dealer.

PASSIVE KEY BACKUP POSITION

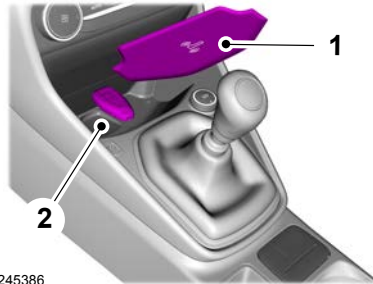

E245386

1. Remove the rubber mat.
2. Place the passive key in the position shown, with the buttons facing upward.

WHAT IS MYKEY

MyKey allows you to program keys with restricted settings to promote good driving habits.

MYKEY SETTINGS

Non-Configurable MyKey Settings

Seatbelt Reminder

The audio system mutes when the seatbelt reminder turns on. The seatbelt reminder cannot be switched off with a MyKey.

Early Low Fuel

The low fuel level warning lamp turns on earlier.

Driving and Parking Aids

Parking aids, blind spot information system and cross traffic alert turn on when you start the engine and cannot be switched off with a MyKey.

Pre-collision assist and lane keeping alert turn on when you start the engine, but can be switched off with a MyKey.

A new destination in the navigation system can only be set using voice commands, when using a MyKey and your vehicle is moving.

Configurable MyKey Settings

You can configure the following settings after creating a MyKey. See **Creating a MyKey** (page 60).

Speed Limit

 **WARNING:** Do not set MyKey maximum speed limit to a limit that will prevent the driver from maintaining a safe speed considering posted speed limits and prevailing road conditions. The driver is always responsible to drive in accordance with local laws and prevailing conditions. Failure to do so could result in accident or injury.

You can set a speed limit for your vehicle. Warning messages appear in the information display and a tone sounds if your vehicle reaches the set speed. You cannot override the set speed when using a MyKey.

Speed Reminder

You can set a speed reminder for your vehicle. Warning messages appear in the information display and a tone sounds if your vehicle exceeds the set speed.

Audio System Volume Limit

The audio system maximum volume is reduced. A message appears in the information display if you attempt to exceed the volume limit. Automatic volume control turns off.

Emergency Assistance

If you set emergency assistance to be always on, it cannot be switched off with a MyKey.

Do Not Disturb

If you set do not disturb to be always on, it cannot be switched off with a MyKey.

Traction Control

If you set traction control to be always on, it cannot be switched off with a MyKey.

MyKey™

CREATING A MYKEY - VEHICLES WITHOUT: PUSH BUTTON START

1. Switch the ignition on using an admin key.
2. Using the information display controls on the steering wheel, select **Settings**.
3. Select **MyKey**.
4. Select **Create MyKey**.
5. Press and hold the **OK** button until a confirmation message appears in the information display.
6. Switch the ignition off.

Note: We recommend that you label this key.

CREATING A MYKEY - VEHICLES WITH: PUSH BUTTON START

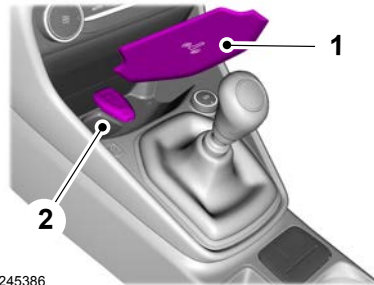

E245386

1. Remove the rubber mat.
2. Place the admin key in the position shown, with the buttons facing upward.
3. Switch the ignition on.
4. Using the information display controls on the steering wheel, select **Settings**.
5. Select **MyKey**.
6. Select **Create MyKey**.
7. Press and hold the **OK** button until a confirmation message appears in the information display.
8. Switch the ignition off.

Note: We recommend that you label this key.

PROGRAMMING A MYKEY

You can only program MyKeys to the same settings.

1. Switch the ignition on using an admin key.
2. Using the information display controls on the steering wheel, select **Settings**.
3. Select **MyKey**.
4. Select a setting and press the **OK** button.
5. Configure the setting.
6. Switch the ignition off.

CLEARING ALL MYKEYS

When you clear all MyKeys, you remove all restrictions and return all MyKeys to their original admin key status.

1. Switch the ignition on using an admin key.
2. Using the information display controls on the steering wheel, select **Settings**.
3. Select **MyKey**.
4. Select **Clear MyKeys**.

MyKey™

5. Press and hold the **OK** button until a confirmation message appears in the information display.

CHECKING MYKEY SYSTEM STATUS

You can find information about the distance traveled using a MyKey and also the number of admin keys and MyKeys created for your vehicle.

1. Switch the ignition on.
2. Using the information display controls on the steering wheel, select **Settings**.

3. Select **MyKey**.
4. Select **MyKey info**.

USING MYKEY WITH REMOTE START SYSTEMS

The system is not compatible with non-Ford remote start systems.

MYKEY – TROUBLESHOOTING

MyKey – Information Messages - Vehicles Without: Push Button Start

Message	Description
Key is already a MyKey	Displays when trying to create a MyKey with a key already designated as a MyKey.
Key restricted at next start. Label this key	Displays to confirm that the key is restricted after you switch the ignition off.

MyKey™

MyKey – Information Messages - Vehicles With: Push Button Start

Message	Description
Place key in backup location	Displays when trying to create a MyKey and the admin key is not placed in the backup position. See Creating a MyKey (page 60).
Key is already a MyKey	Displays when trying to create a MyKey with a key already designated as a MyKey.
Key restricted at next start. Label this key	Displays to confirm that the key is restricted after you switch the ignition off.

MyKey – Frequently Asked Questions - Vehicles Without: Push Button Start

What is an admin key?

- An admin key is a key that has not been created as a MyKey. See **Creating a MyKey** (page 60).

Why can I not create a MyKey?

- The key used to switch the ignition on is not an admin key.
- The key used to switch the ignition on is the only admin key. There always has to be at least one admin key.

Why can I not program a MyKey?

- The key used to switch the ignition on is not an admin key.
- No MyKeys are created. See **Creating a MyKey** (page 60).

Why can I not clear the MyKeys?

- The key used to switch the ignition on is not an admin key.
- No MyKeys are created. See **Creating a MyKey** (page 60).

Why does the MyKey distance not accumulate?

- The key used to start the engine is an admin key.
- No MyKeys are created. See **Creating a MyKey** (page 60).
- The MyKeys have been cleared.

MyKey – Frequently Asked Questions - Vehicles With: Push Button Start

What is an admin key?

- An admin key is a key that has not been created as a MyKey. See **Creating a MyKey** (page 60).

Why can I not create a MyKey?

- The admin key is not placed in the backup position. See **Creating a MyKey** (page 60).
- The key used to switch the ignition on is not an admin key.
- The key used to switch the ignition on is the only admin key. There always has to be at least one admin key.
- The last MyKey was created without switching the ignition off.

Why can I not program a MyKey?

- The admin key is not inside your vehicle.
- The key used to switch the ignition on is not an admin key.
- No MyKeys are created. See **Creating a MyKey** (page 60).

Why can I not clear the MyKeys?

- The admin key is not inside your vehicle.
- The key used to switch the ignition on is not an admin key.
- No MyKeys are created. See **Creating a MyKey** (page 60).

Why does the MyKey distance not accumulate?

- The key used to start the engine is an admin key.
- An admin key and a MyKey are inside your vehicle.
- No MyKeys are created. See **Creating a MyKey** (page 60).
- The MyKeys have been cleared.

Why can I not start the engine with a MyKey?

- An admin key and a MyKey are inside your vehicle.

Doors and Locks

OPERATING THE DOORS FROM OUTSIDE YOUR VEHICLE

Unlocking and Locking the Doors Using the Remote Control

You can only use the remote control when your vehicle is stationary.

Unlocking the Doors



Press the button to unlock all doors.

Locking the Doors



Press the button to lock all doors. One short flash of the turn signal lamps confirms that your vehicle has locked.

Note: For more information on operating the doors from outside your vehicle See **Keyless Entry** (page 71).

Unlocking and Locking the Doors Using the Key Blade

Removing the Lock Cylinder Cap

1. Release the key blade from the remote control. See **Remote Control** (page 53).

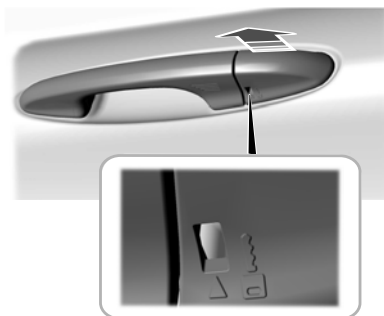

E243949

2. Fully insert the key blade into the key slot.
3. Gently pull the lock cylinder cap toward you to release it.
4. Insert the key blade into the lock cylinder.

Locking the Doors

Turn the top of the key toward the front of your vehicle.

Unlocking the Driver Door

Turn the top of the key toward the rear of your vehicle.

Note: If the child safety locks are on and you pull the interior handle, you only switch off the emergency locking, not the child safety lock. You can only open the doors using the external door handle.

Reinstalling the Lock Cylinder Cap

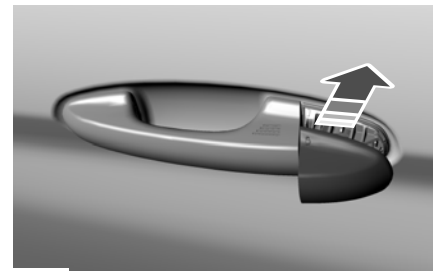

E244050

1. Place the cap over the lock cylinder.

Doors and Locks

2. Push the cap forward until it clicks into place. Make sure you have properly installed the cap by trying to move it rearward.

Double Locking the Doors Using the Remote Control

 **WARNING:** Do not use double locking when passengers or animals are inside your vehicle. The doors cannot be unlocked or opened from the inside when double locked.

Double locking is a theft protection feature that prevents someone from opening the doors from the inside. You can only double lock the doors if all the doors are closed.



Press the button twice within three seconds. Three short flashes of the direction indicators confirm that your vehicle has double locked.

Double Locking the Doors Using the Key Blade

 **WARNING:** Do not use double locking when passengers or animals are inside your vehicle. The doors cannot be unlocked or opened from the inside when double locked.

Double locking is a theft protection feature that prevents someone from opening the doors from the inside. You can only double lock the doors if all the doors are closed.

1. Remove the lock cylinder cap. See **Unlocking and Locking the Doors Using the Key Blade** (page 65).
2. Turn the top of the key toward the front of your vehicle twice within three seconds.
3. Reinstall the lock cylinder cap.

Individually Unlocking and Locking the Doors Using the Key Blade

Locking the Doors

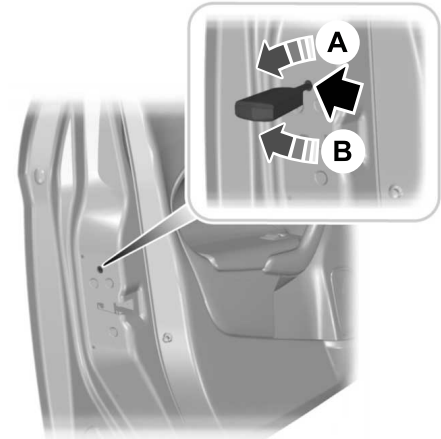

If the central locking function does not operate, individually lock the doors using the key in the position shown.

Left-Hand Side

Turn counterclockwise to lock.

Doors and Locks

Right-Hand Side

Turn clockwise to lock.

Unlocking the Doors

If the central locking function does not operate, unlock the driver door and then individually unlock all other doors by pulling the interior door handles.

Note: *When the doors have been unlocked using this method, the doors must be individually locked until the central locking function has been repaired.*

OPERATING THE DOORS FROM INSIDE YOUR VEHICLE

Unlocking and Locking the Doors Using the Central Locking

The power door lock control is on the driver door.



Press the button to unlock all doors.



Press the button to lock all doors.

Note: *The central locking only operates if the front doors are fully closed.*

REPROGRAMMING THE UNLOCKING FUNCTION

You can program the unlocking function so that only the driver door unlocks.

Press and hold the unlock and lock buttons on the remote control simultaneously for at least four seconds with the ignition off. The direction indicators flash twice to confirm the change.

To return to the original unlocking function, repeat the process.

If you program the unlocking function so that only the driver door unlocks, the following occurs:

- If you unlock the driver door first, all other doors remain locked. You can unlock all of the other doors from inside your vehicle using the power door lock control on the driver door. Doors can be individually unlocked by pulling the interior door handles on those doors.
- If you press the unlocking button on the remote control once, only the driver door unlocks. Press the unlocking button on the remote control twice within three seconds to unlock all doors.
- If you unlock any other door first, all other doors and the liftgate unlock.

You can also change between the unlocking modes in the information display.

1. Using the information display controls on the steering wheel, select **Settings**.
2. Select **Vehicle settings**.
3. Select **Locks**.
4. Select **Unlocking**.
5. Select **All doors** or **Driver's door**.

Doors and Locks

DOOR LOCK SWITCH INHIBITOR

How Does the Door Lock Switch Inhibitor Work

The door lock switch inhibitor is a theft protection feature that prevents someone unlocking the vehicle from inside using the power door lock control switch.

When you lock your vehicle with the remote control, the power door lock control switch does no longer operate after 20 seconds.

Note: You must unlock your vehicle with the remote control, or switch the ignition on, to restore the power door lock control switch function.

AUTOUNLOCK

What Is Autounlock

Autounlock is an unlocking feature that unlocks the vehicle doors when your vehicle comes to a stop.

Autounlock Requirements

Autounlock unlocks all the doors when all of the following occur:

- The ignition is on, all the doors are closed and your vehicle is moving at a speed greater than 20 km/h (12 mph).
- Your vehicle comes to a stop.
- You open the driver door within 10 minutes of switching the ignition off or to the accessory position.

Switching Autounlock On and Off

1. Using the information display controls on the steering wheel, select **Settings**.
2. Select **Vehicle settings**.
3. Select **Locks**.
4. Switch **Auto unlock** on or off.

AUTOLOCK

What Is Autolock

Autolock is a locking feature that locks the vehicle doors when you start driving.

Autolock Requirements

Autolock locks all the doors when all of the following occur:

- All doors are closed.
- The ignition is on.
- Your vehicle reaches a speed greater than 20 km/h (12 mph).

Switching Autolock On and Off

1. Using the information display controls on the steering wheel, select **Settings**.
2. Select **Vehicle settings**.
3. Select **Locks**.
4. Switch **Auto lock** on or off.

MISLOCK

What Is Mislock

Mislock is a locking feature that warns you if your vehicle has not locked.

Doors and Locks

How Does Mislock Work

The horn sounds when you press the lock button on the remote control twice within three seconds and a door is open.

Mislock Limitations - Vehicles Without: Anti-Theft Alarm

When you press the lock button once, the direction indicators do not flash if any door or the liftgate is open.

If you switch mislock off, the horn does not sound if you press the lock button on the remote control when a door is open.

Mislock Limitations - Vehicles With: Anti-Theft Alarm

When you press the lock button once, the direction indicators do not flash if:

- Any door or the liftgate is open.
- The hood is open.

If you switch mislock off, the horn does not sound if you press the lock button on the remote control when a door is open.

Switching Mislock On and Off

1. Using the information display controls on the steering wheel, select **Settings**.
2. Select **Vehicle settings**.
3. Select **Locks**.
4. Switch **Mislock chirp** on or off.

AUTORELOCK

How Does Autorelock Work

The doors automatically relock if you do not open a door within 45 seconds of unlocking the doors with the remote control. The door locks and the alarm return to their previous state.

DOOR LOCK INDICATORS

An LED on the power door lock control illuminates when you lock the door. It remains on for up to five minutes after you switch the ignition off.

DOORS AND LOCKS AUDIBLE WARNINGS

Door Ajar Audible Warning

Sounds when a door is not fully closed and your vehicle is moving.

DOORS AND LOCKS – TROUBLESHOOTING

Doors and Locks – Warning Lamps

Door Ajar Warning Lamp



It illuminates when you switch the ignition on and remains on if any door or the hood is open.

Doors and Locks

Doors and Locks – Information Messages

Message	Action
Driver door open	Displays if a door is open. Fully close the door.
Passenger door open	
Rear left door open	
Rear right door open	

Keyless Entry

KEYLESS ENTRY LIMITATIONS

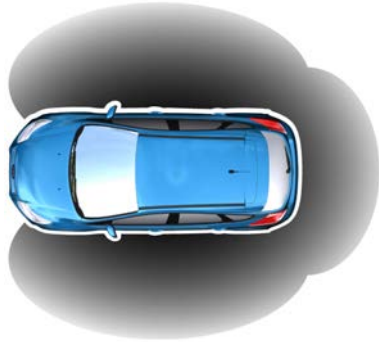

E78276

A valid passive key must be within one of the three external detection ranges. These are approximately 1.5 m (5 ft) from the front door handles and the liftgate.

The system could not function if:

- The passive key remains stationary for about a minute.
- The vehicle battery has no charge.
- The passive key battery has no charge.

- The passive key frequencies are jammed.
- The passive key is too close to metal objects or electronic devices, for example keys or a cell phone.

KEYLESS ENTRY SETTINGS

Switching Keyless Entry On and Off

1. Using the information display controls on the steering wheel, select **Settings**.
2. Select **Vehicle settings**.
3. Select **Locks**.
4. Switch **KeyFree** on and off.

Reprogramming the Unlocking Function

You can program the unlocking function so that only the driver door unlocks when you touch the unlock sensor on the exterior door handle.

If you program the unlocking function so that only the driver door unlocks, the following occurs:

- If you open the driver door first, all other doors remain locked. You can unlock all of the other doors from inside your vehicle using the power door lock control on the driver door. You can unlock individual doors by pulling the interior door handles on those doors.
- If you open any other door first, all other doors and the liftgate unlock.

You can change between the unlocking modes in the information display.

1. Using the information display controls on the steering wheel, select **Settings**.
2. Select **Vehicle settings**.
3. Select **Locks**.
4. Select **Unlocking**.
5. Select **All doors** or **Driver's door**.

Keyless Entry

LOCKING AND UNLOCKING THE DOORS USING KEYLESS ENTRY

Unlocking the Doors

Unlock sensors are on the back of the exterior front door handles.



Touch the unlock sensor to unlock your vehicle and disarm the alarm. The direction indicators flash. Do not touch the lock sensor on the top of the door handle.

Keep the door handle clean to make sure the system correctly operates.

After unlocking the doors with the unlock sensor, there is a brief delay before you can lock your vehicle. When the delay period is over, you can lock the doors again, provided the passive key is within the respective detection range.

Locking the Doors

Lock sensors are on the top of the exterior front door handles.



Touch a lock sensor once to lock your vehicle and arm the alarm. The direction indicators flash.

Keep the door handle clean to make sure the system correctly operates.

Note: *Your vehicle does not automatically lock. If you do not touch a lock sensor your vehicle remains unlocked.*

After locking the doors with the lock sensor, there is a brief delay before you can unlock your vehicle. This delay lets you pull the handle to make sure your vehicle is locked. When the delay period is over, you can unlock the doors again, provided the passive key is within the respective detection range.

Double Locking the Doors

Touch a lock sensor twice within three seconds to double lock your vehicle and arm the alarm. The direction indicators flash. Do not touch the unlock sensor on the back of the door handle.

LOCKING AND UNLOCKING THE LIFTGATE USING KEYLESS ENTRY

Unlocking the Liftgate



E190028

Press the exterior release button hidden above the license plate.

Note: *A valid passive key must be within the detection range.*

Keyless Entry

Locking the Liftgate

The liftgate locks after you fully close it.

KEYLESS ENTRY – TROUBLESHOOTING

Keyless Entry – Frequently Asked Questions

Why does the keyless entry system not function?

If the system does not function it may be limited. See **Keyless Entry Limitations** (page 71). If the system still does not function use the remote control or the key blade to lock and unlock your vehicle.

Why can I not lock my vehicle?

If you electronically lock your vehicle with a rear door or the liftgate open, the system searches for a passive key inside your vehicle after you close the last door. If the system detects a key, all doors unlock indicating that a key is inside. Your vehicle locks if another passive key is within the detection range after you close the last door.

Why does the passive key not work?

The system deactivates passive keys left inside your vehicle when you lock it. You cannot switch the ignition on using a deactivated passive key. Press the unlock button on the remote control to reactivate a passive key.

Liftgate

MANUAL LIFTGATE

 **WARNING:** It is extremely dangerous to ride in a cargo area, inside or outside of a vehicle. In a crash, people riding in these areas are more likely to be seriously injured or killed. Do not allow people to ride in any area of your vehicle that is not equipped with seats and seatbelts. Make sure everyone in your vehicle is in a seat and properly using a seatbelt. Failure to follow this warning could result in serious personal injury or death.

 **WARNING:** Make sure to close and latch the liftgate to prevent drawing exhaust fumes into your vehicle. This will also prevent passengers and cargo from falling out. If you must drive with the liftgate open, keep the vents or windows open so outside air comes into your vehicle. Failure to follow this warning could result in serious personal injury.

Note: Be careful when opening or closing the liftgate in a garage or other enclosed area to avoid damaging the liftgate.

Note: Do not hang anything, for example a bike rack, from the glass or liftgate. This could damage the liftgate and its components.

Note: Do not leave the liftgate open when you are driving. This could damage the liftgate and its components.

Opening the Liftgate Using the Exterior Release Button



E190028

Press the exterior release button.

Opening the Liftgate Using the Remote Control



Press the button twice within three seconds.

Closing the Liftgate

A recessed grip or handle is inside the liftgate to help with closing.

Security

PASSIVE ANTI-THEFT SYSTEM

Principle of Operation

The system prevents someone from starting the engine with an incorrectly coded key.

Note: *Always take your keys and lock all doors when leaving your vehicle.*

Coded Keys

If you lose a key, you can obtain a replacement from an authorized dealer. If possible, provide them with the key number from the tag provided with the original keys. You can also obtain extra keys from an authorized dealer.

Note: *Have all of your remaining keys erased and recoded if you lose a key. Have replacement keys coded together with recoding your remaining keys. Ask an authorized dealer for more information.*

Note: *Metallic objects, electronic devices or a second coded key on the same key chain may result in vehicle starting problems, especially if they are too close to the key when starting your vehicle.*

Arming the Engine Immobilizer

The engine immobilizer arms after a short period of time when you switch the ignition off.

Disarming the Engine Immobilizer

The engine immobilizer disarms when you switch the ignition on with a correctly coded key.

If you are unable to start your vehicle with a correctly coded key, have your vehicle checked by an authorized dealer.

ANTI-THEFT ALARM- VEHICLES WITH: INTEGRAL BATTERY

Perimeter Alarm

The perimeter alarm is a deterrent against unauthorized access to your vehicle through the doors and the hood.

Interior Sensors

The interior sensors are in the overhead console.

When you lock your vehicle and arm the alarm, the sensors are designed to detect any movement inside your vehicle.

Note: *Do not cover the interior sensors.*

Inclination Sensors

When you lock your vehicle and arm the alarm, the sensors are designed to detect an attempt to raise your vehicle, for example to remove a wheel or to tow it away.

Battery Back-up Sounder (If Equipped)

The battery back-up sounder is an additional alarm component that has its own battery and sounds a siren if the vehicle battery or the battery back-up sounder is disconnected. The system arms when you lock your vehicle and the ignition is off.

Triggering the Alarm

When armed, the alarm is triggered in any of the following ways:

- If someone opens a door, the liftgate or the hood without a valid key or remote control.
- If you switch your vehicle on without a correctly coded key.
- If the interior sensors detect movement inside your vehicle.

Security

- If the inclination sensors detect an attempt to raise your vehicle.
- If someone disconnects the vehicle battery or the battery back-up sounder.

If the alarm is triggered, the alarm horn sounds for 30 seconds and the hazard flasher flashes for 5 minutes.

Any further attempts to carry out one of the above sounds the alarm again.

Full and Reduced Guard

Full Guard

Full guard is the standard setting.

In full guard, the interior sensors are on when you arm the alarm.

Note: *Do not arm the alarm with full guard if passengers, animals or other moving objects are inside your vehicle.*

Reduced Guard

In reduced guard, the inclination and interior sensors are off when you arm the alarm.

Selecting Full or Reduced Guard

You can select full or reduced guard using the information display. See **General Information** (page 116).

Ask on Exit (If Equipped)

You can set the information display to ask you each time which level of guard you wish to set. See **General Information** (page 116).

Arming the Alarm

The alarm arms when you lock your vehicle and the ignition is off. See **Doors and Locks** (page 65).

Disarming the Alarm

Vehicles Without Keyless Entry

Disarm and silence the alarm by unlocking the doors with the key and switching your vehicle on with a correctly coded key, or by unlocking the doors with the remote control.

Vehicles with Keyless Entry

Perimeter Alarm

Disarm and silence the alarm by unlocking the doors and switching your vehicle on, or by unlocking the doors with the remote control.

Note: *A valid passive key must be within the detection range of that door. See **Keyless Entry Limitations** (page 71).*

Category One Alarm

Disarm and silence the alarm by unlocking the doors and switching your vehicle on, or by unlocking the doors or the liftgate with the remote control.

Note: *A valid passive key must be within the detection range of that door. See **Keyless Entry Limitations** (page 71).*

ANTI-THEFT ALARM - VEHICLES WITH: PERIMETER ALARM

The perimeter alarm is a deterrent against unauthorized access to your vehicle through the doors and the hood. If the alarm is triggered, the alarm horn sounds and the hazard flasher flashes.

Take all remote controls to an authorized dealer if there is any potential alarm problem with your vehicle.

Arming the Alarm

The alarm arms when you lock your vehicle. See **Doors and Locks** (page 65).

Disarming the Alarm

Vehicles Without Keyless Entry

Disarm and silence the alarm by unlocking the doors with the key and switching your vehicle on with a correctly coded key, or by unlocking the doors with the remote control.

Vehicles With Keyless Entry

Disarm and silence the alarm by unlocking the doors and switching your vehicle on, or by unlocking the doors with the remote control.

Note: *A valid passive key must be within the detection range of that door. See **Keyless Entry Limitations** (page 71).*

Door Edge Protection (If Equipped)

PRINCIPLE OF OPERATION

The front and rear doors have a retractable plastic door edge protector that moves into position when you open a door. The door edge protector protects the door edge from damage that could be caused by contact with other objects.

Do not attempt to move the door edge protector if it becomes stuck, or does not move freely. Have your vehicle checked as soon as possible.

Note: *The door edge protector may be moved gently out of position when the door is open to allow access for cleaning. Make sure that the door edge protector is repositioned correctly otherwise it may not retract when you attempt to close the door.*

Note: *Keep the door edges free from snow, ice and large accumulations of dirt.*

Steering Wheel

ADJUSTING THE STEERING WHEEL

 **WARNING:** Do not adjust the steering wheel when your vehicle is moving.

Note: Make sure that you are sitting in the correct position. See **Sitting in the Correct Position** (page 145).



E95178

1. Unlock the steering column.

2. Adjust the steering wheel to the desired position.



E95179

3. Lock the steering column.

LOCKING THE STEERING WHEEL - VEHICLES WITHOUT: PUSH BUTTON START

1. Remove the key from the ignition.

2. Slightly rotate the steering wheel to engage the lock.

Unlocking the Steering Wheel

 **WARNING:** Always check that the steering is unlocked before attempting to move your vehicle.

1. Insert the key in the ignition.
2. Turn the key to position **I**.

Note: You may have to slightly rotate the steering wheel to assist unlocking it.

LOCKING THE STEERING WHEEL - VEHICLES WITH: PUSH BUTTON START

The steering wheel lock locks shortly after you have parked your vehicle and the passive key is outside it.

Note: The steering wheel lock does not lock when the ignition is on or when your vehicle is moving.

Steering Wheel

Unlocking the Steering Wheel

The steering wheel lock unlocks when the system detects a valid passive key inside your vehicle. If the steering wheel lock relocks, switch the ignition on to unlock it.

Note: *You may have to slightly rotate the steering wheel to assist unlocking it.*

HEATED STEERING WHEEL

The heated steering wheel button is on the climate controls.



Press the button to switch the heated steering wheel on and off.

Note: *You can use the heated steering wheel only when the engine is running.*

Note: *The system uses a sensor and is designed to control the temperature of the steering wheel and to prevent it from overheating.*

Note: *In warm temperatures, the steering wheel quickly reaches its maximum temperature and the system reduces the current to the heating element. This could cause you to think that the system has stopped working but it has not. This is normal.*

Wipers

WIPER PRECAUTIONS

Fully defrost the windshield before you switch the windshield wipers on.

Do not operate the wipers on a dry windshield. This may scratch the glass or damage the wiper blades. Always use the windshield washers before wiping a dry windshield.

Make sure that you switch the windshield wipers off before entering a car wash.

Make sure that you switch the rear window wiper off before entering a car wash.

Keep the outside of the windshield clean. The rain sensor is very sensitive and the wipers may operate if dirt, mist or insects hit the windshield.

SWITCHING WINDSHIELD WIPERS ON AND OFF

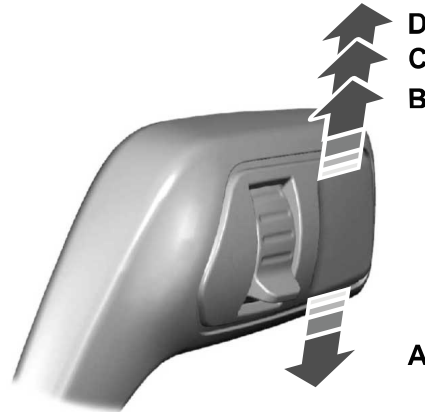

- A Single wipe.
- B Intermittent wipe.

- C Normal wipe.
- D High-speed wipe.

INTERMITTENT WIPE

Switching Intermittent Wipe On and Off



Wipers

Setting the Intermittent Wipe Interval

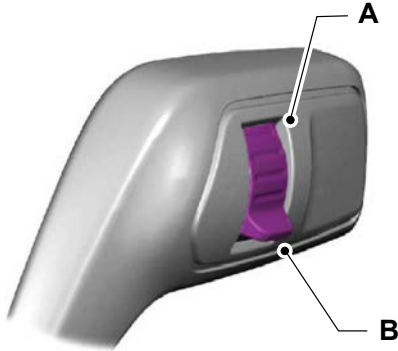

- A Short interval.
- B Long wipe interval.

Use the rotary control to adjust the intermittent wipe interval.

AUTOWIPERS

What Is Autowipers

Autowipers turns on and controls the speed and frequency of the windshield wipers.

Autowiper Settings

1. Using the information display controls on the steering wheel, select **Settings**.
2. Select **Vehicle settings**.
3. Select **Wipers**.
4. Select **Rain sensing**.

Note: If you switch autowipers off in the information display, the windshield wipers operate in intermittent mode.

Switching Autowipers On and Off



Wipers

Adjusting the Sensitivity of the Rain Sensor

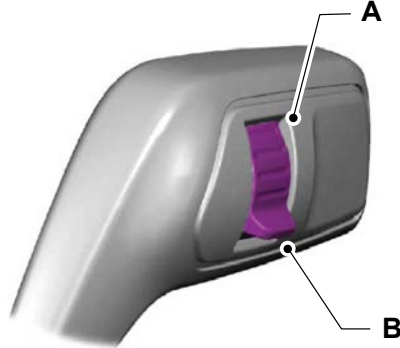

- A High sensitivity.
- B Low sensitivity.

Use the rotary control to adjust the sensitivity of autowipers.

Note: When you select low sensitivity, the wipers operate when the sensor detects a large amount of water on the windshield. When you select high sensitivity, the wipers operate when the sensor detects a small amount of water on the windshield.

SWITCHING THE REAR WINDOW WIPER ON AND OFF

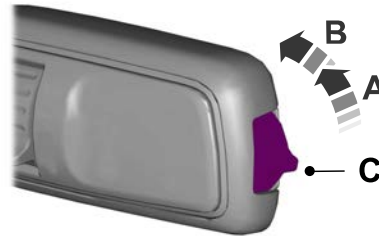

- A Intermittent wipe.
- B Continuous wipe.
- C Rear window wiper off.

SWITCHING REVERSE WIPE ON AND OFF

1. Using the information display controls on the steering wheel, select **Settings**.
2. Select **Vehicle settings**.
3. Select **Wipers**.
4. Select **Reverse wiper**.

Note: The rear window wiper turns on when you shift into reverse and the windshield wipers are on.

CHECKING THE WIPER BLADES



Run the tip of your fingers over the edge of the blade to check for roughness.

Wipers

REPLACING THE FRONT WIPER BLADES

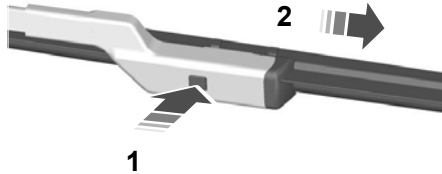

E72899

1. Lift the wiper arm and then press the wiper blade locking button.

Note: Do not hold the wiper blade to lift the wiper arm.

2. Remove the wiper blade.

Note: Make sure that the wiper arm does not spring back against the glass when the wiper blade is not attached.

3. To install, reverse the removal procedure.

Note: Make sure that the wiper blade locks into place.

REPLACING THE REAR WIPER BLADES

1. Lift the wiper arm.

Note: Do not hold the wiper blade to lift the wiper arm.

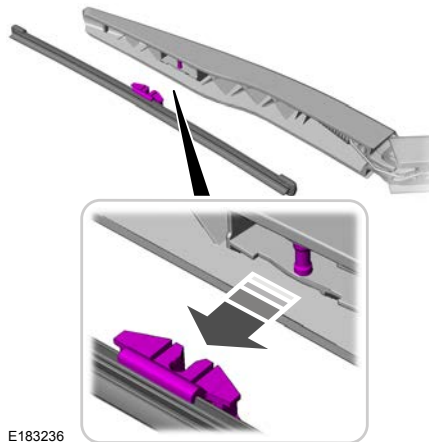

E183236

2. Disengage the wiper blade from the wiper arm.

Note: Make sure that the wiper arm does not spring back against the glass when the wiper blade is not attached.

3. To install, reverse the removal procedure.

Note: Make sure that the wiper blade locks into place.

WIPERS – TROUBLESHOOTING

Wipers – Frequently Asked Questions

Why are there streaks and smears on the windshield?

The wiper blades could be dirty, worn or damaged. Check the wiper blades. See **Checking the Wiper Blades** (page 83).

If the wiper blades are dirty, clean them. If the wiper blades are worn or damaged, install new ones. See **Replacing the Front Wiper Blades** (page 84).

Washers

WASHER PRECAUTIONS

Do not operate the washers when the washer reservoir is empty. This could cause the washer pump to overheat.

WASHING THE WINDSHIELD



Note: When you release the lever, the wipers operate for a short time.

Note: A courtesy wipe occurs a short time after the wipers stop to clear any remaining washer fluid. See **Switching the Courtesy Wipe On and Off** (page 85).

SWITCHING THE COURTESY WIPE ON AND OFF

1. Using the information display controls on the steering wheel, select **Settings**.
2. Select **Vehicle settings**.
3. Select **Wipers**.
4. Select **Courtesy wipe**.

WASHING THE REAR WINDOW



Note: When you release the lever, the wipers operate for a short time.

Washers

LOCATING THE WASHER FLUID RESERVOIR

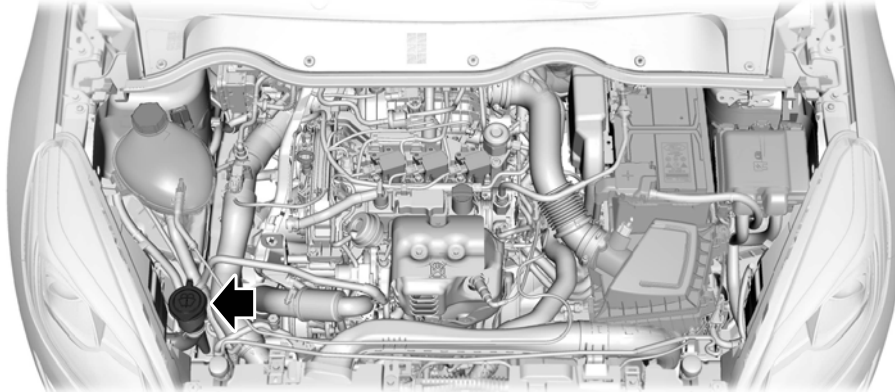

ADDING WASHER FLUID

1. Remove the washer fluid reservoir cap.

2. Add washer fluid that meets our specification. See **Washer Fluid Specification** (page 87).

3. Install the washer fluid reservoir cap.

Note: *The reservoir supplies the front and rear washer systems.*

WASHER FLUID RESERVOIR CAPACITY

3 L (0.7 gal)

Washers

WASHER FLUID SPECIFICATION

Materials

Name	Specification
Screen Wash FU7J-19C544-AA/BA/DA/EA/GA/HA	WSS-M14P19-A

Lighting

GENERAL INFORMATION

Condensation in the Exterior Front Lamps and Rear Lamps

Exterior front lamps and rear lamps have vents to accommodate normal changes in air pressure.

Condensation can be a natural by-product of this design. When moist air enters the lamp assembly through the vents, there is a possibility that condensation can occur when the temperature is cold. When normal condensation occurs, a fine mist can form on the interior of the lens. The fine mist eventually clears and exits through the vents during normal operation.

Clearing time may take as long as 48 hours under dry weather conditions.

Examples of acceptable condensation are:

- The presence of a fine mist (no streaks, drip marks or large droplets).
- A fine mist covers less than 50% of the lens.

Examples of unacceptable condensation are:

- A water puddle inside the lamp.
- Streaks, drip marks or large droplets present on the interior of the lens.

If you see any unacceptable condensation, have your vehicle checked by an authorized dealer.

LIGHTING CONTROL

Lighting Control Positions

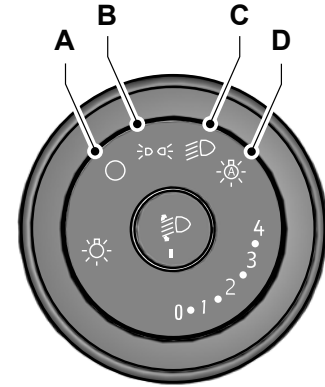

- A Lamps off.
- B Parking lamps, instrument panel lamps and license plate lamps.

Lighting

- C Headlamps.
- D Autolamps. See **Autolamps** (page 91).

Switching All of the Parking Lamps On

1. Switch the ignition off.
2. Set the lighting control to the parking lamps position.

Note: *Parking lamps could turn off to prevent the vehicle battery from running out of charge.*

Switching the Left-Hand Side or the Right-Hand Side Parking Lamps On (If Equipped)

1. Switch the ignition off.



2. Push the lever up or down to switch the parking lamps on.

Note: *Parking lamps could turn off to prevent the vehicle battery from running out of charge.*

Switching High Beam Headlamps On and Off



Push the lever away from you to switch the high beam headlamps on.

Push the lever forward again or pull the lever toward you to switch the high beam headlamps off.

Note: *If you switch the autolamps on, you cannot switch the high beam headlamps on until the system turns the headlamps on.*

Lighting

Flashing High Beam Headlamps



E248604

Pull the lever toward you and release it to flash the high beam headlamps.

High Beam Headlamp Indicator



It illuminates when you switch the high beam headlamps on.

Lamps On Indicator



It illuminates when you switch the low beam headlamps or the side and rear lamps on.

Low Beam Headlamp Warning Lamp

(If Equipped)



If it illuminates when the low beam headlamps are on, this indicates that a low beam headlamp bulb has failed.

Exterior Lamps On Audible Warning

Sounds when you open the driver door and the exterior lamps are on.

Headlamps Information Messages

Message	Description
Check adaptive headlamps See manual	Displays if an electrical malfunction occurs with the headlamp system. Have your vehicle checked as soon as possible.

Lighting

AUTOLAMPS



WARNING: The system does not relieve you of your responsibility to drive with due care and attention. You may need to override the system if it does not turn the headlamps on in low visibility conditions, for example daytime fog.

Autolamps turn the headlamps on in low light situations or when the wipers operate.

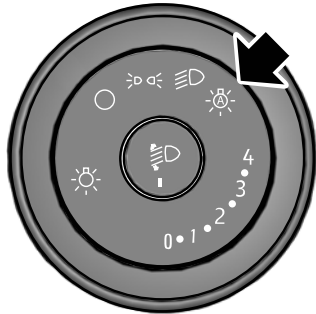

Note: When you switch the autolamps on, the headlamps turn on within 10 seconds of switching the wipers on.

Note: If you switch the autolamps and the autowipers on, the headlamps turn on when the windshield wipers continuously operate.

Note: The headlamps turn off approximately 60 seconds after you switch the wipers off.

The headlamps remain on for a period of time after you switch the ignition off. Use the information display controls to adjust the period of time that the headlamps remain on.

Adjusting the Period of Time That the Headlamps Remain On

1. Using the information display controls on the steering wheel, select **Settings**.
2. Select **Vehicle settings**.
3. Select **Lighting**.
4. Select **Headlamp delay**.
5. Select a setting.
6. Press the **OK** button.

INSTRUMENT LIGHTING DIMMER

The instrument lighting dimmer buttons are on the lighting control.



Repeatedly press one of the buttons to adjust the brightness.





HEADLAMP EXIT DELAY

After you switch the ignition off, you can switch the headlamps on by pulling the direction indicator lever toward you. You will hear a short tone. The headlamps will switch off automatically after three minutes with any door open or 30 seconds after the last door has been closed. You can cancel this feature by pulling the direction indicator lever toward you again or switching the ignition on.

Lighting

AUTOMATIC HIGH BEAM CONTROL

 **WARNING:** The system does not relieve you of your responsibility to drive with due care and attention. You may need to override the system if it does not turn the high beams on or off.

 **WARNING:** You may need to override the system when approaching other road users.

 **WARNING:** You may need to override the system during inclement weather.

 **WARNING:** Do not use the system in poor visibility, for example fog, heavy rain, spray or snow.

 **WARNING:** The system may not switch the high beams off if the lights of oncoming vehicles are hidden by obstacles, for example guard rails.

 **WARNING:** Inspect and replace the windshield wiper blades regularly to make sure the camera sensor has a clear view. The windshield wiper blades must be the correct length.

About Automatic High Beam Control

The system is designed to turn the high beams on if all of the following occur:

- You switched the system on in the information display.
- You set the lighting control to the autolamps position.
- The ambient light level is low enough that high beams are required.

- There is no traffic in front of your vehicle.
- Your vehicle speed is greater than approximately 40 km/h (25 mph).

The system is designed to turn the high beams off if any of the following occur:

- You switch the system off in the information display.
- You set the lighting control to any position except autolamps.
- You switch the rear fog lamps on.
- The ambient light level is high enough that high beams are not required.
- The system detects an approaching vehicle's headlamps or rear lamps.
- The system detects severe rain, snow or fog.
- The system detects street lighting.
- The camera has reduced visibility.
- Your vehicle speed falls below approximately 30 km/h (19 mph).

Lighting

Switching Automatic High Beam Control On or Off

To switch the system on or off, use the information display controls on the steering wheel to select the following:

Menu Item	Action
Settings	Press the menu button.
Vehicle settings	Press the OK button.
Lighting	Press the OK button.
Auto highbeam	Press the OK button.

Automatic High Beam Indicator



It illuminates to confirm when the system is ready to assist.

Overriding Automatic High Beam Control

Push the lever away from you to switch between high beam and low beam.

Automatic High Beam Control Information Messages

Message	Description
Front camera Low visibility Clean screen	The camera has reduced visibility. Clean the windshield. If the message continues to appear, have your vehicle checked as soon as possible.
Front camera temporarily not available	The camera has malfunctioned. Wait a short period of time for the camera to cool down. If the message continues to appear, have your vehicle checked as soon as possible.

Lighting

FRONT FOG LAMPS

Switching the Front Fog Lamps On or Off

Only switch the front fog lamps on during reduced visibility.

You can switch the front fog lamps on if any of the following occur:

- You set the lighting control to the parking lamps position.
- You set the lighting control to the headlamps position.
- You set the lighting control to the autolamps position and the headlamps are on.

The front fog lamp button is on the lighting control.



Press the button to switch the front fog lamps on or off.

Note: The brightness of the daytime running lamps may decrease when the front fog lamps are switched on.

Front Fog Lamp Indicator



It illuminates when you switch the front fog lamps on.

REAR FOG LAMPS

Switching the Rear Fog Lamps On or Off



WARNING: Do not use the rear fog lamps when it is raining or snowing and visibility is more than 50 m (164.0 ft).

You can switch the rear fog lamps on if any of the following occur:

- You switched the front fog lamps on.
- You set the lighting control to the headlamps position.
- You set the lighting control to the autolamps position and the headlamps are on.

The rear fog lamp button is on the lighting control.



Press the button to switch the rear fog lamps on or off.

Rear Fog Lamp Indicator



It illuminates when you switch the rear fog lamps on.

HEADLAMP LEVELING

To adjust the level of the headlamp beams, do the following:

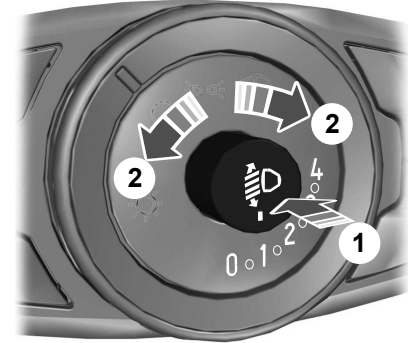

E132711

1. Press to release the control.
2. Rotate the control in accordance with your vehicle load to prevent you from distracting other road users when the headlamps are on.

Note: Set the control to zero when your vehicle is unloaded.

Lighting

Note: Set the headlamp beams to give between 35–100 m (115–328 ft) of road surface illumination when your vehicle is partially or fully loaded.

3. Press to close the control.

CORNERING LAMPS

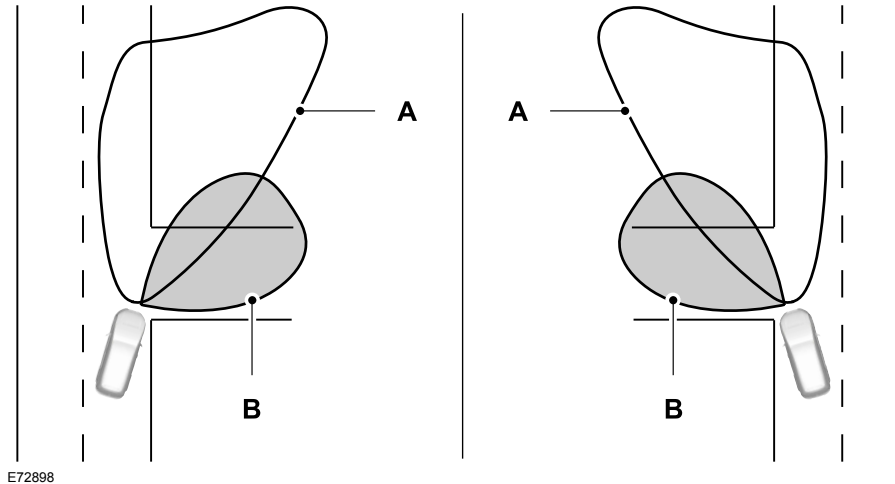

Lighting

- A Headlamp beam.
- B Cornering lamp beam.

The cornering lamps illuminate the inside of a corner when you are turning the steering wheel.

DIRECTION INDICATORS



Push the lever up or down to use the direction indicators.

Note: Tap the lever up or down to make the direction indicators flash three times.

INTERIOR LAMPS - VEHICLES WITH: FRONT INTERIOR LAMP

Switching All of the Interior Lamps On and Off

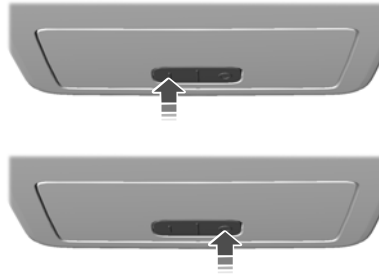

Switching the Rear Interior Lamps On and Off

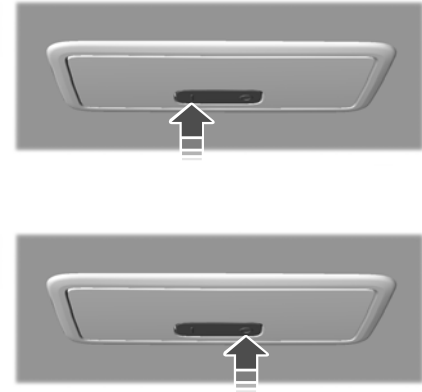

Lighting

Interior Lamp Function

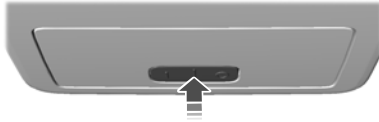

When you set the switch to the middle position, the interior lamps turn on if:

- You open a door.
- You press the unlock button on the remote control.
- You switch the ignition off.

Note: If you switch the ignition off, the interior lamps could turn off after a short time to prevent the vehicle battery from running out of charge.

INTERIOR LAMPS - VEHICLES WITH: FRONT INTERIOR LAMP WITH MAP READING LAMPS

Switching All of the Interior Lamps On and Off



Switching the Front Interior Lamps On and Off



E249791

Note: Press the edge of the lamps lens to switch the front interior lamp off before switching the ignition off to prevent the vehicle battery from running out of charge.

Switching the Rear Interior Lamps On and Off

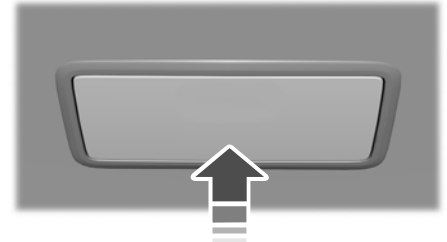

E250958

Lighting

Interior Lamp Function

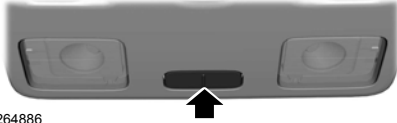

E264886

When you set the switch to the middle position, the interior lamps turn on if:

- You open a door.
- You press the unlock button on the remote control.
- You switch the ignition off.

Note: *If you switch the ignition off, the interior lamps could turn off after a short time to prevent the vehicle battery from running out of charge.*

Windows

OPENING AND CLOSING THE WINDOWS



WARNING: Do not leave children unattended in your vehicle and do not let them play with the power windows. Failure to follow this instruction could result in personal injury.



WARNING: When closing the power windows, verify they are free of obstruction and make sure that children and pets are not in the proximity of the window openings.



Press the window control switch to open the window. Lift the window control switch to close the window.

Note: *The power windows operate with the ignition on, and for several minutes after you switch the ignition off or until you open a front door.*

To reduce wind noise or pulsing noise when one window is open, slightly open the opposite window.

One-Touch Open

Fully press the window control switch and release it. Press again or lift it to stop the window.

One-Touch Close

Fully lift the window control switch and release it. Press again or lift it to stop the window.

Resetting One-Touch Close

Carry out all steps within 30 seconds of starting the sequence.

1. Close the window.
2. Press and hold the window control switch until the window is fully open. Keep the window control switch pressed for a few seconds.
3. Lift and hold the window control switch until the window is fully closed. Keep the window control switch held for a few seconds.
4. Press and hold the window control switch until the window is fully open. Keep the window control switch pressed for a few seconds.

5. Lift and hold the window control switch until the window is fully closed. Keep the window control switch held for a few seconds.

Note: *Repeat the procedure if the window does not close when you use one-touch.*

GLOBAL OPENING AND CLOSING

What Is Global Opening and Closing

You can use the remote control to operate the windows with the ignition off.

Using Global Opening

1. Press and release the unlock button on the remote control.
2. Press and hold the unlock button on the remote control.
3. Release the button when the windows and moonroof start to open.

Note: *The moonroof stops in the vent position.*

Press the lock or the unlock button on the remote control to stop global opening.

Note: *You can use global opening for a short period of time when you unlock your vehicle using the remote control.*

Windows

Switching Global Opening On and Off

1. Using the information display controls on the steering wheel, select **Settings**.
2. Select **Vehicle settings**.
3. Select **Windows**.
4. Switch **Global open** on or off.

Using Global Closing



WARNING: When closing the power windows, verify they are free of obstruction and make sure that children and pets are not in the proximity of the window openings.

1. Press and hold the lock button on the remote control.
2. Release the button when the windows and moonroof start to close.

Press the lock or the unlock button on the remote control to stop global closing.

Note: *Bounce-back is on during global closing. See **What Is Window Bounce-Back** (page 100).*

Switching Global Closing On and Off

1. Using the information display controls on the steering wheel, select **Settings**.
2. Select **Vehicle settings**.
3. Select **Windows**.
4. Switch **Global close** on or off.

WINDOW BOUNCE-BACK

What Is Window Bounce-Back

The window stops and reverses if it detects an obstruction when closing.

Overriding Window Bounce-Back



WARNING: If you override bounce-back, the window does not reverse if it detects an obstacle. Take care when closing the windows to avoid personal injury or damage to your vehicle.

1. Close the window until it reaches the point of resistance and let it reverse.

2. Lift the control within five seconds to override bounce-back and close the window. Bounce-back is now disabled and you can close the window manually.

Note: *The window goes past the point of resistance and you can fully close it.*

Note: *If the window does not close, have your vehicle checked as soon as possible.*

Resetting Window Bounce-Back



WARNING: Bounce-back is off until you reset the memory. Take care when closing the windows to avoid personal injury or damage to your vehicle.

If you have disconnected the battery, you must reset the bounce-back memory separately for each window.

Carry out all steps within 30 seconds of starting the sequence.

1. Close the window.
2. Press and hold the switch until the window is fully open. Keep the switch pressed for a few seconds.

Windows

3. Lift and hold the switch until the window is fully closed. Keep the switch held for a few seconds.
4. Press and hold the switch until the window is fully open. Keep the switch pressed for a few seconds.
5. Lift and hold the switch until the window is fully closed. Keep the switch held for a few seconds.

Note: Repeat the procedure if the window does not close when you use one-touch.

LOCKING THE REAR WINDOW CONTROLS



Press the window control switch to lock or unlock the rear window controls. It illuminates when you lock the rear window controls.

Interior Mirror

ADJUSTING THE INTERIOR MIRROR

 **WARNING:** Do not adjust the mirrors when your vehicle is moving. This could result in the loss of control of your vehicle, serious personal injury or death.

Pull the tab below the mirror toward you to reduce the effect of bright light from behind.

AUTO-DIMMING INTERIOR MIRROR

What Is the Auto-Dimming Interior Mirror

The mirror dims to reduce the effect of bright light from behind. It returns to normal when the bright light from behind is no longer present or if you shift into reverse (R).

Auto-Dimming Interior Mirror Precautions

 **WARNING:** Do not adjust the mirrors when your vehicle is moving. This could result in the loss of control of your vehicle, serious personal injury or death.

Do not block the sensors on the front and back of the mirror.

Note: *A rear center passenger or raised rear center head restraint could prevent light from reaching the sensor.*

Exterior Mirrors

ADJUSTING THE EXTERIOR MIRRORS

 **WARNING:** Do not adjust the mirrors when your vehicle is moving. This could result in the loss of control of your vehicle, serious personal injury or death.

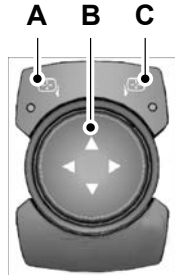

- A Left-hand mirror switch.
- B Mirror adjustment control.
- C Right-hand mirror switch.

FOLDING THE EXTERIOR MIRRORS - VEHICLES WITH: MANUAL FOLD EXTERIOR MIRRORS

Push the mirror toward the door window glass.

Make sure that you fully engage the mirror in its support when returning it to its original position.

FOLDING THE EXTERIOR MIRRORS - VEHICLES WITH: POWER FOLD EXTERIOR MIRRORS

The exterior mirrors fold when you lock your vehicle and unfold when you unlock your vehicle.



For tight parking conditions, press the control to fold the mirrors.

Press the control again to unfold the mirrors.

If you press the control to fold in the mirrors with auto-fold on, the mirrors do not unfold when you unlock your vehicle.

Note: The power folding mirrors operate with the ignition on, and for several minutes after you switch the ignition off.

Note: If you fold and unfold the mirrors several times within one minute, the power fold function may turn off to protect the motors from overheating.

Switching Auto-fold On and Off

1. Using the information display controls on the steering wheel, select **Settings**.
2. Select **Vehicle settings**.
3. Select **Mirrors**.
4. Switch **Autofold** on or off.

Moonroof

OPENING AND CLOSING THE SUN SHADE

The sun shade operates independently of the moonroof. Slide the sun shade backward or forward to open or close it.

OPENING AND CLOSING THE MOONROOF

Opening the Moonroof

 **WARNING:** Do not leave children unattended in your vehicle and do not let them play with the moonroof. Failure to follow this instruction could result in personal injury.

The moonroof controls are on the overhead console and have one-touch open.

To stop the motion during a one-touch operation, press the control a second time.



Press and release the rear of the control to vent the moonroof.

Press and release the rear of the control again to open the moonroof.

Closing the Moonroof

 **WARNING:** When closing the moonroof, verify that it is free of obstruction and make sure that children and pets are not in the proximity of the roof opening.

 **WARNING:** Do not leave children unattended in your vehicle and do not let them play with the moonroof. Failure to follow this instruction could result in personal injury.

The moonroof controls are on the overhead console and have one-touch close.

To stop the motion during a one-touch operation, press the control a second time.



Press and release the front of the control.

VENTING THE MOONROOF

 **WARNING:** Do not leave children unattended in your vehicle and do not let them play with the moonroof. Failure to follow this instruction could result in personal injury.



Press and release the rear of the control to vent the moonroof.

Press and release the front of the control to close the moonroof.

MOONROOF BOUNCE-BACK

The moonroof stops and reverses if it detects an obstruction.



Press and hold the front of the control within a few seconds to override bounce-back.

Instrument Cluster

GAUGES - EXCLUDING: MILD HYBRID ELECTRIC VEHICLE (MHEV)

Instrument Cluster

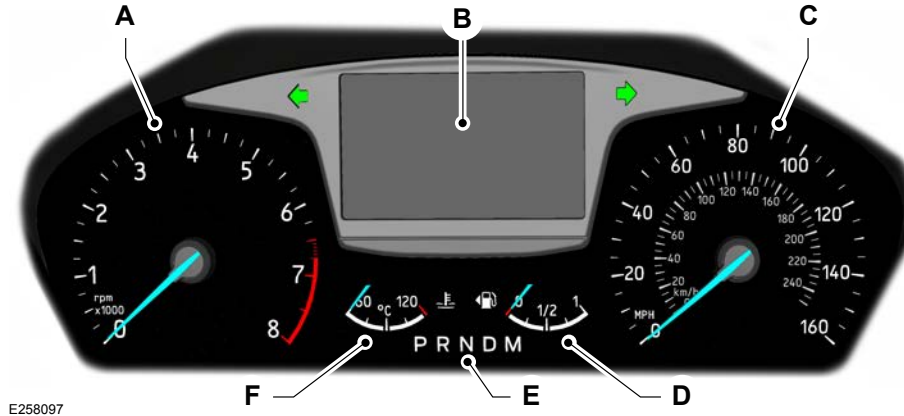

- A Tachometer.
- B Information display.
- C Speedometer.
- D Fuel gauge.

Instrument Cluster

- E Automatic transmission position indicators.
- F Engine coolant temperature gauge.

Tachometer

Shows the engine speed.

Information Display

Shows the following information:

- Odometer.
- Trip computer.
- MyView information.
- Driver assistance information.
- Navigation information.
- Audio information.
- Phone information.
- Vehicle and system settings.
- Outside air temperature.
- Shift indicators.

Odometer

Records the total distance traveled by your vehicle.

The system detects unauthorized odometer adjustments to avoid total distance reading fraud. If the system detects an unauthorized odometer adjustment, the total distance reading displays XXXX. Recovery of the original mileage could result in system damage not covered by the vehicle Warranty and may carry a significant expense.

Speedometer

Shows the vehicle speed.

Fuel Gauge

The fuel gauge indicates approximately how much fuel is in the fuel tank.

The arrow adjacent to the fuel pump symbol indicates on which side of your vehicle the fuel filler door is located.



A

B

E236403

- A The fuel filler door is on the left-hand side of your vehicle.
- B The fuel filler door is on the right-hand side of your vehicle.

Low Fuel Level Warning Lamp



If it illuminates when you are driving, refuel as soon as possible.

Low Fuel Level Audible Warning

For MyKey users, a warning tone sounds and a message appears in the information display when the distance to empty reaches 120 km (75 mi).

Instrument Cluster

For all keys, a warning tone sounds and a message appears in the information display when the distance to empty reaches 80 km (50 mi). A warning tone sounds and a message appears in the information display again at the following distance to empty parameters:

- 40 km (20 mi)
- 20 km (10 mi)
- 0 km (0 mi)

Note: *The low fuel reminder appears at different fuel gauge positions depending on fuel economy conditions. This variation is normal.*

Engine Coolant Temperature Gauge

At normal operating temperature, the needle remains in the center section. If the needle enters the red section, the engine is overheating. Stop your vehicle as soon as it is safe to do so, switch the engine off and allow it to cool.

Note: *The system reduces the engine speed if you continue to operate the engine at a high engine speed.*

Note: *Do not restart the engine until the cause of overheating has been determined and resolved.*

Engine Coolant Temperature Warning Lamp



If it illuminates when your vehicle is moving, this indicates that the engine is overheating. Stop your vehicle as soon as it is safe to do so and switch the engine off. Have your vehicle checked as soon as possible.

Automatic Transmission Position Indicators

The instrument cluster displays the current position. See **Automatic Transmission Position Indicators** (page 200).

Instrument Cluster

GAUGES - MILD HYBRID ELECTRIC VEHICLE (MHEV)

Instrument Cluster

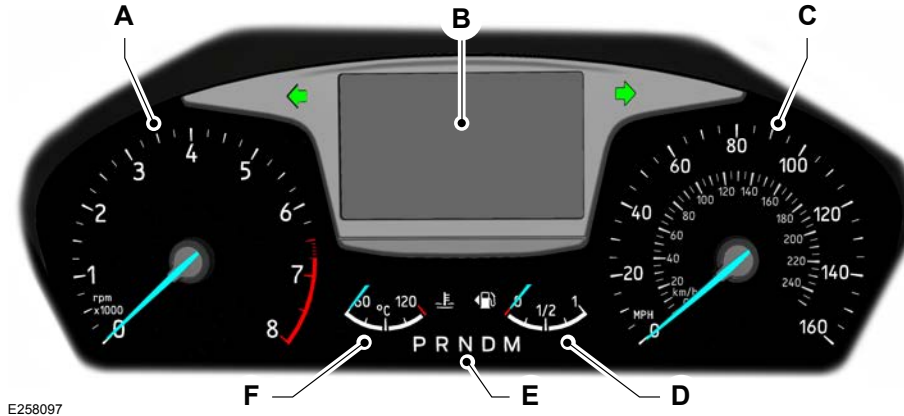

- A Tachometer.
- B Information display.
- C Speedometer.
- D Fuel gauge.

Instrument Cluster

- E Automatic transmission position indicators.
- F Engine coolant temperature gauge.

Tachometer

Shows the engine speed. The red line thickens where the engine speed enters the overspeed limiter.

Information Display

Shows the following information:

- Odometer.
- Trip computer.
- MyView information.
- Driver assistance information.
- Navigation information.
- Audio information.
- Phone information.
- Vehicle and system settings.
- Outside air temperature.
- Shift indicators.

Odometer

Records the total distance traveled by your vehicle.

The system detects unauthorized odometer adjustments to avoid total distance reading fraud. If the system detects an unauthorized odometer adjustment, the total distance reading displays XXXX. Recovery of the original mileage could result in system damage not covered by the vehicle Warranty and may carry a significant expense.

Trip Computer

See **Trip Computer** (page 117).

Vehicle and System Settings

See **General Information** (page 116).

Shift Indicator

See **Manual Transmission Shift Indicators** (page 197).

Speedometer

Shows the vehicle speed.

Fuel Gauge

The fuel gauge indicates approximately how much fuel is in the fuel tank.

The arrow adjacent to the fuel pump symbol indicates on which side of your vehicle the fuel filler door is located.



E236403

- A The fuel filler door is on the left-hand side of your vehicle.
- B The fuel filler door is on the right-hand side of your vehicle.

Low Fuel Level Warning Lamp



If the fuel gauge icon illuminates when you are driving, refuel as soon as possible.

Instrument Cluster

Low Fuel Level Audible Warning

For MyKey users, a warning tone sounds and a message appears in the information display when the distance to empty reaches 120 km (75 mi).

For all keys, a warning tone sounds and a message appears in the information display when the distance to empty reaches 80 km (50 mi). A warning tone sounds and a message appears in the information display again at the following distance to empty parameters:

- 40 km (20 mi)
- 20 km (10 mi)
- 0 km (0 mi)

Note: *The low fuel reminder appears at different fuel gauge positions depending on fuel economy conditions. This variation is normal.*

Engine Coolant Temperature Gauge

At normal operating temperature, the needle remains in the center section. If the needle enters the red section, the engine is overheating. Stop your vehicle as soon as it is safe to do so, switch the engine off and allow it to cool.

Note: *The system reduces the engine speed if you continue to operate the engine at a high engine speed.*

Note: *Do not restart the engine until the cause of overheating has been determined and resolved.*

Engine Coolant Temperature Warning Lamp



The engine coolant temperature gauge icon illuminates if the systems detects a malfunction.

Have your vehicle checked as soon as possible.

Automatic Transmission Gearshift Lever Position Indicator

Shows the selected gear. See **Automatic Transmission Position Indicators** (page 200).

Hybrid Gauge

1. Using the information display controls on the steering wheel, select **MyView**.
2. Select **Hybrid gauge**.

Note: *If you select any other screen than the hybrid gauge then the current status indicator of the hybrid system appears in the information display.*



Illuminates in the information display when the mild hybrid system is charging the battery.



Illuminates in the information display when the battery is assisting the powertrain in driving the vehicle.



Illuminates in the information display when the battery is providing a large amount of energy to the powertrain to support a higher rate of acceleration.



Illuminates in the information display when the mild hybrid system cannot provide energy to the powertrain.

Instrument Cluster

WARNING LAMPS AND INDICATORS

The following warning lamps and indicators alert you to a vehicle condition that may become serious. Some lamps illuminate when you start your vehicle to make sure they work. If any lamps remain on after starting your vehicle, refer to the respective system warning lamp for further information.

Note: *Some warning indicators appear in the information display and operate the same as a warning lamp but do not illuminate when you start your vehicle.*

Airbag Warning Lamp



If it does not illuminate when you switch the ignition on, continues to flash or remains on when the engine is running, this indicates a malfunction. Have your vehicle checked as soon as possible.

Anti-Lock Brake System Warning Lamp



If it illuminates when you are driving, this indicates a malfunction. Your vehicle continues to have normal braking without the anti-lock brake system function. Have your vehicle checked as soon as possible.

Automatic Headlamp High Beam Indicator (If Equipped)



It illuminates when the system turns the headlamp high beam on. See **Automatic High Beam Control** (page 92).

Auto-Start-Stop Indicator



It illuminates green when the engine has automatically stopped. It flashes to inform you when the engine needs to restart.

Note: *If it illuminates orange, the system has detected a fault that requires service. Have your vehicle checked as soon as possible.*



The indicator is shown with a strikethrough if the system is not available.

See **Auto-Start-Stop** (page 171). See **Auto-Start-Stop** (page 172).

Blind Spot Information System Indicator (If Equipped)



It illuminates when you switch the system off. See **Blind Spot Information System** (page 252).

Brake System Warning Lamp



WARNING: Driving your vehicle with the warning lamp on is dangerous. A significant decrease in braking performance may occur. It may take you longer to stop your vehicle. Have your vehicle checked as soon as possible. Driving extended distances with the parking brake engaged can cause brake failure and the risk of personal injury.



It illuminates when you engage the parking brake and the ignition is on.

Instrument Cluster

If it illuminates when your vehicle is moving, make sure the parking brake is disengaged. If the parking brake is disengaged, this indicates low brake fluid level or a brake system fault. Have your vehicle immediately checked.

Collision Warning System Indicator

(If Equipped)



It illuminates if your vehicle rapidly approaches another vehicle, to warn you of the risk of a crash with the vehicle in front of you.

It illuminates red if the distance to the vehicle ahead is small.

See **Pre-Collision Assist** (page 262).

Cruise Control Indicator



It illuminates when you switch the system on.

See **Cruise Control** (page 220).

Direction Indicator



Flashes when you switch the direction indicators on.

Note: *An increase in the rate of flashing warns of a failed indicator bulb.*

Door Ajar Warning Lamp



It illuminates when you switch the ignition on and remains on if any door or the hood is open.

Engine Coolant Temperature Warning Lamp



If it illuminates when your vehicle is moving, this indicates that the engine is overheating. Stop your vehicle as soon as it is safe to do so and switch the engine off. Have your vehicle checked as soon as possible.

Engine Warning Lamps



Service Engine Soon

If it illuminates when the engine is running this indicates a malfunction. Have your vehicle checked as soon as possible.

If it flashes when you are driving, reduce the speed of your vehicle immediately. Avoid heavy acceleration and deceleration and have your vehicle immediately serviced.



Malfunction Indicator Lamp

If it illuminates when the engine is running this indicates a malfunction. The On Board Diagnostics system has detected a malfunction of the vehicle emission control system.

If it flashes, engine misfire may be occurring. Increased exhaust gas temperatures could damage the catalytic converter or other vehicle components. Avoid heavy acceleration and deceleration and have your vehicle immediately serviced.

Fasten Seatbelt Warning Lamp



It illuminates and a chime sounds until you fasten the seatbelts.

Front Fog Lamp Indicator



It illuminates when you switch the front fog lamps on.

Instrument Cluster

Frost Warning Lamp



WARNING: Even if the temperature rises to above 4°C (39°F) there is no guarantee that the road is free of hazards caused by inclement weather.



It illuminates when the outside air temperature is 4°C (39°F) or below.

Glow Plug Indicator



If it illuminates, wait until it turns off before starting.

Hazard Flasher Indicator



Flashes when you switch the hazard flashers on.

Headlamp High Beam Indicator



It illuminates when you switch the headlamp high beam on. It illuminates when the system turns the headlamp high beam on.

Headlamp Low Beam Warning Lamp



If it illuminates when the low beam headlamps are on, this indicates that a headlamp low beam bulb has failed.

Ignition Warning Lamp



It illuminates when you switch the ignition on.

If it illuminates when the engine is running this indicates a malfunction. Have your vehicle checked as soon as possible.

Lamps on Indicator



It illuminates when you switch the headlamp low beam or the side and rear lamps on.

Launch Control Indicator (If Equipped)



It illuminates when you switch the system on.

Lane Keeping Alert Indicator



It illuminates when you switch the system on.

Lane Keeping Aid Warning Lamp (If Equipped)



It illuminates when you switch the system on. See **Lane Keeping System** (page 248).

Low Fuel Level Warning Lamp



If it illuminates when you are driving, refuel as soon as possible.

Low Tire Pressure Warning Lamp (If Equipped)



It illuminates if the tire pressure in one or more tires is below the correct tire pressure.

See **What Is the Tire Pressure Monitoring System** (page 372).

Oil Pressure Warning Lamp



It illuminates when you switch the ignition on.

Instrument Cluster

If it illuminates when the engine is running this indicates a malfunction. Stop your vehicle as soon as it is safe to do so and switch the engine off. Check the engine oil level. If the oil level is sufficient, this indicates a system malfunction. Have your vehicle immediately checked.

See **Engine Oil Check** (page 317).

Over Speed Warning Indicator (If

Equipped)



It illuminates when the vehicle speed exceeds 120 km/h (75 mph).

Performance Shift Indicator (If Equipped)



It illuminates when the powertrain reaches the optimum upshift point. It flashes when the engine is close to hitting the engine speed limiter.

Rear Fog Lamp Indicator



It illuminates when you switch the rear fog lamps on.

Shift Indicator



It illuminates to advise you that shifting to a higher or lower gear may give better performance, fuel economy or lower emissions.



Stability Control and Traction Control Indicator



Flashes during operation.

If it does not illuminate when you switch the ignition on, or remains on when the engine is running, this indicates a malfunction. Have your vehicle checked as soon as possible.

Note: *The system automatically turns off if there is a malfunction.*

See **Stability Control** (page 207). See **Traction Control** (page 206).

Stability Control and Traction Control Off Warning Lamp



It illuminates when you switch the system off.

See **Stability Control** (page 207).

AUDIBLE WARNINGS AND INDICATORS

Airbag Secondary Warning

Sounds when the airbag warning lamp is not working. Sounds when the airbag warning lamp malfunction tone is not working.

Auto-Start-Stop Warning

Sounds when you open the driver door and Auto-Start-Stop has turned the engine off.

Automatic Transmission

Sounds when you open the driver door and the transmission is not in park (P).

Door Ajar

Sounds when a door is not fully closed and your vehicle is moving.

Exterior Lamps On

Sounds when you open the driver door and the exterior lamps are on.

Low Fuel Reminder

Sounds when the fuel level is low.

Instrument Cluster

Key Outside Vehicle

Sounds when you remove the passive key from your vehicle and the engine is running.

Over Speed Warning

Sounds when your vehicle speed exceeds a set limit.

Parking Brake On

Sounds when the parking brake is on and your vehicle is moving.

Seatbelt Reminder

Sounds when a seatbelt is unfastened in an occupied seat and your vehicle is moving.

Information Displays

GENERAL INFORMATION

WARNING: Driving while distracted can result in loss of vehicle control, crash and injury. We strongly recommend that you use extreme caution when using any device that may take your focus off the road. Your primary responsibility is the safe operation of your vehicle. We recommend against the use of any hand-held device while driving and encourage the use of voice-operated systems when possible. Make sure you are aware of all applicable local laws that may affect the use of electronic devices while driving.

Note: For your safety, some features are speed-dependent. Their use is limited to when your vehicle speed is not moving.

Information Display Controls

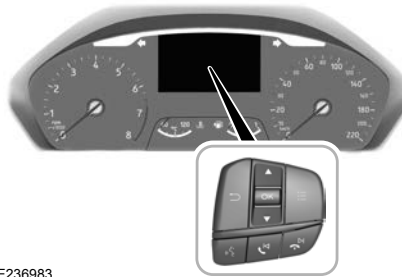

E236983

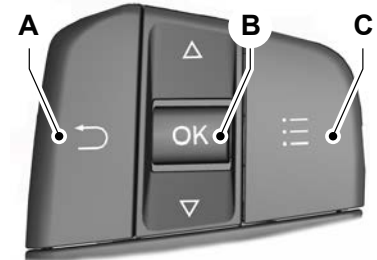

E250032

- A Return button.
- B OK button.
- C Menu button.

Return Button

Use the return button to go back or to exit.

OK Button

Use the **OK** button to make a selection. You can also use it to scroll through a menu.

Menu Button

Use the menu button on the main screen to display the submenu.

Information Displays

Information Display Main Menu

Menu Item
<i>Trip computer 1</i> or <i>Trip computer 2</i>
MyView
Driver assist.

Menu Item
Navigation
Audio
Phone
Settings

TRIP COMPUTER

You can reset the trip computer and personalize it using the information display. See **Information Displays** (page 116).

Resetting the Trip Computer

Navigate to the following main menu item.

Menu Item	Action
Trip computer 1	Press and hold the OK button until the system reset confirmation appears.
Trip computer 2	Press and hold the OK button until the system reset confirmation appears.

Alternatively you can reset individual trip values.

Menu Item	Action
Trip computer 1	Press the menu button.
Trip computer 2	Press the menu button.
Reset individual values	Press the OK button.
Reset trip odometer	Press and hold the OK button until the system reset confirmation appears.

Information Displays

Menu Item	Action
Reset trip timer	Press and hold the OK button until the system reset confirmation appears.
Reset average fuel	Press and hold the OK button until the system reset confirmation appears.
Reset average speed	Press and hold the OK button until the system reset confirmation appears.

Personalization

Navigate to the following main menu item.

Menu Item	Action
Trip computer 1	Press the menu button.
Trip computer 2	Press the menu button.
Configure view	Press the OK button.
Trip odometer	Press the OK button.
Trip timer	Press the OK button.
Average fuel consumption	Press the OK button.
Average speed	Press the OK button.
Distance to empty	Press the OK button.
Instantaneous fuel	Press the OK button.

Note: You can display a maximum of four values.

Information Displays

Trip Odometer

Registers the total distance since you last reset the value.

Trip Timer

Registers the total time since you last reset the value.

Average Fuel

Indicates the average fuel consumption since you last reset the value.

Average Speed

Indicates the average vehicle speed since you last reset the value.

Distance to Empty

Indicates the approximate distance your vehicle could travel on the fuel remaining in the fuel tank. Changes in driving pattern may cause the value to vary.

Instantaneous Fuel

Indicates the current fuel consumption.

PERSONALIZED SETTINGS

Language

Menu Item	Action
Settings	Press the menu button.
Display	Press the OK button.
Language	Press the OK button. Choose your applicable setting.

Information Displays

Measure Unit

Menu Item	Action
Settings	Press the menu button.
Display	Press the OK button.
Measurement unit	Press the OK button. Choose your applicable setting.

Temperature Unit

Menu Item	Action
Settings	Press the menu button.
Display	Press the OK button.
Temperature unit	Press the OK button. Choose your applicable setting.

Tire Pressure Unit (If Equipped)

Menu Item	Action
Settings	Press the menu button.
Display	Press the OK button.
Tyre pressure	Press the OK button. Choose your applicable setting.

Information Displays

Chimes

Menu Item	Action
Settings	Press the menu button.
Vehicle settings	Press the OK button.
Chimes	Press the OK button.
Parking space found	Press the OK button.
Information	Press the OK button.

INFORMATION MESSAGES

Active Park Assist

Message	Description
Active Park malfunction	The system has malfunctioned. Have your vehicle checked as soon as possible.

Information Displays

Adaptive Cruise Control

Message	Description
Adaptive cruise control malfunction	The system has malfunctioned. Have your vehicle checked as soon as possible.
Adaptive cruise control not available	The system is not available. See Using Adaptive Cruise Control (page 232).
Adaptive cruise control not available Sensor blocked See manual	The radar has reduced visibility. See Using Adaptive Cruise Control (page 232).
Cruise control active Adaptive braking off	You have switched normal cruise control on. Adaptive braking turns off.
Front sensor not aligned	The system has malfunctioned. Have your vehicle checked as soon as possible.
Adaptive cruise control Driver resume control	The adaptive cruise has reinstated controls to the driver.
Adaptive cruise control Speed too low to activate	Your vehicle speed is too slow to activate the adaptive cruise.
Adaptive cruise control Speed sign recognition not available	Navigation system based speed limit information is not available. If the message continues to appear, have your vehicle checked as soon as possible.

Alarm

Message	Description
Vehicle alarm Start vehicle to stop alarm	Displays when the alarm has been triggered due to unauthorized entry.

Information Displays

Automatic High Beam Control

Message	Description
Front camera Low visibility Clean screen	The camera has reduced visibility. Clean the windshield. If the message continues to appear, have your vehicle checked as soon as possible.
Front camera temporarily not available	The camera has malfunctioned. Wait a short period of time for the camera to cool down. If the message continues to appear, have your vehicle checked as soon as possible.
Front camera malfunction Service required	The camera has malfunctioned. Have your vehicle checked as soon as possible.

Auto-Start-Stop

Message	Description
Auto StartStop Press Brake to Start Engine	The system needs to restart the engine but requires your confirmation. Press the brake pedal to restart the engine.
Auto StartStop Press clutch to start engine	The system needs to restart the engine but requires your confirmation. Press the clutch pedal to restart the engine.
Auto StartStop Press a Pedal to Start Engine	The system needs to restart the engine but requires your confirmation. Press any pedal to restart the engine.
Auto StartStop Select Neutral To Start Engine	The system needs to restart the engine but requires your confirmation. Shift into neutral (N) to restart the engine.

Information Displays

Message	Description
Auto StartStop Shift to P, then Restart Engine	The system needs to restart the engine but requires your confirmation. Shift into park (P) to restart the engine.
Auto StartStop Manual Restart Required	The system is not functioning. Restart the engine.
Auto StartStop malfunction Service required	The system has malfunctioned. Have your vehicle checked as soon as possible.

Blind Spot Information and Cross Traffic Alert Systems

Message	Description
BLIS malfunction	The system has malfunctioned. Have your vehicle checked as soon as possible.
BLIS not available Sensor blocked See manual	The system sensors are blocked. See Blind Spot Information System (page 252).
BLIS deactivated Trailer attached	You have attached a trailer to your vehicle. The system turns off.
Vehicle coming from left Vehicle coming from right	The system detects a vehicle. See Blind Spot Information System (page 252).
Cross traffic alert	Displays instead of indication arrows when the system detects a vehicle. Check for approaching traffic.
Cross traffic malfunction	The system has malfunctioned. Have your vehicle checked as soon as possible.

Information Displays

Message	Description
Cross traffic not available Sensor blocked See manual	The system sensors are blocked. See Cross Traffic Alert (page 254).
Cross traffic alert deactivated Trailer attached	You have attached a trailer to your vehicle. The system turns off.
Cross traffic alert Applying brakes	The system applies the brakes. Check for approaching traffic.

Brake System

Message	Description
Check brake system	The system has malfunctioned. Stop your vehicle in a safe place. Have your vehicle checked as soon as possible.

Information Displays

Doors and Locks

Message	Description
Driver door open Passenger door open Rear left door open Rear right door open Liftgate open	The door listed is not completely closed.
Bonnet open	The hood is not completely closed.
Switches inhibited Security mode	The system has disabled the door switches.

Driver Alert

Message	Description
Driver fatigue warning Rest now	Take a break due to low alertness levels.
Driver fatigue warning Rest suggested	We recommend that you take a break due to low alertness levels.

Information Displays

Engine

Message	Description
Engine coolant overtemperature	Displays when the engine temperature is too high. Stop your vehicle as soon as it is safe to do so, switch the engine off and allow it to cool. Have your vehicle checked as soon as possible.

Fuel System

Message	Description
Fuel level low	An early reminder of a low fuel condition.
Fuel level low distance metric:##0 km to empty	
Fuel level low distance imperial:##0 miles to empty	
Check fuel fill inlet	The fuel fill inlet may not be properly closed.
Fuel pressure low	The system has malfunctioned. Have your vehicle checked as soon as possible.
Water in fuel Drain filter	The system detects there is excess water in the fuel filter. Have your vehicle checked as soon as possible.

Information Displays

Headlamps

Message	Description
Check adaptive headlamps See manual	Displays if an electrical malfunction occurs with the headlamp system. Have your vehicle checked as soon as possible.

Hill Start Assist

Message	Description
Hill start assist not available	The system is not available. Have your vehicle checked as soon as possible. See Hill Start Assist (page 204).

Lane Keeping System

Message	Description
Lane keeping system malfunction Service required	The system has malfunctioned. Have your vehicle checked as soon as possible.

Information Displays

Maintenance

Message	Description
Engine oil level low Add oil	The engine oil level is low. Stop your vehicle as soon as it is safe to do so and switch the engine off. Check the engine oil level. See Engine Oil Check (page 317). If the message continues to appear, have your vehicle checked as soon as possible.
Engine oil pressure low	The engine oil pressure is low. Stop your vehicle as soon as it is safe to do so and switch the engine off. Check the engine oil level. See Engine Oil Check (page 317). If the message continues to appear, have your vehicle checked as soon as possible.
Change engine oil soon	The engine oil life remaining is 10% or less. See Engine Oil Check (page 317).
Oil change required	The oil life left is at 0%. See Engine Oil Check (page 317).
Brake fluid level low	The brake fluid level is low or the brake system has malfunctioned. See Brake Fluid Check (page 321). Have your vehicle checked as soon as possible.
Power reduced to lower engine temperature	The engine has reduced power to help reduce high engine temperature.
Transport mode Contact dealer	Transport mode is on. This may not allow some features to properly operate. Have your vehicle checked as soon as possible.
Factory mode Contact dealer	Factory mode is on. This may not allow some features to properly operate. Have your vehicle checked as soon as possible.

Information Displays

MyKey

Message	Description
Place key in backup location	Displays when trying to create a MyKey and the key is not placed in the backup position. See Passive Key Backup Position (page 58).
Key is already a MyKey	Displays when trying to create a MyKey with a key already designated as a MyKey.
Hold OK to create MyKey	Displays when creating a MyKey.
Creation completed	Displays to confirm that a MyKey has been created.
Key restricted at next start. Label this key	Displays to confirm that the key is restricted after you switch the ignition off.
MyKey not created	Displays if the system fails to create a MyKey.
Hold OK to clear MyKeys	Displays when clearing all MyKeys.
All MyKeys cleared	Displays to confirm that all MyKeys have been cleared.

Information Displays

Parking Aid

Message	Description
Parking aid malfunction	The system has malfunctioned. Have your vehicle checked as soon as possible.
Check Park Pilot	
Check front Park Pilot Check rear Park Pilot	
Park Pilot not available sensor blocked See Manual Front Park Pilot not available sensor blocked See Manual Rear Park Pilot not available Sensor blocked See manual	The system sensors are blocked. See Parking Aids (page 208).
Rear Park Pilot disabled Trailer attached	You have attached a bike rack, trailer or other object near the sensors on the front or rear of your vehicle.

Parking Brake

Message	Description
Park brake applied	You have not released the parking brake and your vehicle reaches 5 km/h (3 mph). If the message continues to appear after you have released the parking brake, have your vehicle checked as soon as possible.

Information Displays

Pre-Collision Assist

Message	Description
Pre-collision assist not available	The system has malfunctioned. Have your vehicle checked as soon as possible.
Pre-collision assist not available Sensor blocked	The system sensors are blocked. See Pre-Collision Assist (page 262).

Rear Window Lock

Message	Description
Child lock malfunction See manual	The system has malfunctioned. Have your vehicle checked as soon as possible.

Remote Control

Message	Description
Key battery low Replace soon	The key battery is low. Change the battery as soon as possible.

Seatbelt Reminder

Message	Description
Rear belt monitor malfunction Service required	The system has malfunctioned. Have your vehicle checked as soon as possible.

Information Displays

Selectable Drive Modes

Message	Description
Drive mode not available	The system is not available. If it is still not available the next time you switch the ignition on, the system has malfunctioned. Have your vehicle checked as soon as possible.

Stability Control

Message	Description
ESC Service required	The system has malfunctioned. Have your vehicle checked as soon as possible.

Starting System

Message	Description
Full accessory power active	Displays if you switch the ignition on and do not start the engine.
Press brake to start	A reminder to press the brake pedal when starting your vehicle.
Press clutch to start	A reminder to press the clutch pedal when starting your vehicle.
Press brake and clutch to start	A reminder to press the brake and clutch pedals when starting your vehicle.
Cranking time exceeded	Displays if your vehicle fails to start.

Information Displays

Message	Description
No key detected	The system does not detect a valid passive key inside your vehicle.
Starting system malfunction	The system has malfunctioned. Have your vehicle checked as soon as possible.
Restart now or key is needed	Displays if you switch the engine off and the system does not detect a valid passive key inside your vehicle.

Steering System

Message	Description
Steering loss Stop safely	The system has malfunctioned. Stop your vehicle in a safe place. Have your vehicle checked as soon as possible.
Steering malfunction Service now	The system has malfunctioned. Have your vehicle checked as soon as possible.
Steering assist malfunction Service required	
Steering Lock Malfunction Service Now	

Information Displays

Tire Pressure Monitoring System

Message	Description
Tyre pressure low	One or more tires on your vehicle have low tire pressure.
Tyre pressure monitor malfunction	The system has malfunctioned. Have your vehicle checked as soon as possible.
Tyre pressure sensor malfunction	The system has malfunctioned or the spare tire is in use. If the message continues to appear, have your vehicle checked as soon as possible.

Transmission

Message	Description
Transmission malfunction Service now Transmission Service required	The system has malfunctioned. Have your vehicle checked as soon as possible.
Transmission overtemperature Stop safely Transmission overheating Stop safely Transmission too hot Press brake	The transmission is overheating and needs to cool. Stop your vehicle as soon as it is safe to do so, switch the engine off and allow the transmission to cool. If the message continues to appear, have your vehicle checked as soon as possible.
Transmission limited function See manual	The transmission has limited functionality. Have your vehicle checked as soon as possible.
Transmission warming up Please wait	Displays at low outside temperatures, if it takes a few seconds for the transmission to engage a gear. Fully press the brake pedal until the message disappears from the information display.

Information Displays

Message	Description
Transmission not in Park	Displays as a reminder to shift into park (P).
Press brake to unlock selector lever	Press the brake pedal to unlock the transmission.
Selector lever unlocked	Displays when the selector lever unlocks.

Remote Start - Automatic Transmission

WHAT IS REMOTE START

The system allows you to remotely start your vehicle and therefore to heat or cool the interior to a predetermined temperature.

REMOTE START LIMITATIONS

Remote start does not work if:

- The alarm horn is sounding.
- The hood is open.
- The transmission is not in park (P).
- Remote start is not enabled.
- The ignition is on.

Note: Do not use remote start if your fuel level is low.

ENABLING REMOTE START

1. Using the information display controls on the steering wheel, select **Settings**.
2. Select **Vehicle settings**.
3. Select **Remote start**.
4. Switch **System** on.

Note: To use remote start, make sure that the modem is enabled. See **Enabling and Disabling the Modem** (page 399).

REMOTELY STARTING AND STOPPING THE VEHICLE



Use the FordPass App to start the vehicle.

Note: The turn signal lamps flash twice.

Note: The parking lamps turn on when the vehicle is running.

Note: The horn sounds if the system fails to start.

Note: All other vehicle systems remain off when you have remotely started the vehicle.

Note: You may have to wait a short period of time before remotely starting the vehicle after the vehicle stops running.

Note: The vehicle remains secured when you have remotely started it. A valid key must be inside your vehicle to switch the ignition on and drive your vehicle.

Note: A maximum of two remote starts are allowed. After that you need to turn the ignition on and off before you can use remote start again.

Use the FordPass App to switch the vehicle off.

REMOTE START SETTINGS - VEHICLES WITHOUT: HEATED STEERING WHEEL

Climate Control Settings

1. Using the information display controls on the steering wheel, select **Settings**.
2. Select **Vehicle settings**.
3. Select **Remote start**.
4. Select **Climate control**.
5. Select **Auto** or **Last settings**.

Note: If you select **Auto**, the system attempts to heat or cool the interior to 22°C (72°F).

Note: If you select **Last settings**, the system remembers the last used settings.

Remote Start - Automatic Transmission

Note: You cannot adjust the climate control settings when you have remotely started the vehicle.

Note: When you switch the ignition on, the climate control system returns to the last used settings.

Heated Seat Settings

1. Using the information display controls on the steering wheel, select **Settings**.
2. Select **Vehicle settings**.
3. Select **Remote start**.
4. Select **Seats**.
5. Select **Auto** or **Off**.

Note: If you switch the heated seat settings to **Auto**, the heated seats turn on during cold weather.

Note: You cannot adjust the heated seat settings when you have remotely started the vehicle.

Setting the Remote Start Duration

You can set a duration for Remote Start to run.

1. Using the information display controls on the steering wheel, select **Settings**.
2. Select **Vehicle settings**.

3. Select **Remote start**.
4. Select **Duration**.

REMOTE START SETTINGS - VEHICLES WITH: HEATED STEERING WHEEL

Climate Control Settings

1. Using the information display controls on the steering wheel, select **Settings**.
2. Select **Vehicle settings**.
3. Select **Remote start**.
4. Select **Climate control**.
5. Select **Auto** or **Last settings**.

Note: If you select **Auto**, the system attempts to heat or cool the interior to 22°C (72°F).

Note: If you select **Last settings**, the system remembers the last used settings.

Note: You cannot adjust the climate control settings when you have remotely started the vehicle.

Note: When you switch the ignition on, the climate control system returns to the last used settings.

Heated Seat and Steering Wheel Settings

1. Using the information display controls on the steering wheel, select **Settings**.
2. Select **Vehicle settings**.
3. Select **Remote start**.
4. Select **Seats and steering**.
5. Select **Auto** or **Off**.

Note: If you switch the heated seat and steering wheel settings to **Auto**, the heated seats and steering wheel turn on during cold weather.

Note: You cannot adjust the heated seat and steering wheel settings when you have remotely started the vehicle.

Setting the Remote Start Duration

You can set a duration for Remote Start to run.

1. Using the information display controls on the steering wheel, select **Settings**.
2. Select **Vehicle settings**.
3. Select **Remote start**.
4. Select **Duration**.

Climate Control - Vehicles With: Automatic Temperature Control

SWITCHING CLIMATE CONTROL ON AND OFF



Press the button.

SWITCHING RECIRCULATED AIR ON AND OFF



Press the button to recirculate air currently in the passenger compartment.

Note: Recirculated air could turn off or be prevented from turning on in all air flow modes except maximum cooling to reduce the risk of the windows fogging up.

Note: Recirculated air could turn on and off when you direct air to the instrument panel or footwell air vents during hot weather to improve cooling efficiency.

SWITCHING AIR CONDITIONING ON AND OFF



Press the button.

Note: Under certain conditions, the air conditioning compressor could continue to operate after you switch air conditioning off.

SWITCHING MAXIMUM DEFROST ON AND OFF



Press the button.

Note: When you switch maximum defrost on, the heated windshield, heated rear window and air conditioning turn on. The blower motor is set to the highest speed.

Note: When you switch maximum defrost off, the heated windshield and heated rear window remain on.

SWITCHING MAXIMUM COOLING ON AND OFF



Press the button.

Note: When you switch maximum cooling off, air conditioning remains on.

SWITCHING THE HEATED WINDSHIELD ON AND OFF



Press the button to clear the windshield of thin ice and fog. The heated windshield turns off after a short period of time.

Note: Make sure that the engine is running before switching the heated windshield on.

Note: The system does not operate if the battery charge level is low.

SWITCHING THE HEATED REAR WINDOW ON AND OFF



Press the button to clear the rear window of thin ice and fog. The heated rear window turns off after a short period of time.

Note: Do not use harsh chemicals, razor blades or other sharp objects to clean or remove decals from the inside of the heated rear window as this could cause damage to the heated rear window grid lines not covered by the vehicle Warranty.

Climate Control - Vehicles With: Automatic Temperature Control

SWITCHING THE HEATED MIRRORS ON AND OFF

When you switch the heated rear window on, the heated exterior mirrors turn on.

Note: Do not remove ice from the mirrors with a scraper or adjust the mirror glass when it is frozen in place.

Note: Do not clean the mirror housing or glass with harsh abrasives, fuel or other petroleum-based cleaning products. The vehicle warranty may not cover damage caused to the mirror housing or glass.

SETTING THE BLOWER MOTOR SPEED



Note: Lights on the control illuminate to indicate the blower motor speed.

SETTING THE TEMPERATURE

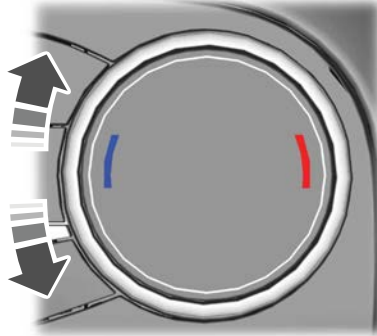

Turn the temperature control counterclockwise for cooler temperature settings.

Turn the temperature control clockwise for warmer temperature settings.

Note: You can adjust the temperature between 15.5–29.5°C (60–85°F).

CLIMATE CONTROL – TROUBLESHOOTING

Climate Control – Frequently Asked Questions

Why is the volume of air to the rear passenger compartment limited ?

Objects may obstruct the air direction to the rear passenger compartment. Make sure objects have not been placed under the front seats.

Why is the volume of air from the air vents reduced?

The air intake area at the base of the windshield could be obstructed. Make sure the air intake area is free from any snow, ice or leaves.

What are the recommended settings for heating the interior?

Auto mode on and instrument panel and side air vents fully open.

How can I quickly heat the interior?

Select the highest blower motor speed, highest temperature and direct the air to the footwell air vents.

Climate Control - Vehicles With: Automatic Temperature Control

What are the recommended settings for cooling the interior?

Auto mode on.

How can I quickly cool the interior?

Switch maximum cooling on, switch recirculated air on and drive with the windows open until you feel cold air through the air vents.

How can I reduce the humidity build-up inside my vehicle?

Do not drive with the system off or with recirculated air on.

How can I defog the side windows?

Switch maximum defrost on.

How can I defog or clear the windshield of thin ice?

Switch maximum defrost on.

Why do I feel air from the footwell air vents regardless of the air distribution?

This is normal operation. You may feel a small amount of air from the footwell air vents regardless of the air distribution.

What happens if I switch auto mode on when the outside temperature and in-vehicle temperature is high?

The system temporarily selects recirculated air to maximize cooling.

What happens if I switch auto mode on when the outside temperature is low and the engine is cold?

Air is directed to the windshield and the outer instrument panel air vents.

Climate Control - Vehicles With: Manual Temperature Control

SWITCHING CLIMATE CONTROL ON AND OFF



Press the button.

SWITCHING RECIRCULATED AIR ON AND OFF



Note: The air currently in the passenger compartment recirculates.

SWITCHING AIR CONDITIONING ON AND OFF



Press the button.

Note: Under certain conditions, the air conditioning compressor could continue to operate after you switch air conditioning off.

SWITCHING MAXIMUM DEFROST ON AND OFF



Turn the temperature control clockwise past the highest setting to maximize defrosting.

Note: The temperature control springs back to the highest setting.

Note: When you switch maximum defrost on, the heated windshield, heated rear window and air conditioning turn on. The blower motor is set to the highest speed.

Note: When you switch maximum defrost off, the heated windshield and heated rear window remain on.

SWITCHING MAXIMUM COOLING ON AND OFF



Turn the temperature control counterclockwise past the lowest setting to maximize cooling.

Note: The temperature control springs back to the lowest setting.

Note: When you switch maximum cooling off, air conditioning remains on.

SWITCHING THE HEATED WINDSHIELD ON AND OFF



Press the button to clear the windshield of thin ice and fog. The heated windshield turns off after a short period of time.

Note: Make sure that the engine is running before switching the heated windshield on.

Note: The system does not operate if the battery charge level is low.

SWITCHING THE HEATED REAR WINDOW ON AND OFF



Press the button to clear the rear window of thin ice and fog. The heated rear window turns off after a short period of time.

Note: Make sure the engine is on before operating the heated windows.

Note: Do not use razor blades or other sharp objects to clean or remove decals from the inside of the heated rear window. The vehicle Warranty may not cover damage caused to the heated rear window grid lines.

Climate Control - Vehicles With: Manual Temperature Control

SWITCHING THE HEATED MIRRORS ON AND OFF

When you switch the heated rear window on, the heated exterior mirrors turn on.

Note: Do not remove ice from the mirrors with a scraper or adjust the mirror glass when it is frozen in place.

Note: Do not clean the mirror housing or glass with harsh abrasives, fuel or other petroleum-based cleaning products. The vehicle warranty may not cover damage caused to the mirror housing or glass.

SETTING THE BLOWER MOTOR SPEED



Note: Lights on the control illuminate to indicate the blower motor speed.

Note: When you switch the blower motor off, air conditioning turns off and the windows could fog up.

SETTING THE TEMPERATURE

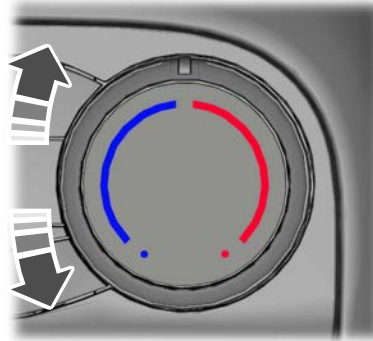

Turn the temperature control counterclockwise for cooler temperature settings.

Turn the temperature control clockwise for warmer temperature settings.

CLIMATE CONTROL – TROUBLESHOOTING

Climate Control – Frequently Asked Questions

Why is the volume of air to the rear passenger compartment limited?

Objects may obstruct the air direction to the rear passenger compartment. Make sure objects have not been placed under the front seats.

Why is the volume of air from the air vents reduced?

The air intake area at the base of the windshield could be obstructed. Make sure the air intake area is free from any snow, ice or leaves.

What are the recommended settings for heating the interior?

A medium blower motor speed selected and the air directed to the footwell and windshield air vents.

How can I quickly heat the interior?

Select the highest blower motor speed, highest temperature and direct the air to the footwell air vents.

Climate Control - Vehicles With: Manual Temperature Control

What are the recommended settings for cooling the interior?

Air conditioning on, a medium blower motor speed selected and air directed to the footwell and windshield air vents.

How can I quickly cool the interior?

Switch maximum cooling on, switch recirculated air on and drive with the windows open until you feel cold air through the air vents.

How can I reduce the humidity build-up inside my vehicle?

Do not drive with the system off or with recirculated air on.

How can I defog the side windows?

Switch maximum defrost on.

How can I defog or clear the windshield of thin ice?

Switch maximum defrost on.

Why do I feel air from the footwell air vents regardless of the air distribution?

This is normal operation. You may feel a small amount of air from the footwell air vents regardless of the air distribution.

Seats

SITTING IN THE CORRECT POSITION

WARNING: Do not recline the seat backrest too far as this can cause the occupant to slide under the seatbelt, resulting in personal injury in the event of a crash.

WARNING: Always sit upright against your seatback with your feet on the floor.

WARNING: Do not place objects higher than the top of the seat backrest. Failure to follow this instruction could result in personal injury or death in the event of a sudden stop or crash.

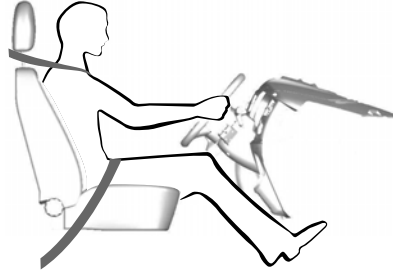

When you use them properly, the seat, head restraint, seatbelt and airbags will provide optimum protection in the event of a crash.

We recommend that you follow these guidelines:

- Sit in an upright position with the base of your spine as far back as possible.
- Do not recline the seat backrest so that your torso is more than 30 degree from the upright position.
- Adjust the head restraint so that the top of it is level with the top of your head and as far forward as possible. Make sure that you remain comfortable.

- Keep sufficient distance between yourself and the steering wheel. We recommend a minimum of 25 cm (10 in) between your breastbone and the airbag cover.
- Hold the steering wheel with your arms slightly bent.
- Bend your legs slightly so that you can press the pedals fully.
- Position the shoulder strap of the seatbelt over the center of your shoulder and position the lap strap tightly across your hips.

Make sure that your driving position is comfortable and that you can maintain full control of your vehicle.

HEAD RESTRAINTS

WARNING: Fully adjust the head restraint before you sit in or operate your vehicle. This will help minimize the risk of neck injury in the event of a crash. Do not adjust the head restraint when your vehicle is moving.

WARNING: Raise the rear head restraints when passengers occupy the rear seats.

Seats

 **WARNING:** Do not remove the head restraint from an occupied seat.

Adjusting the Head Restraints

Adjust the head restraint so that the top of it is level with the top of your head.

Raising the Head Restraints

1. Pull the head restraint upward.
2. Make sure the head restraint locks into place.

Lowering the Head Restraints

1. Press the left-hand side locking button.
2. Push the head restraint downward.
3. Make sure the head restraint locks into place.

Removing the Head Restraints

Front Head Restraints

1. Recline the seat backrest so that there is enough room for you to remove the head restraint.

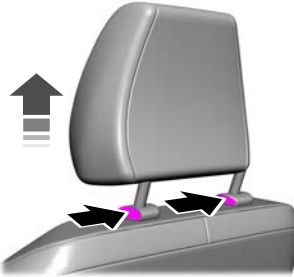

E251772

2. Press the locking buttons together.
3. Lift and remove the head restraint.

Rear Head Restraints

1. Fold the seat backrest forward so that there is enough room for you to remove the head restraint.

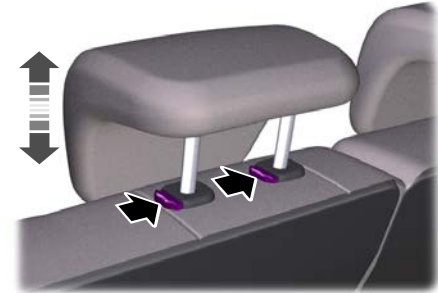

E135401

2. Press the locking buttons together.
3. Lift and remove the head restraint.

MANUAL SEATS - 3-DOOR

 **WARNING:** Do not adjust the driver seat when your vehicle is moving.

Seats

WARNING: Do not place cargo or any objects behind the seat backrest before returning it to the original position. Pull on the seat backrest to make sure that it has fully latched after returning the seat backrest to its original position. An unlatched seat may become dangerous if you stop suddenly or have a crash.

Moving the Seat Backward and Forward

WARNING: Make sure the seat fully locks into place by rocking it backward and forward. Not securing the seat into the locked position can be dangerous in a crash and could cause serious personal injury or death.

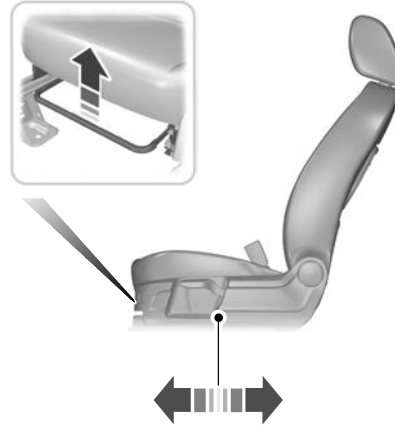

E147926

Note: Do not move the seat backward and forward using the lever underneath the seat base unless the seat backrest is upright.

Folding the Seat Backrest Forward



E159979

1. Pull the lever to release the seat backrest.

Note: Do not hold onto the lever when moving the seat.

2. Fold the seat backrest fully forward.

3. Slide the seat forward.

Seats

Returning the Seat Backrest to the Seating Position



E159980

1. Push the seat backrest to slide the tilted seat to the end stop (memory position) or desired seating position.
2. Fold the seat backrest to the upright position.

Note: Make sure the seat base has been moved to the correct position before folding the seat backrest upright.

Note: You do not need to pull the lever when unfolding the seat backrest.

Adjusting the Lumbar Support (if Equipped)



E249179

Adjusting the Height of the Driver Seat

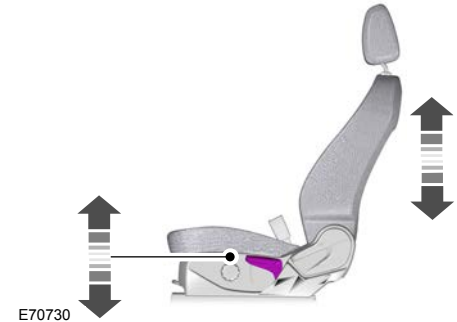

E70730

Seats

Recline Adjustment

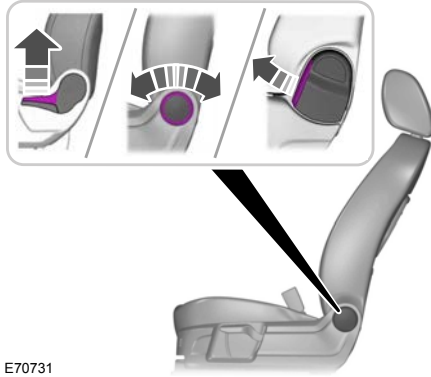

E70731

MANUAL SEATS - 5-DOOR

⚠ WARNING: Do not adjust the driver seat when your vehicle is moving.

Moving the Seat Backward and Forward

⚠ WARNING: Make sure the seat fully locks into place by rocking it backward and forward. Not securing the seat into the locked position can be dangerous in a crash and could cause serious personal injury or death.

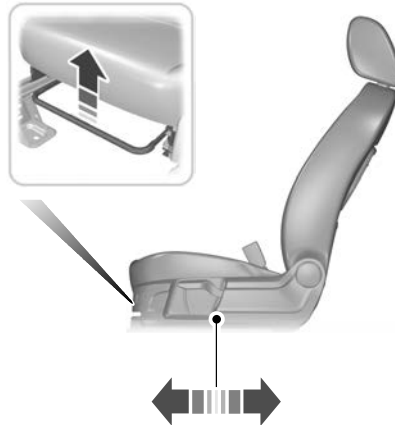

E147926

Adjusting the Lumbar Support (if

Equipped)



E249179

Seats

Adjusting the Height of the Driver Seat

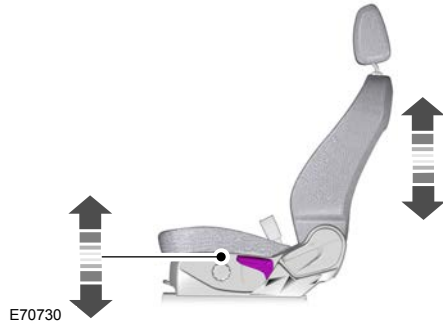

Recline Adjustment

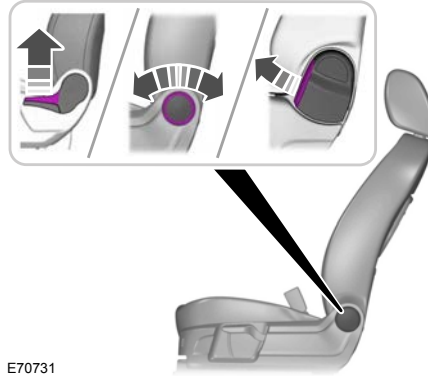

REAR SEATS

Folding the Seat Backrest

 **WARNING:** When folding the seat backrest down, take care not to get your fingers caught in the mechanism.

1. Lower the head restraints.



2. Press and hold the unlock buttons.
3. Push the seat backrest forward.

Note: Do not attempt to fold the rear seat cushion forward.

Seats

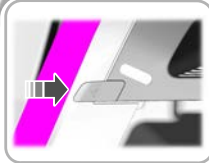
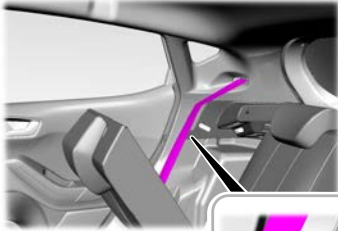

E249321

4. Place the seatbelts in the clips on the outermost trim.

Note: Make sure that the seatbelt is fully tightened into the retractor.

Unfolding the Seat Backrest

WARNING: When unfolding the seat backrests, make sure that the seatbelts are not trapped behind the seat.

WARNING: Make sure that the seats and the seat backrests are secure and fully locked in their catches.

HEATED SEATS

WARNING: Use caution when using the heated seat if you are unable to feel pain to your skin because of advanced age, chronic illness, diabetes, spinal cord injury, medication, alcohol use, exhaustion or other physical conditions. The heated seat could cause burns even at low temperatures, especially if used for long periods of time. Failure to follow this instruction could result in personal injury.

WARNING: Do not place anything on the seat that blocks the heat, for example a seat cover or a cushion. This could cause the seat to overheat. Failure to follow this instruction could result in personal injury.

WARNING: Do not poke sharp objects into the seat cushion or seat backrest. This could damage the heated seat element and cause it to overheat. Failure to follow this instruction could result in personal injury.

Do not switch the heated seat on if the seat is wet.

The heated seat button is on the climate control assembly.



Repeatedly press the button to adjust the temperature.

Rear Occupant Alert System (If Equipped)

WHAT IS THE REAR OCCUPANT ALERT SYSTEM

The rear occupant alert system monitors vehicle conditions and notifies you to check for rear seat occupants when you switch the ignition off.

HOW DOES THE REAR OCCUPANT ALERT SYSTEM WORK

The system monitors when rear doors have been opened and closed to indicate the potential presence of an occupant in the rear seat.

A message displays in the information and entertainment display screen and an audible warning sounds when you switch the ignition off after any of the following conditions have been met:

- A rear door is opened or closed while the ignition is on.
- You switch the ignition on within 15 minutes of a rear door opening and closing.
- You switch the ignition on within 15 minutes of the alert having displayed or sounded.

REAR OCCUPANT ALERT SYSTEM PRECAUTIONS



WARNING: On hot days, the temperature inside the vehicle can rise very quickly. Exposure of people or animals to these high temperatures for even a short time can cause death or serious heat related injuries, including brain damage. Small children are particularly at risk.



WARNING: Do not leave children or pets unattended in your vehicle. Failure to follow this instruction could result in personal injury or death.

REAR OCCUPANT ALERT SYSTEM LIMITATIONS

The system does not detect the presence of objects or passengers in the rear seat. It monitors when rear doors are opened and closed.

Note: *It is possible to receive an alert when there is no rear seat occupant, but alert conditions are met.*

Note: *It is possible to receive no alert when there is an occupant in the rear seat, if alert conditions are not met. For example, if a rear seat occupant does not enter the vehicle through a rear door.*

Note: *The audible warning does not sound when the front door is opened before you switch the ignition off.*

Rear Occupant Alert System (If Equipped)

SWITCHING REAR OCCUPANT ALERT SYSTEM ON AND OFF

1. Press **Settings** on the touchscreen.
2. Press **Vehicle**.
3. Switch **Rear Occupant Alert** on or off.

Note: The default setting is on.

Note: Performing a master reset causes the system to switch on again.

Semiannual Reminder (If Equipped)

When you switch the system off, a message appears every six months as a reminder that the system is off. You can switch the system back on or leave it off.

REAR OCCUPANT ALERT SYSTEM INDICATORS



Message
Check rear seats for occupants.

Displays when you switch your vehicle off after the alert conditions are met.

The message displays for a short period of time. Press **Close** to acknowledge and remove the message.

REAR OCCUPANT ALERT SYSTEM AUDIBLE WARNINGS

Sounds when you switch your vehicle off after the alert conditions are met.

The warning sounds for a short period of time.

Auxiliary Power Points

 **WARNING:** Do not plug optional electrical accessories into the cigar lighter socket. Incorrect use of the cigar lighter can cause damage not covered by the vehicle warranty, and can result in fire or serious injury.

 **WARNING:** Do not use a power point for operating a cigar lighter. Incorrect use of the power points can cause damage not covered by the vehicle warranty, and can result in fire or serious injury.

To prevent the battery from running out of charge:

- Do not use the power point longer than necessary when the vehicle is not running.
- Do not leave devices plugged in overnight or when you park your vehicle for extended periods.

Power points may be in the following locations:

- On the center console.
- Inside the center console.
- On the rear of the center console.
- Inside the luggage compartment.

CIGAR LIGHTER

 **WARNING:** Do not plug optional electrical accessories into the cigar lighter socket. Incorrect use of the cigar lighter can cause damage not covered by the vehicle warranty, and can result in fire or serious injury.

Do not hang any accessory from the accessory plug.

Do not use the power point over the vehicle capacity of 12 volt DC 180 watts or a fuse may blow.

Keep the power point caps closed when not in use.

Do not insert objects other than an accessory plug into the power point.

You can use the power point for up to 30 minutes after you switch the ignition off.

Note: When you switch the ignition on, you can use the socket to power 12 volt appliances with a maximum current rating of 15 amps.

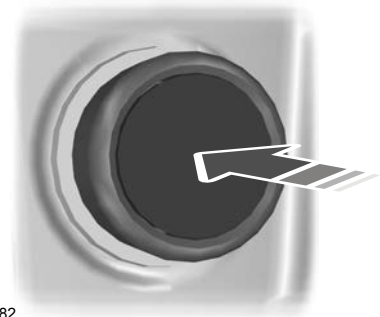

E103382

Press the element in to use the cigar lighter. It pops out after a short period of time.

Do not hold the cigar lighter element pressed in.

Note: If the power supply does not work after you switch the ignition off, switch the ignition on.

Note: If you use the socket when the engine is not running, the battery may run out of charge.

Note: When you switch the ignition on, you can use the socket to power 12 volt appliances with a maximum current rating of 15 amps.

Wireless Accessory Charger

LOCATING THE WIRELESS ACCESSORY CHARGER



The charging area is below the climate control.



CHARGING A WIRELESS DEVICE



WARNING: Wireless charging devices can affect the operation of implanted medical devices, including cardiac pacemakers. If you have any implanted medical devices, we recommend that you consult with your physician.

Place the device within the area shown and with the charging side down to begin charging. The charging stops after your device reaches a full charge.

Make sure the charging area is clean and free from obstruction before charging a device to allow the device to lay flat on the charging area.

The system supports one wireless charging compatible device on the charging area.

Note: *Placing the device outside the area shown could affect the charging process.*

Note: *Charging time and temperature are dependent on the device used. The system stops charging the device if it reaches a high temperature.*

Note: *Devices without built-in Qi standards for wireless charging require an additional Qi receiver or sleeve.*

Note: *For compatible devices with built-in Qi wireless charging capability, the charging performance may be affected if your device is in a case. It may be necessary to remove the case to wirelessly charge your device.*

Note: *Software and firmware updates to your device could affect the charging operation.*

Do not place items with a magnetic strip, for example passports, parking tickets or credit cards near the charging area when charging a device. This could damage the magnetic strip.

Do not place metal objects, for example remote controls, coins or keys on or near the charging area when charging a device. Metal objects may heat up and degrade the charging performance.

Wireless Accessory Charger

WIRELESS ACCESSORY CHARGER INDICATORS

Indicator LED	Description
Green	Your device is fully charged.
Yellow	Your device is charging.
Flashing yellow	The system detects an obstruction on the charging area. Remove the obstruction or place your device in the correct position on the charging area.

Note: *Due to different wireless charging standards, some devices may not indicate to the wireless charging system that they are fully charged. Therefore the LED indicator does not turn to green.*

Storage Compartments

CUP HOLDERS

Note: Stow items in the cupholder carefully as items may become loose during hard braking, acceleration or crashes, including hot drinks which may spill.



WARNING: Use only soft cups in the cup holders. Hard objects can injure you in a crash.

DEVICE HOLDER

Installing the Device Holder

1. Remove the cap from the rear of the audio unit.
2. Attach the device holder to the rear of the audio unit and press down until a click sounds.

Removing the Device Holder

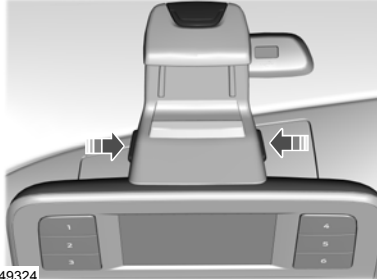

1. Press the locking buttons together and remove the device holder.
2. Attach the cap to the rear of the audio unit.

Installing a Device

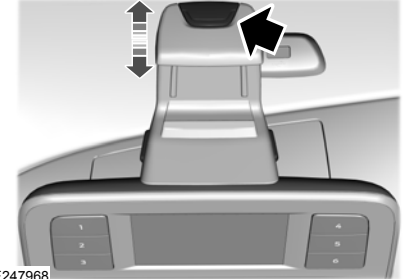

1. Press the button to unlock the clamp.
2. Place the device on the lower rubber mat.
3. Adjust the lid to secure the device.
4. Press the button again to lock the clamp.

Note: Do not leave a device in the device holder when leaving your vehicle.

Removing a Device

1. Press the button to unlock the clamp.
2. Lift the lid.
3. Remove the device from the device holder.
4. Press the button again to lock the clamp.

Starting and Stopping the Engine

STARTING AND STOPPING THE ENGINE – PRECAUTIONS

WARNING: Exhaust leaks may result in entry of harmful and potentially lethal fumes into the passenger compartment. If you smell exhaust fumes inside your vehicle, have your vehicle inspected immediately. Do not drive if you smell exhaust fumes.

WARNING: Extended idling at high engine speeds can produce very high temperatures in the engine and exhaust system, creating the risk of fire or other damage.

WARNING: Do not park, idle or drive your vehicle on dry grass or other dry ground cover. The emission system heats up the engine compartment and exhaust system, creating the risk of fire.

WARNING: Do not start the engine in a closed garage or in other enclosed areas. Exhaust fumes are toxic. Always open the garage door before you start the engine. Failure to follow this instruction could result in personal injury or death.

If you stop your vehicle and then leave the engine idling for long periods, we recommend that you do one of the following:

- Open the windows at least 3 cm (1 in).
- Set your climate control to outside air.

IGNITION SWITCH



E247596

Note: Make sure the key is clean before inserting it into any lock cylinder.

Note: Do not leave the key in the ignition for an extended period of time when the engine is not running. This is to prevent the vehicle battery from losing charge.

Switching the Ignition Off

Turn the key to position **0**.

Switching the Ignition to Accessory Mode

Turn the key to position **I**. Electrical accessories, for example the radio, operate without the engine running.

Switching the Ignition On

Turn the key to position **II**. All electrical circuits and accessories are operational and the warning lamps and indicators illuminate.

Starting the Engine

Turn the key to position **III**. Release the key when the engine starts.

Starting and Stopping the Engine

PUSH BUTTON IGNITION SWITCH



Switching the Ignition Off

When the ignition is on or in accessory mode, press the push button ignition switch once without your foot on the brake or clutch pedal.

Switching the Ignition to Accessory Mode

When the ignition is off, press the push button ignition switch once without your foot on the brake or clutch pedal.

All electrical circuits and accessories are operational and the warning lamps and indicators illuminate.

Starting the Engine

Press the brake or clutch pedal and press the push button ignition switch. An indicator light on the button illuminates when the ignition is on and when the engine starts.

Note: The system may not function if the passive key is close to metal objects or electronic devices, for example keys or a cell phone.

Note: A valid key must be inside your vehicle to switch the ignition on and start the engine.

STARTING THE ENGINE

Starting a Gasoline Engine - Automatic Transmission, Vehicles Without: Push Button Start

Before starting your vehicle, check the following:

- Make sure that the headlamps and electrical accessories are off.
- Make sure that the parking brake is on.
- Make sure that the transmission is in park (P).

1. Fully press the brake pedal.

Note: Do not touch the accelerator pedal.



2. Turn the key to position **III**.

Note: The engine may continue cranking for up to 15 seconds or until it starts.

Note: The engine takes longer to start at lower temperatures. It may crank for several seconds when very cold.

Starting a Gasoline Engine - Automatic Transmission, Vehicles With: Push Button Start

Before starting your vehicle, check the following:

- Make sure that the headlamps and electrical accessories are off.
- Make sure that the parking brake is on.
- Make sure that the transmission is in park (P).

1. Fully press the brake pedal.

Note: Do not touch the accelerator pedal.

Starting and Stopping the Engine



2. Press the push button ignition switch.

Note: The engine may continue cranking for up to 15 seconds or until it starts.

Note: The engine takes longer to start at lower temperatures. It may crank for several seconds when very cold.

Starting a Gasoline Engine - Manual Transmission, Vehicles Without: Push Button Start

Before starting your vehicle, check the following:

- Make sure that the headlamps and electrical accessories are off.
- Make sure that the parking brake is on.
- Make sure that the transmission is in neutral.

1. Fully press the clutch pedal.

Note: Do not touch the accelerator pedal.



2. Turn the key to position III.

Note: The engine may continue cranking for up to 15 seconds or until it starts.

Note: The engine takes longer to start at lower temperatures. It may crank for several seconds when very cold.

Starting a Gasoline Engine - Manual Transmission, Vehicles With: Push Button Start

Before starting your vehicle, check the following:

- Make sure that the headlamps and electrical accessories are off.
- Make sure that the parking brake is on.
- Make sure that the transmission is in neutral.

1. Fully press the clutch pedal.

Note: Do not touch the accelerator pedal.



2. Press the push button ignition switch.

Note: The engine may continue cranking for up to 15 seconds or until it starts.

Note: The engine takes longer to start at lower temperatures. It may crank for several seconds when very cold.

Starting a Diesel Engine - Vehicles Without: Push Button Start

Before starting your vehicle, check the following:

- Make sure that the headlamps and electrical accessories are off.
- Make sure that the parking brake is on.
- Make sure that the transmission is in neutral.



Starting and Stopping the Engine

1. Turn the key to position **II**.

Note: Wait until the glow plug indicator turns off.

2. Fully press the clutch pedal.

Note: Do not touch the accelerator pedal.



3. Turn the key to position **III**.

Note: The engine may continue cranking for up to 15 seconds or until it starts.

Note: The engine takes longer to start at lower temperatures. It may crank for several seconds when very cold.

Glow Plug Indicator



If it illuminates, wait until the glow plug indicator turns off before starting the engine.

Starting a Diesel Engine - Vehicles With: Push Button Start

Before starting your vehicle, check the following:

- Make sure that the headlamps and electrical accessories are off.
- Make sure that the parking brake is on.
- Make sure that the transmission is in neutral.

1. Fully press the clutch pedal.

Note: Do not touch the accelerator pedal.



2. Press the push button ignition switch.

Note: The engine may continue cranking for up to 15 seconds or until it starts.

Note: The engine takes longer to start at lower temperatures. It may crank for several seconds when very cold.

Glow Plug Indicator



The engine does not start until the glow plug indicator turns off. This may take several seconds in extremely cold conditions.

Restarting the Engine After Stopping it

The system allows you to start the engine within 10 seconds of switching it off, even if it does not detect a valid passive key.

Within 10 seconds of switching the engine off, fully press the brake or clutch pedal and press the push button ignition switch. After 10 seconds, you can no longer start the engine if the system does not detect a valid passive key.

When you start the engine, it remains running until you press the push button ignition switch, even if your vehicle does not detect a valid passive key. If you open and close a door when the engine is running, the system searches for a valid passive key.

Starting and Stopping the Engine

ENGINE BLOCK HEATER

Engine Block Heater Precautions



WARNING: Failure to follow engine block heater instructions could result in property damage or serious personal injury.



WARNING: Do not fully close the hood, or allow it to drop under its own weight when using the engine block heater. This could damage the power cable and may cause an electrical short resulting in fire, injury and property damage.



WARNING: Do not use your heater with ungrounded electrical systems or two-pronged adapters. There is a risk of electrical shock.

Make sure that you do the following:

- Use an extension cord suitable for outdoor use and in cold temperatures. It should be clearly marked that it is suitable for use with outdoor appliances. Do not use an indoor extension cord outdoors. This could result in an electric shock or become a fire hazard.
 - Use as short an extension cord as possible.
 - Do not use multiple extension cords.
 - Make sure that when in operation, the extension cord plug and engine block heater cord plug connections are free and clear of water. This could result in an electric shock or become a fire hazard.
 - Park your vehicle in a clean area, clear of combustible materials.
 - Firmly connect the engine block heater cord and the extension cord.
 - Check the extension cord for heat anywhere when the system has been operating for approximately 30 minutes.
 - Unplug and properly stow the system before starting and driving your vehicle.
- The protective cover seals the terminals of the engine block heater cord plug when not in use.
 - Check the engine block heater system for proper operation before winter.

How Does the Engine Block Heater Work

The engine block heater warms the engine coolant. This allows the climate control system to quickly respond. The equipment includes a heater element installed in the engine block and a wire harness. You can connect the system to a grounded 220-240 volt AC electrical source.

Note: *The engine block heater is most effective when the ambient temperature is below -18°C (0°F).*

Using the Engine Block Heater

The engine block heater plug may be found in one of the following locations:

- Under the hood.
- In the front fog lamp bezel.
- Front lower grille.

Starting and Stopping the Engine

Open the hinged cover and connect the engine block heater cord plug to an extension cord. See **Engine Block Heater Precautions** (page 162).

The engine block heater uses 0.4 to 1.0 kilowatt-hours of energy per hour of use. The system does not have a thermostat. It reaches maximum temperature after approximately three hours of operation. Using the engine block heater longer than three hours does not improve system performance and unnecessarily uses electricity.

STOPPING THE ENGINE

Stopping the Engine When Your Vehicle is Stationary - Manual Transmission, Vehicles Without: Push Button Start

1. Shift into neutral.
2. Apply the parking brake.
3. Wait until the engine reaches idle speed.

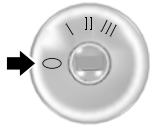

4. Turn the key to position **0**.

Stopping the Engine When Your Vehicle is Stationary - Manual Transmission, Vehicles With: Push Button Start

1. Shift into neutral.
2. Apply the parking brake.
3. Wait until the engine reaches idle speed.



4. Press the push button ignition switch.

Stopping the Engine When Your Vehicle is Stationary - Automatic Transmission, Vehicles Without: Push Button Start

1. Shift into park (P).
2. Apply the parking brake.
3. Wait until the engine reaches idle speed.

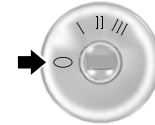

4. Turn the key to position **0**.

Stopping the Engine When Your Vehicle is Stationary - Automatic Transmission, Vehicles With: Push Button Start

1. Shift into park (P).
2. Apply the parking brake.
3. Wait until the engine reaches idle speed.



4. Press the push button ignition switch.

Starting and Stopping the Engine

Stopping the Engine When Your Vehicle is Moving - Manual Transmission, Vehicles Without: Push Button Start

 **WARNING:** Switching off the engine when your vehicle is still moving results in a significant decrease in braking assistance. Higher effort is required to apply the brakes and to stop your vehicle. A significant decrease in steering assistance could also occur. The steering does not lock, but higher effort could be required to steer your vehicle. When you switch the ignition off, some electrical circuits, for example airbags, also turn off. If you unintentionally switch the ignition off, shift into neutral (N) and restart the engine.

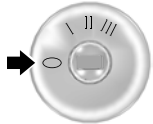

1. Turn the key to position **O**.
2. Shift into neutral and use the brakes to bring your vehicle to a safe stop.
3. Apply the parking brake.

Stopping the Engine When Your Vehicle is Moving - Manual Transmission, Vehicles With: Push Button Start

 **WARNING:** Switching off the engine when your vehicle is still moving results in a significant decrease in braking assistance. Higher effort is required to apply the brakes and to stop your vehicle. A significant decrease in steering assistance could also occur. The steering does not lock, but higher effort could be required to steer your vehicle. When you switch the ignition off, some electrical circuits, for example airbags, also turn off. If you unintentionally switch the ignition off, shift into neutral (N) and restart the engine.



1. Press and hold the push button ignition switch until the engine stops, or press it three times within two seconds.

2. Shift into neutral and use the brakes to bring your vehicle to a safe stop.
3. Apply the parking brake.

Stopping the Engine When Your Vehicle is Moving - Automatic Transmission, Vehicles Without: Push Button Start

 **WARNING:** Switching off the engine when your vehicle is still moving results in a significant decrease in braking assistance. Higher effort is required to apply the brakes and to stop your vehicle. A significant decrease in steering assistance could also occur. The steering does not lock, but higher effort could be required to steer your vehicle. When you switch the ignition off, some electrical circuits, for example airbags, also turn off. If you unintentionally switch the ignition off, shift into neutral (N) and restart the engine.

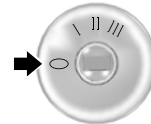

Starting and Stopping the Engine

1. Turn the key to position **0**.
2. Shift into neutral and use the brakes to bring your vehicle to a safe stop.
3. Shift into park (P).
4. Apply the parking brake.

Stopping the Engine When Your Vehicle is Moving - Automatic Transmission, Vehicles With: Push Button Start



WARNING: Switching off the engine when your vehicle is still moving results in a significant decrease in braking assistance. Higher effort is required to apply the brakes and to stop your vehicle. A significant decrease in steering assistance could also occur. The steering does not lock, but higher effort could be required to steer your vehicle. When you switch the ignition off, some electrical circuits, for example airbags, also turn off. If you unintentionally switch the ignition off, shift into neutral (N) and restart the engine.



1. Press and hold the push button ignition switch until the engine stops, or press it three times within two seconds.
2. Shift into neutral and use the brakes to bring your vehicle to a safe stop.
3. Shift into park (P).
4. Apply the parking brake.

AUTOMATIC ENGINE STOP

How Does Automatic Engine Stop Work

Automatic engine stop automatically shuts down the vehicle if it has been idling for an extended period. The ignition also turns off to save battery power. Before your vehicle shuts down, a message appears in the information display showing a timer counting down. If you do not intervene within 30 seconds, your vehicle shuts down. Another message appears in the information display to inform you that your vehicle has shut down to save fuel. Start your vehicle as normal.

Switching Automatic Engine Stop On and Off

1. Using the information display controls on the steering wheel, select **Settings**.
2. Select **Vehicle settings**.
3. Switch **30min max idle** on or off.

Note: You cannot permanently switch off the automatic shutdown. If you switch it off, it turns on each time you switch the ignition on.

Starting and Stopping the Engine

Overriding Automatic Engine Stop

You can stop the shutdown, or reset the timer, at any point before the 30-second countdown has expired by doing any of the following:

- Pressing the brake or accelerator pedal.
- Pressing the **OK** or **RESET** button during the 30-second countdown.

STARTING AND STOPPING THE ENGINE – TROUBLESHOOTING

Starting and Stopping the Engine – Warning Lamps



Malfunction Indicator Lamp
Check Engine

If it illuminates when the engine is running this indicates a malfunction. The On Board Diagnostics system has detected a malfunction of the vehicle emission control system.

If it flashes, engine misfire may be occurring. Increased exhaust gas temperatures could damage the catalytic converter or other vehicle components. Avoid heavy acceleration and deceleration and have your vehicle immediately serviced.



Powertrain Warning Lamp

If it illuminates when the engine is running this indicates a malfunction. If it flashes when you are driving, immediately reduce the vehicle speed. Avoid heavy acceleration and deceleration and have your vehicle immediately serviced.

If both lamps illuminate when the engine is running, stop your vehicle as soon as it is safe to do so. Continuing to drive your vehicle may cause reduced power or the engine to stop. Switch the ignition off and attempt to restart the engine. Have your vehicle immediately checked.

Starting and Stopping the Engine

Starting and Stopping the Engine – Information Messages

Message	Action
Cranking time exceeded	Displays if you exceed the starting time limit. You cannot attempt to start the engine for 15 minutes. If you cannot start the engine after 15 minutes passes, have your vehicle immediately checked.
Starting system malfunction	Displays if you are unable to start your vehicle with a correctly coded key. The system has detected a fault that requires service. Have your vehicle checked as soon as possible.
No key detected	Displays if the system does not detect a valid passive key.

Starting and Stopping the Engine

Starting and Stopping the Engine – Frequently Asked Questions - Gasoline, Vehicles Without: Push Button Start

Why is the engine idle speed high when I am starting the engine?

The speed at which the engine idles immediately after starting is optimized to minimize vehicle emissions and maximize cabin comfort and fuel economy.

Why does the engine not crank?

You can only attempt to start the engine for a limited amount of time before the starting system temporarily disables. If you exceed the starting time limit, a message may appear and you cannot attempt to start the engine for at least 15 minutes.

Why do I experience different driving characteristics?

If you disconnect the battery, your vehicle may exhibit some unusual driving characteristics for approximately 8 km (5 mi) after you reconnect it. This is because the engine management system must realign itself with the engine. You can disregard any unusual driving characteristics during this period.

Why can I not start the engine?

If you cannot start the engine after 3 attempts, wait 10 seconds and do the following:

1. Fully press the brake pedal or the clutch pedal.

Note: Make sure that the parking brake is applied.

Note: Make sure that the transmission is in park (P) or neutral (N).

2. Fully press the accelerator pedal and hold it there.



3. Turn the key to position **III** and wait until the engine stops cranking.
4. Release the accelerator pedal.
5. Turn the key to position **III**.

Starting and Stopping the Engine – Frequently Asked Questions - Gasoline, Vehicles With: Push Button Start

Why is the engine idle speed high when I am starting the engine?

The speed at which the engine idles immediately after starting is optimized to minimize vehicle emissions and maximize cabin comfort and fuel economy.

Why does the engine not crank?

You can only attempt to start the engine for a limited amount of time before the starting system temporarily disables. If you exceed the starting time limit, a message may appear and you cannot attempt to start the engine for at least 15 minutes.

Starting and Stopping the Engine

Why do I experience different driving characteristics?

If you disconnect the battery, your vehicle may exhibit some unusual driving characteristics for approximately 8 km (5 mi) after you reconnect it. This is because the engine management system must realign itself with the engine. You can disregard any unusual driving characteristics during this period.

Why can I not start the engine?

If you cannot start the engine after 3 attempts, wait 10 seconds and do the following:

1. Fully press the brake pedal or the clutch pedal.

Note: Make sure that the parking brake is applied.

Note: Make sure that the transmission is in park (P) or neutral (N).

2. Fully press the accelerator pedal and hold it there.
3. Press the push button ignition switch.

Note: The engine cranks for a short period of time and then it stops.

4. Release the accelerator pedal.



5. Press the push button ignition switch.

Why does the system not detect a passive key?

If the system does not detect a passive key and you are unable to start the engine, insert the passive key into the backup position and press the push button ignition switch to start the engine. See **Passive Key Backup Position** (page 58).

Starting and Stopping the Engine – Frequently Asked Questions - Diesel, Vehicles Without: Push Button Start

Why is the engine idle speed high when I am starting the engine?

The speed at which the engine idles immediately after starting is optimized to minimize vehicle emissions and maximize cabin comfort and fuel economy.

Why does the engine not crank?

You can only attempt to start the engine for a limited amount of time before the starting system temporarily disables. If you exceed the starting time limit, a message may appear and you cannot attempt to start the engine for at least 15 minutes.

Why do I experience different driving characteristics?

If you disconnect the battery, your vehicle may exhibit some unusual driving characteristics for approximately 8 km (5 mi) after you reconnect it. This is because the engine management system must realign itself with the engine. You can disregard any unusual driving characteristics during this period.

Why can I not start the engine?

If you cannot start the engine, do the following:

1. Fully press the brake pedal or the clutch pedal.

Note: Make sure that the parking brake is applied.

Note: Make sure that the transmission is in park (P) or neutral (N).

Starting and Stopping the Engine



2. Turn the key to position III until the engine starts.

Starting and Stopping the Engine – Frequently Asked Questions - Diesel, Vehicles With: Push Button Start

Why is the engine idle speed high when I am starting the engine?

The speed at which the engine idles immediately after starting is optimized to minimize vehicle emissions and maximize cabin comfort and fuel economy.

Why does the engine not crank?

You can only attempt to start the engine for a limited amount of time before the starting system temporarily disables. If you exceed the starting time limit, a message may appear and you cannot attempt to start the engine for at least 15 minutes.

Why do I experience different driving characteristics?

If you disconnect the battery, your vehicle may exhibit some unusual driving characteristics for approximately 8 km (5 mi) after you reconnect it. This is because the engine management system must realign itself with the engine. You can disregard any unusual driving characteristics during this period.

Why can I not start the engine?

If you cannot start the engine, do the following:

1. Fully press the brake pedal or the clutch pedal.

Note: Make sure that the parking brake is applied.

Note: Make sure that the transmission is in park (P) or neutral (N).



2. Press the push button ignition switch until the engine starts.

Why does the system not detect a passive key?

If the system does not detect a passive key and you are unable to start the engine, insert the passive key into the backup position and press the push button ignition switch to start the engine. See **Passive Key Backup Position** (page 58).

Unique Driving Characteristics

AUTO-START-STOP - MANUAL TRANSMISSION, EXCLUDING: MILD HYBRID ELECTRIC VEHICLE (MHEV)



WARNING: Apply the parking brake, shift into neutral, switch the ignition off and remove the key before you open the hood or have any service or repair work completed. If you do not switch the ignition off, the engine could restart at any time. Failure to follow this instruction could result in personal injury or death.

Principle of Operation

The system is designed to help reduce fuel consumption and CO₂ emissions by stopping the engine when it is idling, for example at traffic lights. Your vehicle has an enhanced battery and starter motor that are designed for an increased number of engine starts.

The system does not stop the engine under certain conditions, for example:

- If you have opened the driver door.
- If you have unfastened the driver seatbelt.
- If your vehicle is at high altitude.

- If you have switched the heated windshield on.
- If the engine is warming up.
- If the outside temperature is too low or too high.
- If the battery charge is low or the battery temperature is outside the optimal operating range.
- To maintain the interior climate or reduce fogging.

The system restarts the engine under certain conditions, for example:

- If you switch the heated windshield on.
- If you switch maximum defrost on.
- If your vehicle starts to roll downhill in neutral.
- To maintain adequate brake assistance.
- To maintain the interior climate or reduce fogging.

Note: *The blower motor speed could change when the system restarts the engine.*

Using Auto-Start-Stop

Stopping the Engine

1. Stop your vehicle.
2. Shift into neutral.

3. Release the clutch pedal.

Note: *Power assist steering turns off when the engine is off.*

Restarting the Engine

Fully press the clutch pedal.

Note: *To obtain maximum benefit from the system, shift into neutral and release the clutch pedal whenever you stop your vehicle for more than three seconds.*

Note: *The system provides stall recovery. To restart the engine after stalling, fully press the clutch pedal.*

Switching the System On and Off



The system turns on when you switch the ignition on. Press the switch to switch it off.

Note: **OFF** illuminates in the switch.

Press the switch again to switch the system back on.

The auto-start-stop indicator illuminates green when the engine stops. It flashes amber and a message appears when you need to take an action.



The auto-start stop indicator illuminates grey with a strike out when the system is not available.

Unique Driving Characteristics

Note: The system turns off when it detects a malfunction. If it remains off, have your vehicle checked as soon as possible.

Auto-Start-Stop Warning

Sounds when you open the driver door and the system has stopped the engine.

Information Messages

Message	Condition	Action
Auto StartStop Press a pedal to start engine	The system needs to restart the engine but requires your confirmation.	Press the accelerator pedal, brake pedal or clutch pedal.
Auto StartStop Manual restart required	The system is not functioning.	Restart the engine.
Auto StartStop Select neutral to start engine	The system needs to restart the engine but cannot because the transmission is in gear.	Shift into neutral and restart the engine.

Replacing the Battery

Replace the battery with one of exactly the same specification for the system to function correctly.

AUTO-START-STOP - AUTOMATIC TRANSMISSION



WARNING: Apply the parking brake, shift into neutral, switch the ignition off and remove the key before you open the hood or have any service or repair work completed. If you do not switch the ignition off, the engine could restart at any time. Failure to follow this instruction could result in personal injury or death.

Principle of Operation

The system is designed to help reduce fuel consumption and CO₂ emissions by stopping the engine when it is idling, for example at traffic lights. Your vehicle has an enhanced battery and starter motor that are designed for an increased number of engine starts.

The system does not stop the engine under certain conditions, for example:

- If you have opened the driver door.
- If you have unfastened the driver seatbelt.
- If your vehicle is at high altitude.

Unique Driving Characteristics

- If you have switched the heated windshield on.
- If your vehicle is on a steep grade.
- If the engine is warming up.
- If the outside temperature is too low or too high.
- If the battery charge is low or the battery temperature is outside the optimal operating range.
- To maintain the interior climate or reduce fogging.

The system restarts the engine under certain conditions, for example:

- If you have opened the driver door.
- If you have unfastened the driver seatbelt.
- If you switch the heated windshield on.
- If you switch maximum defrost on.
- If your vehicle starts to roll downhill in neutral.
- To maintain adequate brake assistance.
- To maintain the interior climate or reduce fogging.

Note: *The blower motor speed could change when the system restarts the engine.*

Using Auto-Start-Stop

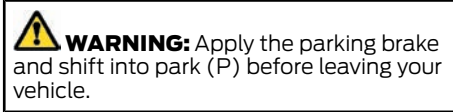

Stopping the Engine

Stop your vehicle and keep your foot on the brake pedal and the transmission in drive (D).

Note: *The engine stops if you shift into park (P) or neutral (N) regardless of whether you have your foot on the brake pedal or not.*

Note: *Power assist steering turns off when the engine is off.*

Restarting the Engine

- Release the brake pedal.
- Press the accelerator pedal.
- Shift into drive (D), reverse (R) or sport (S).

Switching the System On and Off



The system turns on when you switch the ignition on. Press the switch to switch it off.

Note: *OFF illuminates in the switch.*

Press the switch again to switch the system back on.

The auto-start-stop indicator illuminates green when the engine stops. It flashes amber and a message appears when you need to take an action.



The auto-start stop indicator illuminates grey with a strike out when the system is not available.

Note: *The system turns off when it detects a malfunction. If it remains off, have your vehicle checked as soon as possible.*

Unique Driving Characteristics

Information Messages

Message	Condition	Action
Auto StartStop Press brake to start engine	The system needs to restart the engine but requires your confirmation.	Press the brake pedal to restart the engine.
Auto StartStop Shift to P Restart engine	The system is not functioning.	Shift into park (P) and restart the engine yourself.

Replacing the Battery

Replace the battery with one of exactly the same specification for the system to function correctly.

HYBRID VEHICLE OPERATION

Your vehicle has a 48 volt mild hybrid system. The system is designed to help reduce fuel consumption and CO₂ emissions by using regenerative charging and stopping the engine when your vehicle is coasting at a speed less than the engine stop speed that you have set. See **Setting the Engine Stop Speed** (page 175).

Note: *Regenerative charging results in a greater degree of engine braking. Engine braking further increases following a brake pedal press. This is normal.*

Auto-Start-Stop - Mild Hybrid Electric Vehicle (MHEV), Manual Transmission

WHAT IS AUTO-START-STOP

The system is designed to help reduce fuel consumption and CO₂ emissions by stopping the engine when it is idling, for example at traffic lights or when your vehicle is coasting at a speed less than the engine stop speed that you have set. See **Setting the Engine Stop Speed** (page 175). The system is designed to stop the engine when the transmission is in gear or in neutral.

AUTO-START-STOP PRECAUTIONS



WARNING: Apply the parking brake, shift into neutral, switch the ignition off and remove the key before you leave your vehicle. Failure to follow this instruction could result in personal injury or death.



WARNING: Apply the parking brake, shift into neutral, switch the ignition off and remove the key before you open the hood or have any service or repair work completed. If you do not switch the ignition off, the engine could restart at any time. Failure to follow this instruction could result in personal injury or death.

AUTO-START-STOP SETTINGS

Setting the Engine Stop Speed

1. Using the information display controls on the steering wheel, select **Settings**.
2. Select **Vehicle settings**.
3. Select **Rolling StartStop**.
4. Select a setting and press the **OK** button.

SWITCHING AUTO-START-STOP ON AND OFF

The system turns on when you switch the ignition on.



Press the switch to switch the system off.

Note: **OFF** illuminates in the switch.

Press the switch again to switch the system back on.

Note: *The system is designed to turn off if it detects a malfunction. If the system malfunctions, have your vehicle checked as soon as possible.*

STOPPING THE ENGINE

Stopping the Engine in Gear

1. Press the brake pedal and slow your vehicle down to 15 km/h (9 mph) or less.

Note: *You can set the speed at which the system stops the engine through the information display.*

2. Fully press the clutch pedal.

Note: *Power assist steering remains on when the engine stops.*

Stopping the Engine in Neutral

1. Press the brake pedal and slow your vehicle down to 15 km/h (9 mph) or less.

Auto-Start-Stop - Mild Hybrid Electric Vehicle (MHEV), Manual Transmission

Note: You can set the speed at which the system stops the engine through the information display.

2. Press the clutch pedal and shift into neutral.
3. Release the clutch pedal.

Note: Power assist steering remains on when the engine stops.

RESTARTING THE ENGINE

Restarting the Engine in Gear

Release the brake pedal.

Restarting the Engine in Neutral

1. Fully press the clutch pedal.

2. Select a gear.

AUTO-START-STOP INDICATORS

 **WARNING:** The system may require the engine to automatically restart when the auto-start-stop indicator illuminates green or flashes amber. Failure to follow this instruction could result in personal injury.

 The Auto-Start-Stop indicator illuminates green when the engine stops. It flashes amber and a message appears when you need to take action.



The Auto-Start-Stop indicator illuminates gray with a strikethrough when the system is not available.

Note: You can display the reason why the system is not available in the information display.

AUTO-START-STOP AUDIBLE WARNING

The Auto-Start-Stop audible warning sounds if you open the driver door when the system has stopped the engine.

Auto-Start-Stop - Mild Hybrid Electric Vehicle (MHEV), Manual Transmission

AUTO-START-STOP – TROUBLESHOOTING

Auto-Start-Stop – Information Messages

Message	Condition	Action
Auto StartStop Manual restart required	The system is not functioning.	Shift into neutral and restart the engine yourself.
Auto StartStop Select neutral to start engine	The system cannot restart the engine.	Shift into neutral.
Auto StartStop Press clutch to start engine	The system cannot restart the engine.	Fully press the clutch pedal.

Auto-Start-Stop - Mild Hybrid Electric Vehicle (MHEV), Manual Transmission

Auto-Start-Stop – Frequently Asked Questions

Why does the engine not always stop when I expect it to?

The system is designed to work in a way that complements other vehicle systems, allowing them to operate at optimum performance.

The system does not stop the engine if:

- The driver door is open.
- The driver seatbelt is unfastened.
- The engine is warming up.
- The outside temperature is too low or too high.
- The battery charge is low.
- The battery temperature is outside the optimal operating range.
- The engine is required to run to maintain interior climate and reduce fogging.

Why does the engine sometimes restart when I do not expect it to?

The system is designed to work in a way that complements other vehicle systems, allowing them to operate at optimum performance.

The system restarts the engine if:

- You switch **MAX A/C** on.
- You switch maximum defrost on.
- Your vehicle starts to roll downhill in neutral.
- The engine is required to run to maintain adequate brake system assistance.
- The engine is required to run to maintain interior climate and reduce fogging.

Can I permanently switch the system off?

No. The system plays an important role in reducing the fuel consumption and the CO₂ emissions.

Will the frequent engine starts cause parts to wear out?

Your vehicle has an enhanced battery and starter generator that are designed for the increased number of engine starts.

Auto-Start-Stop - Mild Hybrid Electric Vehicle (MHEV), Automatic Transmission

WHAT IS AUTO-START-STOP

The system is designed to help reduce fuel consumption and CO₂ emissions by stopping the engine when it is idling, for example at traffic lights or when your vehicle is coasting at a speed of 15 km/h (9 mph) or less.

AUTO-START-STOP PRECAUTIONS



WARNING: Apply the parking brake, shift into park (P), switch the ignition off and remove the key before you leave your vehicle. Failure to follow this instruction could result in personal injury or death.



WARNING: Apply the parking brake, shift into park (P), switch the ignition off and remove the key before you open the hood or have any service or repair work completed. If you do not switch the ignition off, the engine could restart at any time. Failure to follow this instruction could result in personal injury or death.

SWITCHING AUTO-START-STOP ON AND OFF

The system turns on when you switch the ignition on.



Press the switch to switch the system off.

Note: **OFF** illuminates in the switch.

Press the switch again to switch the system back on.

Note: The system is designed to turn off if it detects a malfunction. If the system malfunctions, have your vehicle checked as soon as possible.

STOPPING THE ENGINE

With the vehicle in drive (D), press the brake pedal and slow the vehicle down to 12 km/h (7 mph) or less.

Note: The engine stops when you shift into park (P) whether you have your foot on the brake pedal or not.

Note: Power assist steering remains on when the engine stops.

RESTARTING THE ENGINE

Release the brake pedal or press the accelerator pedal.

A message appears in the information display if the system requires you to take action.

Auto-Start-Stop - Mild Hybrid Electric Vehicle (MHEV), Automatic Transmission

Message	Condition	Action
Auto StartStop Press brake to start engine	The system needs to restart the engine but requires your confirmation.	Press the brake pedal to restart the engine.
Auto StartStop Press a pedal to start engine	The system needs to restart the engine but requires your confirmation.	Press the brake pedal or the accelerator pedal to restart the engine.

Auto-Start-Stop - Mild Hybrid Electric Vehicle (MHEV), Automatic Transmission

AUTO-START-STOP INDICATORS



WARNING: The system may require the engine to automatically restart when the auto-start-stop indicator illuminates green or flashes amber. Failure to follow this instruction could result in personal injury.



The Auto-Start-Stop indicator illuminates green when the engine stops. It flashes amber and a message appears when you need to take action.



The Auto-Start-Stop indicator illuminates gray with a strikethrough when the system is not available.

Note: You can display the reason why the system is not available in the information display.

AUTO-START-STOP AUDIBLE WARNING

The Auto-Start-Stop audible warning sounds if you open the driver door when the system has stopped the engine.

AUTO-START-STOP – TROUBLESHOOTING

Auto-Start-Stop – Information Messages

Message	Condition	Action
Auto StartStop Shift to P Restart engine	The system is not functioning.	Shift into park (P) and restart the engine yourself.
Auto StartStop Manual restart required	The system is not functioning.	Restart the engine yourself.

Auto-Start-Stop – Frequently Asked Questions

Why does the engine not always stop when I expect it to?

The system is designed to work in a way that complements other vehicle systems, allowing them to operate at optimum performance.

The system does not stop the engine if:

- The driver door is open.
- The driver seatbelt is unfastened.
- The transmission is in manual (M) or Neutral (N).
- Your vehicle is on a steep grade.
- The engine is warming up.
- The outside temperature is too low or too high.
- The battery charge is low.
- The battery temperature is outside the optimal operating range.
- The engine is required to run to maintain interior climate and reduce fogging.

Why does the engine sometimes restart when I do not expect it to?

The system is designed to work in a way that complements other vehicle systems, allowing them to operate at optimum performance.

The system restarts the engine if:

- You switch **MAX A/C** on.
- You switch maximum defrost on.
- Your vehicle starts to roll downhill in neutral.
- You select Neutral (N).
- The engine is required to run to maintain adequate brake system assistance.
- The engine is required to run to maintain interior climate and reduce fogging.

Can I permanently switch the system off?

No. The system plays an important role in reducing the fuel consumption and the CO₂ emissions.

Will the frequent engine starts cause parts to wear out?

Your vehicle has an enhanced battery and starter generator that are designed for the increased number of engine starts.

Fuel and Refueling

SAFETY PRECAUTIONS

 **WARNING:** Do not overfill the fuel tank. The pressure in an overfilled tank may cause leakage and lead to fuel spray and fire.

 **WARNING:** The fuel system may be under pressure. If you hear a hissing sound near the fuel filler inlet, do not refuel until the sound stops. Otherwise, fuel may spray out, which could cause serious personal injury.

 **WARNING:** Fuels can cause serious injury or death if misused or mishandled.

 **WARNING:** Fuel may contain benzene, which is a cancer-causing agent.

 **WARNING:** When refueling always shut the engine off and never allow sparks or open flames near the fuel tank filler valve. Never smoke or use a cell phone while refueling. Fuel vapor is extremely hazardous under certain conditions. Avoid inhaling excess fumes.

Follow these guidelines when refueling:

- Extinguish all smoking materials and any open flames before refueling your vehicle.
- Always switch the engine off before refueling.
- Automotive fuels can be harmful or fatal if swallowed. Fuel is highly toxic and if swallowed can cause death or permanent injury. If fuel is swallowed immediately call a physician, even if no symptoms are immediately apparent. The toxic effects of fuel may not be apparent for hours.
- Avoid inhaling fuel vapors. Inhaling fuel vapor can lead to eye and respiratory tract irritation. In severe cases, excessive or prolonged breathing of fuel vapor can cause serious illness and permanent injury.
- Avoid getting fuel in your eyes. If you splash fuel in your eyes, immediately remove contact lenses (if worn), flush with water for 15 minutes and seek medical attention. Failure to seek proper medical attention could lead to permanent injury.

- Fuels can be harmful if absorbed through the skin. If you splash fuel on your skin, clothing or both, promptly remove contaminated clothing and thoroughly wash your skin with soap and water. Repeated or prolonged skin contact causes skin irritation.
- Be particularly careful if you are taking Antabuse or other forms of Disulfiram for the treatment of alcoholism. Breathing fuel vapors could cause an adverse reaction, serious personal injury or sickness. Immediately call a physician if you experience any adverse reactions.

FUEL QUALITY - E85

Choosing the Right Fuel - Flex Fuel Vehicles

 **WARNING:** Do not mix diesel with gasoline, gasohol or alcohol. This could cause an explosion.

Do not modify the fuel system configuration or the components in the system. Do not replace the fuel system or the components with parts not specially designed to be used with E85.

Fuel and Refueling

Use minimum 95 octane unleaded gasoline that meets the specification defined by EN 228 or the equivalent national specification, or regular unleaded gasoline blended with a maximum of 85% ethanol (E85).



Do not use any fuel other than those recommended because they could lead to engine damage that may not be covered by the vehicle Warranty.

Note: We recommend that you use only high quality fuel. Use of any fuel other than those recommended can impair the emission control system and cause a loss of vehicle performance.

Note: When using E85, your vehicle may have higher fuel consumption.

Do not use:

- Diesel fuel.
- Fuels containing methanol.

- Fuels containing kerosene or paraffin.
- Fuels containing more than 85% ethanol or E100 fuel.
- Fuels containing metallic-based additives, including manganese-based compounds.
- Fuels containing the octane booster additive, methylcyclopentadienyl manganese tricarbonyl (MMT).
- Leaded fuel (using leaded fuel is prohibited by law).

Note: Flex fuel vehicles can be fueled with gasoline, ethanol or a mixture of both.

Following a refuel, if the ethanol content of the fuel is different than what you used previously, we recommend that you drive your vehicle immediately for a minimum of 8 km (5 mi) to adapt to the change in ethanol concentration.

- Short stops do not affect the process.
- Do not switch the ignition off.
- Always observe speed limits and road conditions.

The engine control module needs to adapt to the fuel in the tank, especially when refueling more than half a tank.

If you do not follow this procedure, you may experience a minor degradation in engine starting performance and slight fluctuations in engine speed at idle. Until you complete the fuel learning process, these symptoms may continue.

Long-Term Storage

Most gasoline contains ethanol. We recommend that you fill the fuel tank with fuel that contains low ethanol (E10) if you intend to store your vehicle for more than two months. Alternatively, we recommend that you seek advice from an authorized dealer.

FUEL QUALITY - GASOLINE



WARNING: Do not mix diesel with gasoline, gasohol or alcohol. This could cause an explosion.



WARNING: Do not use leaded gasoline or gasoline with additives containing other metallic compounds, for example manganese-based. They could damage the emission system.

Fuel and Refueling

Use minimum 95 octane unleaded gasoline that meets the specification defined by EN 228 or the equivalent national specification.



E268502

Your vehicle is suitable for use with ethanol blends up to 10% (E5 and E10).

Note: We recommend that you only use high quality fuel. We do not recommend the use of aftermarket fuel additives or other engine treatments.

Long-Term Storage

Most gasoline contains ethanol. We recommend that you fill the fuel tank with fuel that does not contain ethanol if you intend to store your vehicle for more than two months.

FUEL QUALITY - DIESEL

 **WARNING:** Do not mix diesel with gasoline, gasohol or alcohol. This could cause an explosion.

Use diesel that meets the specification defined by EN 590 or the relevant national specification.



E268503

Your vehicle is suitable for use with biodiesel blends up to 7% (B7).

Note: We recommend that you only use high quality fuel. We do not recommend the use of aftermarket fuel additives or other engine treatments.

Note: We do not recommend the use of additional additives to prevent fuel waxing.

Long-Term Storage

Most diesel fuels contain biodiesel. We recommend that you fill the fuel tank with fuel that does not contain biodiesel if you intend to store your vehicle for more than two months.

FUEL FILLER FUNNEL LOCATION

The fuel filler funnel is in the spare wheel storage tray.

RUNNING OUT OF FUEL

Running out of fuel can cause damage not covered by the vehicle Warranty.

If your vehicle runs out of fuel:

- Add a minimum of 5 L (1.1 gal) of fuel to restart the engine.
- You may need to switch the ignition from off to on several times after refueling to allow the fuel system to pump the fuel from the tank to the engine. When restarting, cranking time takes a few seconds longer than normal.

Note: If your vehicle is on a steep slope, more fuel may be required.

Fuel and Refueling

Filling a Portable Fuel Container

 **WARNING:** Flow of fuel through a fuel pump nozzle can produce static electricity. This can cause a fire if you are filling an ungrounded fuel container.

Use the following guidelines to avoid electrostatic charge build-up, which can produce a spark, when filling an ungrounded fuel container:

- Only use an approved fuel container to transfer fuel to your vehicle. Place the container on the ground when filling it.
- Do not fill a fuel container when it is inside your vehicle (including the cargo area).
- Keep the fuel pump nozzle in contact with the fuel container when filling it.
- Do not use a device that holds the fuel pump nozzle lever in the fill position.

Adding Fuel From a Portable Fuel Container

 **WARNING:** Do not insert the nozzle of a fuel container or an aftermarket funnel into the fuel filler neck. This may damage the fuel system filler neck or its seal and cause fuel to run onto the ground.

 **WARNING:** Do not try to pry open or push open the capless fuel system with foreign objects. This could damage the fuel system and its seal and cause injury to you or others.

 **WARNING:** Do not dispose of fuel in the household refuse or the public sewage system. Use an authorized waste disposal facility.

When refueling the vehicle fuel tank from a fuel container, use the fuel filler funnel included with your vehicle. See **Fuel Filler Funnel Location** (page 185).

Note: Do not use aftermarket funnels as they may not work with the capless fuel system and can damage it.

When refueling the vehicle fuel tank from a fuel container, do the following:

1. Fully open the fuel filler door.
2. Fully insert the fuel filler funnel into the fuel filler inlet.



3. Add fuel to your vehicle from the fuel container.
4. Remove the fuel filler funnel.
5. Fully close the fuel filler door.
6. Clean the fuel filler funnel and place it back in your vehicle or correctly dispose of it.

Note: Extra funnels can be purchased from an authorized dealer if you choose to dispose of the funnel.

Fuel and Refueling

REFUELING

Refueling System Overview

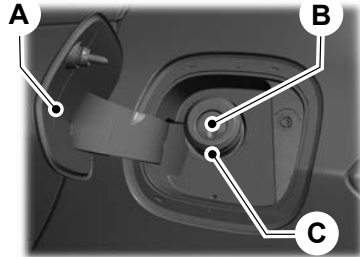

- A Fuel filler door.
- B Fuel tank filler valve.
- C Fuel tank filler pipe.

Your vehicle does not have a fuel tank filler cap.

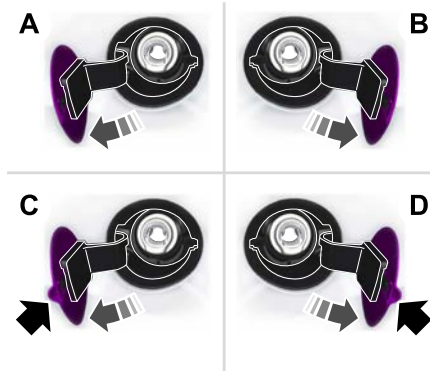

- A Left-hand side. To open the fuel filler door, press the center rear edge of the fuel filler door and then release.
- B Right-hand side. To open the fuel filler door, press the center rear edge of the fuel filler door and then release.
- C Left-hand side. Pull the rear of the fuel filler door to open it.
- D Right-hand side. Pull the rear of the fuel filler door to open it.

Refueling Your Vehicle

⚠ WARNING: When refueling always shut the engine off and never allow sparks or open flames near the fuel tank filler valve. Never smoke or use a cell phone while refueling. Fuel vapor is extremely hazardous under certain conditions. Avoid inhaling excess fumes.

⚠ WARNING: The fuel system may be under pressure. If you hear a hissing sound near the fuel filler inlet, do not refuel until the sound stops. Otherwise, fuel may spray out, which could cause serious personal injury.

⚠ WARNING: Do not pry open the fuel tank filler valve. This could damage the fuel system. Failure to follow this instruction could result in fire, personal injury or death.

⚠ WARNING: Do not remove the fuel pump nozzle from its fully inserted position when refueling.

Fuel and Refueling

WARNING: Stop refueling when the fuel pump nozzle automatically shuts off for the first time. Failure to follow this will fill the expansion space in the fuel tank and could lead to fuel overflowing.

WARNING: Do not overfill the fuel tank. The pressure in an overfilled tank may cause leakage and lead to fuel spray and fire.

WARNING: Wait at least five seconds before removing the fuel pump nozzle to allow any residual fuel to drain into the fuel tank.

1. Fully open the fuel filler door.
2. Select the correct fuel pump nozzle for your vehicle.

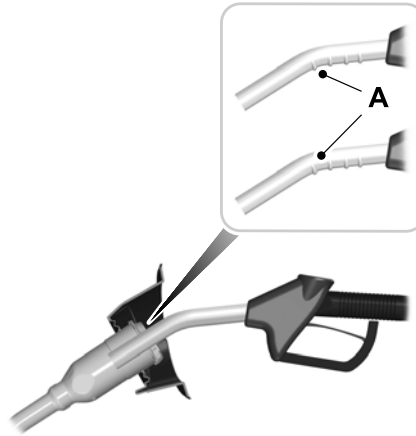

3. Insert the fuel pump nozzle up to the first notch on the nozzle A. Keep the fuel pump nozzle resting on the fuel tank filler pipe.

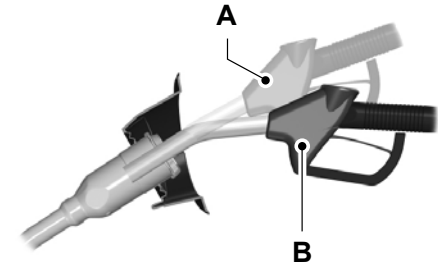

E139203

4. Hold the fuel pump nozzle in position B when refueling. Holding the fuel pump nozzle in position A can affect the flow of fuel and shut off the fuel pump nozzle before the fuel tank is full.

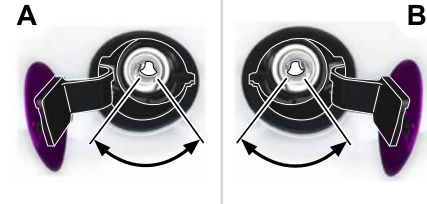

5. Operate the fuel pump nozzle within the area shown.

Fuel and Refueling

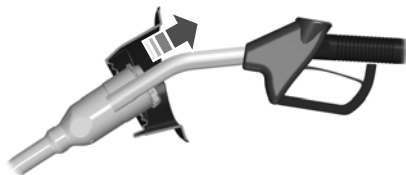

6. When you finish refueling slightly raise the fuel pump nozzle and slowly remove it.
7. Fully close the fuel filler door.

Do not attempt to start the engine if you have filled the fuel tank with incorrect fuel. Incorrect fuel use could cause damage not covered by the vehicle Warranty. Have your vehicle immediately checked.

Refueling System Warning (If Equipped)

If the fuel tank filler valve does not fully close, a message could appear in the information display.

Message
Check fuel fill inlet

If the message appears, do the following:

1. Stop your vehicle as soon as it is safe to do so and switch the engine off.
2. Shift into park (P) or neutral (N).
3. Apply the parking brake.
4. Fully open the fuel filler door.
5. Check the fuel tank filler valve for any debris that may be restricting its movement.
6. Remove any debris from the fuel tank filler valve.
7. Fully insert a fuel pump nozzle or the fuel filler funnel provided with your vehicle into the fuel filler pipe. See **Fuel Filler Funnel Location** (page 185). This action should dislodge any debris that may be preventing the fuel tank filler valve from fully closing.
8. Remove the fuel pump nozzle or fuel filler funnel from the fuel filler pipe.
9. Fully close the fuel filler door.

Note: *The message may not immediately reset. If the message continues to appear and a warning lamp illuminates, have your vehicle checked as soon as possible.*

FUEL CONSUMPTION

We derive CO₂ and fuel consumption figures in laboratory tests according to Regulation (EC) 715/2007 or CR (EC) 692/2008 and subsequent amendments.

They are intended as a comparison between makes and models of vehicles. They are not intended to represent the real world fuel consumption you may get from your vehicle.

Real world fuel consumption is governed by many factors, for example driving style, high speed driving, stop-start driving, air conditioning usage, add-on accessories, payload and towing.

Advertised Capacity

The advertised capacity is the maximum amount of fuel that you can add to the fuel tank when the fuel gauge indicates empty. See **Capacities and Specifications** (page 378).

In addition, the fuel tank contains an empty reserve. The empty reserve is an unspecified amount of fuel that remains in the fuel tank when the fuel gauge indicates empty.

Note: *The amount of fuel in the empty reserve varies and should not be relied upon to increase driving range.*

Fuel and Refueling

Fuel Economy

Your vehicle calculates fuel economy figures through the trip computer average fuel function. See **Trip Computer** (page 117).

The first 1,500 km (1,000 mi) of driving is the break-in period of the engine. A more accurate measurement is obtained after 3,000 km (2,000 mi).

Impacting Fuel Economy

- Incorrect tire inflation pressures. See **Tire Pressures** (page 353).
- Fully loading your vehicle.
- Carrying unnecessary weight.
- Adding certain accessories to your vehicle such as bug deflectors, rollbars or light bars, running boards and ski racks.
- Using fuel blended with alcohol. See **Fuel Quality** (page 185).
- Fuel economy may decrease with lower temperatures.
- Fuel economy may decrease when driving short distances.
- You may get better fuel economy when driving on flat terrain than when driving on hilly terrain.

Engine Emission Control

CATALYTIC CONVERTER

 **WARNING:** Do not park, idle or drive your vehicle on dry grass or other dry ground cover. The emission system heats up the engine compartment and exhaust system, creating the risk of fire.

 **WARNING:** The normal operating temperature of the exhaust system is very high. Never work around or attempt to repair any part of the exhaust system until it has cooled. Use special care when working around the catalytic converter. The catalytic converter heats up to a very high temperature after only a short period of engine operation and stays hot after the engine is switched off.

 **WARNING:** Exhaust leaks may result in entry of harmful and potentially lethal fumes into the passenger compartment. If you smell exhaust fumes inside your vehicle, have your vehicle inspected immediately. Do not drive if you smell exhaust fumes.

Your vehicle has various emission control components and a catalytic converter that enables it to comply with applicable exhaust emission standards.

To avoid damaging the catalytic converter:

- Do not crank the engine for more than 10 seconds at a time.
- Do not run the engine with a spark plug lead disconnected.
- Do not push-start or tow-start your vehicle. Use booster cables. See **Jump Starting the Vehicle** (page 286).
- Do not switch the ignition off when your vehicle is moving.
- Do not use leaded fuel.
- Avoid running out of fuel.

Note: *Resulting component damage may not be covered by the vehicle Warranty.*

On-Board Diagnostics System

Your vehicle has an on-board diagnostics system that monitors the emission control system. If any of the following warning lamps illuminate, this may indicate that the on-board diagnostics system has detected an emission control system malfunction.



Continuing to drive your vehicle may cause reduced power or the engine to stop. Failure to respond to a warning lamp may cause component damage not covered by the vehicle Warranty. Have your vehicle checked as soon as possible.

See **Warning Lamps and Indicators** (page 111).

Engine Emission Control

GASOLINE PARTICULATE FILTER



WARNING: Do not park or idle your vehicle over dry leaves, dry grass or other combustible materials. The regeneration process creates very high exhaust gas temperatures and the exhaust will radiate a considerable amount of heat during and after regeneration and after you have switched the engine off. This is a potential fire hazard.

To reduce the risk of causing damage to the gasoline particulate filter:

- Do not crank the engine for more than 10 seconds at a time.
- Do not push-start or tow-start your vehicle. Use booster cables.
- Do not switch the ignition off when your vehicle is moving.
- Do not ignore warning lamps, indicators or information messages.

Gasoline Particulate Filter Regeneration

Particles in the exhaust gas collect in the gasoline particulate filter causing a gradual restriction over time. This restriction is removed through a regeneration process controlled by the engine control system. The regeneration process converts the particles in the exhaust gas into harmless gases.

Regeneration occurs during normal driving, to varying degrees depending on how you drive. Passive regeneration occurs when you drive at moderate to high speed but if you generally drive short distances at low speed, the engine control system could actively raise the exhaust gas temperature to remove the particles that have collected in the filter to make sure that it continues to correctly operate.

To assist passive regeneration, we recommend that you make occasional journeys that allow you to:

- Drive at a varied range of conditions, including highway conditions for a minimum of 20 minutes.
- Avoid prolonged engine idling.
- Select a suitable gear to maintain engine speed between 1500 and 4000 RPM.

If the filter is saturated or is approaching saturation, a warning lamp illuminates or a message appears in the information display.

Note: *A warning lamp illuminates and a message appears in the information display on some vehicles.*

If you do not take action when a warning lamp illuminates or a message appears in the information display, you could cause damage not covered by the vehicle Warranty.

Gasoline Particulate Filter Warning Lamps and Indicators



Malfunction indicator lamp.

Engine Emission Control

Gasoline Particulate Filter Information Messages

Message	Action
Exhaust filter at limit Drive to clean now	<ul style="list-style-type: none">• Drive at a varied range of conditions, including highway conditions for 20 minutes or until the message disappears.• Avoid prolonged engine idling.• Select a suitable gear to maintain engine speed between 1500 and 4000 RPM.
Exhaust filter over limit Service now	<ul style="list-style-type: none">• Drive at a moderate speed.• Avoid heavy acceleration and deceleration.• Have your vehicle checked as soon as possible.

DIESEL PARTICULATE FILTER



WARNING: Do not park or idle your vehicle over dry leaves, dry grass or other combustible materials. The regeneration process creates very high exhaust gas temperatures and the exhaust will radiate a considerable amount of heat during and after regeneration and after you have switched the engine off. This is a potential fire hazard.



WARNING: The normal operating temperature of the exhaust system is very high. Never work around or attempt to repair any part of the exhaust system until it has cooled. Use special care when working around the diesel oxidation catalytic converter or the diesel particulate filter. The diesel oxidation catalytic converter and the diesel particulate filter heat up to very high temperatures after only a short period of engine operation and remain hot after you switch the engine off.



WARNING: Exhaust leaks may result in entry of harmful and potentially lethal fumes into the passenger compartment. If you smell exhaust fumes inside your vehicle, have your vehicle inspected immediately. Do not drive if you smell exhaust fumes.

Your vehicle has various emission control components and a diesel particulate filter that enables it to comply with applicable exhaust emission standards. It filters harmful diesel particulates, for example soot from the exhaust gas.

Engine Emission Control

To avoid damaging the diesel particulate filter:

- Do not crank the engine for more than 10 seconds at a time.
- Do not push-start or tow-start your vehicle. Use booster cables. See **Jump Starting the Vehicle** (page 286).
- Do not switch the ignition off when your vehicle is moving.
- Do not ignore warning lamps or information messages regarding exhaust system cleaning and regeneration.

Note: *This could result in damage not covered by the vehicle Warranty.*

On-Board Diagnostics System

Your vehicle has an on-board diagnostics system that monitors the emission control system. If any of the following warning lamps illuminate, this indicates that the on-board diagnostics system has detected an emission control system malfunction.



Engine coolant temperature warning lamp.



Ignition warning lamp.



Malfunction indicator lamp.



Powertrain warning Lamp.



Water in fuel warning lamp.

If you continue to drive your vehicle with a warning lamp illuminated, the engine could stop without warning. This could result in damage not covered by the vehicle warranty. Have your vehicle checked as soon as possible.

See **Warning Lamps and Indicators** (page 111).

Diesel Particulate Filter Automatic Regeneration



WARNING: Do not park or idle your vehicle over dry leaves, dry grass or other combustible materials. The regeneration process creates very high exhaust gas temperatures and the exhaust will radiate a considerable amount of heat during and after regeneration and after you have switched the engine off. This is a potential fire hazard.



WARNING: The normal operating temperature of the exhaust system is very high. Never work around or attempt to repair any part of the exhaust system until it has cooled. Use special care when working around the diesel oxidation catalytic converter or the diesel particulate filter. The diesel oxidation catalytic converter and the diesel particulate filter heat up to very high temperatures after only a short period of engine operation and remain hot after you switch the engine off.

Engine Emission Control

The diesel particulate filter on your vehicle requires periodic regeneration to maintain correct operation. The emission control system automatically carries out this process. As soot gathers in the system it begins to restrict the filter. The soot that gathers inside the filter is cleaned in two different ways, passive regeneration and active regeneration. Both methods occur automatically and require no actions from the driver. During automatic regeneration, the system cleans the diesel particulate filter by oxidizing the soot. Cleaning happens during normal engine operating conditions at varying levels depending on driving conditions.



Diesel particulate filter warning lamp.

If the diesel particulate filter is near or at saturation, a warning lamp or information message appears in the information display. Drive your vehicle in a manner to allow effective diesel particulate filter cleaning.

The warning lamp continues to illuminate until the automatic regeneration process completes. Continue to drive your vehicle in a manner to allow effective diesel particulate filter cleaning until the warning lamp turns off.

Failure to carry out regeneration when required could result in a clogged diesel particulate filter. If the diesel particulate filter fills beyond the regeneration threshold, the system disables the ability to carry out regeneration. This could result in damage not covered by the vehicle warranty.

Where vehicle use meets any of the following conditions:

- Driving short distances.
- Prolonged engine idling.
- Frequently switching the engine on and off.
- High levels of acceleration and deceleration.

We recommend you assist the regeneration process by:

- Avoiding prolonged engine idling.
- Drive your vehicle in a manner to allow effective cleaning. Drive at a steady vehicle speed of 48 km/h (30 mph) or above for approximately 20 minutes.



If the soot load in the diesel particulate filter reaches a critical level, the malfunction indicator lamp illuminates with the diesel particulate filter warning message. A service regeneration must be performed to recover the particulate filter. Have your vehicle checked as soon as possible to prevent further damage.

Automatic regeneration raises the exhaust temperature to eliminate the soot particles. During cleaning, soot particles are converted to harmless gasses. Once cleaned, the diesel particulate filter continues to trap harmful diesel particles.

If you are driving your vehicle in a manner that allows effective cleaning, a message may appear in the information display to indicate automatic regeneration is in progress.

If you are not driving your vehicle in a manner that allows effective cleaning, a message may appear in the information display to instruct you to drive in a manner that allows automatic regeneration.

Engine Emission Control

The automatic regeneration process is most effective when you drive at a steady vehicle speed of 48 km/h (30 mph) or above for approximately 20 minutes. The frequency and duration of the regeneration process varies by how you drive your vehicle, the outside air temperature and altitude.

Frequency varies between 160 km (100 mi) and 500 km (310 mi) and each regeneration process lasts between 10 and 20 minutes.

Note: *Changes in the engine or exhaust sound may be heard during the regeneration process.*

Note: *During regeneration at low speed or engine idle, you could smell a hot metallic odor and could notice a clicking metallic sound. This is due to the high temperatures reached during the regeneration process. This is normal.*

Manual Transmission

MANUAL TRANSMISSION PRECAUTIONS

Do not rest your hand on the gearshift lever or use the gearshift lever to hang and support objects. This could cause damage to the transmission not covered by the vehicle Warranty.

Do not rest your foot on the clutch pedal or use the clutch pedal to keep your vehicle stationary when waiting on a hill. This could cause damage to the clutch not covered by the vehicle Warranty.

Failure to fully press the clutch pedal could cause increased shift efforts, premature wear transmission components or damage to the transmission.

SHIFTING INTO REVERSE - 5-SPEED MANUAL TRANSMISSION

Do not shift into reverse when your vehicle is moving. This could cause damage to the transmission not covered by the vehicle Warranty.

1. Fully press the brake pedal.

2. Fully press the clutch pedal and shift into neutral before shifting into reverse.

SHIFTING INTO REVERSE - 6-SPEED MANUAL TRANSMISSION

Do not shift into reverse when your vehicle is moving. This could cause damage to the transmission not covered by the vehicle Warranty.

1. Fully press the brake pedal.
2. Fully press the clutch pedal and shift into neutral.

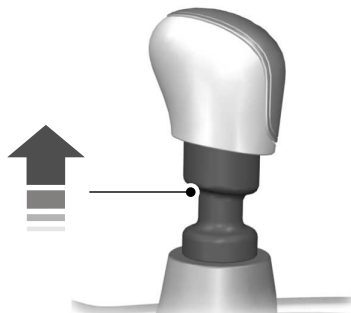

3. Raise the collar and shift into reverse.

MANUAL TRANSMISSION SHIFT INDICATORS



It illuminates to advise you that shifting gear may give better fuel economy or lower emissions.



CHECKING THE CLUTCH FLUID LEVEL

The clutch and brake systems share the same fluid reservoir. See **Brake Fluid Check** (page 321).

CLUTCH FLUID SPECIFICATION

Only use fluid that meets Ford specifications.

Manual Transmission

Materials

Name	Specification
Brake Fluid DOT 4 LV High Performance BU7J-M6C65-xxxx	WSS-M6C65-A2

MANUAL TRANSMISSION – TROUBLESHOOTING

Manual Transmission – Frequently Asked Questions

What should I do if any gear is not fully engaged?

Fully press the clutch pedal and shift into neutral. Release the clutch pedal for a moment, fully press the clutch pedal again and shift into gear.

Automatic Transmission

AUTOMATIC TRANSMISSION PRECAUTIONS



WARNING: Do not apply the brake pedal and accelerator pedal simultaneously. Applying both pedals simultaneously for more than a few seconds will limit engine performance, which may result in difficulty maintaining speed in traffic and could lead to serious injury.



WARNING: When your vehicle is stationary, keep the brake pedal fully pressed when shifting gears. Failure to follow this instruction could result in personal injury, death or property damage.



WARNING: Apply the parking brake, shift into park (P), switch the ignition off and remove the key before you leave your vehicle. Failure to follow this instruction could result in personal injury or death.

AUTOMATIC TRANSMISSION POSITIONS

Park (P)

In park (P), power is not transmitted to the driven wheels and the transmission is locked. You can start the engine with the transmission in this position.

Shift into park (P) only when your vehicle is stationary.

Reverse (R)

Shift into reverse (R) only when your vehicle is stationary and the engine is at idle speed.

Neutral (N)

In neutral (N), power is not transmitted to the driven wheels but the transmission is not locked. In neutral (N) your vehicle has the ability to roll freely. You can start the engine with the transmission in this position.

Drive (D)

Drive (D) is the normal position for driving.

Low (L) - 7-Speed Automatic Transmission, Vehicles Without: Paddle Shifters

Low (L) provides maximum engine braking.

Note: *In order to activate low (L) your vehicle must be in drive (D).*

Note: *You can shift into low (L) at any vehicle speed.*

Manual (M) - 7-Speed Automatic Transmission, Vehicles With: Paddle Shifters

Manual (M) provides permanent manual control of the gear selection.

Note: *In order to activate manual (M) your vehicle must be in drive (D).*

Note: *You can shift into manual (M) at any vehicle speed.*

Automatic Transmission

AUTOMATIC TRANSMISSION POSITION INDICATORS - 7-SPEED AUTOMATIC TRANSMISSION, VEHICLES WITHOUT: PADDLE SHIFTERS

P R N D L

The instrument cluster displays the current position.

AUTOMATIC TRANSMISSION POSITION INDICATORS - 7-SPEED AUTOMATIC TRANSMISSION, VEHICLES WITH: PADDLE SHIFTERS

P R N D M

The instrument cluster displays the current position.

AUTOMATIC TRANSMISSION SHIFT INDICATORS - VEHICLES WITH: PADDLE SHIFTERS

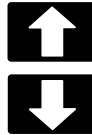

Shift indicators illuminate to advise you that shifting gear may give better fuel economy or lower emissions.

MANUALLY SHIFTING GEARS

Shifting Using the Paddle Shifters

You can only manually shift gears in drive (D) or manual (M).

Manually Shifting Gears in Drive (D)



Pull any paddle to switch the feature on.

- Pull the right paddle (+) to upshift.
- Pull the left paddle (-) to downshift.

Note: The feature turns off if neither paddle is pulled within a short period of time.

Note: Hold the right paddle for a few seconds to turn off the feature manually.

Manually Shifting Gears in Manual (M)



- Pull the right paddle (+) to upshift.
- Pull the left paddle (-) to downshift.

Shift into drive (D) to switch the feature off.

Automatic Transmission

BRAKE SHIFT INTERLOCK

What Is Brake Shift Interlock

Brake shift interlock prevents you from shifting out of park (P) when you have switched the ignition on and not pressed the brake pedal.

Brake Shift Interlock Precautions

⚠ WARNING: Do not drive your vehicle until you verify that the stoplamps are working.

⚠ WARNING: When doing this procedure, you need to take the transmission out of park (P) which means your vehicle can roll freely. To avoid unwanted vehicle movement, always fully apply the parking brake prior to doing this procedure. Use wheels chocks if appropriate.

⚠ WARNING: If the parking brake is fully released, but the brake warning lamp remains illuminated, the brakes may not be working properly. Have your vehicle checked as soon as possible.

In the event of an electrical malfunction, it is possible that a fuse has blown or the stoplamps are not working.

If the vehicle battery has no charge, jump start your vehicle. See **Jump Starting the Vehicle** (page 286).

Using Brake Shift Interlock

Use the brake shift interlock lever to move the selector lever out of park (P) if you cannot start the engine.

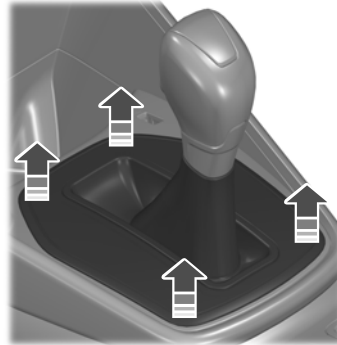

E269819

1. Remove the panel.

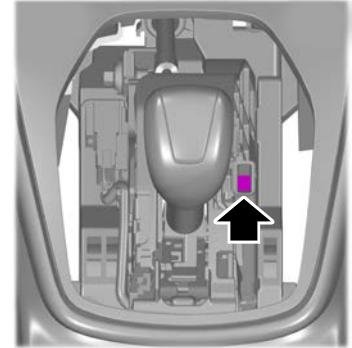

2. Locate the access hole.
3. Using a flat-bladed screwdriver, push the brake shift interlock lever toward the front of your vehicle and hold it there.
4. Move the selector lever from park (P) to neutral (N).
5. Install the panel.
6. Press the brake pedal, start the engine and release the parking brake.

Automatic Transmission

AUTOMATIC TRANSMISSION AUDIBLE WARNINGS

Sounds when you open the driver door and you have not moved the transmission selector to park (P).

Transmission Not in Park (P) Audible Warning

AUTOMATIC TRANSMISSION – TROUBLESHOOTING

Automatic Transmission – Information Messages

Message	Description
Transmission malfunction Service now	The system has detected a fault that requires service. Have your vehicle checked as soon as possible.
Transmission limited function See manual	The transmission has limited functionality. The system has detected a fault that requires service. Have your vehicle checked as soon as possible.
Transmission too hot Press brake Transmission overheating Stop safely	The transmission is overheating and needs to cool. Stop your vehicle as soon as it is safe to do so, leave the engine running and allow the transmission to cool. Wait until the message disappears.
Transmission not in Park	Displays as a reminder to shift into park (P).

Brakes

GENERAL INFORMATION

Note: Occasional brake noise is normal. If a metal-to-metal, continuous grinding or continuous squeal sound is present, the brake linings may be worn-out. If your vehicle has continuous vibration or shudder in the steering wheel while braking, have your vehicle checked by an authorized dealer.

Note: Brake dust may accumulate on the wheels, even under normal driving conditions. Some dust is inevitable as the brakes wear. See **Cleaning Wheels** (page 334).

Note: Depending on applicable laws and regulations in the country for which your vehicle was originally built, the brake lamps may flash during heavy braking. Following this the hazard warning flashers may also flash when your vehicle comes to a stop.

Wet brakes result in reduced braking efficiency. Gently press the brake pedal a few times when driving from a car wash or standing water to dry the brakes.

Brake Over Accelerator

In the event the accelerator pedal becomes stuck or entrapped, apply steady and firm pressure to the brake pedal to slow the vehicle and reduce engine power. If you experience this condition, apply the brakes and bring your vehicle to a safe stop. Shift the transmission to park (P) (automatic transmission) or to a low gear (manual transmission), switch the engine off and apply the parking brake. Inspect the accelerator pedal and the area around it for any items or debris that may be obstructing its movement. If none are found and the condition persists, have your vehicle towed to the dealer for service.

Brake Assist

Brake assist detects when you brake heavily by measuring the rate at which you press the brake pedal. It provides maximum braking efficiency as long as you press the pedal. Brake assist can reduce stopping distances in critical situations.

Anti-lock Brake System

This system helps you maintain steering control and vehicle stability during emergency stops by keeping the brakes from locking.

HINTS ON DRIVING WITH ANTI-LOCK BRAKES

The anti-lock braking system does not eliminate the risks when:

- You drive too closely to the vehicle in front of you.
- Your vehicle is hydroplaning.
- You take corners too fast.
- The road surface is poor.

Note: If the system activates, the brake pedal may pulse and may travel further. Maintain pressure on the brake pedal. You may also hear a noise from the system. This is normal.

PARKING BRAKE - MANUAL TRANSMISSION



WARNING: Always set the parking brake fully.

Note: If you park your vehicle on a hill and facing uphill select first gear and turn the steering wheel away from the curb.

Brakes

Note: If you park your vehicle on a hill and facing downhill select reverse gear and turn the steering wheel toward the curb.

Note: Do not press the release button while pulling the lever up.

To apply the parking brake:

1. Press the foot brake pedal firmly.
2. Pull the parking brake lever up to its fullest extent.

To release the parking brake:

1. Press the brake pedal firmly.
2. Pull the lever up slightly.
3. Press the release button and push the lever down.

PARKING BRAKE - AUTOMATIC TRANSMISSION



WARNING: Always fully apply the parking brake and make sure you shift into park (P). Switch the ignition off and remove the key whenever you leave your vehicle.

To apply the parking brake:

1. Firmly press the brake pedal.

2. Pull the parking brake lever upward to its fullest extent.

Note: Do not press the release button when pulling the parking brake lever upward.

Note: If you park your vehicle on a hill and facing uphill, shift into park (P) and turn the steering wheel away from the curb.

Note: If you park your vehicle on a hill and facing downhill, shift into park (P) and turn the steering wheel toward the curb.

To release the parking brake:

1. Firmly press the brake pedal.
2. Slightly pull the parking brake lever upward.
3. Press the release button and push the parking brake lever downward.

HILL START ASSIST



WARNING: The system does not replace the parking brake. When you leave your vehicle, always apply the parking brake and shift the transmission into park (P) for automatic transmission or first gear for manual transmission.



WARNING: You must remain in your vehicle when the system turns on. At all times, you are responsible for controlling your vehicle, supervising the system and intervening, if required. Failure to take care may result in the loss of control of your vehicle, serious personal injury or death.



WARNING: The system turns off if there is a malfunction or if you excessively rev the engine.

The system makes it easier to pull away when your vehicle is on a slope without the need to use the parking brake.

When the system activates, your vehicle remains stationary on a slope for a few seconds after you release the brake pedal. This allows you time to move your foot from the brake to the accelerator pedal. The brakes release when the engine has developed sufficient torque to prevent your vehicle from rolling down the slope. This is an advantage when pulling away on a slope, for example from a car park ramp, traffic lights or when reversing uphill into a parking space.

The system activates on any slope that causes your vehicle to roll.

Brakes

Note: *There is no warning lamp to indicate the system is either on or off.*

Using Hill Start Assist

1. Press the brake pedal to bring your vehicle to a complete standstill. Keep the brake pedal pressed and shift into first gear when facing uphill or reverse (R) when facing downhill.
2. The system activates if the sensors detect that your vehicle is on a slope.
3. When you remove your foot from the brake pedal, your vehicle remains on the slope without rolling away for a few seconds. This hold time increases if you are in the process of driving off.
4. Pull away in the normal manner.

Switching the System On and Off

Vehicles with Manual Transmission

You can switch this feature on or off in the information display. The system remembers the last setting when you start your vehicle.

Vehicles with Automatic Transmission

The system turns on when you switch the ignition on and you cannot switch the system off.

Traction Control

PRINCIPLE OF OPERATION

The traction control system helps avoid drive wheel spin and loss of traction.

If your vehicle begins to slide, the system applies the brakes to individual wheels and, when needed, reduces engine power at the same time. If the wheels spin when accelerating on slippery or loose surfaces, the system reduces engine power in order to increase traction.

USING TRACTION CONTROL



WARNING: The stability and traction control light illuminates steadily if the system detects a failure. Make sure you did not manually disable the traction control system using the information display controls or the switch. If the stability control and traction control light is still illuminating steadily, have the system serviced by an authorized dealer immediately. Operating your vehicle with the traction control disabled could lead to an increased risk of loss of vehicle control, vehicle rollover, personal injury and death.

If your vehicle is stuck in mud or snow, switching traction control off may be beneficial as this allows the wheels to spin.

Switching the System On and Off



Press the button on the center console.

Note: When you switch the traction control off, stability control remains on.

Note: The system turns on when you switch the ignition on.

Note: When you switch the system on or off, a warning lamp illuminates in the instrument cluster. It also illuminates if the system activates or if the system detects a malfunction. See **Warning Lamps and Indicators** (page 111).

Stability Control

PRINCIPLE OF OPERATION

Electronic Stability Control

 **WARNING:** The system is designed to aid the driver. It is not intended to replace your attention and judgment. You are still responsible to drive with due care and attention.

The system supports stability when your vehicle starts to slide away from your intended path. The system does this by braking individual wheels and reducing engine torque.

The system also provides an enhanced traction control function by reducing engine torque if the wheels spin when you accelerate. This helps to pull away on slippery roads or loose surfaces, and improves comfort by limiting wheel spin in hairpin bends.

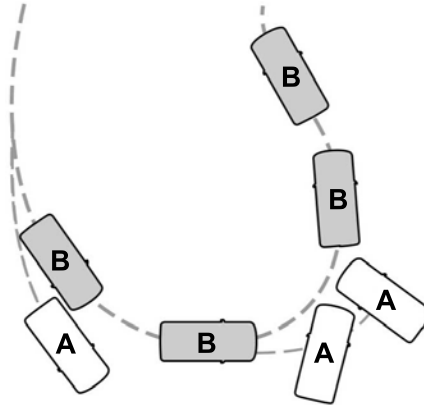

- A Without ESC.
- B With ESC.

Stability Control Warning Lamp



Flashes during operation. See **Warning Lamps and Indicators** (page 111).

USING STABILITY CONTROL

Note: The system automatically turns on each time you switch the ignition on.

You can switch the traction control system off and on. See **Using Traction Control** (page 206).

Parking Aids

PRINCIPLE OF OPERATION

 **WARNING:** The system may not detect objects with surfaces that absorb reflection. Always drive with due care and attention. Failure to take care may result in a crash.

 **WARNING:** To help avoid personal injury, always use caution when in reverse (R) and when using the sensing system.

 **WARNING:** Traffic control systems, inclement weather, air brakes, external motors and fans may affect the correct operation of the sensing system. This may cause reduced performance or false alerts.

 **WARNING:** The system may not detect small or moving objects, particularly those close to the ground.

Note: *Some accessories such as large trailer hitches, bike or surfboard racks can cause reduced performance or false alerts.*

Note: *Keep the sensors free from snow, ice and large accumulations of dirt. Blocked sensors may affect system accuracy. Do not clean the sensors with sharp objects.*

Note: *If your vehicle sustains damage leaving the sensors misaligned, this will cause inaccurate measurements or false alerts.*

Note: *The sensing system cannot be turned off when a MyKey is present. See **What Is MyKey** (page 59).*

We recommend that you take some time to get to know the system and its limitations by reading this section.

The sensing system warns the driver of obstacles within a certain range of your vehicle. The system automatically turns on each time you switch the ignition on.





You can turn the system on or off by pressing the parking aid button. If your vehicle does not have a parking aid button, the system can be switched off through the information display menu or from the pop-up message that appears once you shift the transmission into reverse (R). See **General Information** (page 116).

If a fault is present in the system, a warning message appears in the information display and does not allow you to switch the system on.

See **Information Messages** (page 121).

REAR PARKING AID

 **WARNING:** The system may not detect objects with surfaces that absorb reflection. Always drive with due care and attention. Failure to take care may result in a crash.

 **WARNING:** The system may not detect small or moving objects, particularly those close to the ground.

 **WARNING:** To help avoid personal injury, always use caution when in reverse (R) and when using the sensing system.

 **WARNING:** The parking aid system can only assist you to detect objects when your vehicle is moving at parking speeds. To help avoid personal injury you must take care when using the parking aid system.

If the system malfunctions, a message appears in the information display.

Note: *Keep the sensors free from snow, ice and large accumulations of dirt.*

Note: *Do not cover up the sensors.*

Note: *Do not clean the sensors with sharp objects.*

Parking Aids

Note: *If your vehicle sustains damage leaving the sensors misaligned, this may cause inaccurate measurements or false alerts.*

Note: *Some add-on accessories, for example large trailer hitches or bike or surfboard racks can cause reduced performance or false alerts.*

The sensors are active when the transmission is in reverse (R) and the vehicle speed is less than 8 km/h (5 mph). When the parking aid system sounds a tone, the audio system may reduce the set volume.

A warning tone sounds when an object approaches your vehicle. As your vehicle moves closer to an object, the rate of the tone increases. The warning tone continuously sounds when an object is 30 cm (12 in) or less from the center of the rear bumper.

Note: *There is a decreased coverage area at the outer corners.*



Sensor coverage area is up to 180 cm (70 in) from the rear bumper.

The system detects large objects when you shift into reverse (R) and any of the following occur:

- Your vehicle is moving backward at low speed.
- Your vehicle is stationary but an object is approaching the rear of your vehicle at low speed.
- Your vehicle is moving backward at low speed and an object is moving toward your vehicle, for example another vehicle at low speed.

If your vehicle remains stationary for two seconds the audible warning turns off. If your vehicle moves backward the tone sounds again.

Note: *If the detected object is 30 cm (12 in) or less from the rear bumper, the audible warning does not turn off.*

Object Distance Indicator (If Equipped)

When you shift into reverse (R), the system provides object distance indication through the information display.

- As the distance to the object decreases, the indicator blocks illuminate and move toward the vehicle icon.
- If there is no object detected, the distance indicator blocks are gray.

Parking Aids

Rear Parking Aid Information Messages

Message	Description
Park Pilot malfunction	The system has malfunctioned. Have your vehicle checked as soon as possible.
Check Park Pilot	The system has malfunctioned. Have your vehicle checked as soon as possible.
Check rear Park Pilot	The system has malfunctioned. Have your vehicle checked as soon as possible.
Rear Park Pilot not available Sensor blocked See manual	A sensor is blocked or the system has malfunctioned. Clean the bumper or remove any obstruction. If the message continues to appear, have your vehicle checked as soon as possible.

FRONT PARKING AID



WARNING: The system may not detect objects with surfaces that absorb reflection. Always drive with due care and attention. Failure to take care may result in a crash.



WARNING: The system may not detect small or moving objects, particularly those close to the ground.



WARNING: The parking aid system can only assist you to detect objects when your vehicle is moving at parking speeds. To help avoid personal injury you must take care when using the parking aid system.

The sensors are on the front bumper.

Note: *Keep the sensors free from snow, ice and large accumulations of dirt.*

Note: *Do not cover up the sensors.*

Note: *Do not clean the sensors with sharp objects.*

Note: *If your vehicle sustains damage leaving the sensors misaligned, this may cause inaccurate measurements or false alerts.*

The sensors are active when the transmission is in any position other than park (P). When the parking aid system sounds a tone, the audio system may reduce the set volume.

A warning tone sounds when an object approaches your vehicle. As your vehicle moves closer to an object, the rate of the tone increases. The warning tone continuously sounds when an object is 30 cm (12 in) or less from the front bumper.

The system turns off when the vehicle speed reaches 8 km/h (5 mph).

Parking Aids



Sensor coverage area is up to 70 cm (28 in) from the center of the bumper.

If the transmission is in reverse (R), the system detects objects when your vehicle is moving at low speed or an object is moving toward your vehicle, for example another vehicle at low speed. When you stop your vehicle, the audible warning turns off after two seconds.

If the transmission is in any forward gear, the system provides audible warnings when your vehicle is moving and an object is within the detection area. When you stop your vehicle, the audible warning turns off after two seconds and the visual warning turns off after four seconds.



Press the parking aid button to switch the system off.

If the system malfunctions, a message appears in the information display.

Object Distance Indicator (If Equipped)

The system provides object distance indication through the information display.

- As the distance to the object decreases, the indicator blocks illuminate and move toward the vehicle icon.
- If there is no object detected, the distance indicator blocks are gray.

When you shift into reverse (R), the system provides audio warnings and visual indication when your vehicle is moving and the detected object is moving toward your vehicle. When you stop your vehicle, the audio warnings stop after two seconds. Visual indication remains on when the transmission is in reverse (R).

When you shift into any forward gear, the system provides audio warnings and visual indication when your vehicle is moving at a speed of approximately 8 km/h (5 mph) or below and the system detects an object within the detection zone. When you stop your vehicle, the audio warnings stop after two seconds and visual indication stops after four seconds.

Note: If the detected object is 30 cm (12 in) or less from your vehicle, visual indication remains on.

When you shift into neutral (N), the system only provides visual indication if your vehicle is moving at a speed of approximately 8 km/h (5 mph) or below, for example, your vehicle is moving on a slope, and the system detects an object moving toward your vehicle. When you stop your vehicle, visual indication stops after four seconds.

Parking Aids

Front Parking Aid Information Messages

Message	Description
Park Pilot malfunction	The system has malfunctioned. Have your vehicle checked as soon as possible.
Check Park Pilot	The system has malfunctioned. Have your vehicle checked as soon as possible.
Check front Park Pilot	The system has malfunctioned. Have your vehicle checked as soon as possible.
Front Park Pilot not available sensor blocked See Manual	A sensor is blocked or the system has malfunctioned. Clean the bumper or remove any obstruction. If the message continues to appear, have your vehicle checked as soon as possible.

SIDE SENSING SYSTEM



WARNING: The system may not detect objects with surfaces that absorb reflection. Always drive with due care and attention. Failure to take care may result in a crash.



WARNING: The system may not detect small or moving objects, particularly those close to the ground.



WARNING: To help avoid personal injury, always use caution when in reverse (R) and when using the sensing system.



WARNING: The parking aid system can only assist you to detect objects when your vehicle is moving at parking speeds. To help avoid personal injury you must take care when using the parking aid system.

The system uses the front and rear outermost parking aid sensors to detect objects that are near to the sides of your vehicle. The system displays them on a virtual map in the information display as your vehicle moves past them.

The sensors are on the front and rear bumpers.

Note: Keep the sensors free from snow, ice and large accumulations of dirt.

Note: Do not cover up the sensors.

Note: Do not clean the sensors with sharp objects.

Note: If your vehicle sustains damage leaving the sensors misaligned, this may cause inaccurate measurements or false alerts.

The system may not function if:

- You switch the ignition on, off and back on within a few seconds.
- Your vehicle remains stationary for over two minutes.
- The anti-lock brake system activates.
- The traction control system activates.

Note: If you switch traction control off, the side sensing system also turns off.

Parking Aids

Note: Some accessories, for example large trailer hitches or bike or surfboard racks can cause reduced performance or false alerts.

To reinitialize the system, you may have to drive your vehicle approximately 3 m (10 ft).



The sensor coverage area is up to 60 cm (24 in) from the side of your vehicle.

When the system detects an object within the coverage area and the driving path of your vehicle, an audible warning sounds. As your vehicle moves closer to the object, the rate of the tone increases.

Note: The system does not detect an object that is moving toward the side of your vehicle, for example another vehicle moving at low speed, if it does not pass a front or rear sensor.

Object Distance Indicator (If Equipped)



The system provides object distance indication through the information display.

- As the distance to the object decreases, the indicator blocks illuminate and move toward the vehicle icon.
- If there is no object detected, the distance indicator blocks are gray.

When you shift into reverse (R), the system provides audible warnings and a visual indication when detected objects are within 60 cm (24 in) and are inside the driving path of your vehicle. When you stop your vehicle, the audible warnings turn off after two seconds.

When you shift into any forward gear, the system provides audible warnings and a visual indication when your vehicle is moving at a speed of approximately 8 km/h (5 mph) or below and the system detects an object within the detection zone. When you stop your vehicle, the audible warnings turn off after two seconds and the visual indication turns off after four seconds.

When you shift into neutral (N), the system only provides a visual indication if your vehicle is moving at a speed of approximately 8 km/h (5 mph) or below. For example, your vehicle is moving on a slope, and the system detects an object moving toward your vehicle. When you stop your vehicle, the visual indication turns off after four seconds.

Parking Aids

If the system is not available, the side distance indicator blocks do not display.

ACTIVE PARK ASSIST

The system assists parking into and out of parking spaces. Sensors are used to detect parking spaces. The system then steers as required to maneuver into or out of a parking space. You control the accelerator, brakes and changing gears.

Using Active Park Assist

 **WARNING:** You must remain in your vehicle when the system turns on. At all times, you are responsible for controlling your vehicle, supervising the system and intervening, if required. Failure to take care may result in the loss of control of your vehicle, serious personal injury or death.

 **WARNING:** The sensors may not detect objects in heavy rain or other conditions that cause interference.



WARNING: You are responsible for controlling your vehicle at all times. The system is designed to be an aid and does not relieve you of your responsibility to drive with due care and attention. Failure to follow this instruction could result in the loss of control of your vehicle, personal injury or death.



The active park assist button is next to the gearshift lever.

Driving into a Parking Space

1. Press the active park assist button.

Note: *The system searches for parallel parking spaces on the passenger side. Press the active park assist button again to make the system search for perpendicular spaces.*

2. Use the direction indicator lever to search for a parking space on the driver or passenger side of your vehicle.
3. Drive your vehicle approximately 1 m (3 ft) away from and parallel to the other parked vehicles when searching for a parking space.

Note: *A tone sounds and a message appears in the information display when active park assist finds a suitable parking space.*

4. Bring your vehicle to a complete standstill.
5. Release the steering wheel and shift into reverse (R).
6. Drive backward and your vehicle steers itself into the parking space.
7. Follow the instructions on the information display.

Note: *When parking is complete, a tone sounds and an information message appears.*

Leaving a Parking Space

The system assists leaving only parallel parking spaces.

1. Press the active park assist button.
2. Use the direction indicator lever to choose the direction to leave.
3. Release the steering wheel and shift into reverse (R).
4. Follow the instructions on the information display.

Parking Aids

Note: After the system drives your vehicle to a position where you can exit the parking space in a forward movement, a message appears instructing you to take full control of your vehicle.

Canceling Active Park Assist

To cancel parking assistance at any time, press the active park assist button or turn the steering wheel.

Note: It also cancels when your vehicle exceeds 9 km/h (6 mph).

Brake System Intervention

When active park assist is controlling the steering, it may under certain conditions apply the brakes to slow or stop your vehicle.

Note: This could cause the parking assistance to cancel.

Active Park Assist Troubleshooting

Symptom	Possible Cause
The system does not search for a parking space.	You may have switched traction control off.
	The transmission is in reverse (R). Your vehicle must be moving forward to be able to detect a parking space.
The system does not offer a parking space.	The sensors may be blocked. For example, snow, ice or large accumulations of dirt. Blocked sensors can affect how the system functions.
	The sensors in the front or rear bumper could be damaged.
	There is not enough room in the parking space for your vehicle to safely park.
	There is not enough space for the parking maneuver on the opposite side of the parking space.
	The parking space is more than 1.5 m (5 ft) or less than 0.5 m (2 ft) away.
	The vehicle speed is greater than 35 km/h (22 mph) for parallel parking or greater than 30 km/h (19 mph) for perpendicular parking.
	You recently disconnected or replaced the battery. After you reconnect the battery you must drive your vehicle on a straight road for a short period of time.

Parking Aids

Symptom	Possible Cause
The system does not correctly position your vehicle in a parking space.	An irregular curb along the parking space prevents the system from correctly aligning your vehicle.
	Vehicles or objects bordering the space may not be correctly parked.
	Your vehicle stopped too far past the parking space.
	The tires may not be correctly installed or maintained. For example, not inflated correctly, improper size, or of different sizes.
	A repair or alteration changes the detection capabilities.
	A parked vehicle has a high attachment. For example, a salt sprayer, snowplow or moving truck bed.
	The parking space length or position of parked objects changes after your vehicle passes the space.
	You are using a spare tire or a tire that is significantly worn more than the other tires.
	The temperature around your vehicle quickly changes. For example, driving from a heated garage into cold outside temperature, or after leaving a car wash.

Parking Aids

REAR VIEW CAMERA

 **WARNING:** The rear view camera system is a reverse aid supplement device that still requires the driver to use it in conjunction with the interior and exterior mirrors for maximum coverage.

 **WARNING:** Objects that are close to either corner of the bumper or under the bumper, might not be seen on the screen due to the limited coverage of the camera system.

 **WARNING:** Reverse your vehicle slowly. Failure to follow this instruction could result in the loss of control of your vehicle, personal injury or death.

 **WARNING:** Use caution when the liftgate is ajar. If the liftgate is ajar, the camera will be out of position and the video image may be incorrect. All guidelines disappear when the liftgate is ajar. Failure to follow this instruction could result in personal injury.

 **WARNING:** Do not switch the camera features on or off when your vehicle is moving.

 **WARNING:** The operation of the camera may vary depending on the ambient temperature, vehicle and road conditions.

 **WARNING:** To help avoid personal injury always use caution when in reverse (R) and when using the rear view camera.

The rear view camera provides an image of the area behind your vehicle. During operation, lines appear in the display that represents the path of your vehicle and proximity to objects behind it.



E249202

The camera is on the liftgate.

Using the Rear View Camera

The rear view camera system displays what is behind your vehicle when you shift the transmission into reverse (R).

Note: When towing, the camera only sees what you are towing. In some vehicles, the guidelines may disappear when you connect the trailer tow connector.

The system may not correctly operate in any of the following conditions:

- Nighttime or dark areas if the reverse lamps are not operating.
- If the camera is obstructed. Clean the lens with a soft, lint-free cloth and non-abrasive cleaner.
- The camera is misaligned due to damage to the rear of your vehicle.

Rear View Camera Guidelines

 **WARNING:** Objects above the camera may not be visible. Check the area behind your vehicle when necessary.

If the vehicle battery is disconnected, the guidelines are not fully functional directly after the battery is reconnected. The guidelines become fully functional after you drive your vehicle as straight as possible for five minutes at a minimum speed of 50 km/h (31 mph).

Parking Aids

The system uses three types of guidelines to help you see what is behind your vehicle:

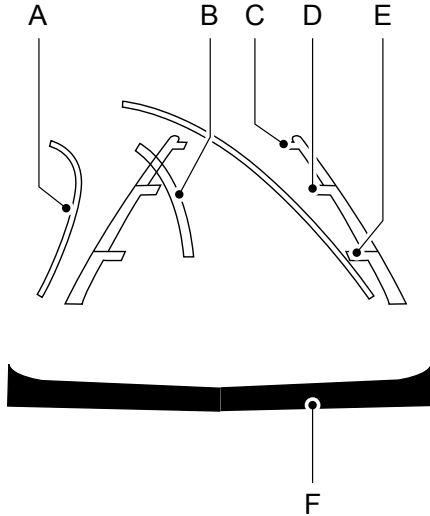

E142436

A Active guidelines. Show the

intended path of your vehicle when reversing.

- B Centerline. Helps you align the center of your vehicle with a trailer.
- C Fixed guidelines. Show the actual path of your vehicle when reversing in a straight line. Green zone.
- D Fixed guidelines. Show the actual path of your vehicle when reversing in a straight line. Yellow zone.
- E Fixed guidelines. Show the actual path of your vehicle when reversing in a straight line. Red zone.
- F Rear bumper.

Active guidelines are only available with fixed guidelines. To use active guidelines, turn the steering wheel to point the guidelines toward an intended path. If you change the steering wheel position when reversing, your vehicle might deviate from the original intended path.

Note: Guidelines do not display if the liftgate is open.

The fixed and active guidelines fade in and out depending on the steering wheel position. When the steering wheel position is straight the active guidelines do not display. Objects in the red zone are closest to your vehicle and objects in the green zone are further from your vehicle.

Manual Zoom

 **WARNING:** When manual zoom is on, the full area behind your vehicle may not show. Be aware of your surroundings when using the manual zoom feature.

Press the zoom in or zoom out symbol to change the view.

Note: Manual zoom is only available when you shift into reverse (R).

Note: The rear bumper remains in the image as a reference point.

Note: Only the centerline shows when you switch on manual zoom.

System Settings

You can adjust the camera settings using the touchscreen. See **Settings** (page 438).

Parking Aids

Rear View Camera Delay

You can switch this feature on or off using the touchscreen. The default setting is off. See **Settings** (page 438).

If you switch this feature on, the image continues to display when you shift from reverse (R) until:

- You shift to a forward gear and the vehicle speed sufficiently increases.
- You shift in to park (P).

Enhanced Parking Aids or Park Pilot

(If Equipped)

You can switch this feature on or off using the touchscreen. See **Settings** (page 438).

When the reverse sensing system detects an object, it displays red, yellow and green indicators at the top of the image.

Cruise Control

PRINCIPLE OF OPERATION

Cruise control lets you maintain a set speed without keeping your foot on the accelerator pedal. You can use cruise control when your vehicle speed is greater than 30 km/h (20 mph).

USING CRUISE CONTROL



WARNING: Do not use cruise control on winding roads, in heavy traffic or when the road surface is slippery. This could result in loss of vehicle control, serious injury or death.



WARNING: When you are going downhill, your vehicle speed could increase above the set speed. The system does not apply the brakes.

The cruise controls are on the steering wheel.

Switching Cruise Control On



Press the button.

Switching Cruise Control Off



Press the button when the system is in standby mode. The system also turns off when you switch the ignition off.

Note: *The set speed erases when you switch the system off.*

Setting the Cruise Speed

Drive to the required speed.



Press the toggle button upward or downward to set the current speed.



Take your foot off the accelerator pedal.

Note: *The set speed appears in the information display.*

Changing the Set Speed



Press the toggle button upward to increase the set speed.



Press the toggle button downward to decrease the set speed.

You can adjust the set speed in small or large increments. Press the toggle button upward or downward once to adjust the set speed in small increments. Press and hold the toggle button upward or downward to adjust the set speed in large increments.

Note: *If you accelerate by pressing the accelerator pedal, the set speed does not change. When you release the accelerator pedal, your vehicle returns to the speed that you previously set.*

Canceling the Set Speed



Press the button, or press the brake pedal to cancel the set speed.

Note: *The set speed is stored.*

Note: *The system cancels if the vehicle speed drops below 16 km/h (10 mph) under the set speed when driving uphill.*

Resuming the Set Speed



Press to resume the set speed.

Cruise Control

Cruise Control Indicator



The indicator appears when you switch the system on.

USING ADAPTIVE CRUISE CONTROL - VEHICLES WITH: ADAPTIVE CRUISE CONTROL

WARNING: You are responsible for controlling your vehicle at all times. The system is designed to be an aid and does not relieve you of your responsibility to drive with due care and attention. Failure to follow this instruction could result in the loss of control of your vehicle, personal injury or death.

WARNING: Pay close attention to changing road conditions such as entering or leaving a highway, on roads with intersections or roundabouts, roads without visible lanes of travel, roads that are winding, slippery, unpaved, or steep slopes.

WARNING: The system may not detect stationary or slow moving vehicles below 10 km/h (6 mph).

WARNING: Do not use the system when towing a trailer that has aftermarket electronic trailer brake controls. Failure to follow this instruction could result in the loss of control of your vehicle, personal injury or death.

WARNING: The system is not a crash warning or avoidance system.

WARNING: The system does not detect pedestrians or objects in the road.

WARNING: The system does not detect oncoming vehicles in the same lane.

WARNING: Do not use the system in poor visibility, for example fog, heavy rain, spray or snow.

WARNING: Do not use tire sizes other than those recommended because this can affect the normal operation of the system. Failure to do so may result in a loss of vehicle control, which could result in serious injury.

The system adjusts the vehicle speed to maintain the set gap between you and the vehicle in front of you in the same lane. You can select four gap settings.

The system uses a radar that projects a beam directly in front of your vehicle.



E248321

The adaptive cruise controls are on the steering wheel.

Switching Adaptive Cruise Control On



Press to set the system in standby mode.

Cruise Control



E260516

The indicator, current gap setting and set speed appear in the information display.

Setting the Adaptive Cruise Speed

Drive to the required speed.

SET+ Press the toggle button upward to set the current speed.

Take your foot off the accelerator pedal.

The indicator, current gap setting and set speed appear in the information display.



E249552

A vehicle graphic appears in the information display if the system detects a vehicle in front of you.

Note: When adaptive cruise control is active, the speedometer may vary slightly from the set speed displayed in the information display.

Following a Vehicle

WARNING: When following a vehicle that is braking, your vehicle does not always decelerate quickly enough to avoid a crash without driver intervention. Apply the brakes when necessary. Failure to follow this instruction could result in personal injury or death.

WARNING: The system only warns of vehicles detected by the radar sensor. In some cases there may be no warning or a delayed warning. Apply the brakes when necessary. Failure to follow this instruction could result in personal injury or death.

When a vehicle ahead of you enters the same lane or a slower vehicle is ahead in the same lane, the vehicle speed adjusts to maintain a preset gap distance. A vehicle graphic appears in the information display.

Note: When you are following a vehicle and you switch on a direction indicator, adaptive cruise control may provide a small temporary acceleration to help you pass.

Your vehicle maintains a consistent gap from the vehicle ahead until:

- The vehicle in front of you accelerates to a speed above the set speed.
- The vehicle in front of you moves out of the lane you are in.
- You set a new gap distance.

The system applies the brakes to slow your vehicle to maintain a safe gap distance from the vehicle in front. The system only applies limited braking. You can override the system by applying the brakes.

Cruise Control

If the system determines that its maximum braking level is not sufficient, an audible warning sounds when the system continues to brake. Take immediate action.

Note: *The brakes may emit noise when applied by the system.*

Setting the Gap Distance



You can decrease or increase the distance between your vehicle and the vehicle in front by pressing the gap control.

Note: *It is your responsibility to select a gap appropriate to the driving conditions.*



E249552

The selected gap appears in the information display as shown by the bars in the image. You can select four gap settings.

Adaptive Cruise Control Distance Between Vehicle Settings

Set Speed km/h (mph)	Graphic Display - Bars Indicated Between Vehicles	Time Gap - Seconds	Distance Gap m (yd)	Dynamic Behavior
100 (62)	1	1	28 (31)	Sport.
100 (62)	2	1.4	39 (43)	Normal.
100 (62)	3	1.8	50 (55)	Normal.
100 (62)	4	2.2	61 (67)	Comfort.

When you switch the ignition on, the system selects the last chosen gap setting.

Cruise Control

Overriding the System



WARNING: If you override the system by pressing the accelerator pedal, it does not automatically apply the brakes to maintain a gap from any vehicle ahead.

Use the accelerator pedal to intentionally exceed the set speed limit.

When you override the system, the vehicle graphic disappears from the information display.

Changing the Set Speed

SET+

Press the toggle button upward to increase the set speed.

SET-

Press the toggle button downward to decrease the set speed.

You can adjust the set speed in small or large increments. Press the toggle button upward or downward once to adjust the set speed in small increments. Press and hold the toggle button upward or downward to adjust the set speed in large increments.

The system may apply the brakes to slow your vehicle to the new set speed. The set speed continuously displays in the information display when the system is active.

Canceling the Set Speed

CAN

Press the button, or tap the brake pedal.

The last set speed displays with a strikethrough and the last gap setting appears but does not erase.

Note: The set speed also cancels if you press the clutch pedal for an extended period.

Resuming the Set Speed

RES

Press the button.

The vehicle speed returns to the previously set speed and gap setting. The set speed continuously shows in the information display when the system is active.

Note: Only use resume if you are aware of the set speed and intend to return to it.

Automatic Cancellation

The system does not operate if the vehicle speed is below 20 km/h (12 mph). A tone sounds and adaptive braking releases if the vehicle speed falls below 20 km/h (12 mph).

Automatic cancellation can also occur when:

- The tires lose traction.
- The engine speed is too low.
- You apply the parking brake.

Note: If the engine speed drops too low, the information display advises you to shift to a lower gear.

Hilly Condition Usage

Select a lower gear when the system is active and you are driving downhill on steep grades, for example in mountainous areas. The system needs additional engine braking in these situations to reduce the load on the brake system to prevent it from overheating.

Note: A tone sounds and the system turns off if it applies brakes for an extended period of time. This allows the brakes to cool. The system operates after the brakes cool.

Cruise Control

Switching Adaptive Cruise Control Off



Press the button.

Note: The set speed erases when you switch the system off.

Detection Issues



WARNING: On rare occasions, detection issues can occur due to the road infrastructures, for example bridges, tunnels and safety barriers. In these cases, the system may brake late or unexpectedly. At all times, you are responsible for controlling your vehicle, supervising the system and intervening, if required.



WARNING: If the system malfunctions, have your vehicle checked as soon as possible.

The radar has a limited field of view. It does not detect all vehicles in all situations and could detect vehicles later than you expect. The lead vehicle graphic does not display if the system does not detect a vehicle in front of you.

A

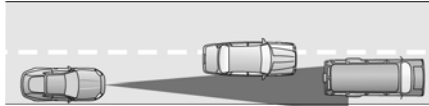

B



C

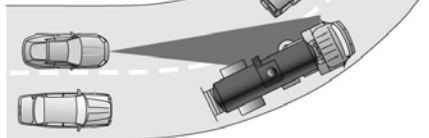

Detection issues can occur:

- A When driving on a different line than the vehicle in front.
- B With vehicles that edge into your lane. The system can only detect these vehicles once they fully move into your lane.
- C There may be issues with the detection of vehicles in front when driving into and coming out of a bend or curve in the road.

In these cases, the system may brake late or unexpectedly. You should stay alert and take action when necessary.

If something hits the front of your vehicle or damage occurs, the radar-sensing zone may change. This could cause the system to malfunction. Have your vehicle checked as soon as possible.

System Not Available

The system may not turn on if there is:

- A blocked sensor.
- High brake temperature.
- A failure in the system or a related system.

Cruise Control

Adaptive Cruise Control System Sensors

 **WARNING:** The system may not operate properly if the sensor is blocked. Keep the windshield free from obstruction.



E243054

The camera is mounted behind the interior mirror.



E244279

The radar is behind the front grille below the license plate.

A message displays if something obstructs the radar signals from the sensor. The system cannot detect a vehicle ahead and does not function when something blocks the sensor.

Note: You cannot see the sensor, it is behind a fascia panel.

Note: Keep the front of your vehicle free of dirt, metal badges or objects. Vehicle front protectors, aftermarket lights, additional paint or plastic coatings could also degrade sensor performance.

Cruise Control

Cause	Action
The surface of the radar in the radiator grille is dirty or obstructed.	Clean the radiator grille in front of the radar or remove any obstruction.
The surface of the radar is clean but the message remains in the display.	Wait a short period of time. It may take several minutes for the radar to detect that it is free from obstruction.
Heavy rain or snow interfere with the radar signals.	Do not use the system in these conditions because it may not detect any vehicles ahead.
Swirling water, snow or ice on the surface of the road interfere with the radar signals.	Do not use the system in these conditions because it may not detect any vehicles ahead.
You are in a desert or remote area with no other vehicles and no roadside objects.	Wait a short period of time or switch to normal cruise control.

Due to the nature of radar technology, a blocked sensor message could display when the sensor is not blocked. This can happen, for example, when driving in sparse rural or desert environments. A false blocked condition self clears or clears after you switch the ignition off and on.

Switching to Normal Cruise Control

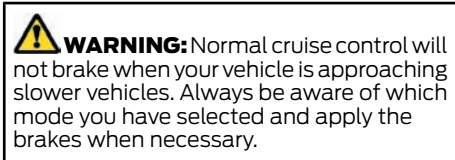

You can change from adaptive cruise control to cruise control using the information display.

Cruise Control

To switch between adaptive cruise control and normal cruise control, use the information display controls on the steering wheel to select the following:

Menu Item	Action
Driver assist.	Press the menu button.
Cruise control	Press the OK button.
Mode	Press the OK button. Press the toggle button upward or downward to choose your required setting. Press the OK button.



The cruise control indicator replaces the adaptive cruise control indicator if you select normal cruise control. The gap setting does not display, the system does not automatically respond to lead vehicles and adaptive braking does not activate. The system remembers the last setting when you start your vehicle.

Adaptive Cruise Control Indicator



The indicator appears when you switch the system on.

The indicator appears in the information display when the system is in standby mode and when you set the adaptive cruise speed.

Cruise Control

Adaptive Cruise Control Information Messages

Message	Action
Adaptive cruise control not available Sensor blocked See manual	The radar has reduced visibility.
Adaptive cruise control not available	The system is not available.
Adaptive cruise control malfunction	The system has malfunctioned. Have your vehicle checked as soon as possible.
Cruise control active Adaptive braking off	You have switched normal cruise control on. Adaptive braking turns off.

Adaptive Cruise Control With Speed Sign Recognition (If Equipped)



WARNING: You are responsible for controlling your vehicle at all times. The system is designed to be an aid and does not relieve you of your responsibility to drive with due care and attention. Failure to follow this instruction could result in the loss of control of your vehicle, personal injury or death.

The system combines speed sign recognition with adaptive cruise control. The system allows you to set the vehicle speed to the speed limit detected by the speed sign recognition system. For example, if the speed sign recognition system detects a 80 km/h (50 mph) speed limit, the vehicle speed is set to 80 km/h (50 mph).

Note: *The system does not set the vehicle speed to speed limits shown with a supplementary traffic sign in the information display.*

Note: *You can override the set speed at any time.*

Note: *The adaptive cruise control gap setting normally operates.*

Switching Between the Cruise Control Modes

You can change between the cruise control modes using the information display.

Cruise Control

To switch between the cruise control modes, use the information display controls on the steering wheel to select the following:

Menu Item	Action
Driver assist.	Press the menu button.
Cruise control	Press the OK button.
Mode	Press the OK button. Press the toggle button upward or downward to choose your required setting. Press the OK button.

Intelligent Mode



E265663

If you select this mode, a bracket appears around the set speed and the detected speed limit sign in the information display. The system is designed to set the vehicle speed to the speed limit detected by the speed sign recognition system before your vehicle passes the speed limit sign.

Under certain conditions, the system may not adjust the vehicle speed until after your vehicle passes the speed limit sign.

Note: *The set speed adjusts when the system detects a different maximum speed limit.*

If the system does not detect a speed limit, the vehicle speed remains at the current set speed.

Automatic Cancellation

If the speed sign recognition system detects a speed limit below the minimum adaptive cruise control set speed, a tone sounds and the system returns to standby mode.

Adjusting the Set Speed Tolerance Settings

You can set a permanent speed tolerance that is above or below the detected speed limit through the tolerance menu in the information display.

Cruise Control

To adjust the speed tolerance setting, use the information display controls on the steering wheel to select the following:

Menu Item	Action
Driver assist.	Press the menu button.
Cruise control	Press the OK button.
Tolerance	Press the OK button. Press the toggle button upward or downward to choose your required speed setting. Press the OK button.

Adaptive Mode

If you select this mode, adaptive cruise control operates with manual set speed input. The system does not set the vehicle speed to the speed limit detected by the speed sign recognition system.

Normal Mode

If you select this mode, normal cruise control operates. The gap setting does not display, the system does not automatically respond to lead vehicles and adaptive braking does not activate.

Adaptive Cruise Control With Speed Sign Recognition Information Messages

Message	Action
Adaptive cruise control Speed sign recognition not available	Navigation system based speed limit information is not available. If the message continues to appear, have your vehicle checked as soon as possible.

Cruise Control

USING ADAPTIVE CRUISE CONTROL - VEHICLES WITH: ADAPTIVE CRUISE CONTROL WITH STOP AND GO

WARNING: You are responsible for controlling your vehicle at all times. The system is designed to be an aid and does not relieve you of your responsibility to drive with due care and attention. Failure to follow this instruction could result in the loss of control of your vehicle, personal injury or death.

WARNING: Pay close attention to changing road conditions such as entering or leaving a highway, on roads with intersections or roundabouts, roads without visible lanes of travel, roads that are winding, slippery, unpaved, or steep slopes.

WARNING: The system may not detect stationary or slow moving vehicles below 10 km/h (6 mph).

WARNING: Do not use the system when towing a trailer that has aftermarket electronic trailer brake controls. Failure to follow this instruction could result in the loss of control of your vehicle, personal injury or death.

WARNING: The system is not a crash warning or avoidance system.

WARNING: The system does not detect pedestrians or objects in the road.

WARNING: The system does not detect oncoming vehicles in the same lane.

WARNING: Do not use the system in poor visibility, for example fog, heavy rain, spray or snow.

WARNING: Do not use tire sizes other than those recommended because this can affect the normal operation of the system. Failure to do so may result in a loss of vehicle control, which could result in serious injury.

The system adjusts the vehicle speed to maintain the set gap between you and the vehicle in front of you in the same lane. You can select four gap settings.

The system uses a radar that projects a beam directly in front of your vehicle.



E248321

The adaptive cruise controls are on the steering wheel.

Switching Adaptive Cruise Control On



Press to set the system in standby mode.

Cruise Control



E260516

The indicator, current gap setting and set speed appear in the information display.

Setting the Adaptive Cruise Speed

Drive to the required speed.

SET+ Press the toggle button upward to set the current speed.

Take your foot off the accelerator pedal.

The indicator, current gap setting and set speed appear in the information display.



E249552

A vehicle graphic appears in the information display if the system detects a vehicle in front of you.

Note: When adaptive cruise control is active, the speedometer may vary slightly from the set speed displayed in the information display.

Setting the Adaptive Cruise Speed When Your Vehicle is Stationary

1. Follow a vehicle to a complete stop.
2. Keep the brake pedal fully pressed.
3. Press and release **SET+** or **SET-**.

The set speed adjusts to 30 km/h (20 mph).

The indicator, current gap setting and set speed appear in the information display.

Following a Vehicle

WARNING: When following a vehicle that is braking, your vehicle does not always decelerate quickly enough to avoid a crash without driver intervention. Apply the brakes when necessary. Failure to follow this instruction could result in personal injury or death.

WARNING: The system only warns of vehicles detected by the radar sensor. In some cases there may be no warning or a delayed warning. Apply the brakes when necessary. Failure to follow this instruction could result in personal injury or death.

When a vehicle ahead of you enters the same lane or a slower vehicle is ahead in the same lane, the vehicle speed adjusts to maintain a preset gap distance. A vehicle graphic appears in the information display.

Note: When you are following a vehicle and you switch on a direction indicator, adaptive cruise control may provide a small temporary acceleration to help you pass.

Cruise Control

Your vehicle maintains a consistent gap from the vehicle ahead until:

- The vehicle in front of you accelerates to a speed above the set speed.
- The vehicle in front of you moves out of the lane you are in.
- You set a new gap distance.

The system applies the brakes to slow your vehicle to maintain a safe gap distance from the vehicle in front. The system only applies limited braking. You can override the system by applying the brakes.

If the system determines that its maximum braking level is not sufficient, an audible warning sounds when the system continues to brake. Take immediate action.

Following a Vehicle to a Complete Stop

Vehicles With: Adaptive Cruise Control With Stop and Go

If your vehicle follows a vehicle to a complete stop and remains stationary for less than three seconds, your vehicle accelerates from a stationary position to follow the vehicle ahead.

If your vehicle follows a vehicle to a complete stop and remains stationary for more than three seconds, press **RES** or the accelerator pedal to follow the vehicle ahead.

Note: *The brakes may emit noise when applied by the system.*

Setting the Gap Distance



You can decrease or increase the distance between your vehicle and the vehicle in front by pressing the gap control.

Note: *It is your responsibility to select a gap appropriate to the driving conditions.*



The selected gap appears in the information display as shown by the bars in the image. You can select four gap settings.

Cruise Control

Adaptive Cruise Control Distance Between Vehicle Settings

Set Speed km/h (mph)	Graphic Display - Bars Indicated Between Vehicles	Time Gap - Seconds	Distance Gap m (yd)	Dynamic Behavior
100 (62)	1	1	28 (31)	Sport.
100 (62)	2	1.4	39 (43)	Normal.
100 (62)	3	1.8	50 (55)	Normal.
100 (62)	4	2.2	61 (67)	Comfort.

When you switch the ignition on, the system selects the last chosen gap setting.

Overriding the System



WARNING: If you override the system by pressing the accelerator pedal, it does not automatically apply the brakes to maintain a gap from any vehicle ahead.

Use the accelerator pedal to intentionally exceed the set speed limit.

When you override the system, the vehicle graphic disappears from the information display.

Changing the Set Speed



Press the toggle button upward to increase the set speed.



Press the toggle button downward to decrease the set speed.

You can adjust the set speed in small or large increments. Press the toggle button upward or downward once to adjust the set speed in small increments. Press and hold the toggle button upward or downward to adjust the set speed in large increments.

The system may apply the brakes to slow your vehicle to the new set speed. The set speed continuously displays in the information display when the system is active.

Canceling the Set Speed



Press the button once or tap the brake pedal.

The last set speed displays with a strikethrough and the last gap setting appears but does not erase.

Cruise Control

Resuming the Set Speed



Press the button.

The vehicle speed returns to the previously set speed and gap setting. The set speed continuously shows in the information display when the system is active.

Note: Only use resume if you are aware of the set speed and intend to return to it.

Automatic Cancellation



WARNING: When your vehicle is stationary and automatic cancellation occurs, a warning tone sounds and the brakes are released. Apply the brakes to keep your vehicle stationary. Failure to follow this instruction could result in the loss of control of your vehicle, personal injury or death.

The system cancels if any of the following occur:

- You apply the parking brake.
- You unfasten the seatbelt if your vehicle is stationary.

- Your vehicle remains stationary for longer than three minutes.
- The tires lose traction.

Hilly Condition Usage

Select a lower gear when the system is active and you are driving downhill on steep grades, for example in mountainous areas. The system needs additional engine braking in these situations to reduce the load on the brake system to prevent it from overheating.

Note: A tone sounds and the system turns off if it applies brakes for an extended period of time. This allows the brakes to cool. The system operates after the brakes cool.

Switching Adaptive Cruise Control Off



Press the button once with the system in standby mode.

Note: The set speed erases when you switch the system off.

Detection Issues



WARNING: On rare occasions, detection issues can occur due to the road infrastructures, for example bridges, tunnels and safety barriers. In these cases, the system may brake late or unexpectedly. At all times, you are responsible for controlling your vehicle, supervising the system and intervening, if required.



WARNING: If the system malfunctions, have your vehicle checked as soon as possible.

The radar has a limited field of view. It does not detect all vehicles in all situations and could detect vehicles later than that you expect. The lead vehicle graphic does not display if the system does not detect a vehicle in front of you.

Cruise Control

A

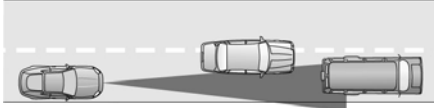

B

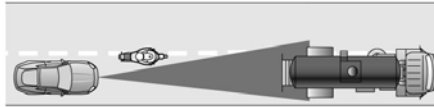

C

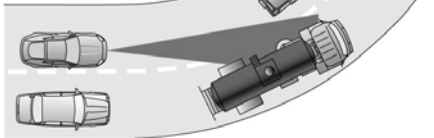

Detection issues can occur:

- A When driving on a different line than the vehicle in front.
- B With vehicles that edge into your lane. The system can only detect these vehicles once they fully move into your lane.
- C There may be issues with the detection of vehicles in front when driving into and coming out of a bend or curve in the road.

In these cases, the system may brake late or unexpectedly. You should stay alert and take action when necessary.

If something hits the front of your vehicle or damage occurs, the radar-sensing zone may change. This could cause missed or false vehicle detection

System Not Available

- A blocked sensor.
- High brake temperature.
- A failure in the system or a related system.
- The system does not detect a lead vehicle after you stop, or driving at low speeds.

Adaptive Cruise Control System Sensors

 **WARNING:** The system may not operate properly if the sensor is blocked. Keep the windshield free from obstruction.



E243054

The camera is mounted behind the interior mirror.

Cruise Control



The radar is behind the front grille below the license plate.

A message displays if something obstructs the radar signals from the sensor. The system cannot detect a vehicle ahead and does not function when something blocks the sensor.

Note: You cannot see the sensor, it is behind a fascia panel.

Note: Keep the front of your vehicle free of dirt, metal badges or objects. Vehicle front protectors, aftermarket lights, additional paint or plastic coatings could also degrade sensor performance.

E244279

Cause	Action
The surface of the radar in the radiator grille is dirty or obstructed.	Clean the radiator grille in front of the radar or remove any obstruction.
The surface of the radar is clean but the message remains in the display.	Wait a short period of time. It may take several minutes for the radar to detect that it is free from obstruction.
Heavy rain or snow interfere with the radar signals.	Do not use the system in these conditions because it may not detect any vehicles ahead.
Swirling water, snow or ice on the surface of the road interfere with the radar signals.	Do not use the system in these conditions because it may not detect any vehicles ahead.
You are in a desert or remote area with no other vehicles and no roadside objects.	Wait for a short period of time or switch to normal cruise control.

Cruise Control

Due to the nature of radar technology, a blocked sensor message could display when the sensor is not blocked. This can happen, for example, when driving in sparse rural or desert environments. A false blocked condition self clears or clears after you switch the ignition off and on.

Switching to Normal Cruise Control

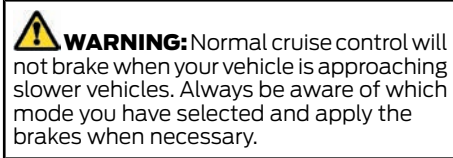

You can change from adaptive cruise control to cruise control using the information display.

To switch between adaptive cruise control and normal cruise control, use the information display controls on the steering wheel to select the following:

Menu Item	Action
Driver assist.	Press the menu button.
Cruise control	Press the OK button.
Mode	Press the OK button. Press the toggle button upward or downward to choose your required setting. Press the OK button.



The cruise control indicator replaces the adaptive cruise control indicator if you select normal cruise control. The gap setting does not display, the system does not automatically respond to lead vehicles and adaptive braking does not activate. The system remembers the last setting when you start your vehicle.

Adaptive Cruise Control Indicator



The indicator appears when you switch the system on.

The indicator appears in the information display when the system is in standby mode and when you set the adaptive cruise speed.

Cruise Control

Adaptive Cruise Control Information Messages

Message	Action
Adaptive cruise control not available Sensor blocked See manual	The radar has reduced visibility.
Adaptive cruise control not available	The system is not available.
Adaptive cruise control malfunction	The system has malfunctioned. Have your vehicle checked as soon as possible.
Adaptive cruise control Speed too low to activate	You have switched the system on when your vehicle speed is too low.
Cruise control active Adaptive braking off	You have switched normal cruise control on. Adaptive braking turns off.

Adaptive Cruise Control With Speed Sign Recognition (If Equipped)



WARNING: You are responsible for controlling your vehicle at all times. The system is designed to be an aid and does not relieve you of your responsibility to drive with due care and attention. Failure to follow this instruction could result in the loss of control of your vehicle, personal injury or death.

The system combines speed sign recognition with adaptive cruise control. The system allows you to set the vehicle speed to the speed limit detected by the speed sign recognition system. For example, if the speed sign recognition system detects a 80 km/h (50 mph) speed limit, the vehicle speed is set to 80 km/h (50 mph).

Note: *The system does not set the vehicle speed to speed limits shown with a supplementary traffic sign in the information display.*

Note: *You can override the set speed at any time.*

Note: *The adaptive cruise control gap setting normally operates.*

Switching Between the Cruise Control Modes

You can change between the cruise control modes using the information display.

Cruise Control

To switch between the cruise control modes, use the information display controls on the steering wheel to select the following:

Menu Item	Action
Driver assist.	Press the menu button.
Cruise control	Press the OK button.
Mode	Press the OK button. Press the toggle button upward or downward to choose your required setting. Press the OK button.

Intelligent Mode



E265663

If you select this mode, a bracket appears around the set speed and the detected speed limit sign in the information display. The system is designed to set the vehicle speed to the speed limit detected by the speed sign recognition system before your vehicle passes the speed limit sign.

Under certain conditions, the system may not adjust the vehicle speed until after your vehicle passes the speed limit sign.

Note: *The set speed adjusts when the system detects a different maximum speed limit.*

If the system does not detect a speed limit, the vehicle speed remains at the current set speed.

Automatic Cancellation

If the speed sign recognition system detects a speed limit below the minimum adaptive cruise control set speed, a tone sounds and the system returns to standby mode.

Adjusting the Set Speed Tolerance Settings

You can set a permanent speed tolerance that is above or below the detected speed limit through the tolerance menu in the information display.

Cruise Control

To adjust the speed tolerance setting, use the information display controls on the steering wheel to select the following:

Menu item	Description and action
Driver assist.	Press the menu button.
Cruise control	Press the OK button.
Tolerance	Press the OK button. Press the toggle button upward or downward to choose your required speed setting. Press the OK button.

Adaptive Mode

If you select this mode, adaptive cruise control operates with manual set speed input. The system does not set the vehicle speed to the speed limit detected by the speed sign recognition system.

Normal Mode

If you select this mode, normal cruise control operates. The gap setting does not display, the system does not automatically respond to lead vehicles and adaptive braking does not activate.

Adaptive Cruise Control With Speed Sign Recognition Information Messages

Message	Action
Adaptive cruise control Speed sign recognition not available	Navigation system based speed limit information is not available. If the message continues to appear, have your vehicle checked as soon as possible.

Driving Aids

SPEED LIMITER

Principle of Operation



WARNING: When you are going downhill, your vehicle speed could increase above the set speed. The system does not apply the brakes.



WARNING: The system is designed to aid the driver. It is not intended to replace your attention and judgment. You are still responsible to drive with due care and attention.

The system allows you to set a speed to which your vehicle becomes limited. The set speed sets the effective maximum speed of your vehicle. You can temporarily exceed the set speed if required, for example to overtake.

Using Speed Limiter

The controls are on the steering wheel.

Switching the System On and Off

LIM

Press to set the system in standby mode. Press again to switch the system off.

Setting the Speed Limiter

SET+

Press the toggle button upward or downward with the system in standby mode to set the speed limiter to the current vehicle speed.

SET-

The set speed is stored and displayed in the information

display.

You can adjust the set speed in small or large increments. Press the toggle button upward or downward once to adjust the set speed in small increments. Press and hold the toggle button upward or downward to adjust the set speed in large increments.

Canceling the Set Speed

CAN

Press to cancel the set speed limiter. The system returns to standby mode.

Resuming the Set Speed

RES

Press to resume the set speed limiter.

Intentionally Exceeding the Speed Limit

Firmly press the accelerator pedal to temporarily exceed the set speed limit. The system resumes when the vehicle speed drops below the set speed limit, or when you press the **RES** button.

System Warnings

If you intentionally exceed the set speed, a warning appears in the information display.

If you unintentionally exceed the set speed, for example when you are going downhill, a warning appears in the information display and a tone sounds.

INTELLIGENT SPEED LIMITER

Principle of Operation



WARNING: When you are going downhill, your vehicle speed could increase above the set speed. The system does not apply the brakes.

Driving Aids



WARNING: You are responsible for controlling your vehicle at all times. The system is designed to be an aid and does not relieve you of your responsibility to drive with due care and attention. Failure to follow this instruction could result in the loss of control of your vehicle, personal injury or death.

The system allows you to limit the vehicle speed to the maximum speed limit detected by the speed sign recognition system. For example, if the speed sign recognition system detects a 80 km/h (50 mph) speed limit, the vehicle speed is limited to 80 km/h (50 mph). You can temporarily exceed the set speed if required, for example to overtake.

Note: The system does not limit the vehicle speed to speed limits shown with a supplementary traffic sign in the information display.

Using Intelligent Speed Limiter

The controls are on the steering wheel.

Switching the System On or Off

LIM

Press to switch the system on. The system activates with the detected speed-limit or, if no speed-limit is detected, the current vehicle speed as the set speed. Press again to switch the system off.

Setting the Speed Limiter

SET+

Press the toggle button upward or downward with the system in standby mode to set the speed limiter to the current vehicle speed.

SET-

The set speed is stored and displayed in the information display.

Note: The set speed limiter adjusts when the system detects a different maximum speed limit.

Note: If the system cannot detect a maximum speed limit, the system returns to standby mode.

You can adjust the set speed in small or large increments. Press the toggle button upward or downward once to adjust the set speed in small increments. Press and hold the toggle button upward or downward to adjust the set speed in large increments.

Canceling the Set Speed

CAN

Press to cancel the set speed limiter. The system returns to standby mode.

Note: The speed limiter icon and the set speed indicator are greyed out in standby mode.

Note: The system does not limit the vehicle speed in standby mode.

Resuming the Set Speed

RES

Press to resume the set speed limiter. The system sets the speed limiter to the detected maximum speed limit at the time it resumes.

Intentionally Exceeding the Speed Limit

Firmly press the accelerator pedal to temporarily exceed the set speed limit. The system resumes when the vehicle speed drops below the set speed limit, or when you press the **RES** button.

Driving Aids

System Warnings

A warning appears in the information display if any of the following occur:

- The vehicle speed exceeds the current set speed.
- The system detects a maximum speed limit that is lower than the current vehicle speed.

- You intentionally exceed the set speed.
- You unintentionally exceed the set speed, for example when you are going downhill. A tone also sounds.

Note: *A tone sounds if you continue to exceed the set speed.*

Note: *If the speed sign recognition system detects a speed limit outside the operational speed range, a tone sounds and the system returns to standby mode.*

Adjusting Intelligent Speed Limiter Tolerance Settings

You can set a permanent speed tolerance that is in addition to the detected speed limit through the tolerance menu in the information display.

To adjust the speed tolerance setting, use the information display controls on the steering wheel to select the following:

Menu Item	Action
Driver assist.	Press the menu button.
Speed limiter	Press the OK button.
Intelligent	Press the OK button.
Tolerance	Press the OK button. Press the toggle button upward or downward to choose your required speed setting. Press the OK button.

Driving Aids

Switching to Normal Speed Limiter

You can change between intelligent speed limiter and normal speed limiter using the information display. Intelligent speed limiter

allows you to limit the vehicle speed to the maximum speed limit detected by the speed sign recognition system. Normal speed limiter allows you to manually limit the vehicle speed using controls on the steering wheel.

To switch between intelligent speed limiter and normal speed limiter, use the information display controls on the steering wheel to select the following:

Menu Item	Action
Driver assist.	Press the menu button.
Speed limiter	Press the OK button.
Intelligent	Press the OK button.

Note: *If you switch intelligent speed limiter off, the system defaults to manual speed limiter. You can manually set the speed limiter using the controls on the steering wheel.*

DRIVER ALERT

 **WARNING:** The system is designed to aid the driver. It is not intended to replace your attention and judgment. You are still responsible to drive with due care and attention.

 **WARNING:** At all times, you are responsible for controlling your vehicle, supervising the system and intervening, if required. Failure to take care may result in the loss of control of your vehicle, serious personal injury or death.

 **WARNING:** The system may not operate properly if the sensor is blocked. Keep the windshield free from obstruction.

 **WARNING:** Take regular rest breaks if you feel tired. Do not wait for the system to warn you.

 **WARNING:** Certain driving styles may result in the system warning you even if you are not feeling tired.

 **WARNING:** In cold and severe weather conditions the system may not function. Rain, snow and spray can all limit sensor performance.

 **WARNING:** The system will not operate if the sensor cannot track the road lane markings.

Driving Aids

 **WARNING:** If damage occurs in the immediate area surrounding the sensor, have your vehicle checked as soon as possible.

 **WARNING:** The system may not correctly operate if your vehicle is fitted with a suspension kit not approved by us.

The system is designed to alert you if it detects that you are becoming drowsy or if your driving deteriorates. The system calculates your alertness level based upon your driving behavior in relation to the lane markings and other factors when the vehicle speed is greater than approximately 65 km/h (40 mph).

You can switch the system on or off using the information display. See **General Information** (page 116).

Note: *The system remains on or off depending on how it was last set.*

System Warnings

The warning system has two stages:

1. A temporary warning is issued to advise you to take a rest. This message only appears for a short time.
2. If you do not rest and the system continues to detect that your driving deteriorates, it issues a further warning. This remains in the information display until you cancel it. See **Information Messages** (page 121).

Note: *The system does not warn you if the vehicle speed falls below approximately 65 km/h (40 mph).*

System Display

Your calculated alertness level is shown by six steps as a colored bar. The bar travels from right to left as your calculated alertness level decreases.

You can view the status at any time using the information display. See **General Information** (page 116).

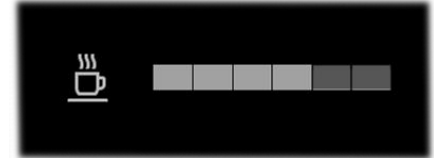

E249476

Your calculated alertness level is good.



E249477

Your calculated alertness level is low. You should stop your vehicle and take a rest as soon as it is safe to do so.

Your calculated alertness level shows in gray if:

- The sensor cannot track the road lane markings.
- The vehicle speed falls below approximately 65 km/h (40 mph).

Driving Aids

Resetting the System

You can reset the system by:

- Switching the ignition off and on when your vehicle is stationary.
- Opening and closing the driver door when your vehicle is stationary.

LANE KEEPING SYSTEM

 **WARNING:** You are responsible for controlling your vehicle at all times. The system is designed to be an aid and does not relieve you of your responsibility to drive with due care and attention. Failure to follow this instruction could result in the loss of control of your vehicle, personal injury or death.

 **WARNING:** The system may not function if the sensor is blocked.

 **WARNING:** The sensor may incorrectly track lane markings as other structures or objects. This can result in a false or missed warning.

 **WARNING:** In cold and severe weather conditions the system may not function. Rain, snow and spray can all limit sensor performance.

 **WARNING:** Large contrasts in outside lighting can limit sensor performance.

 **WARNING:** The system will not operate if the sensor cannot track the road lane markings.

 **WARNING:** If damage occurs in the immediate area surrounding the sensor, have your vehicle checked as soon as possible.

 **WARNING:** The system may not correctly operate if your vehicle is fitted with a suspension kit not approved by us.

The system is designed to alert you by providing temporary steering assistance or steering wheel vibration when it detects an unintended lane departure. The system detects and tracks the road lane markings using a camera mounted behind the interior mirror. The system only operates when the vehicle speed is greater than approximately 65 km/h (40 mph). You can view the system status in the information display.

Note: *The system works when the camera can detect at least one lane marking or the edge of the road.*

The system may not correctly operate in any of the following conditions:

- The system does not detect at least one lane marking or the edge of the road.
- You switch the direction indicator on.
- You apply direct steering, accelerate fast or brake hard.
- The vehicle speed is less than 65 km/h (40 mph).
- The anti-lock brake, stability control or traction control system activates.
- Narrow lane width.

Driving Aids

The system may not correct lane positioning in any of the following conditions:

- High winds.
- Uneven road surfaces.
- Heavy or uneven loads.
- Incorrect tire pressure.

Switching Lane Keeping System On and Off



E270719

Press the button on the direction indicator stalk.

Lane Keeping System Settings

The system has different settings that you can view or adjust using the information display.

Note: *The system remembers the last setting when you start your vehicle. If the system detects a MyKey, the mode is set to alert.*

Alert Mode

Provides steering wheel vibration when the system detects an unintended lane departure.

Adjusting the Steering Wheel Vibration Intensity

1. Using the information display controls on the steering wheel, select **Driver assist..**
2. Select **Lane keeping system.**
3. Select **Intensity.**
4. Select a setting and press the **OK** button.

Note: *This setting does not affect the aid mode.*

Note: *The system remembers the last setting when you start your vehicle.*

Adjusting the Lane Keeping System Sensitivity

1. Using the information display controls on the steering wheel, select **Driver assist..**
2. Select **Lane keeping system.**
3. Select **Sensitivity.**
4. Select a setting and press the **OK** button.

Aid Mode

Provides temporary steering assistance toward the lane center when the system detects an unintended lane departure.

Note: *When aid mode is on and the system does not detect any steering activity for a short period of time, for example lightly holding the steering wheel, the system alerts you to put your hands on the steering wheel.*

Note: *The aid mode becomes active again after you have returned your vehicle to the center of the lane.*

Alert and Aid Mode

Provides temporary steering assistance toward the lane center when the system detects an unintended lane departure. If your vehicle continues drifting out of the lane, the steering wheel vibrates.

Driving Aids

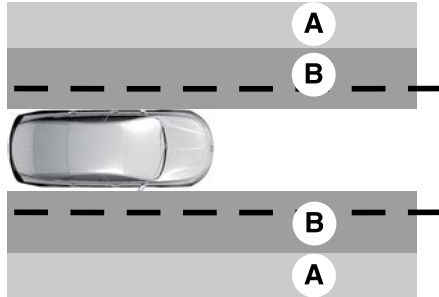

A Alert mode.

B Aid mode.

Note: The diagram illustrates general zone coverage. It does not provide exact zone parameters.

Switching the Lane Keeping System Mode

1. Using the information display controls on the steering wheel, select **Driver assist**.
2. Select **Lane keeping system**.
3. Select **Mode**.
4. Select a setting and press the **OK** button.

Lane Keeping System Display



When the system is off, the system indicator or the lane markings do not display.

Lane Keeping System Indicators



It illuminates in the information display when you switch the system on and Aid Mode or Alert and Aid Mode are selected.



It illuminates in the information display when you switch the system on and Alert Mode is selected.

Black and White Information Display

Indicator	System Status
Gray.	Unavailable.
White.	Available.
White and inverted.	Temporary steering assistance.
White and flashing.	Temporary steering assistance and steering wheel vibration.

Driving Aids

Color Information Display

Indicator	System Status
Gray.	Unavailable.
Green.	Available.
Amber.	Temporary steering assistance.
Red.	Temporary steering assistance and steering wheel vibration.

Lane Keeping System Warning Lamp



It could illuminate when you switch the system off. If it illuminates when you are driving, this indicates a malfunction. Have your vehicle checked as soon as possible.

Lane Keeping System Messages

Message	Action
Lane keeping system malfunction Service required	The system has detected a fault that requires service. Have your vehicle checked as soon as possible.

Driving Aids

BLIND SPOT INFORMATION SYSTEM

WARNING: Do not use the blind spot information system as a replacement for using the interior and exterior mirrors or looking over your shoulder before changing lanes. The blind spot information system is not a replacement for careful driving.

WARNING: The system may not operate properly during severe weather conditions, for example snow, ice, heavy rain and spray. Always drive with due care and attention. Failure to take care may result in a crash.

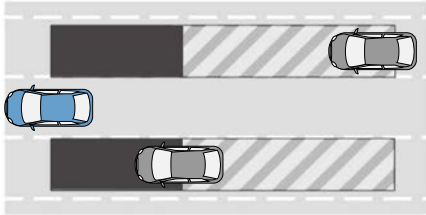

The system is designed to detect vehicles that may have entered the blind spot zone. The detection area is on both sides of your vehicle, extending rearward from the exterior mirrors to approximately 4 m (13 ft) beyond the rear bumper. The detection area extends to approximately 18 m (59 ft) beyond the rear bumper when the vehicle speed is greater than 48 km/h (30 mph) to alert you of faster approaching vehicles.

Note: *The system does not prevent contact with other vehicles. It is not designed to detect parked vehicles, pedestrians, animals or other infrastructures.*

Using the Blind Spot Information System

Vehicles with Automatic Transmission

The system turns on when all of the following occur:

- You start your vehicle.
- You shift into drive (D).
- The vehicle speed is greater than 10 km/h (6 mph).

Note: *The system does not operate in park (P) or reverse (R).*

Vehicles with Manual Transmission

The system turns on when all of the following occur:

- You start your vehicle.
- The vehicle speed is greater than 10 km/h (6 mph).

Note: *The system does not operate in reverse (R).*

Blind Spot Information System Sensors



The sensors are behind the rear bumper on both sides of your vehicle.

Note: *Keep the sensors free from snow, ice and large accumulations of dirt.*

Note: *Do not cover the sensors with bumper stickers, repair compound or other objects.*

Driving Aids

Note: Blocked sensors could affect system performance.

If the sensors are blocked, a message may appear in the information display. The alert indicators remain illuminated but the system does not alert you.

Switching the Blind Spot Information System On and Off

1. Using the information display controls on the steering wheel, select **Settings**.
2. Select **Driver assistance**.
3. Switch **BLIS** on or off.

If you switch the system off, a warning lamp illuminates and a message displays. When you switch the system on or off, the alert indicators flash twice.

Note: The system remembers the last setting when you start your vehicle.

Note: The system may not correctly operate when towing a trailer. For vehicles with a trailer tow module and tow bar approved by us, the system turns off when you attach a trailer. For vehicles with an aftermarket trailer tow module or tow bar, we recommend that you switch the system off when you attach a trailer.

To permanently switch the system off, contact an authorized dealer.

Blind Spot Information System Indicator



When the system detects a vehicle, an alert indicator illuminates in the exterior mirror on the side the approaching vehicle is coming from. If you turn the direction indicator on for that side of your vehicle, the alert indicator flashes.

If the system detects a fault, an indicator illuminates in the instrument cluster and a message appears in the information display. Have your vehicle checked as soon as possible.

Note: The system may not alert you if a vehicle quickly passes through the detection zone.

Blind Spot Information System Information Messages

Message	Action
BLIS not available Sensor blocked See manual	Displays if the blind spot information system sensors are blocked.
BLIS deactivated Trailer attached	Displays if you attach a trailer to your vehicle.
BLIS malfunction	The system has detected a fault that requires service. Have your vehicle checked as soon as possible.

Driving Aids

CROSS TRAFFIC ALERT



WARNING: Do not use the cross traffic alert system as a replacement for using the interior and exterior mirrors or looking over your shoulder before reversing out of a parking space. The cross traffic alert system is not a replacement for careful driving.



WARNING: The system may not operate properly during severe weather conditions, for example snow, ice, heavy rain and spray. Always drive with due care and attention. Failure to take care may result in a crash.

The system is designed to alert you of vehicles approaching from the sides behind your vehicle when you shift into reverse (R). If you continue to reverse after the system alerts you, the system is designed to apply the brakes if it still detects an approaching vehicle. If the system applies the brakes, a message appears in the information display.

Note: *The system does not apply the brakes if you override it by firmly pressing the accelerator pedal.*

Using Cross Traffic Alert

The system is designed to detect vehicles that approach at a speed between 6 km/h (4 mph) and 60 km/h (37 mph). Coverage decreases when the sensors are partially, mostly or fully obstructed. Slowly reversing helps increase the coverage area and effectiveness.

The system turns on when you start the engine and you shift into reverse (R). The system turns off when you shift out of reverse (R).

Driving Aids

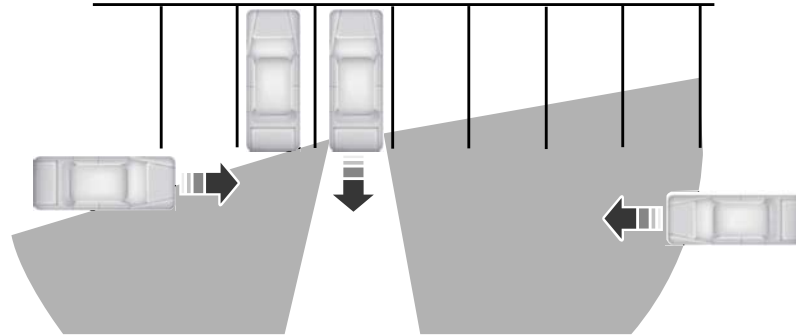

The sensor on the left-hand side is only partially obstructed and zone coverage on the right-hand side is maximized.

Driving Aids

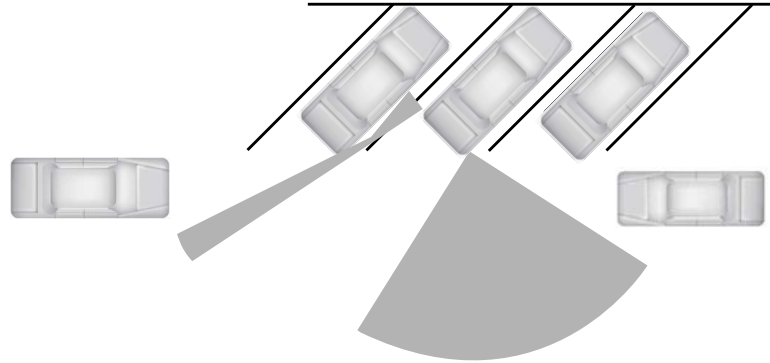

Zone coverage also decreases when parking at narrow angles. The sensor on the left-hand side is mostly obstructed and zone coverage on that side is severely reduced.

Cross Traffic Alert System Sensors

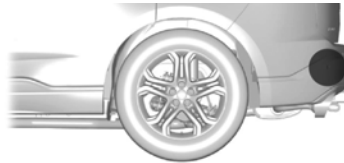

The sensors are behind the rear bumper on both sides of your vehicle.

Note: Keep the sensors free from snow, ice and large accumulations of dirt.

Note: Do not cover the sensors with bumper stickers, repair compound or other objects.

Note: Blocked sensors could affect system performance.

Driving Aids

If the sensors are blocked, a message may appear in the information display when you shift into reverse (R).

Cross Traffic Alert System Limitations

The system may not correctly operate when any of the following occur:

- The sensors are blocked.
- Adjacently parked vehicles or objects are obstructing the sensors.

- Vehicles approach at speeds less than 6 km/h (4 mph) or greater than 60 km/h (37 mph).
- The vehicle speed is greater than 12 km/h (7 mph).
- You reverse out of an angled parking space.

Switching Cross Traffic Alert On or Off

To switch cross traffic alert on or off, use the information display controls on the steering wheel to select the following:

Menu Item	Action
Driver assist.	Press the menu button.
Cross traffic alert	Press the OK button.

Note: If you temporarily switch the system off, it turns on the next time you switch the ignition on.

Note: The system may not correctly operate when towing a trailer. For vehicles with a trailer tow module and tow bar approved by us, the system turns off when you attach a trailer. For vehicles with an aftermarket trailer tow module or tow bar, we recommend that you switch the system off when you attach a trailer.

To permanently switch the system off, contact an authorized dealer.

Cross Traffic Alert Indicator



When the system detects an approaching vehicle a tone sounds, an indicator illuminates in the relevant exterior mirror and arrows appear in the information display to show which side the approaching vehicle is coming from.

Note: If arrows do not display, a message appears in the information display.

If the system malfunctions, an indicator illuminates in the instrument cluster and a message appears in the information display. Have your vehicle checked as soon as possible.

Note: In exceptional conditions, the system could alert you or apply the brakes, even when there is nothing in the detection zone, for example a vehicle passing further away from your vehicle.

Driving Aids

Cross Traffic Alert Information Messages

Message	Action
Cross traffic alert	Displays instead of indication arrows when the system detects a vehicle. Check for approaching traffic.
Cross traffic not available Sensor blocked See manual	Displays if the cross traffic alert system sensors are blocked. Clean the sensors. If the message continues to appear, have your vehicle checked as soon as possible.
Cross traffic malfunction	The system has malfunctioned. Have your vehicle checked as soon as possible.
Cross traffic alert deactivated Trailer attached	Displays if you attach a trailer to your vehicle.
Cross traffic alert Applying brakes	Displays if the system applies the brakes. Check for approaching traffic.

TRAFFIC SIGN RECOGNITION

Principle of Operation

 **WARNING:** You are responsible for controlling your vehicle at all times. The system is designed to be an aid and does not relieve you of your responsibility to drive with due care and attention. Failure to follow this instruction could result in the loss of control of your vehicle, personal injury or death.



WARNING: The system may not operate properly if the sensor is blocked. Keep the windshield free from obstruction.

The system is designed to detect traffic signs to inform you of the current speed limit and overtaking regulations. Detected traffic signs appear in the information display. The sensor is behind the interior mirror.

Note: Do not carry out windshield repairs in the immediate area surrounding the sensor.

Note: Traffic sign data provided by the navigation system contains information integrated to the data carrier release.

The system detects recognizable traffic signs, for example:

- Speed limit signs.
- No overtaking signs.
- Speed limit cancellation signs.
- No overtaking cancellation signs.

Note: The system may not detect all traffic signs and may incorrectly read signs.

Driving Aids

Note: In cold and severe weather conditions the system may not function. Rain, snow, spray and large contrasts in lighting can all prevent the sensor from correctly functioning.

Note: If your vehicle has a suspension kit not approved by us, the system may not correctly function.

Note: Always fit Ford original parts when replacing headlamp bulbs. Other bulbs may reduce system performance.

The system turns on when you switch the ignition on and you cannot switch the system off.

Switching Speed Warning On and Off

1. Using the information display controls on the steering wheel, select **Driver assist..**
2. Select **Traffic sign recognition.**
3. Select **Activate Traff. Sign Recog..**
4. Select **Activate speed warning.**
5. Switch **Overspeed chime** on or off.

Setting the Speed Warning

You can set the system speed warning to alert you when the vehicle speed exceeds the speed limit recognized by the system by a certain speed tolerance.

1. Using the information display controls on the steering wheel, select **Driver assist..**
2. Select **Traffic sign recognition.**
3. Select **Activate Traff. Sign Recog..**
4. Select **Activate speed warning.**
5. Select **Speed warning.**
6. Select a setting and press the **OK** button.

Traffic Sign Recognition System Display



The system can display two traffic signs in parallel.

You can view the status at any time using the information display.

The system displays recognizable traffic signs in four stages as follows:

1. All new traffic signs appear brighter than the others in the display.
2. After a predetermined time they display normally.
3. After a predetermined distance they are greyed out.
4. After another predetermined distance they are deleted.

If the system detects a supplementary traffic sign, it displays below the respective traffic sign. For example, when passing a reduced speed limit in wet road conditions sign.

Note: If your vehicle has a navigation system, stored traffic sign data may influence the indicated speed limit value.

Driving Aids

Traffic Sign Recognition System Messages

Message	Action
Traffic sign recognition Reduced performance See manual	The traffic sign data provided by the navigation system is unavailable due to weak or no signal. Wait for a short period of time for the signal to improve. If the message continues to appear, have your vehicle checked as soon as possible.

SPEED SIGN RECOGNITION

Principle of Operation



WARNING: You are responsible for controlling your vehicle at all times. The system is designed to be an aid and does not relieve you of your responsibility to drive with due care and attention. Failure to follow this instruction could result in the loss of control of your vehicle, personal injury or death.



WARNING: The system may not operate properly if the sensor is blocked. Keep the windshield free from obstruction.

The system is designed to detect speed limit signs to inform you of the current speed limit. Detected speed signs appear in the information display. The sensor is behind the interior mirror.

Note: Do not carry out windshield repairs in the immediate area surrounding the sensor.

Note: Speed sign data provided by the navigation system contains information integrated to the data carrier release.

Note: The system may not detect all speed signs and may incorrectly read signs.

Note: In cold and severe weather conditions the system may not function. Rain, snow, spray and large contrasts in lighting can all prevent the sensor from correctly functioning.

Note: If your vehicle has a suspension kit not approved by us, the system may not correctly function.

Note: Always fit Ford original parts when replacing headlamp bulbs. Other bulbs may reduce system performance.

The system turns on when you switch the ignition on and you cannot switch the system off.

Using Speed Sign Recognition

Switching Speed Warning On and Off

1. Using the information display controls on the steering wheel, select **Driver assist..**
2. Select **Traffic sign recognition.**
3. Select **Activate Traff. Sign Recog..**
4. Select **Activate speed warning.**
5. Switch **Overspeed chime** on or off.

Driving Aids

Setting the System Speed Warning

You can set the system speed warning to alert you when the vehicle speed exceeds the speed limit recognized by the system by a certain speed tolerance.

1. Using the information display controls on the steering wheel, select **Driver assist..**
2. Select **Traffic sign recognition.**
3. Select **Activate Traff. Sign Recog..**
4. Select **Activate speed warning.**
5. Select **Speed warning.**
6. Select a setting and press the **OK** button.

Note: *The system remembers the last setting when you start your vehicle.*

Speed Sign Recognition System Display



When the system detects a speed limit sign, the speed limit appears in the information display.

Note: *If your vehicle has a navigation system, stored speed sign data could influence the indicated speed limit value.*

Speed Sign Recognition System Messages

Message	Action
Traffic sign recognition Reduced performance See manual	The traffic sign data provided by the navigation system is unavailable due to weak or no signal. Wait for a short period of time for the signal to improve. If the message continues to appear, have your vehicle checked as soon as possible.

Driving Aids

ECO

Eco Mode

How Does Eco Mode Work

The system is designed to monitor certain driving characteristics to help you drive more efficiently. See **Driving Economically** (page 282).

Note: The efficiency levels do not result in a defined fuel consumption figure. See **Fuel Consumption** (page 189).

Note: The system only indicates the efficiency level for the current trip. The system resets each time you switch the ignition on.

Instantaneous Efficiency Level

The display ring increases as the instantaneous efficiency level increases and illuminates when it reaches maximum efficiency. The level continuously updates to indicate the efficiency level for the current trip.

Viewing the Instantaneous Efficiency Level

1. Using the information display controls on the steering wheel, select **MyView**.
2. Select **Eco coach**.

Trip Summary

The calculated trip summary is shown as four colored bars. The bars travel from left to right as the calculated efficiency levels increase. The bars indicate the average efficiency level for acceleration, deceleration, speed and gear shifting during the total distance traveled by your vehicle for the current trip.

Note: Vehicles with an automatic transmission do not have a bar for gear shifting.

Viewing the Trip Summary

1. Using the information display controls on the steering wheel, select **MyView**.
2. Select **Eco coach**.

PRE-COLLISION ASSIST

 **WARNING:** You are responsible for controlling your vehicle at all times. The system is designed to be an aid and does not relieve you of your responsibility to drive with due care and attention. Failure to follow this instruction could result in the loss of control of your vehicle, personal injury or death.

 **WARNING:** The system does not operate during hard acceleration or steering. Failure to take care may lead to a crash or personal injury.

 **WARNING:** The system may fail or operate with reduced function during cold and severe weather conditions. Snow, ice, rain, spray and fog can adversely affect the system. Keep the front camera and radar free of snow and ice. Failure to take care may result in the loss of control of your vehicle, serious personal injury or death.

 **WARNING:** The system may not operate properly if your vehicle has a non-Ford windshield. Do not carry out windshield repairs in the area around the sensor.

 **WARNING:** In situations where the vehicle camera has limited detection capability, this may reduce system performance. These situations include but are not limited to direct or low sunlight, vehicles at night without tail lights, unconventional vehicle types, pedestrians

Driving Aids

with complex backgrounds, running pedestrians, partly obscured pedestrians, or pedestrians that the system cannot distinguish from a group. Failure to take care may result in the loss of control of your vehicle, serious personal injury or death.



WARNING: The Pre-Collision Assist system with brake support cannot help prevent all collisions. Do not rely on this system to replace your judgment and the need to maintain correct distance and speed.

The pre-collision assist system is active when your vehicle reaches a speed greater than approximately 5 km/h (3 mph). Pedestrian detection is active at speeds up to 80 km/h (50 mph).

Note: *The system is not designed to detect animals.*

Note: *The system is not designed to detect vehicles or cyclists that are traveling in a different direction.*



E156130

If your vehicle is rapidly approaching another stationary vehicle, a vehicle or cyclist traveling in the same direction as yours, or a pedestrian within your driving path, the system is designed to provide three levels of functionality.

Level of Functionality	Description
Alert	When activated, a warning lamp flashes and an audible warning sounds.
Brake support	The system is designed to help reduce the impact speed by preparing the brakes for rapid braking. The system does not automatically apply the brakes. If you press the brake pedal, the system could apply additional braking up to maximum braking force, even if you lightly press the brake pedal.
Active braking - vehicles without adaptive cruise control	The system is designed to apply the brakes if it detects a crash is imminent. This may help reduce impact or avoid the crash. The system is active at speeds up to 130 km/h (80 mph).
Active braking - vehicles with adaptive cruise control	The system is designed to apply the brakes if it detects a crash is imminent. This may help reduce impact or avoid the crash.

Driving Aids

To switch active braking on or off, use the information display controls on the steering wheel to select the following:

Menu Item	Action
Driver assist.	Press the menu button.
Pre-collision Assist	Press the OK button.
Active braking	Press the OK button.

Distance Alert (if Equipped)

A warning lamp illuminates if the distance to the vehicle ahead is small.

Note: *The warning lamp does not illuminate if cruise control or adaptive cruise control is active.*

Distance Alert Sensitivity Settings

To adjust the distance alert sensitivity settings, use the information display controls on the steering wheel to select the following:

Menu Item	Action
Driver assist.	Press the menu button.
Pre-collision Assist	Press the OK button.
Alert sensitivity	Press the OK button. Press the toggle button upward or downward to choose your required setting. Press the OK button.

Driving Aids

Distance Indication (If Equipped)

A graphical indication displays the time gap

to vehicles ahead of you traveling in the same direction.

Note: *The graphic does not display if you switch on cruise control or adaptive cruise control.*

Vehicle Speed	System Sensitivity	Distance Indicator Color	Distance Gap	Time Gap
100 km/h (62 mph)	Normal.	Gray.	Greater than 25 m (82.0 ft)	Greater than 0.9 seconds.
		Yellow.	17–25 m (55.8–82.0 ft).	0.6–0.9 seconds.
		Red.	Less than 17 m (55.8 ft).	Less than 0.6 seconds.

Switching Distance Indication On or Off

To switch distance indication on or off, use the information display controls on the steering wheel to select the following:

Menu Item	Action
Driver assist.	Press the menu button.
Pre-collision Assist	Press the OK button.
Distance indication	Press the OK button.

Driving Aids

Pre-Collision Assist System Sensors

Vehicles without Adaptive Cruise Control



E243054

The camera is mounted behind the interior mirror.

Note: Keep the sensors free from snow, ice and large accumulations of dirt.

Note: Do not clean the sensors with sharp objects.

Note: If your vehicle sustains damage leaving the sensors misaligned, this may cause inaccurate measurements or false alerts.

Blocked sensors could affect system accuracy. A message may appear in the information display.

Vehicles with Adaptive Cruise Control



E243054

The camera is mounted behind the interior mirror.



E244279

The radar sensor is behind the front grille below the license plate.

Note: Keep the sensors free from snow, ice and large accumulations of dirt.

Note: Do not clean the sensors with sharp objects.

Note: If your vehicle sustains damage leaving the sensors misaligned, this may cause inaccurate measurements or false alerts.

Blocked sensors could affect system accuracy. A message may appear in the information display.

Pre-Collision Assist Warning Lamp



It illuminates if your vehicle rapidly approaches another vehicle, to warn you of the risk of a crash with the vehicle in front of you.

It could illuminate red if the distance to the vehicle ahead is small.

It illuminates when the system is not available.

Driving Aids

Pre-Collision Assist Information Messages

Message	Action
Pre-collision assist not available	The system has malfunctioned. Have your vehicle checked as soon as possible.
Pre-collision assist not available Sensor blocked	The sensors are dirty. Clean the sensors. If the message continues to appear, have your vehicle checked as soon as possible.

The following table lists possible causes and actions for when a blocked sensor message may display.

Cause	Action
The surface of the radar in the radiator grille is dirty or obstructed.	Clean the radiator grille in front of the radar or remove any obstruction.
The surface of the radar is clean but the message remains in the display.	Wait for a short period of time. It may take several minutes for the system to detect that there is no obstruction.
Heavy rain, spray, snow, or fog is interfering with the radar signals.	The system is temporarily disabled. The system should reactivate after a short period of time when the weather conditions improve.
The radar is misaligned.	Have your vehicle checked as soon as possible.
The windshield in front of the camera is dirty or obstructed.	Clean the outside of the windshield in front of the camera.
The windshield in front of the camera is clean but the message remains in the display.	Wait for a short period of time. It may take several minutes for the camera to detect that there is no obstruction.
Excessive heat around the camera.	Wait for a short period of time. The message should clear when the temperature around the camera decreases.

Drive Mode Control

WHAT IS DRIVE MODE CONTROL

Your vehicle has various drive modes that you can select for different driving conditions. Depending on the drive mode that you select, the system adjusts various vehicle settings, for example steering, gear shifting, handling and powertrain response.

SELECTING A DRIVE MODE - EXCLUDING: ST

The button is on the center console.



Repeatedly press the button to scroll through the available drive modes.

DRIVE MODES

Eco



Vehicle settings suited for economical driving.

Normal



Vehicle settings suited for balanced driving.

Note: This is the default mode each time you switch the ignition on.

Slippery - Excluding: ST



Vehicle settings suited for driving on slippery roads.

Sport - Excluding: ST



Vehicle settings suited for sportier driving.

Note: Auto-start-stop switches off when you select this mode.

Track - ST



Vehicle settings suited for track driving.

Note: Auto-start-stop switches off when you select this mode.

Note: Pre-collision assist is disabled when you select this mode.

Note: Lane keeping system is disabled when you select this mode.

Note: Track mode is not intended for use on public roads.

Note: Stability control is switched to reduced mode when you select this mode.

Trail - Excluding: ST



Vehicle settings suited for driving on unpaved roads.

Note: Auto-start-stop is disabled when you select this mode.

Drive Mode Control

DRIVE MODE CONTROL – TROUBLESHOOTING

Drive Mode Control – Information Messages

Message	Description
Drive mode not available	The system is not available. If it is still not available the next time you switch the ignition on, the system has malfunctioned. Have your vehicle checked as soon as possible.

Efficient Drive Mode

WHAT IS EFFICIENT DRIVE MODE

Efficient drive mode is a predictive coach that uses the vehicle navigation data. It provides predictive route information to help you drive more efficiently by indicating when you can release the accelerator pedal.

SWITCHING EFFICIENT DRIVE MODE ON AND OFF

1. Using the information display controls on the steering wheel, select **Driver assist**.
2. Select **Eco coach**.
3. Switch **Eco advice** on or off.

DISPLAYING THE EFFICIENT DRIVE MODE

1. Using the information display controls on the steering wheel, select **Driver assist**.

TRIP SUMMARY

How Does Trip Summary Work

The calculated trip summary is shown as five colored bars. The bars travel from left to right as the calculated efficiency levels increase. The bars indicate the average efficiency level for your driving behavior, acceleration, deceleration, speed, gear shifting and compliance score during the total distance traveled by your vehicle for the current trip.

Note: *The compliance score assesses how well you follow the efficient drive mode indicator.*

Note: *Vehicles with an automatic transmission do not have a bar for gear shifting.*

Viewing the Trip Summary

1. Using the information display controls on the steering wheel, select **MyView**.
2. Select **Eco coach**.
3. Switch the engine off.
4. Press the **OK** button.

EFFICIENT DRIVE MODE INDICATORS



It illuminates grey when the system advises you to decelerate.

It changes color when you start to decelerate.

The additional display ring next to the efficient drive mode indicator can provide information about speed limit, intersection, freeway ramp, roundabout, stop sign, slope, curve or crosswalk.

Local Hazard Information

WHAT IS LOCAL HAZARD INFORMATION

The system is designed to provide near real-time information about the road in front of you.

LOCAL HAZARD INFORMATION PRECAUTIONS



WARNING: You are responsible for controlling your vehicle at all times. The system is designed to be an aid and does not relieve you of your responsibility to drive with due care and attention. Failure to follow this instruction could result in the loss of control of your vehicle, personal injury or death.

ENABLING LOCAL HAZARD INFORMATION

Note: Make sure that the modem is enabled. See **Enabling and Disabling the Modem** (page 399).

1. Select **Settings**.

2. Select **FordPass Connect**.
3. Select **Connectivity settings**.
4. Switch **Vehicle connectivity** on.
5. Switch **Location** on.
6. Switch **Vehicle data & Remote ctrl** on.
7. Switch **Live Traffic** on.
8. Switch **Local hazard information** on.

CHECKING LOCAL HAZARD INFORMATION STATUS

1. Using the information display controls on the steering wheel, select **Settings**.
2. Select **Information**.
3. Select **Local hazard information**.

Load Carrying

GENERAL INFORMATION

WARNING: Make sure that you properly secure objects in the luggage compartment. Failure to follow this instruction could result in personal injury in the event of a sudden stop or crash.

WARNING: Do not place objects on the luggage cover. Failure to follow this instruction could result in personal injury or death in the event of a sudden stop or crash.

WARNING: The appropriate loading capacity of your vehicle can be limited either by volume capacity (how much space is available) or by payload capacity (how much weight the vehicle should carry). Once you have reached the maximum payload of your vehicle, do not add more cargo, even if there is space available. Overloading or improperly loading your vehicle can contribute to loss of vehicle control and vehicle rollover.

WARNING: Make sure that you fully close the liftgate to prevent exhaust fumes from entering your vehicle. If you are unable to fully close the liftgate, open the air vents or the windows to allow fresh air to enter your vehicle. Failure to follow this instruction could result in personal injury or death.

WARNING: Do not exceed the maximum front and rear axle loads for your vehicle.

Note: When loading long objects into your vehicle, for example pipes, timber or furniture be careful not to damage the interior trim.

REAR UNDER FLOOR STORAGE

Adjustable Load Floor

The adjustable load floor can be held open or placed in the upper or lower positions within the luggage compartment.

In the upper position, place it on top of the floor supports.

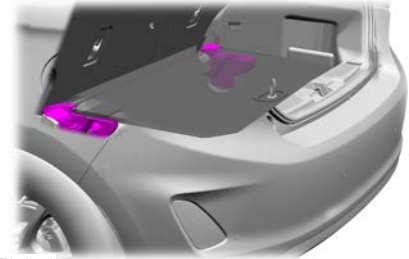

E270441

In the lower position, slide it into the lower slot in the floor supports.

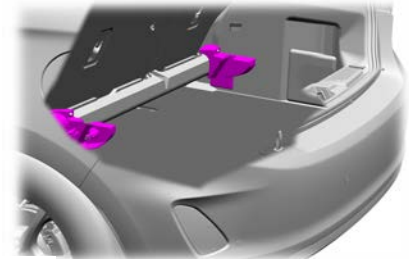

E270440

To hold the load floor open, raise and slide into the angled slots in the floor supports behind rear seats.

Load Carrying

LUGGAGE COVERS



WARNING: Do not load any objects on the shelf that may obstruct your vision or strike occupants of the vehicle in the case of a sudden stop or collision.

Removing the Cover

To remove the luggage cover:

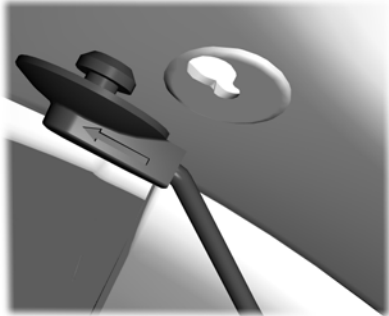

E266421

1. Gently push the retaining clip up and remove it.

2. Raise the luggage cover.
3. Pull the luggage cover backward.

ROOF RACKS AND LOAD CARRIERS - VEHICLES WITHOUT: PANORAMIC ROOF OPENING PANEL



WARNING: When loading the roof racks, we recommend you evenly distribute the load, as well as maintain a low center of gravity. Loaded vehicles, with higher centers of gravity, may handle differently than unloaded vehicles. Take extra precautions, such as slower speeds and increased stopping distance, when driving a heavily loaded vehicle.



WARNING: Read and follow the manufacturer's instructions when you are fitting a roof rack.

Maximum Roof Load

Variant	kg (lb)
All.	50 (110)

Make sure that you securely fasten the load. Check the tightness of the load before driving and at each fuel stop.

Never place loads directly on the roof panel.

Tow Bar Carriers

When using a tow bar attached carrier, consider the following:

- Do not exceed the maximum vertical load on the tow ball. This is the weight of the carrier plus the weight of the load. See **Towbar Dimensions** (page 376).
- Pay attention to the carrier manufacturer's specifications.
- If you are using a bike carrier, the maximum number of allowed bikes is three, with a maximum allowed weight of 60 kg (132 lb).
- Load the heaviest item closest to your vehicle.

Load Carrying

ROOF RACKS AND LOAD CARRIERS - VEHICLES WITH: PANORAMIC ROOF OPENING PANEL



WARNING: Your vehicle is not approved for roof racks. Never install a roof rack to your vehicle.

Towbar Carriers

When using a towbar attached carrier, consider the following:

- Do not exceed the maximum vertical weight on the towball. This is the weight of the carrier plus the weight of the load. See **Capacities and Specifications** (page 376).
- Pay attention to the carrier manufacturer's specifications.
- If you are using a bike carrier, the maximum number of allowed bikes is three, with a maximum allowed weight of 130 lb (60 kg).
- Load the heaviest item closest to your vehicle.

Towing

TOWING A TRAILER - EXCLUDING: ST

 **WARNING:** Do not exceed 100 km/h (60 mph). Failure to follow this instruction could result in the loss of control of your vehicle, personal injury or death.

 **WARNING:** The rear tire pressures must be increased by 0.2 bar (3 psi) above specification. Do not exceed the maximum pressure stated on the tire sidewall. This could cause serious personal injury.

 **WARNING:** Do not exceed the maximum gross vehicle weight stated on the vehicle identification plate. Failure to follow this instruction could result in personal injury.

 **WARNING:** Towing trailers beyond the maximum recommended gross trailer weight exceeds the limit of your vehicle and could result in engine damage, transmission damage, structural damage, loss of vehicle control, vehicle rollover and personal injury.

 **WARNING:** Do not exceed the maximum vertical load on the tow ball. Failure to follow this instruction could result in the loss of control of your vehicle, personal injury or death.

 **WARNING:** The anti-lock brake system does not control the trailer brakes.

When towing a trailer:

- Obey country specific regulations for towing a trailer.
- Do not exceed 100 km/h (60 mph) even if a country allows higher speeds under certain conditions.
- Place loads as low as possible and central to the axle of your trailer. If you are towing with an unloaded vehicle, you should place the load in your trailer toward the front, within the maximum vertical load, as this gives the best stability. See **Capacities and Specifications** (page 376).
- The trailer vertical weight on the tow ball is essential for the driving stability of your vehicle and trailer.

- The vertical weight on the tow ball should be at least 4% of the trailer weight and not exceed the maximum permissible weight. See **Capacities and Specifications** (page 376).
- Reduce speed immediately if the trailer shows any sign of swaying.
- Use a low gear when descending a steep slope.

Note: We recommend that you use a trailer safety cable. Read and follow the manufacturer's instructions when you use a trailer safety cable.

Note: The maximum permissible trailer vertical weight on the trailer identification plate is the trailer manufacturer's testing value. The vehicle maximum permissible trailer vertical weight may be lower.

The stability of your vehicle-to-trailer combination depends on the quality of the trailer.

Towing a trailer changes the handling characteristics of your vehicle and increases stopping distances. Adapt your speed and driving behaviour to the load of the trailer.

Towing

The gross train weight stated on the vehicle identification plate applies for road gradients up to 12% and altitudes up to 1,000 m (3,281 ft) when towing a trailer. In mountainous regions the engine performance decreases due to lower air density with increasing altitude. In high altitude regions above 1,000 m (3,281 ft), you should reduce the stipulated maximum permitted gross train weight by 10% for every additional 1,000 m (3,281 ft).

Note: *Not all vehicles are suitable or approved to have a tow bar fitted. Ask an authorized dealer for more information.*

TOWING A TRAILER - ST

WARNING: Your vehicle is not approved for trailer towing. Never tow a trailer with your vehicle.

TOW BALL

WARNING: Do not exceed the lowest rating capacity for your vehicle or trailer hitch. Overloading your vehicle or trailer hitch can impair your vehicle stability and handling. Failure to follow this instruction could result in the loss of control of your vehicle, personal injury or death.

WARNING: Do not cut, drill, weld or modify the trailer hitch. Modifying the trailer hitch could reduce the hitch rating.

Do not disassemble or repair the tow ball arm.

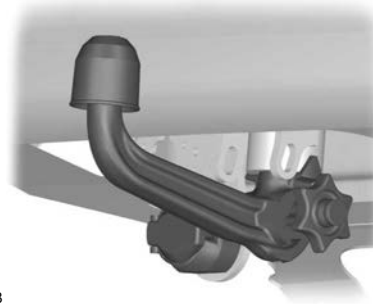

E71328

Detaching the Tow Ball Arm

WARNING: Always place the tow ball arm in a secure location in your vehicle so it does not become a projectile in a crash. Failure to follow this instruction could result in personal injury or death.

You must detach the tow ball arm when not in use. We recommend that you securely stow the tow ball arm in the luggage compartment.

Do not use any tools to detach the tow ball arm.

Never unlock or detach the tow ball arm with a trailer attached.

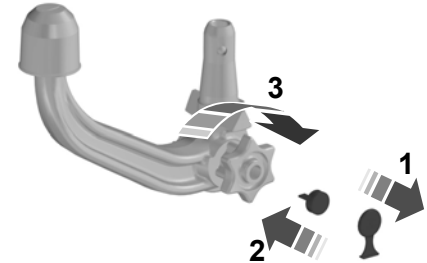

E71329

Towing

1. Remove the protective cap.
2. Insert the key and turn it counterclockwise to unlock the handwheel.
3. Hold the tow ball arm. Pull the handwheel outward and turn it fully clockwise until it clicks.

Note: *The red mark on the handwheel must align with the white dot on the tow ball arm.*

4. Release the handwheel.
5. Pull the tow ball arm downward to remove it.
6. Turn the trailer wiring connection socket upward through 90° until it engages in the end position.

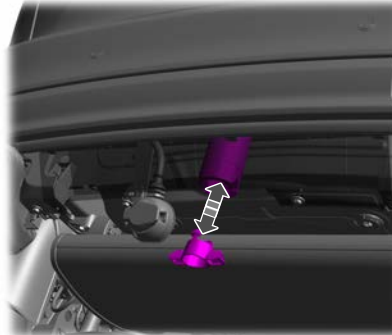

E265433

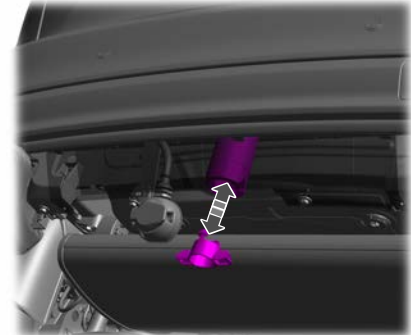

E265433

7. Insert the blanking plug.

Attaching the Tow Ball Arm

Do not use any tools to attach the tow ball arm.

Note: *You can only attach the tow ball arm if it is unlocked.*

Towing

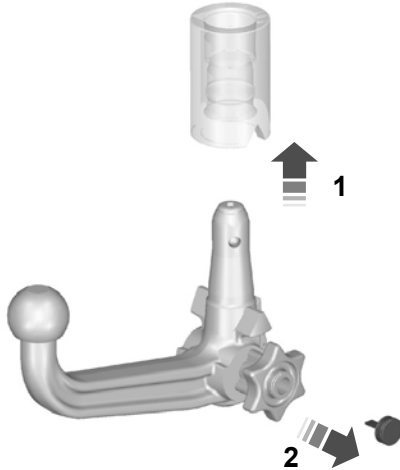

E71330

1. Remove the blanking plug and fully insert the tow ball arm until it engages.

Note: Do not place your hand near the handwheel.

Note: The green mark on the handwheel must align with the white dot on the tow ball arm.

2. Insert the key and turn it clockwise to lock the handwheel.
3. Fit the protective cap. Fully push it back over the lock.
4. Turn the trailer wiring connection socket downward through 90° until it engages in the end position.

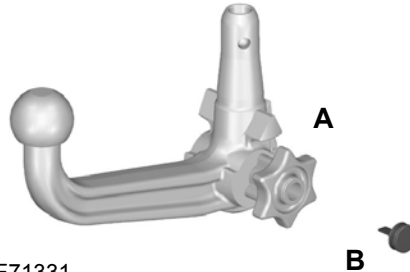

E71331

Check the following:

- The green mark on the handwheel is aligned with the white dot on the tow ball arm.
- The handwheel (A) is locked.
- You have removed the key (B).

Note: If any of these cannot be met, do not use the tow ball arm. Have your vehicle checked as soon as possible.

Quickly Detaching the Tow Ball Arm

Never unlock or detach the tow ball arm with a trailer attached.

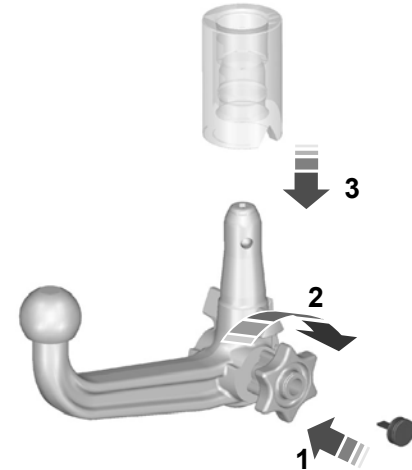

E71332

1. Remove the protective cap. Insert the key and turn it counterclockwise to unlock the handwheel.

Towing

2. Hold the tow ball arm. Pull the handwheel outward and turn it clockwise against the stop.
3. Pull the tow ball arm downward to remove it.
4. Release the handwheel.
5. Insert the blanking plug.

Quickly Attaching the Tow Ball Arm

When the tow ball arm is quickly detached, it can be quickly reattached.

1. Remove the blanking plug and fully insert the tow ball arm until it engages.

Note: Do not place your hand near the handwheel.

Note: The green mark on the handwheel must align with the white dot on the tow ball arm.

2. Insert the key and turn it clockwise to lock the handwheel.
3. Fit the protective cap. Fully push it back over the lock.

Tow Ball Arm Guidelines

- Replacement keys are available. We recommend that you record the key number on the lock cylinder.
- Keep the system clean. Periodically lubricate bearings, sliding surfaces and locking balls with resin-free grease or oil. Lubricate the lock with graphite.
- Remove the trailer wiring plug from the trailer wiring connection socket when not in use. Failure to do so may result in corrosion of the trailer wiring connection socket. Clean the trailer wiring connection socket regularly and make sure the socket cover is fully closed.
- If you use a high pressure water jet to clean your vehicle, disconnect the trailer wiring plug. Do not aim the water jet directly at the trailer wiring connection socket. We recommend that you detach the tow ball arm before washing your vehicle.

TOWING THE VEHICLE ON FOUR WHEELS - MANUAL TRANSMISSION



WARNING: You must switch the ignition on when your vehicle is being towed. Failure to follow this warning could seriously increase the risk of injury or death.



WARNING: The brake and steering assistance will not operate unless the engine is running. Press the brake pedal harder and be aware of increased stopping distances and heavier steering.



WARNING: If your vehicle has a steering wheel lock make sure the ignition is in the accessory or on position when being towed.



WARNING: Too much tension on a tow rope could cause damage to your vehicle or the vehicle that is towing.



WARNING: When towing your vehicle you must select neutral. Failure to follow this warning could damage the transmission and may lead to a crash or injury.

Towing

Drive off slowly and smoothly without jerking the vehicle you are towing.

You must only use the towing eye that was delivered with your vehicle. See **Towing Points** (page 287).

Tow ropes or rigid towing bars must be placed on the same side. For example; right hand rear towing point to right hand front towing point.

You must use a tow rope or rigid towing bar that is of the correct strength for the weight of the towing vehicle and the vehicle that is being towed.

The weight of the vehicle that is being towed must not exceed the weight of the towing vehicle.

Do not exceed 50 km/h (31 mph). See **Towing the Vehicle on Four Wheels** (page 279).

TOWING THE VEHICLE ON FOUR WHEELS - AUTOMATIC TRANSMISSION

 **WARNING:** You must switch the ignition on when your vehicle is being towed. Failure to follow this warning could seriously increase the risk of injury or death.

 **WARNING:** You must make sure the transmission selector lever is placed in position **N**. Failure to follow this warning could damage the transmission and may lead to a crash or injury.

 **WARNING:** The brake and steering assistance will not operate unless the engine is running. Press the brake pedal harder and allow for increased stopping distances and heavier steering. Failure to take care may lead to a crash or personal injury.

 **WARNING:** If your vehicle has a steering wheel lock, make sure the ignition is in the accessory or on position before you tow.

 **WARNING:** Too much tension on a tow rope could cause damage to your vehicle or the vehicle that is towing.

 **WARNING:** Do not tow your vehicle if the ambient temperature is below 0°C (32°F).

 **WARNING:** Do not tow your vehicle backward.

Emergency Towing

If your vehicle is disabled without access to wheel dollies, a car-hauling trailer, or a flatbed transport vehicle it can be flat-towed with all wheels on the ground. You may do this under the following conditions:

- Your vehicle is facing forward so that it is towed in a forward direction.
- The transmission selector lever is placed in position **N**. If the transmission gear shift lever cannot be moved to position **N**, it may need to be overridden. See **Automatic Transmission** (page 201).
- Maximum speed is 50 km/h (30 mph).
- Maximum distance is 80 km (50 mi).

Towing

Note: *If you need to exceed a speed of 50 km/h (30 mph) and a distance of 80 km (50 mi) while towing, you must lift the drive wheels clear of the ground.*

Note: *We recommend you do not tow with the drive wheels on the ground. However, if it is required to move the vehicle from a dangerous location, do not tow your vehicle faster than 50 km/h (30 mph) or farther than 80 km (50 mi).*



WARNING: In the event of a mechanical failure of the transmission, do not use individual axle carriers. All wheels must be lifted clear of the ground on a level platform.

Drive off slowly and smoothly without jerking the vehicle that is being towed.

You must only use the towing eye that was delivered with your vehicle. See **Towing Points** (page 287).

Tow ropes or rigid towing bars must be placed on the same side. For example; right hand rear towing point to right hand front towing point.

You must use a tow rope or rigid towing bar that is of the correct strength for the weight of the towing vehicle and the vehicle that is being towed.

Note: *Using a rigid towing bar is the safest way to tow a vehicle.*

The weight of the vehicle that is being towed must not exceed the weight of the towing vehicle.

Driving Hints

COLDWEATHERPRECAUTIONS

The functional operation of some components and systems can be affected at temperatures below approximately -25°C (-13°F).

BREAKING-IN

Tires

You need to break in new tires for approximately 480 km (300 mi). During this time, your vehicle may exhibit some unusual driving characteristics.

Brakes and Clutch

Avoid heavy use of the brakes and clutch if possible for the first 160 km (100 mi) in town and for the first 1,600 km (1,000 mi) on freeways.

ENGINE OVERSPEED

Note: *Always wait until the engine is properly warmed up before running high engine speeds.*

Your ST vehicle is equipped with an overspeed feature to increase its performance range. The standard maximum engine speed of 6300 RPM is indicated by a narrow redline on the tachometer face. The redline becomes thicker at the overspeed engine speed of 6600 RPM.

This feature allows one second of overspeed above 6300 RPM. Once the one second limit has been reached, the electronically controlled rev limit ramps down to 6300 RPM and holds there. Once engine speed has dropped below 6100 RPM, the overspeed timer is reset and one second of overspeed up to a maximum of 6600 RPM is enabled.

Do not operate the engine at high RPM and low load for sustained periods of time, as damage may occur.

DRIVING ECONOMICALLY

The following helps to improve fuel consumption:

- Drive smoothly, accelerate gently and anticipate the road ahead to avoid heavy braking.
- Regularly check your tire pressures and make sure that they are inflated to the correct pressure.

- Follow the recommended maintenance schedule and carry out the recommended checks.
- Plan your journey and check the traffic before you set off. It is more efficient to combine errands into a single trip whenever possible.
- Avoid idling the engine in cold weather or for extended periods. Start the engine only when you are ready to set off.
- Do not carry unnecessary weight in your vehicle as extra weight wastes fuel.
- Do not add unnecessary accessories to the exterior of your vehicle, for example running boards. If you use a roof rack, remember to fold it down or remove it when not in use.
- Do not shift into neutral when you are braking or when your vehicle is slowing down.
- Shut all windows when driving at high speeds.
- Switch off all electric systems when not in use, for example air conditioning. Make sure that you unplug any accessories from the auxiliary power points when not in use.

Driving Hints

DRIVING THROUGH SHALLOW WATER

WARNING: Do not attempt to cross a deep or flowing body of water. Failure to follow this instruction could result in the loss of control of your vehicle, personal injury or death.

Note: Driving through standing water can cause vehicle damage.

Note: Engine damage can occur if water enters the air filter.

Before driving through standing water, check the depth. Never drive through water that is higher than the bottom of the front rocker area of your vehicle.

When driving through standing water, drive very slowly and do not stop your vehicle. Your brake performance and traction could be limited. After driving through water and as soon as it is safe to do so:

- Lightly press the brake pedal to dry the brakes and to check that they work.
- Turn the steering wheel to check that the steering power assist works.

Check the function of the following:

- Horn
- Exterior lights



FLOOR MATS

WARNING: Use a floor mat designed to fit the footwell of your vehicle that does not obstruct the pedal area. Failure to follow this instruction could result in the loss of control of your vehicle, personal injury or death.

WARNING: Pedals that cannot move freely can cause loss of vehicle control and increase the risk of serious personal injury.

WARNING: Secure the floor mat to both retention devices so that it cannot slip out of position and interfere with the pedals. Failure to follow this instruction could result in the loss of control of your vehicle, personal injury or death.

WARNING: Do not place additional floor mats or any other covering on top of the original floor mats. This could result in the floor mat interfering with the operation of the pedals. Failure to follow this instruction could result in the loss of control of your vehicle, personal injury or death.

Driving Hints

 **WARNING:** Always make sure that objects cannot fall into the driver foot well while your vehicle is moving. Objects that are loose can become trapped under the pedals causing a loss of vehicle control.



To install the floor mats, position the floor mat eyelet over the retention post and press down to lock in position.

To remove the floor mat, reverse the installation procedure.

Note: Regularly check the floor mats to make sure they are secure.

Roadside Emergencies

HAZARD FLASHERS



The hazard flasher switch is on the instrument panel.

Use the hazard flashers if your vehicle is creating a safety hazard for other road users.

Switching the Hazard Flashers On or Off



Press the button to switch the hazard flashers on.

Press the button again to switch the hazard flashers off.

Note: All direction indicators flash.

Note: Prolonged use of the hazard flashers could cause the vehicle battery to run out of charge.

Note: Depending on applicable laws in the country your vehicle was built for, if you heavily brake, the hazard flashers could turn on.

Hazard Flasher Indicator



Flashes when you switch the hazard flashers on.

FIRST AID KIT

Space is provided in the luggage compartment.

WARNING TRIANGLE

Space is provided in the luggage compartment.

FUEL SHUTOFF

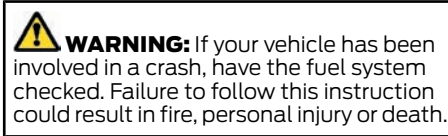

WARNING: If your vehicle has been involved in a crash, have the fuel system checked. Failure to follow this instruction could result in fire, personal injury or death.

In the event of a moderate to severe collision, this vehicle includes a fuel pump shutoff feature that stops the flow of fuel to the engine. Not every impact will cause a shutoff.

Should your vehicle shut off after a collision, you may restart your vehicle. For vehicles equipped with a key system:

1. Switch off the ignition.
2. Switch to start position.

3. Switch off the ignition.
4. Switch on the ignition to re-enable the fuel pump.

For vehicles equipped with a push button start system:

1. Press the **START/STOP** button to switch off the ignition.
2. Press the brake pedal and press the **START/STOP** button to switch on the ignition.
3. Remove your foot from the brake pedal and press the **START/STOP** button to switch off the ignition.
4. You can either attempt to start the engine by pressing the brake pedal and the **START/STOP** button, or switch on the ignition only by pressing the **START/STOP** button without pressing the brake pedal. Both ways re-enable the fuel system.

Note: When you try to restart your vehicle after a fuel shutoff, the vehicle makes sure that various systems are safe to restart. Once your vehicle determines that the systems are safe, then the vehicle will allow you to restart.

Note: In the event that your vehicle does not restart after your third attempt, contact an authorized dealer.

Roadside Emergencies

JUMP STARTING THE VEHICLE



WARNING: Do not use fuel lines, engine valve covers, windshield wiper arms, the intake manifold, or hood latch as ground points.



WARNING: Connect batteries with only the same nominal voltage.



WARNING: Use only adequately sized cables with insulated clamps.

Note: *Do not disconnect the battery from your vehicle's electrical system.*

Roadside Emergencies

To Connect the Booster Cables

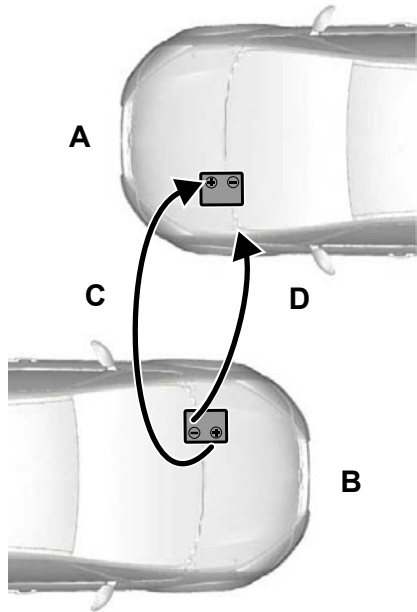

A Vehicle with low charge battery

- B Booster battery vehicle
- C Positive connection cable
- D Negative connection cable

1. Position the vehicles so that they do not touch one another.
2. Switch off the engine and any electrical equipment.
3. Connect the positive (+) terminal of vehicle B with the positive (+) terminal of vehicle A (cable C).

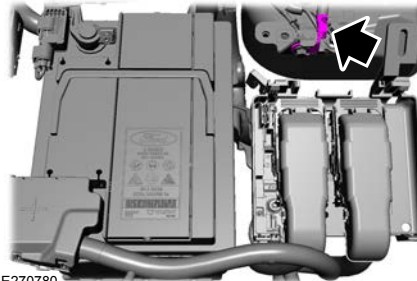

4. Connect the negative (-) terminal of vehicle B to the ground connection of vehicle A (cable D).

 **WARNING:** Do not connect the negative (-) cable to the negative (-) terminal of the discharged battery.

 **WARNING:** Make sure that the cables are clear of any moving parts and fuel delivery system parts.

To Start the Engine

1. Run the engine of vehicle B at a moderately high speed.
2. Start the engine of vehicle A.
3. Run both vehicles for a minimum of three minutes before disconnecting the cables. Do not switch on the headlamps when disconnecting the cables. The peak voltage could blow the bulbs.

Disconnect the cables in the reverse order.

TOWING POINTS

Front Towing Point

 **WARNING:** Make sure that the towing eye is fully tightened. Failure to follow this instruction could result in personal injury.

Roadside Emergencies

 **WARNING:** You must switch the ignition on when your vehicle is being towed.



E292787

1. Push the cover.
2. Carefully remove the cover.



E292904

3. Install the recovery hook.

Note: It has a left-hand thread. Turn it counterclockwise to install it.

The recovery hook is in the spare wheel well.

You must carry the recovery hook in your vehicle at all times.

Rear Towing Point

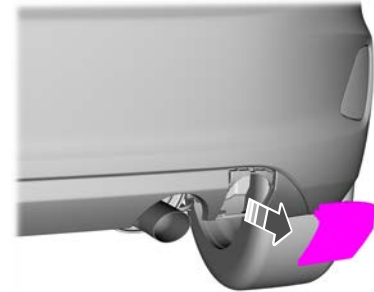

E250887

Remove the cover to install the recovery hook.

Note: If your vehicle has a tow bar, use this to tow other vehicles.

Crash and Breakdown Information

POST-CRASH ALERT SYSTEM

What Is the Post-Crash Alert System

The system helps draw attention to your vehicle in the event of a serious impact.

How Does the Post-Crash Alert System Work

The system is designed to turn the hazard flashers on and to intermittently sound the horn in the event of a serious impact that deploys an airbag or the seatbelt pretensioners.

Post-Crash Alert System Limitations

Depending on applicable laws in the country your vehicle was built for, the horn does not sound in the event of a serious impact.

Switching the Post-Crash Alert System Off

Press the hazard flasher switch or the unlock button on the remote control to switch the system off.

Note: *The alert turns off when the vehicle battery runs out of charge.*

POST IMPACT BRAKING

How Does Post Impact Braking Work

In the event of a moderate to severe crash, the braking system reduces the vehicle's speed in order to prevent or reduce the impact of a potential secondary crash.

Post Impact Braking Limitations

Post impact braking does not activate if any of the following occur:

- The anti-lock braking system is damaged during the collision.
- Electronic stability control is disabled.
- Vehicle speed is below 10 km/h (5 mph).

Overriding Post Impact Braking

You can override post impact braking by pressing the brake or accelerator pedal.

Post Impact Braking Indicators



It flashes when a post impact braking event is occurring.

Fuses

FUSE BOX LOCATIONS

Engine Compartment Fuse Box

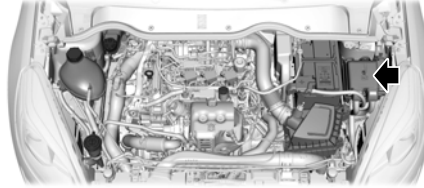

E250016

Passenger Compartment Fuse Box

The fuse box is behind the glove compartment.

Fuses

FUSE SPECIFICATION CHART

Engine Compartment Fuse Box

Fuses

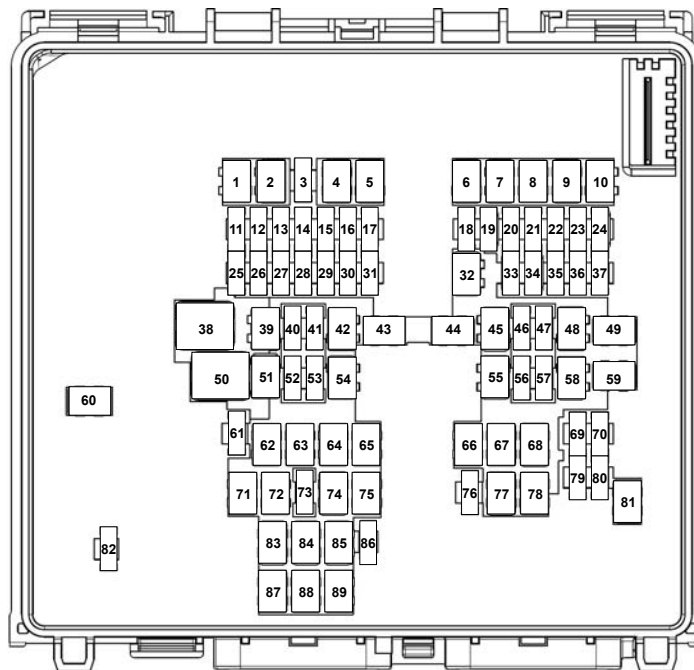

Fuses

Item	Fuse Rating	Protected Component
1	-	Not used.
2	60 A	Intake air heater.
3	10 A	Windshield heated washer jets.
4	40 A	Left-hand heated windshield element.
5	-	Not used.
6	30 A	Starter motor.
7	40 A	Blower motor.
8	-	Not used.
9	40 A	Dual-clutch transmission - Diesel.
10	-	Not used.
11	20 A	Steering column lock.
12	10 A	Air conditioning clutch.
13	-	Not used.
14	-	Not used.
15	-	Not used.
16	5 A	Belt integrated starter generator - MHEV.
17	5 A	Powertrain control module.

Fuses

Item	Fuse Rating	Protected Component
18	10 A	Heated steering wheel.
19	5 A	Electronic power assist steering.
20	7.5 A	Transmission control module.
21	-	Not used.
22	-	Not used.
23	-	Not used.
24	-	Not used.
25	10 A	Coolant pump. Exhaust valve.
26	15 A	Evaporative emission canister purge valve. Camshaft position sensor. Fuel injection control pressure sensor. Turbocharger variable vane control solenoid. Exhaust gas recirculation cooler bypass valve. Wastegate control valve solenoid. Heated oxygen sensor.
27	20 A	Powertrain control module.
28	15 A	Active grille shutter. Oil pump. Air conditioning compressor. Wastegate control valve solenoid. Water-in-fuel sensor.

Fuses

Item	Fuse Rating	Protected Component
29	15 A	Ignition coil. Noise suppression capacitor.
30	10 A	Air conditioning pressure relief valve.
31	10 A	Battery energy control module - MHEV.
32	30 A	Body control module.
33	10 A	Blind spot information system. Cruise control module. Front parking aid camera. Rear parking aid camera. Parking assist control module.
34	10 A	Transmission fluid pump.
35	10 A	Headlamps.
36	5 A	Anti-lock brake system.
37	15 A	Charge air cooling fan.
38	40 A	Blower motor.
39	-	Not used.
40	10 A	Battery energy control module - MHEV.
41	20 A	Heated seats.
42	-	Not used.

Fuses

Item	Fuse Rating	Protected Component
43	40 A	Trailer tow module.
44	40 A	Right-hand heated windshield element.
45	30 A	Left-hand rear door module.
46	5 A	Headlamp leveling.
47	15 A	Audio unit amplifier.
48	20 A	Moonroof.
49	60 A	Anti-lock brake pump.
50	60 A	High-speed cooling fan.
51	20 A	Transmission fluid pump.
52	10 A	Data link connector.
53	-	Not used.
54	30 A	Right-hand rear door module.
55	30 A	Anti-lock brake valve.
56	5 A	Brake on-off switch.
57	15 A	Audio unit amplifier.
58	-	Not used.
59	40 A	Body control module.

Fuses

Item	Fuse Rating	Protected Component
60	-	Not used.
61	-	Not used.
62	-	Not used.
63	-	Not used.
64	-	Not used.
65	-	Not used.
66	-	Not used.
67	-	Not used.
68	20 A	Fuel pump.
69	20 A	Fuel heater - diesel.
70	-	Not used.
71	-	Not used.
72	-	Not used.
73	5 A	Rain sensor.
74	30 A	Windshield wiper motor.
75	-	Not used.
76	-	Not used.

Fuses

Item	Fuse Rating	Protected Component
77	25 A	Heated rear window.
78	-	Not used.
79	20 A	Horn.
80	-	Not used.
81	25 A	Fuel heater - diesel.
82	15 A	Rear window washer pump.
83	20 A	Cigar lighter. Front auxiliary power points.
84	-	Not used.
85	40 A	Low-speed cooling fan.
86	20 A	Rear window wiper.
87	-	Not used.
88	-	Not used.
89	-	Not used.

Fuses

Passenger Compartment Fuse Box

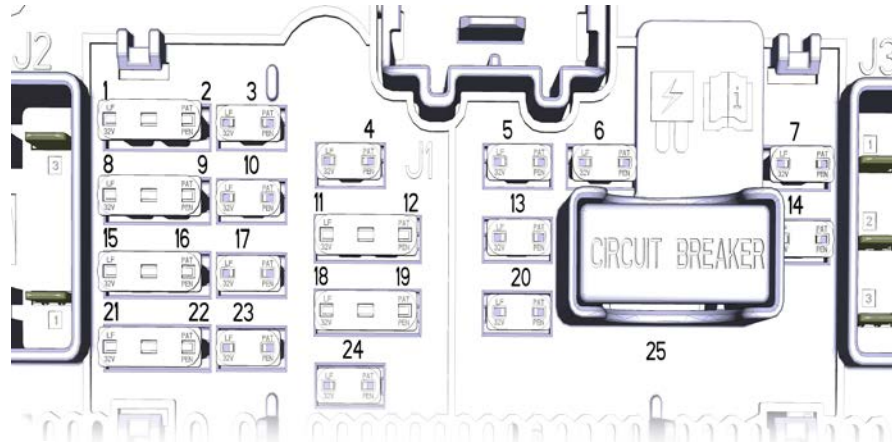

E249945

Item	Fuse Rating	Protected Component
1	5 A	Restraints control module.
2	5 A	In-vehicle temperature and humidity sensor.
3	10 A	Parking assist control module.
4	10 A	Ignition switch.

Fuses

Item	Fuse Rating	Protected Component
		Push button ignition switch.
5	20 A	Lock. Unlock.
6	10 A	Moonroof.
7	30 A	Right-hand mirror switch. Right-hand front power windows.
8	-	Not used.
9	5 A	Passenger airbag deactivation indicator. Auto-dimming interior mirror.
10	10 A	Data link connector.
11	5 A	Telematics modem.
12	5 A	Central security module.
13	15 A	Child safety locks. Fuel filler door.
14	30 A	Left-hand mirror switch. Left-hand front power windows.
15	15 A	Not used. Heated steering wheel. Headlamp control module.
16	-	Not used.

Fuses

Item	Fuse Rating	Protected Component
17	15 A	Voice control. Information and entertainment display. Compact disc player.
18	-	Not used.
19	7.5 A	Battery back-up sounder.
20	10 A	Anti-theft alarm horn.
21	7.5 A	Climate control.
22	7.5 A	Steering wheel module. Instrument cluster. Data link connector.
23	20 A	Audio unit.
24	-	Not used.
25	-	Not used.

Fuses

CHANGING A FUSE

General Information

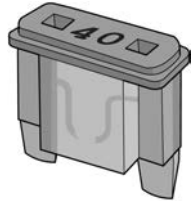

E217331

If electrical components in the vehicle are not working, a fuse may have blown. Blown fuses are identified by a broken wire within the fuse.

Engine Compartment Fuse Box

 **WARNING:** Always replace a fuse with one that has the specified amperage rating. Using a fuse with a higher amperage rating can cause severe wire damage and could start a fire.



E253688

1. Pull latch toward you and remove the top cover.

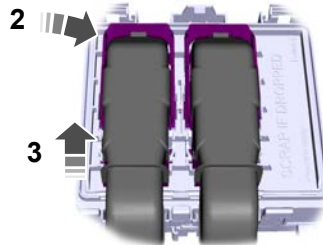

E253689

2. Lift connector lever upward.
3. Pull connector upward to remove it.

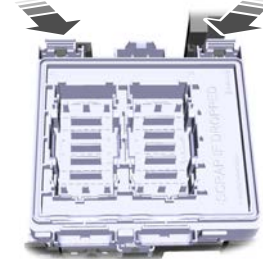

E253693

4. Pull both latches toward you and remove the fuse box.
5. Flip the fuse box over and open the lid.

Passenger Compartment Fuse Box

 **WARNING:** Always replace a fuse with one that has the specified amperage rating. Using a fuse with a higher amperage rating can cause severe wire damage and could start a fire.

1. Open the glove compartment and empty the contents.
2. Turn the retaining clips and remove them.

Fuses

- Press the sides inward and swivel the glove compartment downward.

Fuses Types

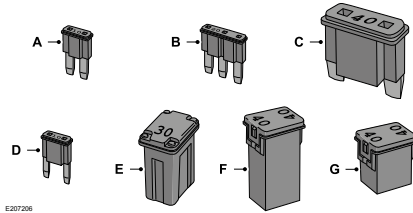

E207206

- A Micro 2.
- B Micro 3.
- C Maxi.
- D Mini.
- E M Case.
- F J Case.
- G J Case Low Profile.

Maintenance

GENERAL INFORMATION



WARNING: Do not work on a hot engine.



WARNING: Switch the ignition off and apply the parking brake.



WARNING: Do not touch the electronic ignition system parts after you have switched the ignition on or when the engine is running. The system operates at high voltage. Failure to adhere to this warning could result in serious personal injury or death.



WARNING: Keep your hands and clothing clear of the engine cooling fan.

Under certain conditions, the engine cooling fan may continue to run for several minutes after you switch your vehicle off. See **Engine Cooling Fan** (page 320).

Make sure that you fit filler caps securely after carrying out maintenance checks.

We recommend that you carry out the following checks.

Check Daily

- Exterior lamps.
- Interior lamps.
- Warning lamps and indicators.

Check When Refueling

- Washer fluid level. See **Washer Fluid Check** (page 324).
- Tire pressures. See **Tire Pressures** (page 353).
- Tire condition. See **Wheels and Tires** (page 343).

Check Monthly

- Engine oil level. See **Engine Oil Check** (page 317).
- Engine coolant level. See **Engine Coolant Check** (page 320).
- Brake fluid level. See **Brake Fluid Check** (page 321).
- Pipes, hoses and reservoirs for leaks.
- Air conditioning operation.
- Parking brake operation.
- Horn operation.
- Tightness of lug nuts. See **Lug Nuts** (page 371).

OPENING AND CLOSING THE HOOD

Opening the Hood

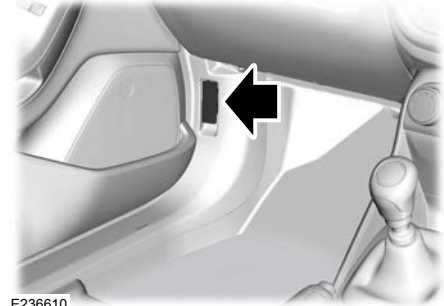

1. Pull the hood release lever.

Maintenance

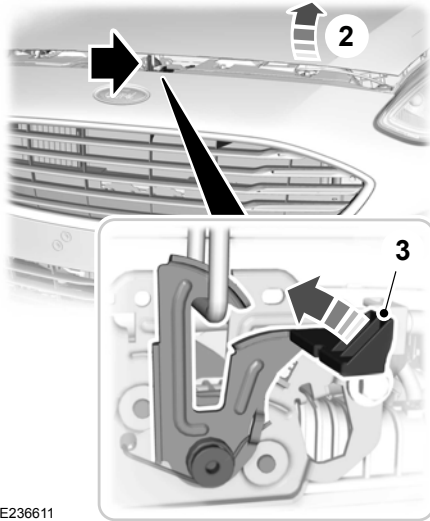

E236611

2. Slightly lift the hood.
3. Release the hood latch by pushing the secondary release lever to your left-hand side.
4. Open the hood.



E87786



5. Support the hood with the strut.

Closing the Hood

1. Remove the strut from the catch and secure it correctly in the clip.
2. Lower the hood and allow it to drop under its own weight for the last 20–30 cm (8–12 in).

Note: Make sure that the hood is correctly closed.

Maintenance

UNDER HOOD OVERVIEW - 1.0L ECOBOOST™, LHD

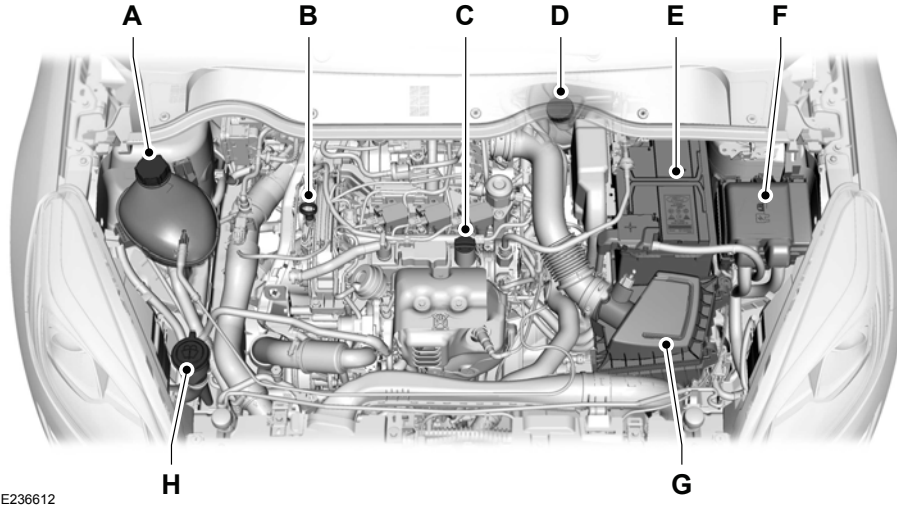

- A Engine coolant reservoir. See **Engine Coolant Check** (page 320).
- B Engine oil dipstick. See **Engine Oil Dipstick** (page 317).
- C Engine oil filler cap. See **Engine Oil Check** (page 317).
- D Brake fluid reservoir. See **Brake Fluid Check** (page 321).

Maintenance

- E Battery. See **Changing the 12V Battery** (page 322).
- F Engine compartment fuse box. See **Fuses** (page 290).
- G Air filter.
- H Windshield washer fluid reservoir. See **Washer Fluid Check** (page 324).

Maintenance

UNDER HOOD OVERVIEW - 1.0L ECOBOOST™, RHD

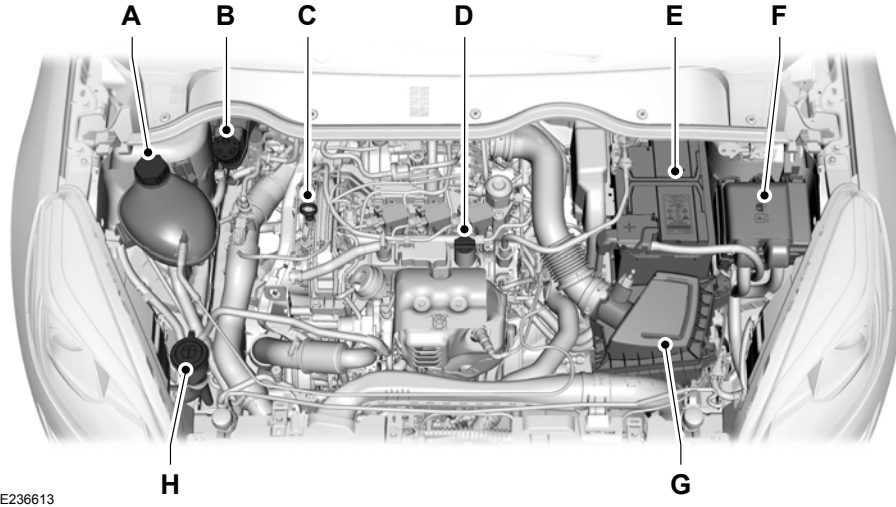

- A Engine coolant reservoir. See **Engine Coolant Check** (page 320).
- B Brake fluid reservoir. See **Brake Fluid Check** (page 321).
- C Engine oil dipstick. See **Engine Oil Dipstick** (page 317).
- D Engine oil filler cap. See **Engine Oil Check** (page 317).

Maintenance

- E Battery. See **Changing the 12V Battery** (page 322).
- F Engine compartment fuse box. See **Fuses** (page 290).
- G Air filter.
- H Windshield washer fluid reservoir. See **Washer Fluid Check** (page 324).

UNDER HOOD OVERVIEW - 1.1L DURATEC, LHD

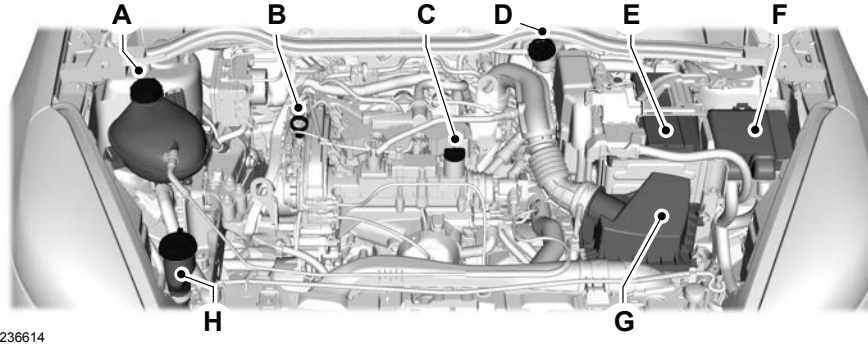

- A Engine coolant reservoir. See **Engine Coolant Check** (page 320).
- B Engine oil dipstick. See **Engine Oil Dipstick** (page 317).
- C Engine oil filler cap. See **Engine Oil Check** (page 317).

Maintenance

- D Brake fluid reservoir. See **Brake Fluid Check** (page 321).
- E Battery. See **Changing the 12V Battery** (page 322).
- F Engine compartment fuse box. See **Fuses** (page 290).
- G Air filter.
- H Windshield washer fluid reservoir. See **Washer Fluid Check** (page 324).

UNDER HOOD OVERVIEW - 1.1L DURATEC, RHD

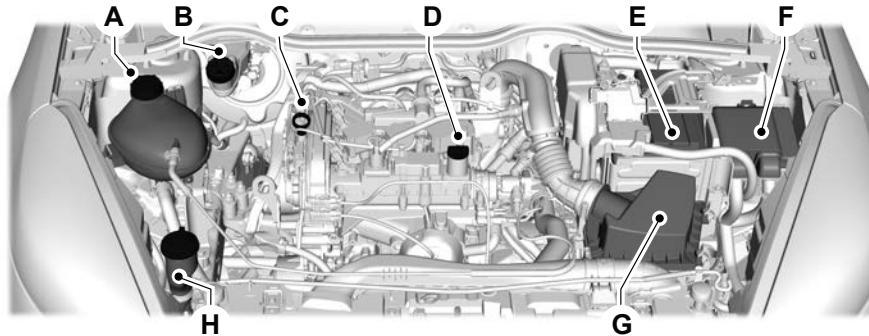

E236615

- A Engine coolant reservoir. See **Engine Coolant Check** (page 320).
- B Brake fluid reservoir. See **Brake Fluid Check** (page 321).

Maintenance

- C Engine oil dipstick. See **Engine Oil Dipstick** (page 317).
- D Engine oil filler cap. See **Engine Oil Check** (page 317).
- E Battery. See **Changing the 12V Battery** (page 322).
- F Engine compartment fuse box. See **Fuses** (page 290).
- G Air filter.
- H Windshield washer fluid reservoir. See **Washer Fluid Check** (page 324).

UNDER HOOD OVERVIEW - 1.5L DURATORQ-TDCI DIESEL, LHD

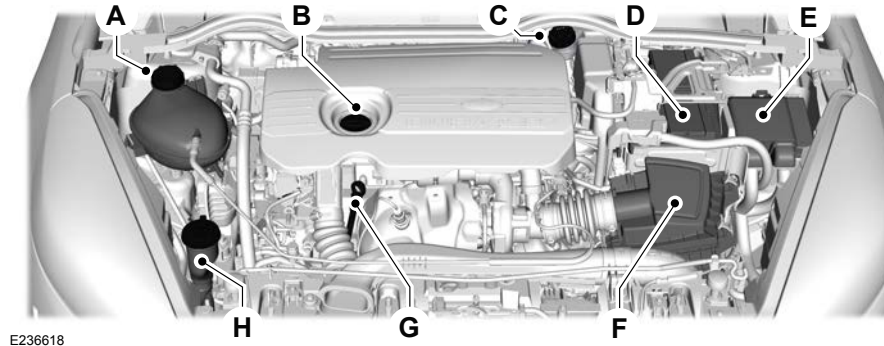

Maintenance

- A Engine coolant reservoir. See **Engine Coolant Check** (page 320).
- B Engine oil filler cap. See **Engine Oil Check** (page 317).
- C Brake fluid reservoir. See **Brake Fluid Check** (page 321).
- D Battery. See **Changing the 12V Battery** (page 322).
- E Engine compartment fuse box. See **Fuses** (page 290).
- F Air filter.
- G Engine oil dipstick. See **Engine Oil Dipstick** (page 317).
- H Windshield washer fluid reservoir. See **Washer Fluid Check** (page 324).

Maintenance

UNDER HOOD OVERVIEW - 1.5L DURATORQ-TDCI DIESEL, RHD

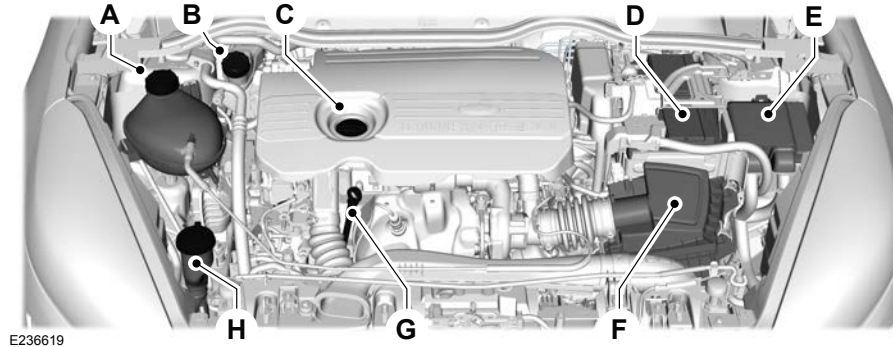

E236619

- A Engine coolant reservoir. See **Engine Coolant Check** (page 320).
- B Brake fluid reservoir. See **Brake Fluid Check** (page 321).
- C Engine oil filler cap. See **Engine Oil Check** (page 317).
- D Battery. See **Changing the 12V Battery** (page 322).
- E Engine compartment fuse box. See **Fuses** (page 290).
- F Air filter.
- G Engine oil dipstick. See **Engine Oil Dipstick** (page 317).
- H Windshield washer fluid reservoir. See **Washer Fluid Check** (page 324).

Maintenance

UNDER HOOD OVERVIEW - 1.5L ECOBOOST™, LHD

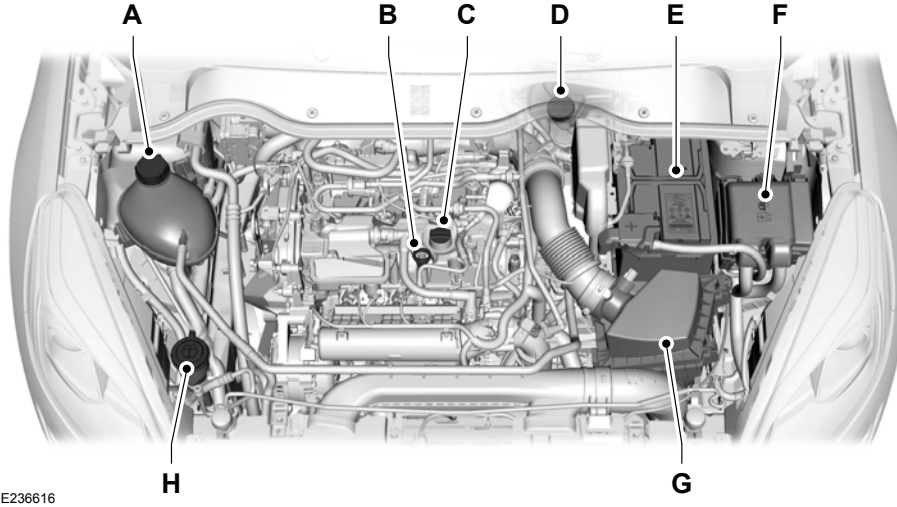

E236616

- A Engine coolant reservoir. See **Engine Coolant Check** (page 320).
- B Engine oil dipstick. See **Engine Oil Dipstick** (page 317).
- C Engine oil filler cap. See **Engine Oil Check** (page 317).
- D Brake fluid reservoir. See **Brake Fluid Check** (page 321).

Maintenance

- E Battery. See **Changing the 12V Battery** (page 322).
- F Engine compartment fuse box. See **Fuses** (page 290).
- G Air filter.
- H Windshield and rear window washer reservoir. See **Washer Fluid Check** (page 324).

Maintenance

UNDER HOOD OVERVIEW - 1.5L ECOBOOST™, RHD

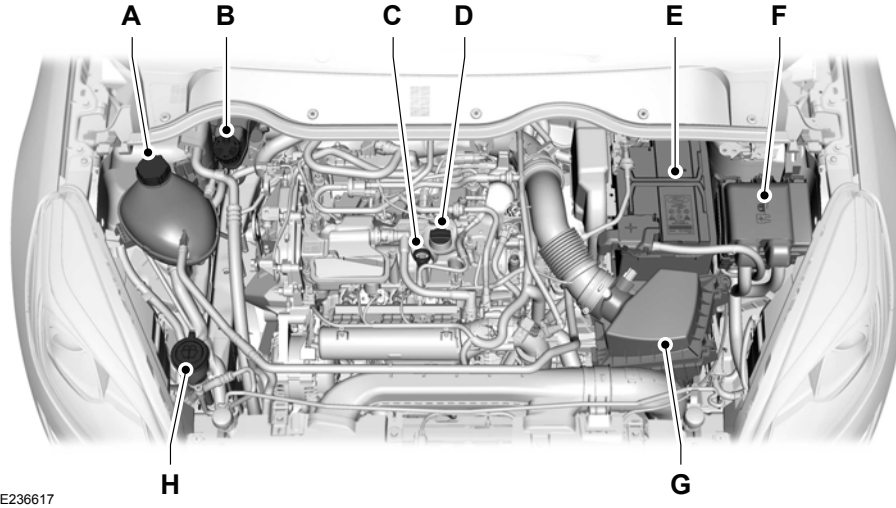

- A Engine coolant reservoir. See **Engine Coolant Check** (page 320).
- B Brake fluid reservoir. See **Brake Fluid Check** (page 321).
- C Engine oil dipstick. See **Engine Oil Dipstick** (page 317).
- D Engine oil filler cap. See **Engine Oil Check** (page 317).

Maintenance

- E Battery. See **Changing the 12V Battery** (page 322).
- F Engine compartment fuse box. See **Fuses** (page 290).
- G Air filter.
- H Windshield and rear window washer reservoir. See **Washer Fluid Check** (page 324).

ENGINE OIL DIPSTICK - 1.0L ECOBOOST™/1.1L DURATEC

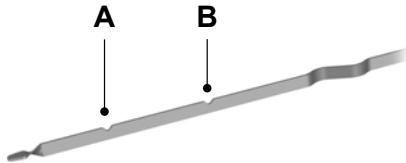

E141337

- A Minimum.
- B Maximum.

ENGINE OIL DIPSTICK - 1.5L DURATORQ-TDCI DIESEL

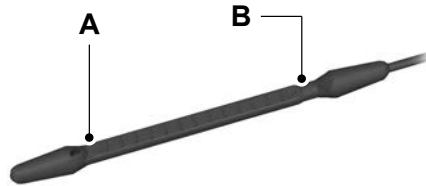

E140423

- A Minimum.
- B Maximum.

ENGINE OIL DIPSTICK - 1.5L ECOBOOST™

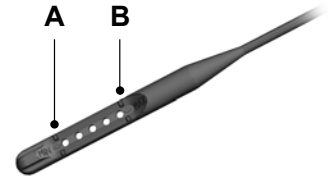

E264320

- A Minimum.
- B Maximum.

ENGINE OIL CHECK

1. Make sure that your vehicle is on level ground.

Maintenance

2. Check the oil level before starting the engine, or switch the engine off and wait 10 minutes for the oil to drain into the oil pan.
3. Remove the dipstick and wipe it with a clean, lint-free cloth.
4. Reinstall the dipstick and make sure it is fully seated.
5. Remove the dipstick again to check the oil level.

Note: *If the oil level is between the maximum and minimum marks, the oil level is acceptable. Do not add oil.*

6. If the oil level is at the minimum mark, immediately add oil.
7. Reinstall the dipstick. Make sure it is fully seated.

Note: *The oil consumption of new engines reaches its normal level after approximately 5,000 km (3,000 mi).*

Adding Engine Oil



WARNING: Do not add engine oil when the engine is hot. Failure to follow this instruction could result in personal injury.



WARNING: Do not remove the filler cap when the engine is running.

Do not use supplemental engine oil additives because they are unnecessary and could lead to engine damage that the vehicle warranty may not cover.

1. Clean the area surrounding the engine oil filler cap before you remove it.

2. Remove the engine oil filler cap.
3. Add engine oil that meets our specifications. See **Capacities and Specifications** (page 378).
4. Reinstall the engine oil filler cap. Turn it clockwise until you feel a strong resistance.

Note: *Do not add oil further than the maximum mark. Oil levels above the maximum mark may cause engine damage.*

Note: *Immediately soak up any oil spillage with an absorbent cloth.*

OIL CHANGE INDICATOR RESET

Only reset the system after changing the engine oil and oil filter.

Maintenance

To reset the oil change indicator, use the information display controls on the steering wheel to select the following:

Menu item	Action
Settings	Press the menu button.
Information	Press the OK button.
Oil life	Press the OK button.
Reset oil life	Press and hold the OK button until the system reset confirmation appears.

Maintenance

ENGINE COOLING FAN - GASOLINE

 **WARNING:** Keep your hands and clothing clear of the engine cooling fan.

Under certain conditions, the engine cooling fan may continue to run for several minutes after you switch your vehicle off.

ENGINE COOLING FAN - DIESEL

 **WARNING:** Keep your hands and clothing clear of the engine cooling fan.

Under certain conditions, the engine cooling fan may continue to run for several minutes after you switch your vehicle off. This could happen in low ambient temperatures and independent of the engine coolant temperature, for example short journeys or low coolant temperature. See **Diesel Particulate Filter** (page 193).

ENGINE COOLANT CHECK

 **WARNING:** Do not dispose of coolant in the household refuse or the public sewage system. Use an authorized waste disposal facility.

 **WARNING:** Do not put coolant in the windshield washer reservoir. If sprayed on the windshield, coolant could make it difficult to see through the windshield.



Make sure that the coolant level is between the **MIN** and **MAX** marks on the coolant reservoir at ambient temperature. If the coolant level is at or below the minimum mark, immediately add coolant.

The coolant concentration should be maintained within 48% to 50%, which equates to a freeze point between -34°C (-29°F) and -37°C (-35°F).

Note: *Coolant expands when it is hot. The level may extend beyond the **MAX** mark.*

Maintenance

Note: Do not use stop leak pellets, cooling system sealants, or non-specified additives as they can cause damage to the engine cooling or heating systems.

Adding Coolant

 **WARNING:** Do not remove the coolant reservoir cap when the engine is on or the cooling system is hot. Wait 10 minutes for the cooling system to cool down. Cover the coolant reservoir cap with a thick cloth to prevent the possibility of scalding and slowly remove the cap. Failure to follow this instruction could result in personal injury.

 **WARNING:** Do not allow the fluid to touch your skin or eyes. If this happens, rinse the affected areas immediately with plenty of water and contact your physician.

 **WARNING:** Undiluted coolant is flammable and may ignite if spilled on a hot exhaust.

We do not recommend the use of recycled engine coolant since a Ford-approved recycling process is not yet available.

Do not mix different colors or types of coolant in your vehicle.

Note: Add a 50/50 mixture of antifreeze and water or prediluted engine coolant that meets the correct specification.

Note: Use fluids which meet the specifications or requirements defined. Use of other fluids may lead to damage which is not covered by the vehicle Warranty. See **Capacities and Specifications** (page 378).

To top up the coolant level do the following:

1. Remove the coolant reservoir cap.
2. Add coolant to the **MAX** mark, do not overflow.
3. Replace the coolant reservoir cap. Turn it clockwise until you feel a strong resistance.

In case of emergency, you can add water without engine coolant in order to reach a vehicle service location.

Note: Prolonged use of an incorrect dilution of coolant can cause damage, for example corrosion, overheating or freezing.

BRAKE FLUID CHECK

 **WARNING:** Do not use any fluid other than the recommended brake fluid as this will reduce brake efficiency. Use of incorrect fluid could result in the loss of vehicle control, serious personal injury or death.

 **WARNING:** Only use brake fluid from a sealed container. Contamination with dirt, water, petroleum products or other materials may result in brake system damage or failure. Failure to adhere to this warning could result in the loss of vehicle control, serious personal injury or death.

 **WARNING:** Do not allow the fluid to touch your skin or eyes. If this happens, rinse the affected areas immediately with plenty of water and contact your physician.

 **WARNING:** A fluid level between the **MAX** and **MIN** lines is within the normal operating range and there is no need to add fluid. A fluid level not in the normal operating range could compromise the performance of the system. Have your vehicle checked immediately.

Maintenance



CLUTCH FLUID CHECK

The clutch and brake systems share the same fluid reservoir. See **Brake Fluid Check** (page 321).

CHANGING THE 12V BATTERY

WARNING: Batteries normally produce explosive gases which can cause personal injury. Therefore, do not allow flames, sparks or lighted substances to come near the battery. When working near the battery, always shield your face and protect your eyes. Always provide correct ventilation.

WARNING: When lifting a plastic-cased battery, excessive pressure on the end walls could cause acid to flow through the vent caps, resulting in personal injury and damage to the vehicle or battery. Lift the battery with a battery carrier or with your hands on opposite corners.

To avoid fluid contamination, the reservoir cap must remain in place and fully tight, unless you are adding fluid.

Only use fluid that meets Ford specifications. See **Capacities and Specifications** (page 378).

WARNING: Keep batteries out of reach of children. Batteries contain sulfuric acid. Avoid contact with skin, eyes or clothing. Shield your eyes when working near the battery to protect against possible splashing of acid solution. In case of acid contact with skin or eyes, flush immediately with water for a minimum of 15 minutes and get prompt medical attention. If acid is swallowed, call a physician immediately.

WARNING: Battery posts, terminals and related accessories contain lead and lead compounds. Wash hands after handling.

WARNING: For vehicles with Auto-Start-Stop the battery requirement is different. You must replace the battery with one of exactly the same specification.

The battery is in the engine compartment. See **Under Hood Overview** (page 306).

Your vehicle has a maintenance-free battery. It does not require additional water during service.

If the vehicle battery has a cover, make sure you correctly install it after cleaning or replacing the battery.

Maintenance

For longer, trouble-free operation, keep the top of the battery clean and dry and the battery cables tightly fastened to the battery terminals. If any corrosion is present on the battery or terminals, remove the cables from the terminals and clean with a wire brush. You can neutralize the acid with a solution of baking soda and water.

We recommend that you disconnect the negative battery cable terminal from the battery if you plan to store your vehicle for an extended period.

Note: *If you only disconnect the negative battery cable terminal, make sure it is isolated or placed away from the battery terminal to avoid unintended connection or arcing.*

To maintain correct operation of the battery management system, if you add any electrical devices to your vehicle, do not connect the ground connection directly to the negative battery terminal. A connection at the negative battery terminal can cause inaccurate measurements of the battery condition and potential incorrect system operation.

Note: *If you add electrical accessories or components to your vehicle this may adversely affect battery performance, durability and the performance of other electrical systems on your vehicle.*

If you replace the battery make sure it matches the electrical requirements of your vehicle.

If you disconnect or replace the battery and your vehicle has an automatic transmission, it must relearn its adaptive strategy. Because of this, the transmission may shift firmly when first driven. This is normal operation while the transmission fully updates its operation to optimum shift feel.

Remove and Reinstall the Battery

To disconnect or remove the battery, do the following:

1. Apply the parking brake and switch the ignition off.
2. Switch all electrical equipment off, for example lights and radio.
3. Wait a minimum of two minutes before disconnecting the battery.

Note: *The engine management system has a power hold function and remains powered for a period of time after you switch the ignition off. This is to allow diagnostic and adaptive tables to be stored. Disconnecting the battery without waiting can cause damage not covered by the vehicle Warranty.*

4. Disconnect the negative battery cable terminal.

5. Disconnect the positive battery cable terminal.
6. Remove the battery securing clamp.
7. Remove the battery.
8. To install, reverse the removal procedure.

Note: *Before reconnecting the battery, make sure the ignition remains switched off.*

Note: *Make sure the battery cable terminals are fully tightened.*

If you disconnect or replace the vehicle battery, you must reset the following features:

- Window bounce-back. See **Overriding Window Bounce-Back** (page 100).
- Clock Settings.
- Pre-set radio stations.

Battery Disposal



Make sure that you dispose of old batteries in an environmentally friendly way. Seek advice from your local authority about recycling old batteries.

Maintenance

WASHER FLUID CHECK

When adding fluid, use a mixture of washer fluid and water to help prevent freezing and improve the cleaning capability. For information on fluid dilution follow the manufacturer's instructions.

Note: The reservoir supplies the front and rear washer systems.

CHECKING THE WIPER BLADES



Run the tip of your fingers over the edge of the blade to check for roughness.

Clean the wiper blades with washer fluid or water applied with a soft sponge or cloth.

CHANGING THE FRONT WIPER BLADES

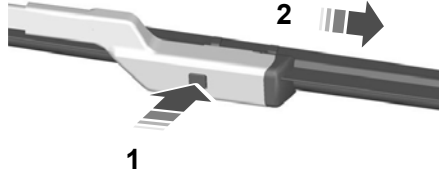

E72899

1. Lift the wiper arm and then press the wiper blade locking button.

Note: Do not hold the wiper blade to lift the wiper arm.

2. Remove the wiper blade.

Note: Make sure that the wiper arm does not spring back against the glass when the wiper blade is not attached.

3. To install, reverse the removal procedure.

Note: Make sure that the wiper blade locks into place.

CHANGING THE REAR WIPER BLADES

1. Lift the wiper arm.

Note: Do not hold the wiper blade to lift the wiper arm.

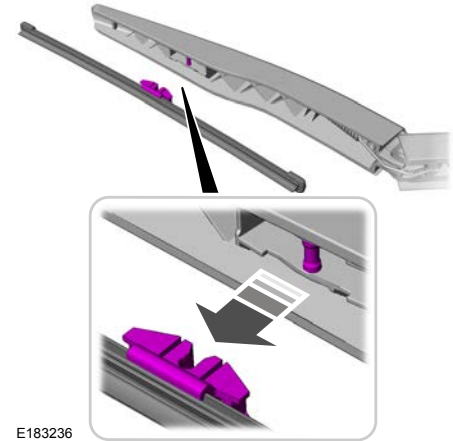

E183236

2. Disengage the wiper blade from the wiper arm.

Maintenance

Note: Make sure that the wiper arm does not spring back against the glass when the wiper blade is not attached.

3. To install, reverse the removal procedure.

Note: Make sure that the wiper blade locks into place.

REMOVING A HEADLAMP



WARNING: Switch the lamps and the ignition off. Failure to do so could result in serious personal injury.

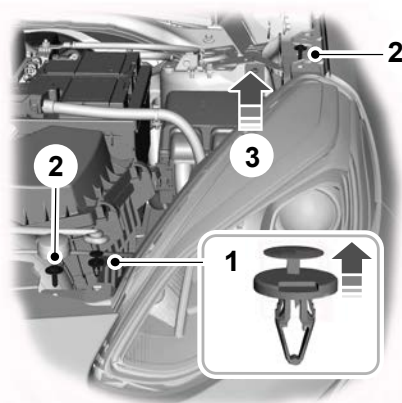

E236623

1. Use a suitable tool, for example a screwdriver, to carefully remove the trim clip.

Note: Raise the center pin and then remove the clip.

2. Remove the screws.



E249609

3. Place your hand below the headlamp housing and lift the headlamp at the center area to disengage the lower fixing clip.
4. Carefully lift the headlamp up at the front and rear to disengage it from the fixing points.

Note: Take care when removing the headlamp. There are rupture points adjacent to the securing screws that are designed to separate under impact.

5. Slightly rotate the rear of the headlamp toward the center of the vehicle so that it clears the front fender.
6. Move the headlamp slightly backwards to clear the radiator grille panel. Then lift the headlamp straight upward.
7. Disconnect the electrical connector.
8. Remove the headlamp.

Maintenance

9. To install, reverse the removal procedure.

REMOVING A REAR LAMP

Brake Lamp, Rear Lamp and Direction Indicator

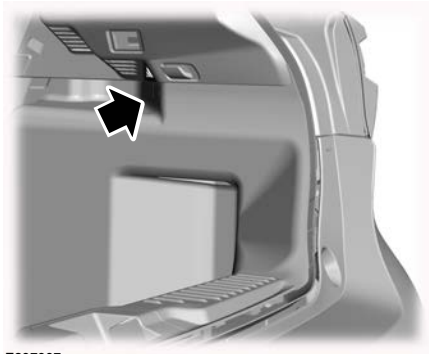

E237937

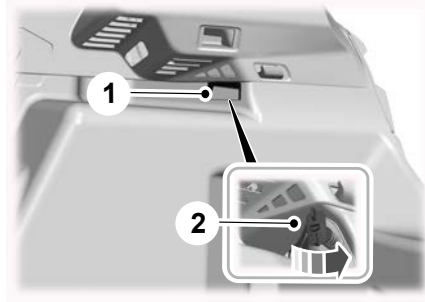

E237938

1. Carefully cut the trim to access the lamp release wing nut.
2. Turn the wing nut counterclockwise to release the lamp.

Note: *You cannot fully remove the wing nut.*

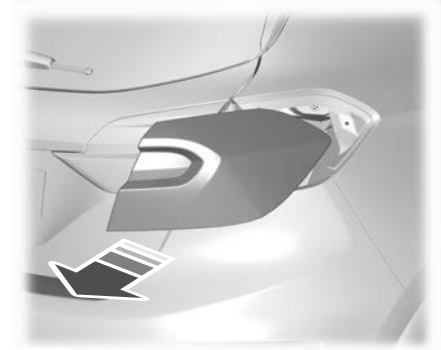

E236624

3. Remove the lamp.
4. Disconnect the electrical connector.
5. To install, reverse the removal procedure.

Maintenance

Reversing Lamp

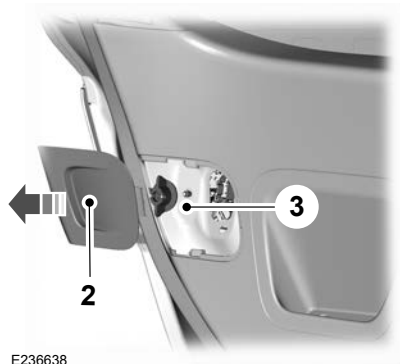

E236638

1. Open the liftgate.
2. Carefully remove the cover.
3. Turn the wing nut counterclockwise and remove it.

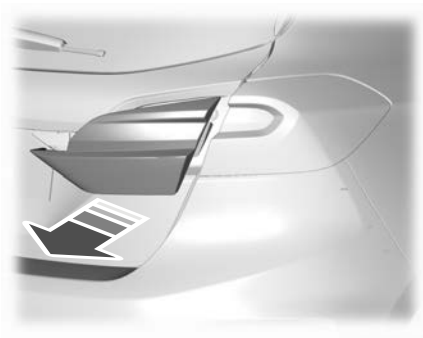

E238054

4. Remove the lamp.
5. Disconnect the electrical connector.
6. To install, reverse the removal procedure.

CHANGING A BULB

WARNING: Switch the lamps and the ignition off. Failure to do so could result in serious personal injury.

WARNING: Lamps and associated components become hot when in use. Let them cool down before you remove them.

Use the correct specification bulb. See **Bulb Specification Chart** (page 389).

Headlamp

You may have to remove the headlamp assembly prior to replacing a bulb. See **Removing a Headlamp** (page 325).

Reflector Headlamp

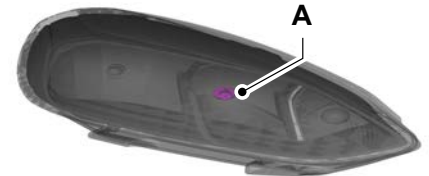

E249611

A Daytime running lamp.

Maintenance

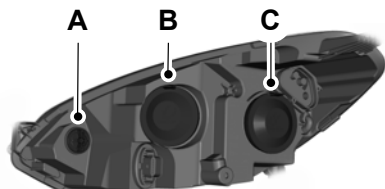

E236599

- A Front direction indicator.
- B High beam headlamp and daytime running lamp.
- C Low beam headlamp.

Low Beam Headlamp

1. Carefully remove the cover.

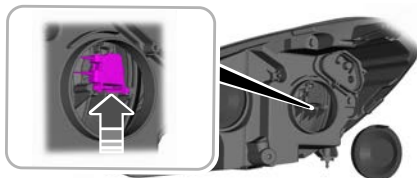

E249634

2. Press the clip up to release the bulb holder.

3. Remove the bulb holder by pulling it straight out.
4. Remove the bulb by pulling it straight out.
5. To install, reverse the removal procedure.

Note: Do not touch the bulb glass.

High Beam Headlamp and Daytime Running Lamp

1. Carefully remove the cover.
2. Disconnect the electrical connector.



E249637

3. Turn the bulb holder counterclockwise and remove it.

Note: You cannot separate the bulb from the bulb holder.

4. To install, reverse the removal procedure.

Note: Do not touch the bulb glass.

Projector Headlamp



E249612

- A Daytime running lamp.

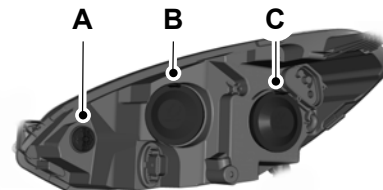

E236599

- A Front direction indicator.
- B High beam headlamp.
- C Low beam headlamp.

Low Beam Headlamp

1. Carefully remove the cover.

Maintenance

2. Disconnect the electrical connector.

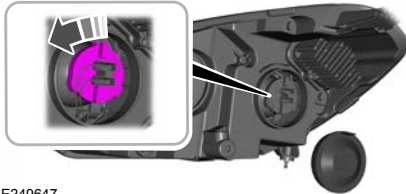

E249647

3. Turn the bulb holder counterclockwise and remove it.
4. Remove the bulb.
5. To install, reverse the removal procedure.

Note: Do not touch the bulb glass.

High Beam Headlamp

1. Carefully remove the cover.

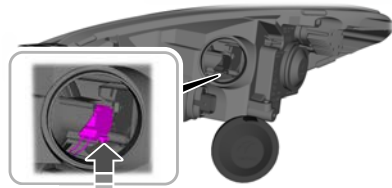

E249660

2. Press the clip up to release the bulb holder.
3. Remove the bulb holder by pulling it straight out.
4. Remove the bulb by pulling it straight out.
5. To install, reverse the removal procedure.

Note: Do not touch the bulb glass.

Daytime Running Lamp

These lamps have LEDs.

Note: We recommend that you have LEDs changed by an authorized dealer.

Front Direction Indicator

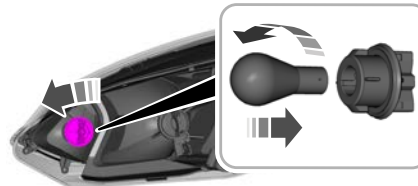

E236630

1. Turn the bulb holder counterclockwise and remove it.
2. Press the bulb in and turn the bulb counterclockwise to remove it.

3. To install, reverse the removal procedure.

LED Headlamp



E272995

A Daytime running lamp.

These lamps have LEDs.

Note: We recommend that you have LEDs changed by an authorized dealer.

Maintenance

Front Fog Lamp

All Vehicles - Excluding: ST, ST Line and Vignale

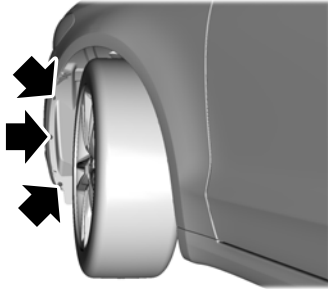

E159695

1. Use a suitable tool, for example a screwdriver, to carefully remove the wheel arch liner fasteners. Pull the wheel liner back toward the tire to gain access to the bulb.
2. Disconnect the electrical connector.



E236628

3. Turn the bulb holder counterclockwise and remove it.

Note: You cannot separate the bulb from the bulb holder.

4. To install, reverse the removal procedure.

Note: Do not touch the bulb glass.

ST, ST Line and Vignale

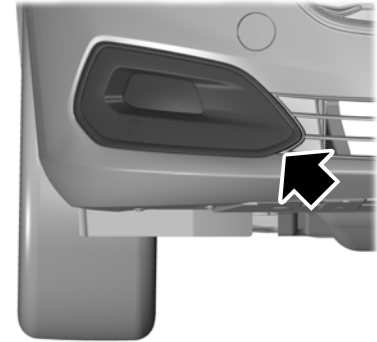

E273066

1. Use a suitable tool, for example a screwdriver, to carefully remove the housing cover.

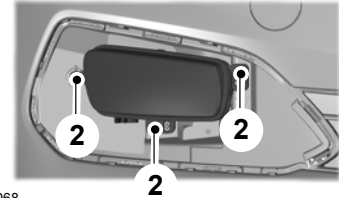

E273068

Maintenance

2. Remove the screws and the lamp.
3. Disconnect the electrical connector.
4. Turn the bulb holder counterclockwise and remove it.

Note: You cannot separate the bulb from the bulb holder.

5. To install, reverse the removal procedure.

Side Direction Indicator

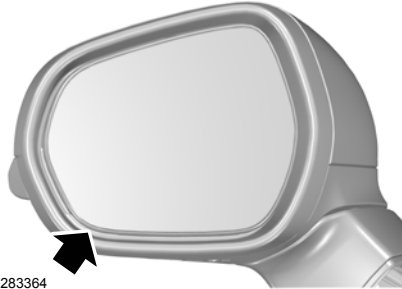

E283364

1. Use a suitable tool, for example a screwdriver, to carefully lever the mirror glass from the lower outer edge and remove it.
2. Unplug the connector from the rear side of the glass.

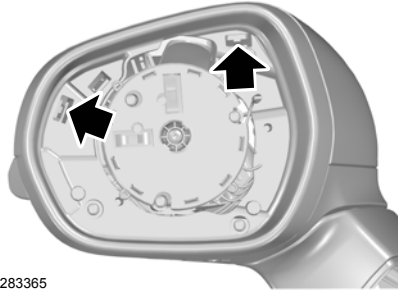

E283365

3. Use a suitable tool, for example a screwdriver, to carefully press the two housing cover clips and release them.

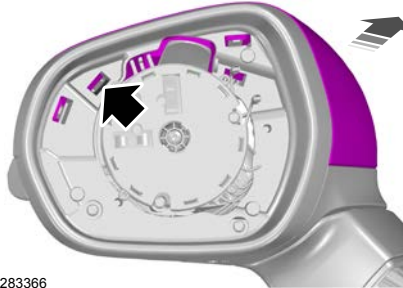

E283366

4. Use a suitable tool, for example a screwdriver, to push the housing cover through the access hole and remove it.

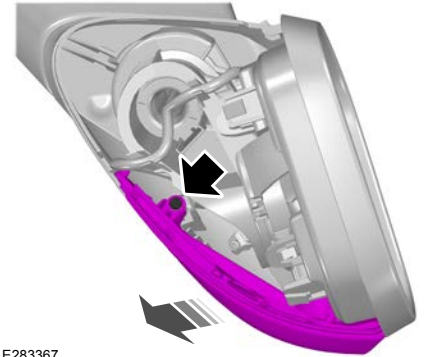

E283367

5. Use a T10 Torx screwdriver to remove the lamp body.

Maintenance

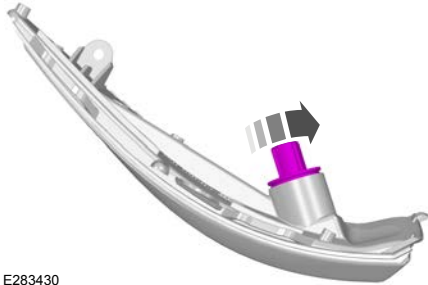

E283430

6. Turn the bulb holder clockwise and remove it.
7. Pull the bulb straight out.
8. To install, reverse the removal procedure.

Note: Make sure that both mirror housing cover clips lock into position.

Note: We recommend that you have bulbs changed by an authorized dealer.

Rear Lamp

Remove the rear lamp assembly prior to replacing any bulb. See **Removing a Rear Lamp** (page 326).

Rear Lamp and Stoplamp

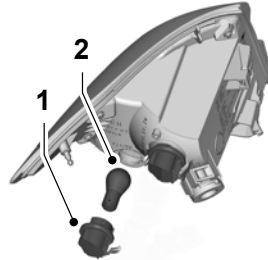

E236634

1. Turn the bulb holder counterclockwise and remove it.
2. Press the bulb in and turn the bulb counterclockwise to remove it.
3. To install, reverse the removal procedure.

Note: High series have LEDs.

Note: We recommend that you have LEDs changed by an authorized dealer.

Rear Direction Indicator

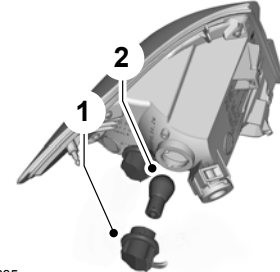

E236635

1. Turn the bulb holder counterclockwise and remove it.
2. Press the bulb in and turn the bulb counterclockwise to remove it.
3. To install, reverse the removal procedure.

Maintenance

Reversing Lamp



E236636

1. Turn the bulb holder counterclockwise and remove it.
2. Press the bulb in and turn the bulb counterclockwise to remove it.
3. To install, reverse the removal procedure.

License Plate Lamp

These lamps have LEDs.

Note: We recommend that you have LEDs changed by an authorized dealer.

High Mounted Stoplamp

These lamps have LEDs.

Note: We recommend that you have LEDs changed by an authorized dealer.

Rear Fog Lamp

Access the underside of your vehicle behind the rear wheel.

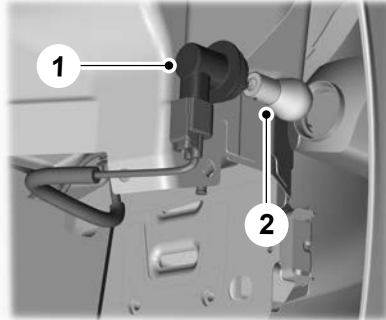

E236637

1. Turn the bulb holder counterclockwise and remove it.
2. Press the bulb in and turn the bulb counterclockwise to remove it.
3. To install, reverse the removal procedure.

Vehicle Care

CLEANING THE EXTERIOR

Cleaning the Exterior Precautions

Immediately remove fuel spillages, AdBlue residuals, bird droppings, insect deposits and road tar. These may cause damage to your vehicle's paintwork or trim over time.

Remove any exterior accessories, for example antennas, before entering a car wash.

Cleaning Headlamps and Rear Lamps

We recommend that you only use cold or lukewarm water containing car shampoo to clean the headlamps and the rear lamps.

Do not scrape the lamps.

Do not wipe lamps when they are dry.

Cleaning Windows and Wiper Blades

To clean the windshield and wiper blades:

- Clean the windshield with a non-abrasive glass cleaner.

Note: When cleaning the interior of the windshield, avoid getting any glass cleaner on the instrument panel or door panels. Wipe any glass cleaner off these surfaces immediately.

- Clean the wiper blades with washer fluid or water applied with a soft sponge or cloth.

Note: Do not use razor blades or other sharp objects to clean or remove decals from the inside of the heated rear window. This can cause damage not covered by the vehicle Warranty.

Cleaning Chrome, Aluminium or Stainless Steel

We recommend that you only use a car shampoo, a soft cloth and water on bumpers and other chrome, aluminium or stainless steel parts.

Note: For additional information and assistance, we recommend that you contact an authorized dealer.

Note: Rinse the area well after cleaning.

Note: Do not use abrasive materials, for example steel wool or plastic pads, as they can scratch these surfaces.

Note: Do not use chrome cleaner, metal cleaner or polish on wheels or wheel covers.

Cleaning Wheels

Only use a recommended wheel and tire cleaner to clean the wheels weekly. For additional information and assistance, we recommend that you contact an authorized dealer.

1. Use a sponge to remove heavy deposits of dirt and brake dust.
2. Rinse well after cleaning.

Note: Do not apply a cleaning chemical to warm or hot wheel rims and covers.

If you intend on parking your vehicle for an extended period after cleaning the wheels with a wheel cleaner, drive your vehicle for a few minutes before parking your vehicle. This reduces the risk of corrosion of the brake discs, brake pads and linings.

Do not clean the wheels when they are hot.

Note: Some car washes could damage wheel rims and covers.

Note: Using non-recommended cleaners, harsh cleaning products, chrome wheel cleaners or abrasive materials could damage wheel rims and covers.

Vehicle Care

Cleaning the Engine Compartment

Use a vacuum cleaner to remove debris from the screen area below windshield.

Note: *If you are not familiar with the parts around the engine do not wash the engine compartment. Avoid frequent engine washes.*

When washing the engine compartment:

- Never wash or rinse the engine while it is hot or running.
- Never wash or rinse any ignition coil, spark plug wire or spark plug well.
- Cover the battery, power distribution box, and air filter assembly to prevent water damage.

Note: *If your vehicle has an engine cover remove the cover before application of shampoo and degreaser.*

- Spray an approved engine shampoo and degreaser on all parts that require cleaning and rinse with water.

Cleaning Stripes or Graphics

It is recommended to wash your vehicle by hand however, pressure washing may be used under the following conditions:

- Use a spray with a 40° wide spray angle pattern.
- Keep the nozzle at a 305 mm (12 in) distance and 90° angle to your vehicle's surface.
- Do not use water pressure higher than 14,000 kPa (2,000 psi).
- Do not use water hotter than 82°C (179°F).

Note: *Holding the pressure washer nozzle at an angle to the vehicle's surface may damage graphics and cause the edges to peel away from the vehicle's surface.*

Cleaning Camera Lenses and Sensors

We recommend that you only use lukewarm or cold water and a soft cloth to clean the camera lens and sensors.

Note: *Do not pressure wash camera lens and sensors.*

Cleaning the Underbody

Flush the complete underside of your vehicle frequently. Keep body and door drain holes free from packed dirt.

Rear suspension components may require regular cleaning with a power washer or a thorough rinse with a strong stream of water if the vehicle is operated in dusty or muddy environments. Rear leaf springs or other suspension components may emit squeaking or popping noises while operating the vehicle if particles, such as dirt, rocks, or other debris, are present in the components.

CLEANING THE INTERIOR

Cleaning the Instrument Panel



WARNING: Do not use chemical solvents or strong detergents when cleaning the steering wheel or instrument panel to avoid contamination of the airbag system.

We recommend that you only clean the instrument panel and cluster lens with a damp soft cloth. Dry the area with a clean, soft cloth.

For additional information and assistance, we recommend that you contact an authorized dealer.

Vehicle Care

Note: Avoid cleaners or polishes that increase the gloss of the upper portion of the instrument panel. The dull finish in this area helps protect you from undesirable windshield reflection.

Cleaning Plastic

We recommend that you only use a mild soap and water solution on a soft cloth. Dry the area with a clean, soft cloth.

Cleaning Displays and Screens

We recommend that you only use a microfiber cloth in a circular motion to clean off the fingerprint or dust.

If dirt or fingerprints are still on the screen, apply a small amount of alcohol to the cloth and try to clean it again.

Note: Do not pour or spray alcohol onto the touchscreen.

Note: Do not use detergent or any type of solvent to clean the touchscreen.

Cleaning Leather and Vinyl

We recommend that you only clean the leather and vinyl surfaces in the following way:

1. Remove dust and loose dirt with a vacuum cleaner.
2. Wipe the surface with a soft, damp cloth and a mild soap and water solution. Dry the area with a clean, soft cloth.
3. Make sure the leather is dry, then apply a small amount of conditioner to a clean, dry cloth.
4. Rub the conditioner into the leather until it disappears. Allow the conditioner to dry, then repeat the process for the entire interior. If a film appears, wipe it off with a dry, clean cloth.
5. For additional information and assistance, we recommend that you contact an authorized dealer.

Cleaning Fabric Seats and Headliners



WARNING: On vehicles equipped with seat-mounted airbags, do not use chemical solvents or strong detergents. Such products could contaminate the side airbag system and affect performance of the side airbag in a crash.

We recommend that you only clean the fabric seats and headliners in the following way:

1. Remove dust and loose dirt with a vacuum cleaner.
2. Wipe the surface with a soft, damp cloth and a mild soap and water solution. Dry the area with a clean, soft cloth.
3. For additional information and assistance, we recommend that you contact an authorized dealer.

For heavy stains, spot clean the area. If a ring forms on the fabric, clean the entire area immediately, but do not oversaturate or the ring could set.

Vehicle Care

Cleaning Carpets and Floor Mats

We recommend that you only clean your carpets in the following way:

1. Remove dust and loose dirt with a vacuum cleaner.
2. Wipe the surface with a soft, damp cloth and a mild soap and water solution. Dry the area with a clean, soft cloth.
3. For additional information and assistance, we recommend that you contact an authorized dealer.

For heavy stains, spot clean the area. If a ring forms on the fabric, clean the entire area immediately, but do not oversaturate or the ring could set.

We recommend that you only clean your floor mats in the following way:

1. Remove dust and loose dirt with a vacuum cleaner.
2. Wash rubber floor mats using mild soap and lukewarm or cold water.
3. Completely dry the floor mat before placing them back in your vehicle.

Cleaning Seatbelts



WARNING: Do not use cleaning solvents, bleach or dye on the vehicle's seatbelts, as these actions may weaken the belt webbing.

1. Wipe the surface with a soft, damp cloth and a mild soap and water solution. Dry the area with a clean, soft cloth.

Cleaning Storage Compartments

1. Remove dust and loose dirt with a vacuum cleaner.
2. Wipe the surface with a soft, damp cloth and a mild soap and water solution. Dry the area with a clean, soft cloth.

Cleaning Moonroof Tracks

1. Remove debris from the tracks with a vacuum cleaner.
2. Wipe the bulb seal and mating painted roof metal surface with a soft, damp cloth and a mild soap and water solution.

REPAIRING MINOR PAINT DAMAGE

Authorized dealers have touch-up paint to match your vehicle's color. Your vehicle color code is printed on a sticker on the front, left-hand side door jamb. Take your color code to your authorized dealer to make sure you get the correct color.

Before repairing minor paint damage, use a cleaner to remove particles such as bird droppings, tree sap, insect deposits, tar spots, road salt and industrial fallout.

Read the instructions before using cleaning products.

WAXING YOUR VEHICLE

Wax the high-gloss painted surface of your prewashed vehicle once or twice a year.

We recommend that you only use an approved quality wax that does not contain abrasives. Follow the manufacturer's instructions to apply and remove the wax. For additional information and assistance, we recommend that you contact an authorized dealer.

When washing and waxing, park your vehicle in a shaded area out of direct sunlight.

Vehicle Care

Note: *Avoid waxing unpainted or low-gloss black colored parts, they discolor over time.*

Wheels and Tires

GENERAL INFORMATION

The recommended tire inflation pressures are on the tire information label on the driver side B-pillar.

Check and set the tire pressure at the ambient temperature in which you are intending to drive your vehicle and when the tires are cold. See **Tire Pressures** (page 353).

Note: Check your tire pressures regularly to optimize fuel economy.

Only use approved wheel and tire sizes. Using other sizes could damage your vehicle and could make the National Type Approval invalid.

Installation of any tires that are not the original equipment tire size can cause the speedometer to display incorrect vehicle speed.

TIRE SEALANT AND INFLATOR KIT - VEHICLES WITH: TEMPORARY MOBILITY KIT

WARNING: Do not use the inflator kit on run flat tires. This could cause loss of vehicle control.

WARNING: Depending on the type and extent of tire damage, some tires can only be partially sealed or not sealed at all. Loss of tire pressure can affect vehicle handling, leading to loss of vehicle control.

WARNING: Do not use the kit on a previously damaged tire, for example when it has been driven under inflated. This could cause loss of vehicle control, personal injury or death.

If your vehicle does not have a spare wheel it has a tire sealant and inflator kit. The kit is in the luggage compartment. Only use the kit supplied with your vehicle.

Note: The kit can only temporarily repair one tire puncture with a maximum puncture size of up to 6 mm (0.24 in).

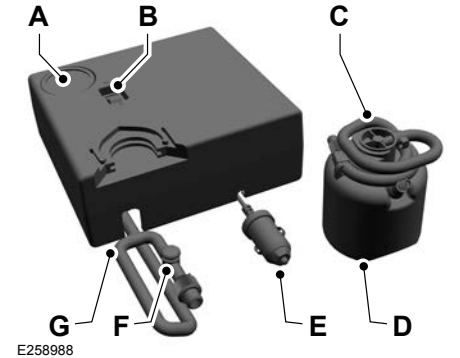

- A Pressure Gauge.
- B Power switch.
- C Sealant bottle tire inflation pipe.
- D Sealant bottle.
- E 12 volt DC power point connector.
- F Pressure relief valve.
- G Compressor tire inflation pipe.

Note: A maximum speed warning label is attached to the sealant bottle.

Wheels and Tires

Note: Do not use the sealant bottle after its expiry date. You can obtain a replacement sealant bottle from an authorized dealer.



If the low tire pressure warning lamp illuminates do the following:

1. Gradually reduce the vehicle speed and stop your vehicle as soon as it is safe to do so.
2. Apply the parking brake and switch the ignition off.
3. Check for a punctured tire.

Note: Do not remove objects, for example nails or screws from a punctured tire.

Using the Tire Sealant and Inflator Kit



WARNING: Check the sidewall of the tire prior to inflation. If there are any cracks, bumps or similar damage, do not attempt to inflate the tire. This could cause personal injury.



WARNING: Watch the sidewall of the tire when inflating. If any cracks, bumps or similar damage appears, switch the compressor off and let the air out by means of the pressure relief valve. Do not continue driving with this tire. This could cause loss of vehicle control.



WARNING: Do not stand directly beside the tire while the compressor is operating. This could cause personal injury if the tire bursts.



WARNING: Do not leave the kit unattended when it is in use. Failure to follow this instruction could result in personal injury or death.



WARNING: Do not keep the compressor operating for more than 10 minutes. This could cause the compressor to malfunction causing serious personal injury.

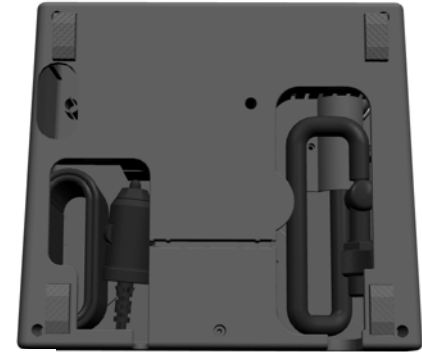

E258994

1. Release the tire inflation pipe and the 12 volt DC power point connector from the underside of the compressor.

Wheels and Tires



E259148

2. Uncoil the sealant bottle tire inflation pipe.

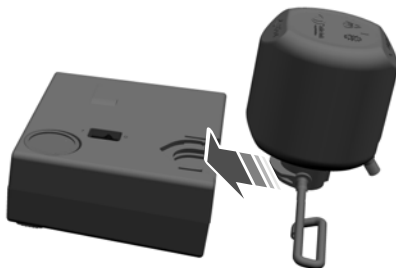

E259014

3. Attach the sealant bottle to the compressor.
4. Attach the compressor tire inflation pipe to the valve on the sealant bottle.

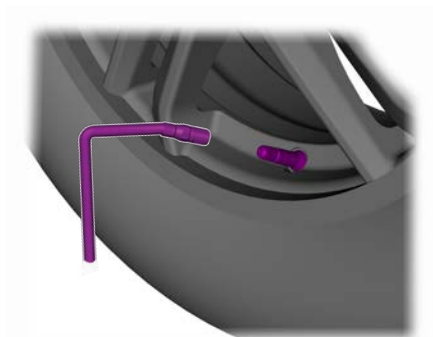

E257006

5. Remove the tire valve dust cap and attach the sealant bottle tire inflation pipe to the tire valve.



E257022

6. Plug the 12 volt DC power point connector into the 12 volt DC socket. See **Auxiliary Power Points** (page 154).
7. Start the engine.

Wheels and Tires

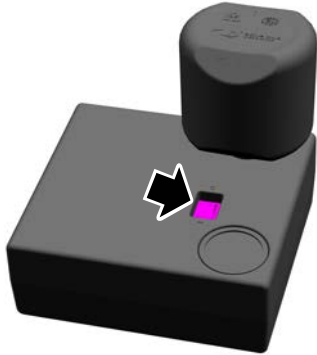

E259160

8. Switch the compressor on.



E257121

9. Inflate the tire to between 2–3 bar (29–44 psi).

Note: *If the tire pressure does not reach 1.8 bar (26 psi) within 10 minutes, the tire could be damaged beyond a temporary repair. Have your vehicle immediately checked. Do not drive your vehicle.*

10. When the tire reaches the recommended tire pressure of between 2–3 bar (29–44 psi), switch the compressor and the ignition off.
11. Disconnect the sealant bottle tire inflation pipe from the tire valve and the 12 volt DC power point connector.

Note: *Do not remove the sealant bottle from the compressor.*

12. Reinstall the tire valve dust cap.
13. Place the warning label on the steering wheel and correctly stow the kit in the luggage compartment.



E257942

14. Immediately drive your vehicle for 4–6 km (2–4 mi). Do not exceed 80 km/h (50 mph).

Wheels and Tires



E257121

15. After driving between 4–6 km (2–4 mi), stop your vehicle and recheck the tire pressure. See **Tire Pressures** (page 353).

Note: *If the tire pressure has dropped to 1.8 bar (26 psi) or below, the tire could be damaged beyond a temporary repair. Have your vehicle immediately checked. Do not drive your vehicle.*

After Using the Tire Sealant and Inflator Kit

 **WARNING:** If you experience heavy vibrations, unsteady steering behavior or noises while driving, reduce your speed gradually and stop your vehicle as soon as it is safe to do so. Recheck the tire and its pressure. If the tire pressure is less than 1.3 bar (18.9 psi) or if there are any cracks, bumps or similar damage visible, do not continue driving with this tire. This could cause loss of vehicle control.

The kit only provides temporary mobility. Regulations concerning tire repair or replacement after using the kit could differ from country to country. We recommend you consult a tire specialist.

After using the kit:

- Do not drive your vehicle more than 200 km (124 mi) before repairing or replacing the punctured tire.
- Inform all other users of your vehicle that a tire was sealed using the kit. Make them aware of the special driving conditions that must be adhered to.

- Regularly check the tire pressure until the sealed tire is repaired or replaced by a tire specialist. Before the tire is removed from the wheel rim, you must inform the tire specialist that the tire contains sealant.
- Remove the sealant bottle and the sealant bottle tire inflation pipe from the compressor and discard it in your household waste or return it to an authorized dealer.
- Purchase a replacement sealant bottle and sealant bottle tire inflation pipe from an authorized dealer.

TIRE CARE

Note: *Front tires shown on the left side of the diagram.*

Wheels and Tires

Non-directional tires

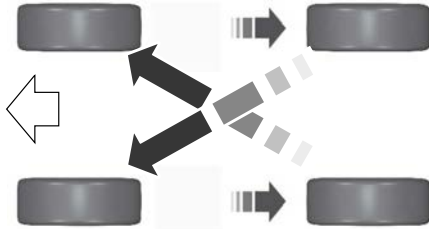

E142547

Directional tires

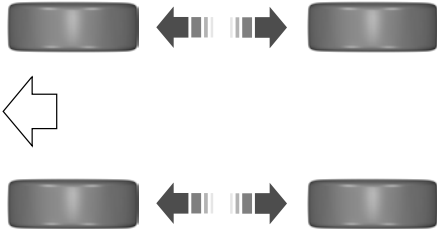

E70415

To make sure the front and rear tires of your vehicle wear evenly and last longer, we recommend that you swap the tires from front to rear and vice versa at regular intervals between 5,000 km (3,000 mi) and 10,000 km (6,000 mi).

 **WARNING:** Do not scrub the sidewalls of the tires when you are parking.

If you have to mount a curb, do so slowly and approach it with the wheels at right-angles to the curb.

Examine the tires regularly for cuts, foreign objects and uneven wear of the tread. Uneven wear could mean that the wheel alignment is outside specification.

Check the tire pressures (including the spare) when cold, every two weeks.

USING WINTER TIRES



E278852

We recommend that you use winter or all-season tires carrying this symbol when the temperature is 7°C (45°F) or lower, or in snow and ice conditions.

Inflate the winter tires to the same tire pressures as those listed in the tire pressures table. See **Tire Pressures** (page 360).

 **WARNING:** Snow tires must be the same size, load index and speed rating as those originally provided by Ford. Use of any tire or wheel not recommended by Ford can affect the safety and performance of your vehicle, which could result in an

Wheels and Tires

increased risk of loss of control, vehicle rollover, personal injury and death. Additionally, the use of non-recommended tires and wheels can cause steering, suspension, axle, transfer case or power transfer unit failure. Follow the Ford recommended tire inflation pressure found on the Safety Compliance Certification Label (on the door hinge pillar, door latch post or the door edge that meets the door latch post, next to the driver seat), or Tire Label on the B-Pillar or the edge of the driver door. Failure to follow the tire pressure recommendations can cause uneven treadwear patterns and adversely affect the way your vehicle handles.

USING SNOW CHAINS

 **WARNING:** Do not exceed 50 km/h (30 mph). Failure to follow this instruction could result in the loss of control of your vehicle, personal injury or death.

 **WARNING:** Do not use snow chains on snow-free roads.

 **WARNING:** Only fit snow chains to specified tires.

 **WARNING:** If your vehicle is fitted with wheel trims, remove them before fitting snow chains.

Only use snow chains on the front wheels.

Only use snow chains on the following specified tire sizes:

- 195/60 R 15.
- 195/60 R 15 ECO.

Note: *Maintain correct tire pressures.*

Note: *The anti-lock brake system continues to correctly operate.*

Note: *We recommend that you switch the stability control system off. See **Using Stability Control** (page 207).*

Do not use snow chains greater than 10 mm (0.4 in).

Do not use self-tensioning snow chains.

CHANGING A ROAD WHEEL - VEHICLES WITH: SPARE WHEEL

Vehicles With a Spare Wheel

 **WARNING:** Do not fit more than one spare wheel on your vehicle at any one time.

 **WARNING:** Do not carry out any tire repairs on a spare wheel.

 **WARNING:** If you are not sure what type of spare wheel your vehicle has, do not exceed 80 km/h (50 mph).

 **WARNING:** Only fit snow chains to specified tires.

If the spare wheel is the same type and size as your vehicle road wheel, you can fit the spare wheel and continue to drive in the normal manner.

If the spare wheel is not the same type and size as your vehicle road wheel, it has a label showing the maximum driving speed limit.

Refer to the following information before changing the road wheel.

Wheels and Tires

Note: Your vehicle may exhibit some different driving characteristics if you fit the spare wheel.

Note: The ground clearance of your vehicle may be reduced when the spare wheel is fitted. Take care when parking next to a curb.

Note: The spare wheel is located under the floor cover in the luggage compartment.

Note: If the spare wheel is fitted to your vehicle, do not drive through an automatic car wash.

Note: If the spare wheel is fitted to your vehicle, drive the shortest distance possible.

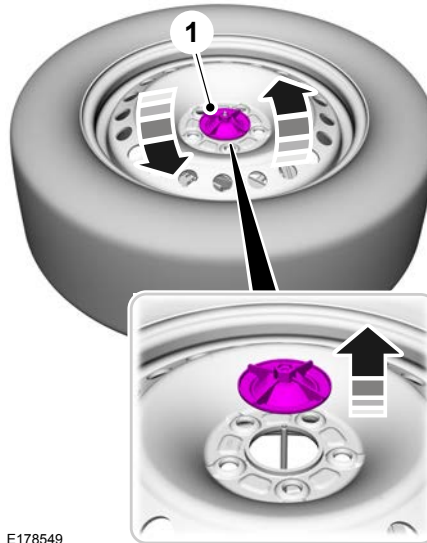

E178549

1. Turn the spare wheel securing nut counterclockwise and remove it. Remove the wheel from the spare wheel well.

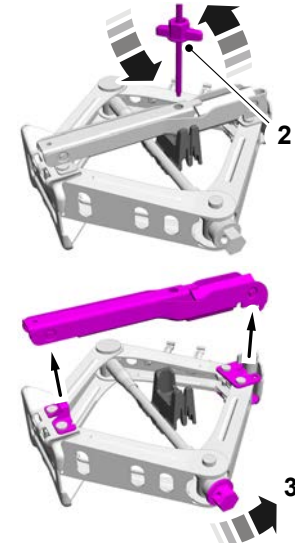

E178548

2. Turn the vehicle jack securing bolt counterclockwise and remove it.
3. Turn the vehicle jack screw clockwise to remove the vehicle jack handle and lug nut tool from the vehicle jack.

Wheels and Tires

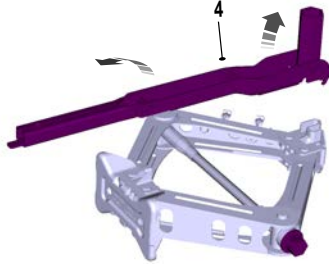

E245204

4. Unfold the vehicle jack handle and the hexagonal end into the correct position prior to use. Use the hexagonal end to operate the vehicle jack screw and to remove the lug nuts.

Note: Use the hook at the hexagonal end to remove the wheel trim.

Vehicles Without a Spare Wheel

Vehicles without a spare wheel are fitted with a temporary mobility kit. See **Tire Sealant and Inflator Kit** (page 339).

Note: Vehicles with a temporary mobility kit do not have a spare wheel, vehicle jack or wheel brace.

Vehicle Jack

WARNING: The jack supplied with this vehicle is only intended for changing wheels. Do not use the vehicle jack other than when you are changing a wheel in an emergency.

WARNING: Check that the vehicle jack is not damaged or deformed and the thread is lubricated and clean.

WARNING: Never place anything between the vehicle jack and the ground.

WARNING: Never place anything between the vehicle jack and your vehicle.

WARNING: Use a jack with a minimum lifting capacity of 1,500 kg (3,307 lb) and a lifting plate with a minimum diameter of 80 mm (3.1 in).

WARNING: Do not work on your vehicle when the jack is the only support. If the vehicle slips off the jack, you or someone else could be seriously injured.

WARNING: No person should place any portion of their body under a vehicle that is supported by a jack.

WARNING: Do not get under a vehicle that is only supported by a vehicle jack.

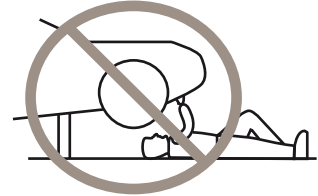

Workshop Type Hydraulic Trolley Jack

WARNING: Use a jack with a minimum lifting capacity of 1,500 kg (3,307 lb) and a lifting plate with a minimum diameter of 80 mm (3.1 in).

Wheels and Tires

We recommend you use a workshop type hydraulic trolley jack for changing between summer and winter tires.



E93020

Refer to vehicle jack manufacturer's instructions.

Jacking and Lifting Points

 **WARNING:** You must use the specified jacking points.

Wheels and Tires

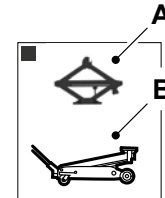
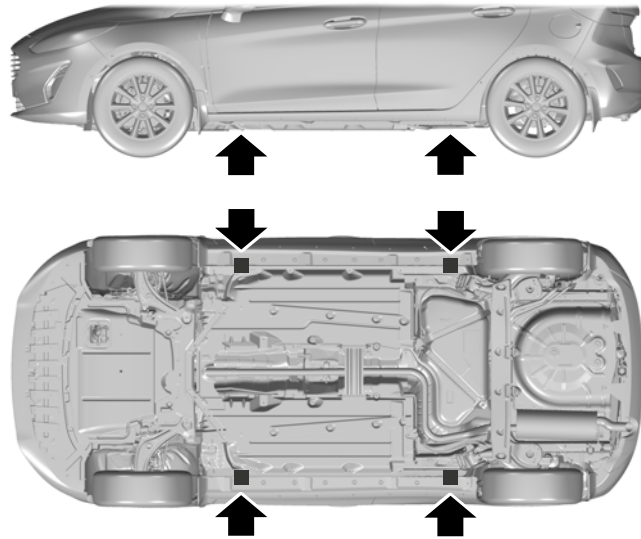

E283868

- A Emergency use only.
- B Maintenance.

Wheels and Tires

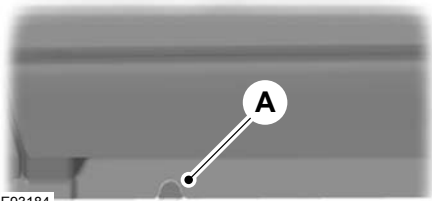

E93184

Indentations in the sills show the location of the jacking points.

All Vehicles - Excluding: Active, ST and ST Line

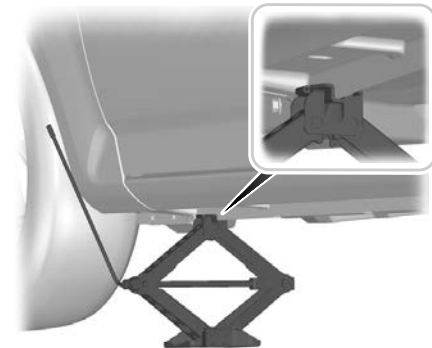

E292932



E93020

Active, ST and ST Line

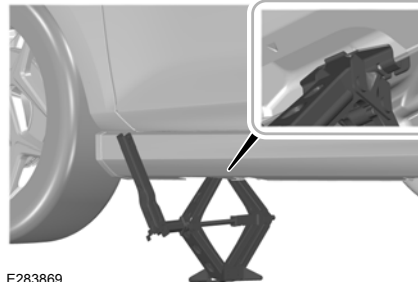

E283869

Removing the Wheel Trim

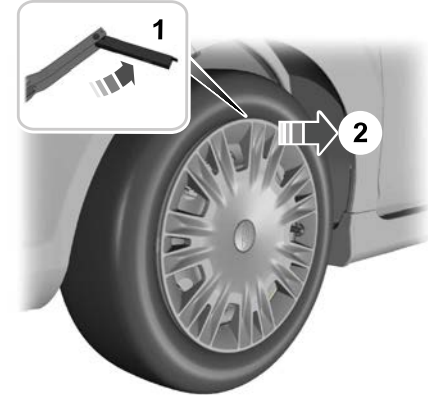



E285279

1. Unfold the lug nut wrench.
2. Use the tongue on the lug nut wrench to remove the wheel trim.

Wheels and Tires

Removing a Road Wheel

 **WARNING:** Park your vehicle in such a position that neither the traffic nor you are hindered or endangered.

 **WARNING:** Park your vehicle so that you do not obstruct the flow of traffic or place yourself in any danger and set up a warning triangle.

 **WARNING:** Make sure that your vehicle is on firm and level ground with the front wheels pointing straight ahead.

 **WARNING:** Switch the ignition off and apply the parking brake.

 **WARNING:** If your vehicle has a manual transmission, shift into first or reverse gear. If your vehicle has an automatic transmission, shift into park (P).

 **WARNING:** Make sure all passengers are out of your vehicle.

 **WARNING:** Chock the diagonally opposite wheel to the punctured tire with an appropriate wheel block or wheel chock.

 **WARNING:** Do not work on your vehicle when the jack is the only support. If the vehicle slips off the jack, you or someone else could be seriously injured.

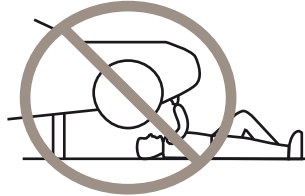

 **WARNING:** Make sure that the vehicle jack is vertical to the jacking point and the base is flat on the ground.

1. Install the locking lug nut key.

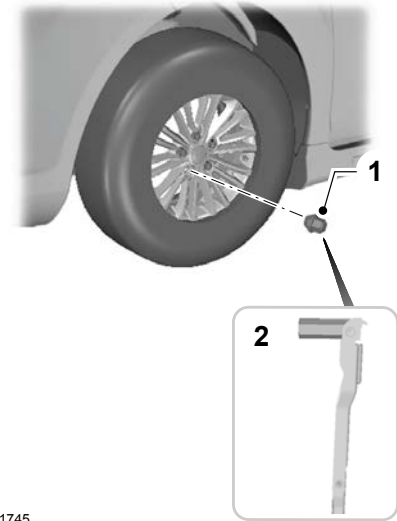

E181745

2. Loosen the lug nuts.
3. Raise your vehicle until the tire is clear of the ground.
4. Remove the lug nuts and the road wheel.

Note: Do not lay alloy wheels face down on the ground. This may damage the paint.

Wheels and Tires

Installing a Road Wheel

WARNING: When you install a wheel, always remove any corrosion, dirt or foreign materials present on the mounting surfaces of the wheel or the surface of the wheel hub, brake drum or brake disc that contacts the wheel. Make sure to secure any fasteners that attach the rotor to the hub so they do not interfere with the mounting surfaces of the wheel. Installing wheels without correct metal-to-metal contact at the wheel mounting surfaces can cause the wheel nuts to loosen and the wheel to come off while your vehicle is in motion, resulting in loss of vehicle control, personal injury or death.

WARNING: Make sure that the arrows on directional tires point in the direction of rotation when your vehicle is moving forward. If you have to fit a spare tire with the arrows pointing in the opposite direction have the tire refitted as soon as possible.

WARNING: Use only approved wheel and tire sizes. Using other sizes could damage your vehicle and will make the National Type Approval invalid.

WARNING: Make sure there is no grease or oil on the threads or the surface between the wheel lugs and nuts. This can cause the lug nuts to loosen while driving.

WARNING: Do not fit run flat tires on vehicles that were not originally fitted with them. Contact an authorized dealer for more details about compatibility.

WARNING: Do not install alloy wheels using lug nuts designed for use with steel wheels.

WARNING: Have the lug nuts checked for tightness and the tire pressure checked as soon as possible.

WARNING: Only use the specific lug nuts and wheels supplied with your vehicle. If in doubt, contact an authorized dealer.

Note: *The lug nuts of alloy wheels and spoked steel wheels can also be used for the steel spare wheel for a short time (maximum two weeks).*

Note: *Make sure that the cones on the lug nuts are against the wheel.*

1. Install the wheel.
2. Install the lug nuts finger tight.
3. Install the locking lug nut key.

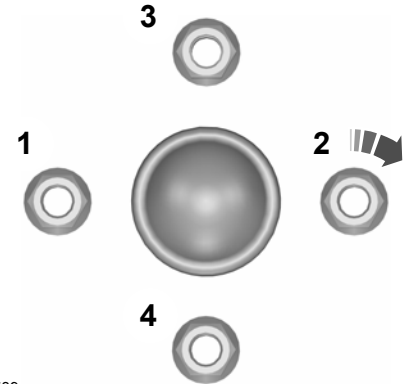

E90589

4. Install all of the lug nuts and partially tighten them in the sequence shown.
5. Lower your vehicle and remove the vehicle jack.
6. Fully tighten all of the lug nuts in the sequence shown. See **Wheels and Tires** (page 371).
7. Install the wheel trim.

Wheels and Tires

TIRE PRESSURES - 1.0L ECOBOOST™, MANUAL TRANSMISSION

The recommended tire inflation pressures are on the tire information label on the driver side B-pillar.

Check all tire pressures when they are cold, at least once every two weeks.

Note: You may need to remove the spare wheel from the spare wheel well to check the tire pressure.

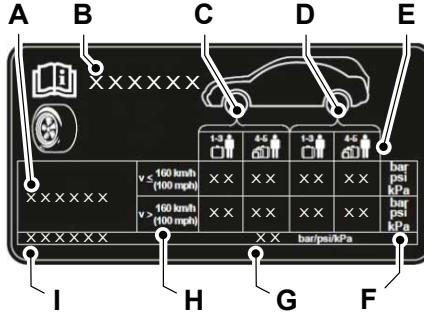

E254054

- A Tire size.
- B Vehicle model.

- C Front tire pressure.
- D Rear tire pressure.
- E Vehicle load.
- F Measure unit.
- G Spare wheel tire pressure.
- H Intended constant vehicle speed.
- I Spare wheel tire size.

Wheels and Tires

Up to 160 km/h (100 mph)

Tire Size	Normal Load		Full Load	
	Front	Rear	Front	Rear
	bar (psi)	bar (psi)	bar (psi)	bar (psi)
195/60R15 88V Winter	2.1 (30)	1.8 (26)	2.8 (41)	2.8 (41)
195/60R15 88V Summer	2.3 (33)	1.8 (26)	2.8 (41)	2.8 (41)
195/60R15 92V XL All Season	2.1 (30)	1.8 (26)	2.8 (41)	2.8 (41)
195/55R16 87H	2.4 (35)	2.1 (30)	2.6 (38)	2.6 (38)
195/55R16 87V	2.3 (33)	1.8 (26)	2.6 (38)	2.6 (38)
195/55R16 91V XL Summer	2.3 (33)	1.8 (26)	2.6 (38)	2.6 (38)
195/55R16 91V XL All Season	2.1 (30)	1.8 (26)	2.3 (33)	2.6 (38)
205/45R17 88V XL Summer	2.5 (36)	1.8 (26)	2.5 (36)	2.6 (38)
205/45R17 88V XL All Season	2.3 (33)	1.8 (26)	2.4 (35)	2.6 (38)
205/45R17 88Y XL	2.3 (33)	1.8 (26)	2.4 (35)	2.6 (38)
205/40R18 86W XL	2.5 (36)	1.8 (26)	2.6 (38)	2.8 (41)
205/40R18 86Y XL	2.3 (33)	1.8 (26)	2.6 (38)	2.8 (41)

Wheels and Tires

Continuous Speed in Excess of 160 km/h (100 mph) or With Trailer Towing up to 100 km/h (60 mph)

Tire Size	Normal Load		Full Load	
	Front	Rear	Front	Rear
	bar (psi)	bar (psi)	bar (psi)	bar (psi)
195/60R15 88V Winter	2.1 (30)	2 (29)	2.8 (41)	2.8 (41)
195/60R15 88V Summer	2.3 (33)	2 (29)	2.8 (41)	2.8 (41)
195/60R15 92V XL All Season	2.1 (30)	2 (29)	2.8 (41)	2.8 (41)
195/55R16 87H	2.4 (35)	2.1 (30)	2.6 (38)	2.6 (38)
195/55R16 87V	2.3 (33)	2 (29)	2.6 (38)	2.6 (38)
195/55R16 91V XL Summer	2.3 (33)	2 (29)	2.8 (41)	2.8 (41)
195/55R16 91V XL All Season	2.1 (30)	2 (29)	2.3 (33)	2.6 (38)
205/45R17 88V XL Summer	2.5 (36)	2 (29)	2.6 (38)	2.6 (38)
205/45R17 88V XL All Season	2.5 (36)	2 (29)	2.6 (38)	2.6 (38)
205/45R17 88Y XL	2.3 (33)	2 (29)	2.4 (35)	2.6 (38)
205/40R18 86W XL	2.6 (38)	2 (29)	2.7 (39)	2.8 (41)
205/40R18 86Y XL	2.3 (33)	2 (29)	2.6 (38)	2.8 (41)

Wheels and Tires

Temporary Spare Wheel (If Equipped)



WARNING: Do not switch off stability control or select sport mode, when using a temporary spare wheel or after inflating a tire using the temporary mobility kit.

Tire Size	bar (psi)
175/65R14 86T XL	3.2 (46)

Do not exceed the maximum speed stated on the label attached to the temporary spare wheel.

TIRE PRESSURES - 1.0L ECOBOOST™, AUTOMATIC TRANSMISSION

The recommended tire inflation pressures are on the tire information label on the driver side B-pillar.

Check all tire pressures when they are cold, at least once every two weeks.

Note: *You may need to remove the spare wheel from the spare wheel well to check the tire pressure.*

Wheels and Tires

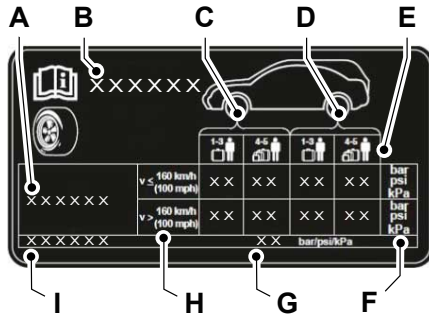

- A Tire size.
- B Vehicle model.
- C Front tire pressure.
- D Rear tire pressure.
- E Vehicle load.
- F Measure unit.
- G Spare wheel tire pressure.
- H Intended constant vehicle speed.
- I Spare wheel tire size.

E254054

Up to 160 km/h (100 mph)

Tire Size	Normal Load		Full Load	
	Front	Rear	Front	Rear
	bar (psi)	bar (psi)	bar (psi)	bar (psi)
195/60R15 88V Winter	2.3 (33)	1.8 (26)	2.8 (41)	2.8 (41)
195/60R15 88V Summer	2.6 (38)	1.8 (26)	2.8 (41)	2.8 (41)
195/60R15 92V XL All Season	2.3 (33)	1.8 (26)	2.8 (41)	2.8 (41)
195/55R16 87H	2.4 (35)	2.1 (30)	2.6 (38)	2.6 (38)

Wheels and Tires

Tire Size	Normal Load		Full Load	
	Front	Rear	Front	Rear
	bar (psi)	bar (psi)	bar (psi)	bar (psi)
195/55R16 87V	2.6 (38)	1.8 (26)	2.6 (38)	2.6 (38)
195/55R16 91V XL Summer	2.6 (38)	1.8 (26)	2.6 (38)	2.6 (38)
195/55R16 91V XL All Season	2.3 (33)	1.8 (26)	2.3 (33)	2.6 (38)
205/45R17 88V XL Summer	2.5 (36)	1.8 (26)	2.5 (36)	2.6 (38)
205/45R17 88V XL All Season	2.3 (33)	1.8 (26)	2.4 (35)	2.6 (38)
205/45R17 88Y XL	2.3 (33)	1.8 (26)	2.4 (35)	2.6 (38)
205/40R18 86W XL	2.5 (36)	1.8 (26)	2.6 (38)	2.8 (41)
205/40R18 86Y XL	2.3 (33)	1.8 (26)	2.6 (38)	2.8 (41)

Wheels and Tires

Continuous Speed in Excess of 160 km/h (100 mph) or With Trailer Towing up to 100 km/h (60 mph)

Tire Size	Normal Load		Full Load	
	Front	Rear	Front	Rear
	bar (psi)	bar (psi)	bar (psi)	bar (psi)
195/60R15 88V Winter	2.3 (33)	2 (29)	2.8 (41)	2.8 (41)
195/60R15 88V Summer	2.6 (38)	2 (29)	2.8 (41)	2.8 (41)
195/60R15 92V XL All Season	2.3 (33)	2 (29)	2.8 (41)	2.8 (41)
195/55R16 87H	2.4 (35)	2.1 (30)	2.6 (38)	2.6 (38)
195/55R16 87V	2.6 (38)	2 (29)	2.6 (38)	2.6 (38)
195/55R16 91V XL Summer	2.6 (38)	2 (29)	2.6 (38)	2.6 (38)
195/55R16 91V XL All Season	2.3 (33)	2 (29)	2.3 (33)	2.6 (38)
205/45R17 88V XL Summer	2.5 (36)	2 (29)	2.6 (38)	2.6 (38)
205/45R17 88V XL All Season	2.5 (36)	2 (29)	2.6 (38)	2.6 (38)
205/45R17 88Y XL	2.3 (33)	2 (29)	2.4 (35)	2.6 (38)
205/40R18 86W XL	2.6 (38)	2 (29)	2.7 (39)	2.8 (41)
205/40R18 86Y XL	2.3 (33)	2 (29)	2.6 (38)	2.8 (41)

Wheels and Tires

Temporary Spare Wheel (If Equipped)



WARNING: Do not switch off stability control or select sport mode, when using a temporary spare wheel or after inflating a tire using the temporary mobility kit.

Tire Size	bar (psi)
175/65R14 86T XL	3.2 (46)

Do not exceed the maximum speed stated on the label attached to the temporary spare wheel.

TIRE PRESSURES

The recommended tire inflation pressures are on the tire information label on the driver side B-pillar.

Check all tire pressures when they are cold, at least once every two weeks.

Note: *You may need to remove the spare wheel from the spare wheel well to check the tire pressure.*

Wheels and Tires

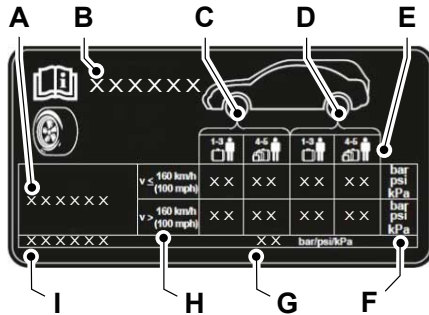

- A Tire size.
- B Vehicle model.
- C Front tire pressure.
- D Rear tire pressure.
- E Vehicle load.
- F Measure unit.
- G Spare wheel tire pressure.
- H Intended constant vehicle speed.
- I Spare wheel tire size.

E254054

Up to 160 km/h (100 mph)

Tire Size	Normal Load		Full Load	
	Front	Rear	Front	Rear
	bar (psi)	bar (psi)	bar (psi)	bar (psi)
195/60R15 88V Winter	2.1 (30)	1.8 (26)	2.8 (41)	2.8 (41)
195/60R15 88V Summer	2.3 (33)	1.8 (26)	2.8 (41)	2.8 (41)
195/60R15 92V XL All Season	2.1 (30)	1.8 (26)	2.8 (41)	2.8 (41)
195/55R16 87H	2.4 (35)	2.1 (30)	2.6 (38)	2.6 (38)

Wheels and Tires

Tire Size	Normal Load		Full Load	
	Front	Rear	Front	Rear
	bar (psi)	bar (psi)	bar (psi)	bar (psi)
195/55R16 87V	2.3 (33)	1.8 (26)	2.6 (38)	2.6 (38)
195/55R16 91V XL Summer	2.3 (33)	1.8 (26)	2.6 (38)	2.6 (38)
195/55R16 91V XL All Season	2.1 (30)	1.8 (26)	2.3 (33)	2.6 (38)
205/45R17 88V XL Summer	2.5 (36)	1.8 (26)	2.5 (36)	2.6 (38)
205/45R17 88V XL All Season	2.3 (33)	1.8 (26)	2.4 (35)	2.6 (38)
205/45R17 88Y XL	2.3 (33)	1.8 (26)	2.4 (35)	2.6 (38)
205/40R18 86W XL	2.5 (36)	1.8 (26)	2.6 (38)	2.8 (41)
205/40R18 86Y XL	2.3 (33)	1.8 (26)	2.6 (38)	2.8 (41)

Wheels and Tires

Continuous Speed in Excess of 160 km/h (100 mph) or With Trailer Towing up to 100 km/h (60 mph)

Tire Size	Normal Load		Full Load	
	Front	Rear	Front	Rear
	bar (psi)	bar (psi)	bar (psi)	bar (psi)
195/60R15 88V Winter	2.1 (30)	2 (29)	2.8 (41)	2.8 (41)
195/60R15 88V Summer	2.3 (33)	2 (29)	2.8 (41)	2.8 (41)
195/60R15 92V XL All Season	2.1 (30)	2 (29)	2.8 (41)	2.8 (41)
195/55R16 87H	2.4 (35)	2.1 (30)	2.6 (38)	2.6 (38)
195/55R16 87V	2.3 (33)	2 (29)	2.6 (38)	2.6 (38)
195/55R16 91V XL Summer	2.3 (33)	2 (29)	2.8 (41)	2.8 (41)
195/55R16 91V XL All Season	2.1 (30)	2 (29)	2.3 (33)	2.6 (38)
205/45R17 88V XL Summer	2.5 (36)	2 (29)	2.6 (38)	2.6 (38)
205/45R17 88V XL All Season	2.5 (36)	2 (29)	2.6 (38)	2.6 (38)
205/45R17 88Y XL	2.3 (33)	2 (29)	2.4 (35)	2.6 (38)
205/40R18 86W XL	2.6 (38)	2 (29)	2.7 (39)	2.8 (41)
205/40R18 86Y XL	2.3 (33)	2 (29)	2.6 (38)	2.8 (41)

Wheels and Tires

Temporary Spare Wheel (If Equipped)



WARNING: Do not switch off stability control or select sport mode, when using a temporary spare wheel or after inflating a tire using the temporary mobility kit.

Tire Size	bar (psi)
175/65R14 86T XL	3.2 (46)

Do not exceed the maximum speed stated on the label attached to the temporary spare wheel.

TIRE PRESSURES - 1.5L DIESEL

The recommended tire inflation pressures are on the tire information label on the driver side B-pillar.

Check all tire pressures when they are cold, at least once every two weeks.

Note: *You may need to remove the spare wheel from the spare wheel well to check the tire pressure.*

Wheels and Tires

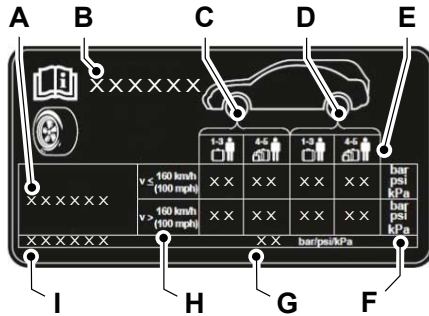

- A Tire size.
- B Vehicle model.
- C Front tire pressure.
- D Rear tire pressure.
- E Vehicle load.
- F Measure unit.
- G Spare wheel tire pressure.
- H Intended constant vehicle speed.
- I Spare wheel tire size.

E254054

Up to 160 km/h (100 mph)

Tire Size	Normal Load		Full Load	
	Front	Rear	Front	Rear
	bar (psi)	bar (psi)	bar (psi)	bar (psi)
195/60R15 88V Winter	2.3 (33)	1.8 (26)	2.8 (41)	2.8 (41)
195/60R15 88V Summer	2.6 (38)	1.8 (26)	2.8 (41)	2.8 (41)
195/60R15 92V XL All Season	2.3 (33)	1.8 (26)	2.8 (41)	2.8 (41)
195/55R16 87H	2.4 (35)	2.1 (30)	2.6 (38)	2.6 (38)

Wheels and Tires

Tire Size	Normal Load		Full Load	
	Front	Rear	Front	Rear
	bar (psi)	bar (psi)	bar (psi)	bar (psi)
195/55R16 87V	2.6 (38)	1.8 (26)	2.6 (38)	2.6 (38)
195/55R16 91V XL Summer	2.6 (38)	1.8 (26)	2.6 (38)	2.6 (38)
195/55R16 91V XL All Season	2.3 (33)	1.8 (26)	2.3 (33)	2.6 (38)
205/45R17 88V XL Summer	2.5 (36)	1.8 (26)	2.5 (36)	2.6 (38)
205/45R17 88V XL All Season	2.3 (33)	1.8 (26)	2.4 (35)	2.6 (38)
205/45R17 88Y XL	2.3 (33)	1.8 (26)	2.4 (35)	2.6 (38)
205/40R18 86W XL	2.5 (36)	1.8 (26)	2.6 (38)	2.8 (41)
205/40R18 86Y XL	2.3 (33)	1.8 (26)	2.6 (38)	2.8 (41)

Wheels and Tires

Continuous Speed in Excess of 160 km/h (100 mph) or With Trailer Towing up to 100 km/h (60 mph)

Tire Size	Normal Load		Full Load	
	Front	Rear	Front	Rear
	bar (psi)	bar (psi)	bar (psi)	bar (psi)
195/60R15 88V Winter	2.3 (33)	2 (29)	2.8 (41)	2.8 (41)
195/60R15 88V Summer	2.6 (38)	2 (29)	2.8 (41)	2.8 (41)
195/60R15 92V XL All Season	2.3 (33)	2 (29)	2.8 (41)	2.8 (41)
195/55R16 87H	2.4 (35)	2.1 (30)	2.6 (38)	2.6 (38)
195/55R16 87V	2.6 (38)	2 (29)	2.6 (38)	2.6 (38)
195/55R16 91V XL Summer	2.6 (38)	2 (29)	2.6 (38)	2.6 (38)
195/55R16 91V XL All Season	2.3 (33)	2 (29)	2.3 (33)	2.6 (38)
205/45R17 88V XL Summer	2.5 (36)	2 (29)	2.6 (38)	2.6 (38)
205/45R17 88V XL All Season	2.5 (36)	2 (29)	2.6 (38)	2.6 (38)
205/45R17 88Y XL	2.3 (33)	2 (29)	2.4 (35)	2.6 (38)
205/40R18 86W XL	2.6 (38)	2 (29)	2.7 (39)	2.8 (41)
205/40R18 86Y XL	2.3 (33)	2 (29)	2.6 (38)	2.8 (41)

Wheels and Tires

Temporary Spare Wheel (If Equipped)



WARNING: Do not switch off stability control or select sport mode, when using a temporary spare wheel or after inflating a tire using the temporary mobility kit.

Tire Size	bar (psi)
175/65R14 86T XL	3.2 (46)

Do not exceed the maximum speed stated on the label attached to the temporary spare wheel.

TIRE PRESSURES - 1.5L ECOBOOST™

The recommended tire inflation pressures are on the tire information label on the driver side B-pillar.

Check all tire pressures when they are cold, at least once every two weeks.

Note: *You may need to remove the spare wheel from the spare wheel well to check the tire pressure.*

Wheels and Tires

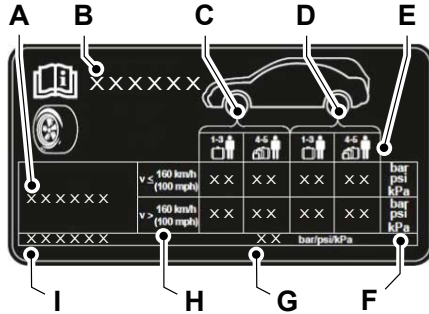

- A Tire size.
- B Vehicle model.
- C Front tire pressure.
- D Rear tire pressure.
- E Vehicle load.
- F Measure unit.
- G Spare wheel tire pressure.
- H Intended constant vehicle speed.
- I Spare wheel tire size.

E254054

Up to 160 km/h (100 mph)

Tire Size	Normal Load		Full Load	
	Front	Rear	Front	Rear
	bar (psi)	bar (psi)	bar (psi)	bar (psi)
195/60R15 88V	2 (29)	2 (29)	2 (29)	2 (29)
205/45R17 88Y XL	2.5 (36)	2.2 (32)	2.6 (38)	2.3 (33)
205/40R18 86Y XL	2.5 (36)	1.9 (28)	2.6 (38)	2.3 (33)

Wheels and Tires

Continuous Speed in Excess of 160 km/h (100 mph) or With Trailer Towing up to 100 km/h (60 mph)

Tire Size	Normal Load		Full Load	
	Front	Rear	Front	Rear
	bar (psi)	bar (psi)	bar (psi)	bar (psi)
195/60R15 88V	2 (29)	2 (29)	2 (29)	2 (29)
205/45R17 88Y XL	2.5 (36)	2.2 (32)	2.6 (38)	2.3 (33)
205/40R18 86 Y XL	2.5 (36)	2.1 (30)	2.6 (38)	2.3 (33)

Temporary Spare Wheel (If Equipped)

 **WARNING:** Do not switch off stability control or select sport mode, when using a temporary spare wheel or after inflating a tire using the temporary mobility kit.

Tire Size	bar (psi)
T125/80R15 95M	4.2 (60)

Do not exceed the maximum speed stated on the label attached to the temporary spare wheel.

Wheels and Tires

LUG NUTS

Lug Nut Torque

Nm (lb.ft)
135 (100)

Locking Lug Nuts

You can obtain a replacement locking lug nut key and replacement locking lug nuts from an authorized dealer using the reference number certificate.

Tire Pressure Monitoring System (If Equipped)

WHAT IS THE TIRE PRESSURE MONITORING SYSTEM



The tire pressure monitoring system measures the vehicle's tire pressures. A warning lamp illuminates if one or more tires are significantly underinflated or if there is a system malfunction.

TIRE PRESSURE MONITORING SYSTEM PRECAUTIONS



WARNING: The tire pressure monitoring system is not a substitute for manually checking tire pressures. You should periodically check tire pressures using a pressure gauge. Failure to correctly maintain tire pressures could increase the risk of tire failure, loss of control, vehicle rollover and personal injury.



WARNING: Do not use the tire pressure displayed in the information display as a tire pressure gauge. Failure to follow this instruction could result in personal injury or death.

Note: The use of tire sealants can damage the tire pressure monitoring system.

TIRE PRESSURE MONITORING SYSTEM LIMITATIONS

The warning lamp can illuminate when:

- You use a spare wheel or a tire sealant and inflator kit.
- The outside air temperature drops significantly. The tire pressure could decrease and activate the low tire pressure warning lamp. Check each tire to verify that none are flat. Inflate the tires, if needed, to the recommended pressures and carry out the reset procedure.

Note: Regularly checking the vehicle tire pressures can reduce the possibility for the warning lamp to illuminate due to outside air temperature changes.

Note: After you inflate the tires to the correct pressure, it may take up to two minutes of driving over 32 km/h (20 mph) for the warning lamp to turn off.

VIEWING THE TIRE PRESSURES

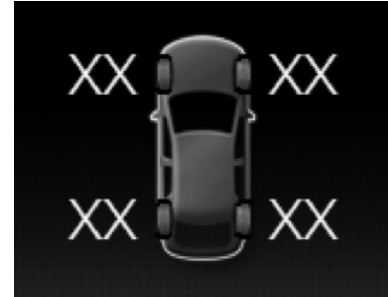

1. Using the information display controls on the steering wheel, select **Settings**.
2. Select **Information**.
3. Select **Tyre pressure**.

RESETTING TIRE PRESSURE MONITORING SYSTEM

You must reset the tire pressure monitoring system after each tire replacement, tire rotation or after inflating the tires to the correct tire pressure.

Tire Pressure Monitoring System (If Equipped)

Note: If you have a new sensor or have rotated the vehicle tires, park your vehicle for at least 20 minutes, before resetting the system.

Note: The tire pressure monitoring system automatically re-learns the tire pressure sensors the next time you drive your vehicle for approximately 15 minutes.

1. Using the information display controls on the steering wheel, select **Settings**.
2. Select **Information**.
3. Select **Tyre pressure**.
4. Select **Reset**.
5. Press and hold the **OK** button until the system reset confirmation appears.

TIRE PRESSURE MONITORING SYSTEM – TROUBLESHOOTING

Tire Pressure Monitoring System – Warning Lamps



The low tire pressure warning lamp combines functions.

Warning Lamp	Possible Cause	Action
Solid warning lamp	One or more tires are significantly underinflated	Inflate the tires to the recommended tire pressure. See Tire Pressures (page 353). Check the tires for damage and repair them if necessary. Carry out the system reset procedure.
Solid warning lamp or flashing warning lamp	Temporary spare wheel in use	Repair the damaged road wheel and tire and refit it to your vehicle to restore the correct operation of the system.
	Tire pressure monitoring system malfunction	If the tires are inflated to the recommended tire pressures and the temporary spare wheel is not in use, the system has detected a fault that requires service. Have your vehicle checked as soon as possible.

Tire Pressure Monitoring System (If Equipped)

Tire Pressure Monitoring System – Information Messages

Message	Action
Tyre pressure low	Inflate the tires to the recommended tire pressure. Check the tires for damage and repair them if necessary. Carry out the system reset procedure.
Tyre pressure monitor malfunction	The system has detected a fault that requires service. Have your vehicle checked as soon as possible.
Tyre pressure sensor malfunction	The temporary spare wheel is either in use or the system has detected a fault in the sensor that requires service. Have your vehicle checked as soon as possible.

Capacities and Specifications

VEHICLE DIMENSIONS

Dimension Description	Dimension
Overall length.	4,040–4,068 mm (159.1–160.2 in)
Overall width including the exterior mirrors.	1,941 mm (76.4 in)
Overall height excluding the antenna.	1,464–1,495 mm (57.6–58.9 in)
Wheelbase.	2,493 mm (98.1 in)
Front track.	1,503–1,513 mm (59.2–59.6 in)
Rear track.	1,466–1,476 mm (57.7–58.1 in)

Capacities and Specifications

TOWBAR DIMENSIONS

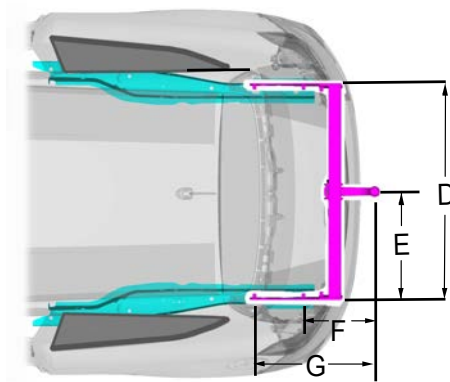
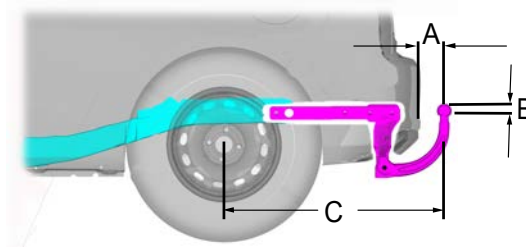

E237445

Capacities and Specifications

Measurement	Dimension Description	mm (in)
A	Bumper to center of tow ball.	75 (3.0)
B	Attachment point to center of tow ball.	9 (0.4)
C	Wheel center to center of tow ball.	783 (30.8)
D	Distance between side members.	1,032 (40.6)
E	Center of tow ball to side member.	516 (20.3)
F	Center of tow ball to center of first attachment point.	339 (13.3)
G	Center of tow ball to center of second attachment point.	573 (22.6)

Maximum Permissible Trailer Vertical Weight

Powertrain	kg (lb)
1.0L EcoBoost.	65 (143)
1.0L EcoBoost. ¹	45 (99)
1.1L Duratec.	65 (143)
1.5L Duratorq-TDCi 85PS.	45 (99)
1.5L Duratorq-TDCi 120PS.	40 (88)

¹Vehicles with automatic transmission.

Capacities and Specifications

CAPACITIES AND SPECIFICATIONS - 1.0L ECOBOOST™

Use oil and fluid that meets the defined specification and viscosity grade.

Engine

Engine Oil

Capacities

Variant	Including the Oil Filter
All.	4.6 L (1.0 gal)

Note: The quantity of engine oil required to raise the indicated level on the dipstick from minimum to maximum is 1 L (0.2 gal).

Materials

Name	Specification
Engine Oil - SAE 5W-20	WSS-M2C948-B

Engine Oil Top-Up

If you are unable to find engine oil that meets the specification defined by WSS-M2C948-B, you can top-up with a SAE 5W-20 engine oil that is defined by ACEA A5/B5.

If you do not use oil and fluid that meets the defined specification and viscosity grade, it could result in:

- Component damage not covered by the vehicle Warranty.
- Longer engine cranking periods.
- Increased emission levels.
- Reduced engine performance.
- Reduced fuel economy.
- Reduced brake performance.

Note: Do not use more than 0.5 L (0.1 gal) of the alternative engine oil between scheduled service intervals.

Capacities and Specifications

Engine Coolant

Capacities

Variant	Quantity
All.	5.8 L (1.3 gal)

Materials

Name	Specification
Antifreeze Super Plus Premium FU7J-19544-xx	WSS-M97B44-D

Fuel Tank

Capacities

Variant	Quantity
All.	42 L (9.2 gal)

Washer Reservoir

Capacities

Variant	Quantity
All.	3 L (0.7 gal)

Capacities and Specifications

Materials

Name	Specification
Screen Wash FU7J-19C544-AA/BA/DA/EA/GA/HA	WSS-M14P19-A

Brake System

Materials

Name	Specification
Brake Fluid DOT 4 LV High Performance BU7J-M6C65-xxxx	WSS-M6C65-A2

CAPACITIES AND SPECIFICATIONS - 1.1L DURATEC

Use oil and fluid that meets the defined specification and viscosity grade.

If you do not use oil and fluid that meets the defined specification and viscosity grade, it could result in:

- Component damage not covered by the vehicle Warranty.
- Longer engine cranking periods.
- Increased emission levels.
- Reduced engine performance.
- Reduced fuel economy.
- Reduced brake performance.

Capacities and Specifications

Engine

Engine Oil

Capacities

Variant	Including the Oil Filter
All.	4.1 L (0.9 gal)

Note: The quantity of engine oil required to raise the indicated level on the dipstick from minimum to maximum is 1 L (0.2 gal).

Materials

Name	Specification
Engine Oil - SAE 5W-20	WSS-M2C948-B

Engine Oil Top-Up

If you are unable to find engine oil that meets the specification defined by WSS-M2C948-B, you can top-up with a SAE 5W-20 engine oil that is defined by ACEA A5/B5.

Note: Do not use more than 0.5 L (0.1 gal) of the alternative engine oil between scheduled service intervals.

Engine Coolant

Capacities

Variant	Quantity
All.	5.5 L (1.2 gal)

Capacities and Specifications

Materials

Name	Specification
Antifreeze Super Plus Premium FU7J-19544-xx	WSS-M97B44-D

Fuel Tank

Capacities

Variant	Quantity
All.	42 L (9.2 gal)

Washer Reservoir

Capacities

Variant	Quantity
All.	3 L (0.7 gal)

Materials

Name	Specification
Screen Wash FU7J-19C544-AA/BA/DA/EA/GA/HA	WSS-M14P19-A

Capacities and Specifications

Brake System

Materials

Name	Specification
Brake Fluid DOT 4 LV High Performance BU7J-M6C65-xxxx	WSS-M6C65-A2

CAPACITIES AND SPECIFICATIONS - 1.5L DURATORQ-TDCI DIESEL

Use oil and fluid that meets the defined specification and viscosity grade.

If you do not use oil and fluid that meets the defined specification and viscosity grade, it could result in:

- Component damage not covered by the vehicle Warranty.
- Longer engine cranking periods.
- Increased emission levels.

- Reduced engine performance.
- Reduced fuel economy.
- Reduced brake performance.

Engine

Engine Oil

Capacities

Variant	Including the Oil Filter
All.	6.2 L (1.4 gal)

Note: The quantity of engine oil required to raise the indicated level on the dipstick from minimum to maximum is 1.75 L (0.4 gal).

Capacities and Specifications

Materials

Name	Specification
Engine Oil - SAE 0W-30	WSS-M2C950-A

Engine Oil Top-Up

If you are unable to find engine oil that meets the specification defined by WSS-M2C950-A, you can top-up with a SAE 0W-30 engine oil that is defined by ACEA C2.

Note: Do not use more than 1 L (0.2 gal) of the alternative engine oil between scheduled service intervals.

Engine Coolant

Capacities

Variant	Quantity
All.	6.1 L (1.3 gal)

Materials

Name	Specification
Antifreeze Super Plus Premium FU7J-19544-xx	WSS-M97B44-D

Capacities and Specifications

Fuel Tank

Capacities

Variant	Quantity
All.	40 L (8.8 gal)

Washer Reservoir

Capacities

Variant	Quantity
All.	3 L (0.7 gal)

Materials

Name	Specification
Screen Wash FU7J-19C544-AA/BA/DA/EA/GA/HA	WSS-M14P19-A

Brake System

Capacities and Specifications

Materials

Name	Specification
Brake Fluid DOT 4 LV High Performance BU7J-M6C65-xxxx	WSS-M6C65-A2

CAPACITIES AND SPECIFICATIONS - 1.5L ECOBOOST™

Use oil and fluid that meets the defined specification and viscosity grade.

If you do not use oil and fluid that meets the defined specification and viscosity grade, it could result in:

- Component damage not covered by the vehicle Warranty.
- Longer engine cranking periods.
- Increased emission levels.

- Reduced engine performance.
- Reduced fuel economy.
- Reduced brake performance.

Engine

Engine Oil

Capacities

Variant	Including the Oil Filter
All.	6.1 L (1.3 gal)

Note: The quantity of engine oil required to raise the indicated level on the dipstick from minimum to maximum is 0.9 L (0.2 gal).

Capacities and Specifications

Materials

Name	Specification
Engine Oil - SAE 5W-20	WSS-M2C948-B

Engine Oil Top-Up

If you are unable to find engine oil that meets the specification defined by WSS-M2C948-B, you can top-up with a SAE 5W-20 engine oil that is defined by ACEA A5/B5.

Note: Do not use more than 1 L (0.2 gal) of the alternative engine oil between scheduled service intervals.

Engine Coolant

Capacities

Variant	Quantity
All.	6 L (1.3 gal)

Materials

Name	Specification
Antifreeze Super Plus Premium FU7J-19544-xx	WSS-M97B44-D

Capacities and Specifications

Fuel Tank

Capacities

Variant	Quantity
All.	42 L (9.2 gal)

Washer Reservoir

Capacities

Variant	Quantity
All.	3 L (0.7 gal)

Materials

Name	Specification
Screen Wash FU7J-19C544-AA/BA/DA/EA/GA/HA	WSS-M14P19-A

Brake System

Capacities and Specifications

Materials

Name	Specification
Brake Fluid DOT 4 LV High Performance BU7J-M6C65-xxxx	WSS-M6C65-A2

BULB SPECIFICATION CHART

Exterior Lamps

Bulb	Specification	Power (Watts)
Front direction indicator. ¹	PY21W.	21
Front direction indicator. ²	PY21W.	21
Front direction indicator. ³	LED.	-
Daytime running lamp. ¹	H15.	15/55
Daytime running lamp. ²	LED.	-
Daytime running lamp. ³	LED.	-
Low beam headlamp. ¹	H7.	55
Low beam headlamp. ²	H7.	55

Capacities and Specifications

Bulb	Specification	Power (Watts)
Low beam headlamp. ³	LED.	-
High beam headlamp. ¹	H15.	15/55
High beam headlamp. ²	H1.	55
High beam headlamp. ³	LED.	-
Front fog lamp.	H8.	35
Side direction indicator. ⁴	WY5W.	5
Rear lamp and stoplamp.	P21/5W.	21/5
Rear lamp and stoplamp. ⁵	LED.	-
High mounted stoplamp.	LED.	-
Rear direction indicator.	PY21W.	21
Rear fog lamp.	P21W.	21

Capacities and Specifications

Bulb	Specification	Power (Watts)
Reversing lamp.	W16W.	16
License plate lamp.	LED.	-

¹ Reflector headlamp. See **Changing a Bulb** (page 327).

² Projector headlamp. See **Changing a Bulb** (page 327).

³ LED headlamp. See **Changing a Bulb** (page 327).

⁴ We recommend that you contact an authorized dealer to replace the bulb.

⁵ High series.

Note: *We recommend that you have LEDs changed by an authorized dealer.*

Interior Lamps

Bulb	Specification	Power (Watts)
Glove compartment lamp.	LED.	-
Interior lamp.	LED.	-
Vanity mirror lamp.	LED.	-
Luggage compartment lamp.	LED.	-

Note: *We recommend that you have LEDs changed by an authorized dealer.*

Capacities and Specifications

FUEL CONSUMPTION FIGURES - 1.0L ECOBOOST™

NEDC

Urban	Extra-Urban	Combined	CO ₂ Emissions
L/100 km (mpg)	L/100 km (mpg)	L/100 km (mpg)	g/km
6.2–4.8 (46–59)	4.3–3.5 (66–81)	5–4 (56–71)	91–113

WLTP

Low	Medium	High	Extra-High	Combined	CO ₂ Emissions
L/100 km (mpg)	L/100 km (mpg)	L/100 km (mpg)	L/100 km (mpg)	L/100 km (mpg)	g/km
7.5–6.1 (38–46)	5.9–4.6 (48–61)	5.4–4.2 (52–67)	6.8–5.3 (42–53)	6.3–5 (45–56)	112–143

Capacities and Specifications

FUEL CONSUMPTION FIGURES - 1.1L DURATEC

NEDC

Urban	Extra-Urban	Combined	CO ₂ Emissions
L/100 km (mpg)	L/100 km (mpg)	L/100 km (mpg)	g/km
5.6–5.4 (50–52)	4.2–4 (67–71)	4.7–4.5 (60–63)	102–108

WLTP

Low	Medium	High	Extra-High	Combined	CO ₂ Emissions
L/100 km (mpg)	L/100 km (mpg)	L/100 km (mpg)	L/100 km (mpg)	L/100 km (mpg)	g/km
6.8–6.5 (42–43)	5.4–5 (52–56)	5–4.5 (56–63)	6.1–5.7 (46–50)	5.7–5.3 (50–53)	120–129

Capacities and Specifications

FUEL CONSUMPTION FIGURES - 1.5L ECOBOOST™

NEDC

Urban	Extra-Urban	Combined	CO ₂ Emissions
L/100 km (mpg)	L/100 km (mpg)	L/100 km (mpg)	g/km
7.7–7.5 (37–38)	5.1–4.7 (55–60)	6.1–5.7 (46–50)	128–135

WLTP

Low	Medium	High	Extra-High	Combined	CO ₂ Emissions
L/100 km (mpg)	L/100 km (mpg)	L/100 km (mpg)	L/100 km (mpg)	L/100 km (mpg)	g/km
8.7–8.1 (32–35)	6.4–5.7 (44–50)	5.9–5.2 (48–54)	7–6.4 (40–44)	6.8–6.1 (42–46)	139–153

Capacities and Specifications

FUEL CONSUMPTION FIGURES

Fuel Economy and CO2 Emissions

The declared fuel/energy consumptions, CO₂-Emissions and electric range are determined according to the technical requirements and specifications of the European Regulations (EC) 715/2007 and (EU) 2017/1151 as last amended. Light Duty Vehicle type-approved using the World Harmonised Light Vehicle Test Procedure (WLTP) will have Fuel/Energy Consumption and CO₂-Emission information for New European Drive Cycle (NEDC) and WLTP. WLTP will fully replace the NEDC latest by the end of the year 2020. The applied standard test procedures enable comparison between different vehicle types and different manufacturers.

During NEDC phase-out, WLTP fuel consumption and CO₂ emissions are being correlated back to NEDC. There will be some variance to the previous fuel economy and emissions as some elements of the tests have altered, so the same car might have different fuel consumption and CO₂ emissions.

European Directive 1999/94/EC

In addition to the fuel efficiency of a car, driving behaviour as well as other non-technical factors play a role in determining a car's fuel consumption and CO₂ emissions. CO₂ is the main greenhouse gas responsible for global warming. A guide on fuel economy and CO₂ emissions which contains data for all new passenger car models is available at any point of sale free of charge.

Vehicle Identification

VEHICLE IDENTIFICATION NUMBER

Locating the Vehicle Identification Number

You can find the vehicle identification number at the following locations.

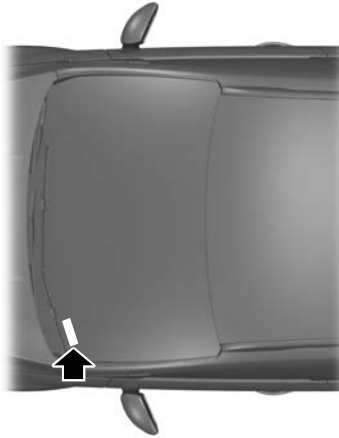

E163915

On the left-hand side of the instrument panel.

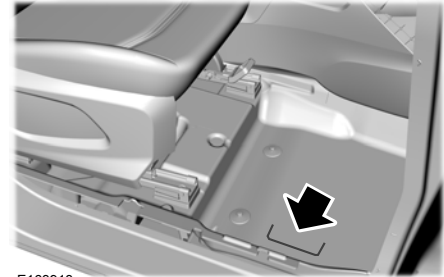

E163913

Stamped into the floor panel on the right-hand side, in front of the front seat.

VEHICLE IDENTIFICATION PLATE

Locating the Vehicle Identification Plate

The vehicle identification plate is within the right-hand door aperture.

Vehicle Identification

Vehicle Identification Plate Overview

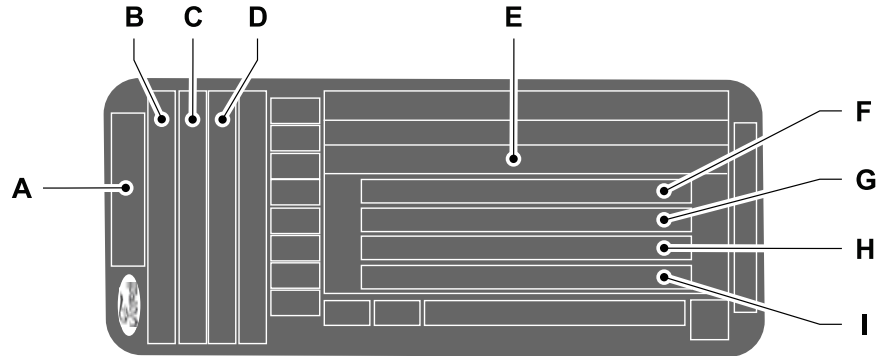

- A Model.
- B Variant.
- C Engine designation.
- D Engine power and emission level.
- E Vehicle identification number.
- F Gross vehicle weight.
- G Gross train weight.
- H Maximum front axle weight.
- I Maximum rear axle weight.

Vehicle Identification

Note: *The vehicle identification plate may vary to that shown.*

Note: *Information on the vehicle identification plate is dependent upon market requirements.*

Connected Vehicle

WHAT IS A CONNECTED VEHICLE

A connected vehicle has technology that allows your vehicle to connect to a mobile network and for you to access a range of features. When used in conjunction with the FordPass app, it could allow you to monitor and control your vehicle further, for example checking the tire pressures, the fuel level and the vehicle location. For additional information, refer to the local Ford website.

CONNECTED VEHICLE REQUIREMENTS

Connected service and related feature functionality requires a compatible vehicle network.

Some remote features require additional service activation. Log in to your Ford account for details. Some restrictions, third party terms and message or data rates may apply.

CONNECTED VEHICLE LIMITATIONS

Evolving technology, cellular networks, or regulations could affect functionality and availability, or continued provision of some features. These changes could even stop some features from functioning.

CONNECTING THE VEHICLE TO A MOBILE NETWORK

What Is the Modem



The modem allows access to a range of features built into your vehicle.

Enabling and Disabling the Modem

1. Press **Settings**.
2. Press **FordPass Connect**.
3. Press **Connectivity settings**.
4. Switch connectivity features on or off.

Connecting FordPass to the Modem

1. Make sure that the modem is enabled using the vehicle settings menu.
2. Open the FordPass app on your device and log in.
3. Add your vehicle or select your vehicle if already added.
4. Select the option for vehicle details.
5. Select the option to activate your vehicle.
6. Make sure that the name on the screen matches the name shown in your FordPass account.
7. Confirm that FordPass account is connected to the modem.

CONNECTING THE VEHICLE TO A WI-FI NETWORK

1. Press **Settings**.
2. Press **Wi-Fi**.
3. Switch **Wi-Fi** on.
4. Press **View available networks**.
5. Select an available Wi-Fi network.

Note: Enter the network password to connect to a secure network.

Connected Vehicle

CONNECTED VEHICLE – TROUBLESHOOTING - VEHICLES WITH: MODEM

Symptom	Possible Cause and Resolution
I cannot confirm the connection of my Ford-Pass account to the modem.	<ul style="list-style-type: none">– Modem is not enabled.<ul style="list-style-type: none">• Switch connectivity features on.– Weak network signal.<ul style="list-style-type: none">• Move your vehicle closer to a place where the network signal is not obstructed.

Connected Vehicle

CONNECTED VEHICLE – TROUBLESHOOTING - VEHICLES WITH: SYNC 3/SYNC 2.5

Symptom	Possible Cause and Resolution
I cannot connect to a Wi-Fi network.	<ul style="list-style-type: none">– Password error.<ul style="list-style-type: none">• Enter the correct network password.– Weak network signal.<ul style="list-style-type: none">• Move your vehicle closer to the Wi-Fi hotspot or to a place where the network signal is not obstructed.– Multiple access points in range with the same SSID.<ul style="list-style-type: none">• Use a unique name for your SSID. Do not use the default name unless it contains a unique identifier, for example as part of the MAC address.
The Wi-Fi connection disconnects after successful connection.	<ul style="list-style-type: none">– Weak network signal.<ul style="list-style-type: none">• Move your vehicle closer to the Wi-Fi hotspot or to a place where the network signal is not obstructed.
I am close to a Wi-Fi hotspot but the network signal strength is weak.	<ul style="list-style-type: none">– Obstructed network signal.<ul style="list-style-type: none">• If your vehicle has a heated windshield, position your vehicle so that the windshield is not facing the Wi-Fi hotspot.• If your vehicle has metallic tinting on the windows but not on the windshield, position your vehicle so that the windshield is facing the Wi-Fi hotspot or open the windows that are facing the hotspot.• If your vehicle has metallic tinting on the windows and the windshield, open the windows that are facing the hotspot.• If your vehicle is in a garage and you have the garage door closed, open the garage door.

Connected Vehicle

Symptom	Possible Cause and Resolution
I cannot see a network in the list of available networks that I expect to see.	<ul style="list-style-type: none"> – Hidden network. <ul style="list-style-type: none"> • Make the network visible and try again.
I cannot see the Wi-Fi hotspot name when I search for Wi-Fi networks on my cell phone or other device.	<ul style="list-style-type: none"> – System limitation. <ul style="list-style-type: none"> • Make sure Wi-Fi hotspot visibility is on. • The system does not provide a Wi-Fi hotspot at this time.
Software downloads take too long.	<ul style="list-style-type: none"> – Weak network signal. <ul style="list-style-type: none"> • Move your vehicle closer to the Wi-Fi hotspot or to a place where the network signal is not obstructed. – Wi-Fi hotspot in high demand or has a slow Internet connection. <ul style="list-style-type: none"> • Use a more reliable Wi-Fi hotspot.
The system seems to connect to a Wi-Fi network and the signal strength is excellent but the software does not update.	<ul style="list-style-type: none"> – No software update available. – Wi-Fi network requires a subscription or acceptance of terms and conditions. <ul style="list-style-type: none"> • Test the connection using another device. If the network requires a subscription or acceptance of terms and conditions, contact the network service provider.

Vehicle Wi-Fi Hotspot

CREATING A VEHICLE WI-FI HOTSPOT

You can create a Wi-Fi hotspot in your vehicle and allow devices to connect to it for access to the Internet.

1. Select **Settings**.
2. Select **FordPass Connect**.
3. Select **Vehicle Hotspot**.

Note: The vehicle hotspot default setting is on.

4. Select **Settings**.
5. Select **Edit**.
6. Select **Wi-Fi visibility**.

Note: The Wi-Fi Visibility default setting is on.

Finding the Wi-Fi Hotspot Name and Password

1. Select **Settings**.
2. Select **FordPass Connect**.
3. Select **Vehicle Hotspot**.
4. Select **Settings**.

Note: The SSID is the hotspot name.

5. Select **View password**.

Connecting a Device to the Wi-Fi Hotspot

1. On your device, turn on Wi-Fi and select the hotspot from the list of available Wi-Fi networks.
2. When prompted, enter the password.

Purchasing a Data Plan

1. Connect a device to the hotspot.

Note: The vehicle network carrier's portal opens on your device.

2. If the portal does not open on your device, open a website and it redirects to the vehicle network carrier's portal.

Note: Secure websites do not redirect.

Note: If you have an active plan, the system does not redirect to the vehicle network carrier's portal when you connect a device. Visit the vehicle network carrier's website to purchase more data.

Note: If data usage information is available in the vehicle hotspot menu, it is approximate.

Note: If you carry out a master reset, the system does not remove your vehicle from your vehicle network carrier's account. To remove your vehicle from the account, contact your vehicle network carrier.

Note: The vehicle network carrier provides Vehicle Hotspot services, subject to your vehicle network carrier agreement, coverage and availability.

CHANGING THE VEHICLE WI-FI HOTSPOT NAME OR PASSWORD

1. Select **Settings**.
2. Select **FordPass Connect**.
3. Select **Vehicle Hotspot**.
4. Select **Settings**.
5. Select **Edit**.
6. Select **Change SSID name**.
7. Enter your required SSID.
8. Select **Done**.
9. Select **Change password**.
10. Enter your required password.
11. Select **Done**.

Audio System

AUDIO UNIT - VEHICLES WITH: SYNC 3

Switching the Audio Unit On and Off



Adjusting the Volume

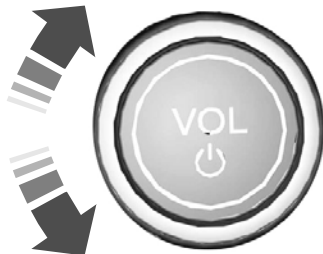

Changing Radio Stations Manual Tuning

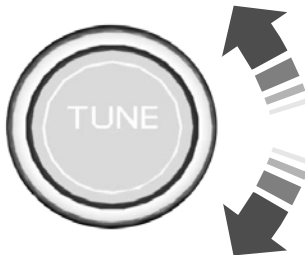

Note: You can change radio stations using the seek buttons.

Note: You can recall radio stations using the preset buttons on the touchscreen.

Seek Up and Next Track Button



Select to skip to the next track.

Press and hold the button to fast forward through the track.

Seek Down and Previous Track Button



Select to return to the beginning of a track.

Repeatedly press the button to return to previous tracks.

Press and hold the button to fast rewind.

Pausing or Playing Media



Select to play a track. Press the button again to pause the track.

In radio mode, press the button to mute the radio. Press the button again to unmute.

Switching the Screen On and Off



Sound Settings



Press the button to adjust the sound settings. You can optimize the sound for different seating positions.

You can also activate and set the sensitivity of the speed compensated volume.

Audio System

AUDIO UNIT - VEHICLES WITH: SYNC 2.5

Switching the Audio Unit On and Off



Adjusting the Volume

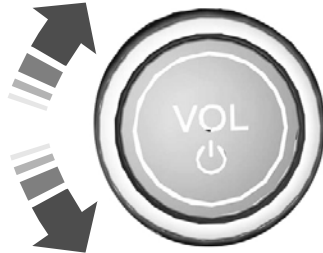

Changing Radio Stations

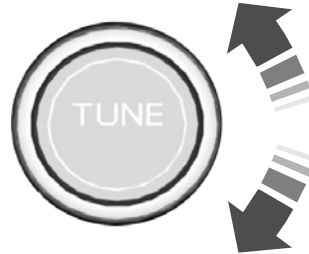

Rotate the control to change radio stations.

Note: You can change the radio frequency by using the seek buttons.

Note: You can recall radio stations using the preset buttons on the touchscreen.

Seek Up and Next Track Button



Select to skip to the next track.

Press and hold the button to fast forward through the track.

Seek Down and Previous Track Button



Select to return to the beginning of a track.

Repeatedly press the button to return to previous tracks.

Press and hold the button to fast rewind.

Pausing or Playing Media



Select to play a track. Press the button again to pause the track.

In radio mode, press the button to mute the radio. Press the button again to unmute.

Switching the Screen On and Off



Sound Settings



Press the button to adjust the sound settings. You can optimize the sound for different seating positions.

You can also activate and set the sensitivity of the speed compensated volume.

Audio System

AM/FM RADIO - VEHICLES WITH: SYNC 2.5

Using the Radio



Select the audio option on the feature bar.

Selecting a Radio Station From a List

1. Select **Sources**.
2. Select **FM**.
3. Select **Stations**.
4. Select a radio station from the list.

Manually Changing Radio Stations

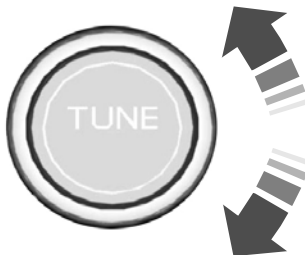

Rotate the control to change radio stations.

Note: You can change the radio frequency by using the seek buttons.

Automatically Changing Radio Stations



Press to seek the next station up the frequency band.

Press and hold to quickly seek up the frequency band.



Press to seek the next station down the frequency band.

Press and hold to quickly seek down the frequency band.

Storing a Radio Station

Press and hold one of the preset buttons on the touchscreen.

Note: The radio briefly mutes to indicate the station has been stored.

DIGITAL RADIO - VEHICLES WITH: SYNC 2.5

Using the Radio



Select the audio option on the feature bar.

Selecting a Radio Station From a List

1. Select **Sources**.
2. Select **DAB**.
3. Select **Stations**.
4. Select a radio station from the list.

Audio System

Manually Changing Radio Stations

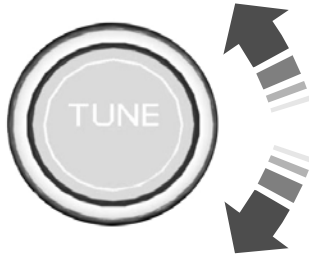

Rotate the control to change radio stations.

Note: You can change the radio frequency by using the seek buttons.

Automatically Changing Radio Stations



Press to seek the next station up the frequency band.

Press and hold to quickly seek up the frequency band.



Press to seek the next station down the frequency band.

Press and hold to quickly seek down the frequency band.

Storing a Radio Station

Press and hold one of the preset buttons on the touchscreen.

Note: The radio briefly mutes to indicate the station has been stored.

AUDIO UNIT CLOCK AND DATE DISPLAYS - VEHICLES WITH: SYNC 2.5



Select the settings option on the feature bar.

1. Select **Clock**.
2. Adjust the clock.

CONNECTING A BLUETOOTH® DEVICE - VEHICLES WITH: SYNC 2.5

Go to the settings menu on your device and switch **Bluetooth®** on.



Select the settings options on the feature bar.

1. Select **Bluetooth**.
2. Switch **Bluetooth®** on.
3. Select **Add a Bluetooth device**.

Note: A prompt alerts you to search for your vehicle on your device.

4. Select your vehicle on your device.

Note: A number appears on your device and on the touchscreen.

5. Confirm that the number on your device matches the number on the touchscreen.

Note: The touchscreen indicates that you have successfully paired your device.

COMPACT DISC PLAYER - VEHICLES WITH: SYNC 2.5

The compact disc player is in the glove compartment.

Compact disc players only play standard 12 cm (4.7 in) discs.

You can play MP3 and WMA discs.

Note: Discs can contain mixed audio file types.

Audio System

Note: Due to technical incompatibility, certain recordable and re-recordable CDs may not function correctly when used in the compact disc player.

Note: You should use a permanent felt tip marker rather than adhesive labels on your homemade CDs.

Using the CD Player



Select the audio option on the feature bar.

1. Select **Sources**.
2. Select **CD**.

Playing a CD



Press the button to play a track. Press the button again to pause the track.



Press the button to skip to the next track.

Press and hold the button to fast forward through the track.



Press the button once to return to the beginning of the track. Press the button repeatedly to return to previous tracks.

Press and hold the button to fast rewind.

STREAMING BLUETOOTH AUDIO - VEHICLES WITH: SYNC 2.5

Check the compatibility of your device on the local Ford website.

Pair your device. See **Connecting a Bluetooth® Device** (page 407).



Select the audio option on the feature bar.

Select **Sources**.



Select the **Bluetooth®** option.



Press the button to play the track. Press the button again to pause the track.



Press the button to skip to the next track.

Press and hold the button to fast forward through the track.



Press the button once to return to the beginning of the track. Repeatedly press the button to return to previous tracks.

Press and hold the button to fast rewind.

PLAYING MEDIA FROM A USB DEVICE - VEHICLES WITH: SYNC 2.5

Supported File Formats

The system supports the following file formats:

- MP3, M4A, M4B, WMA, WAV, AAC, FLAC, APE and AIFF audio file formats.
- ext2, exFAT, FAT, FAT32, NTFS and HFS+ file systems.

Selecting the USB Device

Connect your device to the USB port.



Select the audio option on the feature bar.

Select **Sources**.



Select the USB option.

Audio System

Playing from the USB Device



Press the button to play a track. Press the button again to pause the track.



Press the button to skip to the next track.

Press and hold the button to fast forward through the track.



Press the button once to return to the beginning of a track. Repeatedly press the button to return to previous tracks.

Press and hold the button to fast rewind through the track.

Sorting by Categories

You can also sort and play music by specific categories, for example artist or album.

USB PORT

USB ports may be in the following locations:

- On the instrument panel behind the audio unit display.
- On the instrument panel below the climate control. See **Visual Search** (page 27).
- In the center console.

You can use the USB port to charge a device only when the engine is running.

APPS - VEHICLES WITH: SYNC 2.5

Note: We recommend that you check your data plan before using your apps through the system. Using them could result in additional charges.

Note: We recommend that you check the app provider's terms and conditions and privacy policy before using their app.

Note: Make sure that you have an active account for apps that you want to use through the system.

Note: Some apps will work with no setup. Others require you to configure some personal settings before you can use them.

Using Apple CarPlay

Switching Apple CarPlay On

1. Connect your device to a USB port.
2. Follow the instructions on the touchscreen.

Note: Certain features of the system are not available when you are using Apple CarPlay.

Switching Apple CarPlay Off



Select the settings option on the feature bar.

1. Select **Apple CarPlay preferences**.
2. Disable Apple CarPlay.

Using Apps on an iOS Device

Note: For more information about available apps, refer to the local Ford website.

When you start an app through the system for the first time, you could be asked to grant certain permissions. You can review and change the permissions that you have granted at any time when your vehicle is not moving.



Select the apps option on the feature bar.

Audio System

1. Switch Apple CarPlay off.
2. Connect your device to a USB port.
3. Start the apps on your device that you want to use through the system.

Note: *If you close the apps on your device, you will not be able to use them through the system.*

4. Select **Find mobile apps**.

Note: *The system searches and connects to compatible apps that are running on your device.*

5. Select the app that you want to use on the touchscreen.

Using Android Auto

Switching Android Auto On

1. Connect your device to a USB port.
2. Follow the instructions on the touchscreen.

Note: *You might need to enable Android Auto from the settings menu.*

Note: *Certain features of the system are not available when you are using Android Auto.*

Switching Android Auto Off



Select the settings option on the feature bar.

1. Select **Android Auto preferences**.
2. Disable Android Auto.

Using Apps on an Android Device

Note: *For more information about available apps, refer to the local Ford website.*

When you start an app through the system for the first time, you could be asked to grant certain permissions. You can review and change the permissions that you have granted at any time when your vehicle is not moving.



Select the apps option on the feature bar.

1. Switch Android Auto off.
2. Pair your device.
3. Start the apps on your device that you want to use through the system.

Note: *If you close the apps on your device, you will not be able to use them through the system.*

4. Select **Find mobile apps**.

Note: *The system searches and connects to compatible apps that are running on your device.*

5. Select the app that you want to use on the touchscreen.

Audio System

Apps Troubleshooting

Symptom	Possible Cause and Resolution
The system cannot find any apps.	<ul style="list-style-type: none">– Incompatible device.<ul style="list-style-type: none">• You will need an Android device with OS 2.3 or higher or an iOS 3GS device with iOS 5.0 or higher. Pair and connect your Android device to find AppLink compatible apps. Connect your iOS device to a USB port to find AppLink compatible apps.
I have a compatible device and it is correctly connected but the system still cannot find any apps.	<ul style="list-style-type: none">– AppLink compatible apps not installed on your device.<ul style="list-style-type: none">• Download and install the latest version of the app.– AppLink compatible apps not running on your device.<ul style="list-style-type: none">• Start the apps to allow the system to find them and make sure you sign in to any apps if required.– Incorrect app settings.<ul style="list-style-type: none">• Check and adjust the app settings on your device and allow the system to access the app if required.
I have a compatible device, it is correctly connected and my apps are running but the system still cannot find any apps.	<ul style="list-style-type: none">– Apps failed to fully close.<ul style="list-style-type: none">• Restart the apps and try again.
I have an Android device that is correctly connected, I have restarted my apps and they are running but the system still cannot find them.	<ul style="list-style-type: none">– An issue on some older versions of the Android operating system could result in apps not being found.<ul style="list-style-type: none">• Switch Bluetooth® off and on again to force the system to reconnect to your device.

Audio System

Symptom	Possible Cause and Resolution
I have an iOS device that is correctly connected, I have restarted my apps and they are running but the system still cannot find them.	<ul style="list-style-type: none"> – Cable connection issue. <ul style="list-style-type: none"> • Disconnect the cable from your device, wait for a moment and then connect it again to force the system to reconnect to your device.
I have an Android device running a media app which the system has found but I cannot hear the sound or the sound is very quiet.	<ul style="list-style-type: none"> – Device volume is low. <ul style="list-style-type: none"> • Turn the volume up on your device.
I have an Android device running a number of compatible apps but the system cannot find all of them.	<ul style="list-style-type: none"> – Device limitation. Some Android devices have a limited number of Bluetooth® ports that apps can use to connect. If you have more apps running on your device than the number of available Bluetooth® ports, the system cannot find all of them. <ul style="list-style-type: none"> • Close some of the apps to allow the system to find those that you want to use.

USING VOICE RECOGNITION

Phone Voice Service

This system allows you to use the voice recognition features of your phone and focus on your driving.



Press the voice control button on the steering wheel.

Note: This only works when connected via **Bluetooth®**. See **Connecting a Bluetooth® Device** (page 407).

Note: When using voice recognition use the language set on the device.

Note: We recommend that you check your data plan before using your phone voice service through the system. Using them could result in additional charges.

Audio System

AUDIO SYSTEM – TROUBLESHOOTING - VEHICLES WITH: SYNC 2.5

Symptom	Possible Cause and Resolution
The system is not functioning.	<ul style="list-style-type: none">You can reset the system to restore functionality that has stopped working.<ul style="list-style-type: none">The system reset is designed to restore functionality and does not delete any personal data that you have stored.
I want to delete personal data from the system.	<ul style="list-style-type: none">A master reset is required to restore the system back to factory settings.<ul style="list-style-type: none">This deletes any personal data that you have stored.
The system is not up to date.	<ul style="list-style-type: none">The latest version has not been installed.<ul style="list-style-type: none">You can download the latest version or set the system to automatically update.

Resetting the System

1. Simultaneously press and hold the seek up and the audio unit power buttons until the screen goes black.
2. Wait three minutes to allow the system to complete the reset.

Updating the System

Note: We may need to update operating system software on your vehicle, including security updates and bug fixes, to keep connected services current, like Vehicle Hotspot, without prior notice to you.

Updating the System Using a USB Drive

Downloading an Update

1. Go to the system update page on the local Ford website.
2. Download the update.

Note: The website notifies you if an update is available.

3. Insert a USB drive into your computer.

Note: The USB drive needs to be empty and meet the minimum requirements detailed on the website.

4. Follow the instructions provided to download the update to the USB drive.

Installing an Update

Note: You can use the system when an installation is in progress.

1. Disconnect all other USB devices from the USB ports.
2. Connect the USB drive with the update to a USB port.

Note: Installation starts automatically within 10 minutes.

Audio System

Updating the System Using a Wi-Fi Network Connection

Connecting to a Wi-Fi Network



Select the settings option on the feature bar.

1. Select **Wi-Fi**.
2. Select **View available networks**.
3. Select an available network.

Note: Enter the network password to connect to a secure network.

Switching Automatic System Updates On



Select the settings option on the feature bar.

1. Select **Automatic updates**.
2. Switch automatic system updates on.

The system is now set to check for and receive system updates when it is connected to a Wi-Fi network.

Note: You can use the system when a download is in progress.

Note: If the system is disconnected from the Wi-Fi network when a download is in progress, the download continues the next time the system is connected to a Wi-Fi network.

Master Reset



Select the settings option on the feature bar.

1. Select **General**.
2. Select **Master reset**.
3. Select **Continue**.

Note: If you carry out a master reset, the system does not remove your vehicle from your vehicle network carrier's account. To remove your vehicle from the account, contact your vehicle network carrier.

Note: If you carry out a master reset, the system removes any authorized users and personal data.

GENERAL INFORMATION



WARNING: Driving while distracted can result in loss of vehicle control, crash and injury. We strongly recommend that you use extreme caution when using any device that may take your focus off the road. Your primary responsibility is the safe operation of your vehicle. We recommend against the use of any hand-held device while driving and encourage the use of voice-operated systems when possible. Make sure you are aware of all applicable local laws that may affect the use of electronic devices while driving.

About SYNC

The system allows you to interact with the entertainment, information and communication systems on your vehicle using voice commands and a touchscreen. The system provides easy interaction with audio, phone, navigation, mobile apps and settings.

Note: You can switch the system on and use it for up to an hour without switching the ignition on.

Note: You can use the system after you switch the ignition off for up to 10 minutes or until you open a door.

Note: For your safety, some features are speed-dependent. Their use is limited to when your vehicle speed is less than 5 km/h (3 mph).

Using the Touchscreen

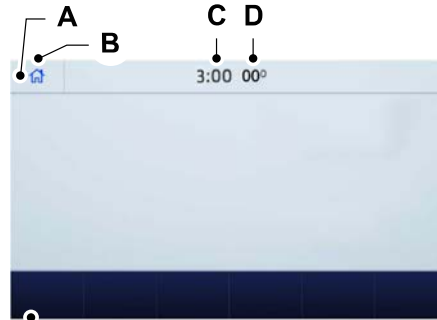

- A Status bar.
- B Home screen.
- C Clock. See **Settings** (page 438).

- D Outside air temperature.
- E Feature bar.

Status Bar

-  Cell phone microphone muted.
-  Audio system muted.
-  Software update installed.
-  Wi-Fi connected.
-  Cell phone roaming.
-  Text message received.
-  Emergency Assistance off.
-  Cell phone network signal strength.

SYNC™ 3



Vehicle data sharing on.



Vehicle location sharing on.



Vehicle data and vehicle location sharing on.



Traffic data source: Live traffic.



Traffic data source: Traffic broadcast.



Wireless charger active.

Feature Bar



Select to use the radio, a USB, a media player or a Bluetooth device. See **Entertainment** (page 425).



Select to adjust climate settings. See **Climate** (page 427).



Select to make calls and access the phonebook on your cell phone. See **Phone** (page 430).



Select to use the navigation system. See **Navigation** (page 432).



Select to search for and use compatible apps on your iOS or Android device. See **Apps** (page 437).



Select to adjust system settings. See **Settings** (page 438).

Cleaning the Touchscreen

See **Cleaning Displays and Screens** (page 336).

Updating the System

Updating the System Using a USB Drive

Downloading an Update

1. Go to the SYNC update page on the local Ford website.
2. Download the update.

Note: *The website notifies you if an update is available.*

3. Insert a USB drive into your computer.

Note: *The USB drive needs to be empty and meet the minimum requirements detailed on the website.*

4. Follow the instructions provided to download the update to the USB drive.

Installing an Update

Note: *You can use the system when installation is in progress.*

1. Disconnect all other USB devices from the USB ports.
2. Connect the USB drive with the update to a USB port.

Note: *Installation starts automatically within 10 minutes.*

Updating the System Using a Wi-Fi Network Connection

Switching Automatic System Updates On

1. Select **Settings**.
2. Select **Automatic updates**.
3. Switch **Automatic system updates** on.

The system is now set to check for and receive system updates when it is connected to a Wi-Fi network.

Note: *You can use the system when download is in progress.*

SYNC™ 3

Note: If the system is disconnected from the Wi-Fi network when download is in progress, the download continues the next time the system is connected to a Wi-Fi network.

Connecting to a Wi-Fi Network

See **Connecting the Vehicle to a Wi-Fi Network** (page 399).

Additional Information and Assistance

For additional information and assistance, we recommend that you contact an authorized dealer or refer to the local Ford website.

General

USING VOICE RECOGNITION

The system allows you to interact with the entertainment, information and communication systems on your vehicle using voice commands. This allows you to keep your hands on the steering wheel and focus on what is in front of you.



Press the voice control button on the steering wheel and wait for the voice prompt.

Note: Press the voice control button again to interrupt a voice prompt and begin speaking.

Note: Turn the volume control when a voice prompt plays to adjust the volume.

Note: Press and hold the voice control button on the steering wheel to use Siri on your iOS device.

The following voice commands are designed to help you from any screen:

- **List of commands**
- **Help**

The following tables list some of the more frequently used voice commands. For a complete list of voice commands, refer to the local Ford website.

Voice Command	Description
___ list of commands	Get a list of voice commands for a specific feature. ¹
Cancel	Cancel an active voice session.
___ help	Get a list of voice commands for a specific feature. ¹
Back	Return to the previous screen.
Main menu	Go to the main menu.

SYNC™ 3

Voice Command	Description
Next page	Go to the next page.
Previous page	Go to the previous page.

¹ Add the name of the feature to the command.

Entertainment

Audio Source

Voice Command	Description
Radio	Use the radio.
CD Player	Use the CD player.
Bluetooth audio	Use a Bluetooth device.
USB	Use a USB or media player.

Radio

Voice Command	Description
AM	Listen to AM radio.
___ AM	Tune to a specific AM frequency. ¹
DAB	Listen to DAB radio.

SYNC™ 3

Voice Command	Description
FM	Listen to FM radio.
___ FM	Tune to a specific FM frequency. ¹

¹Add the radio frequency to two decimal places to the command.

USB and Media Player

Voice Command	Description
Play album ___	Play your music by category. ¹
Play artist ___	
Play audiobook ___	
Play genre ___	
Play playlist ___	
Play podcast ___	
Play song ___	Browse music on a USB device.
Browse all albums	
Browse all artists	
Browse all audiobooks	
Browse all genres	

SYNC™ 3

Voice Command	Description
Browse all playlists	
Browse all podcasts	
Browse all tracks	
Browse album ____	Browse your music by category on a USB device. ¹
Browse artist ____	
Browse audiobook ____	
Browse genre ____	
Browse playlist ____	
Browse podcast ____	

¹Add an album name, artist name, audiobook name, genre name, playlist name, podcast name or track name to the command. Say the name exactly as it appears on your device.

Phone

Voice Command	Description
Pair phone	Pair a cell phone or Bluetooth enabled device.
Redial	Redial the last number that you dialed.
Dial ____	Dial a number. ¹

SYNC™ 3

Voice Command	Description
Call ____	Call a specific contact from your phonebook. ²
Call ____ ____	Call a specific contact from your phonebook at a specific location. ³
Listen to message	Listen to a text message.
Listen to message ____	Listen to a specific text message from a list of text messages.
Reply to message	Reply to the last text message.

¹Add the number you want to dial to the command.

²Add a contact name from your phonebook to the command. Say the first and last name of your contact exactly as it appears on your device.

³Add a contact name and location from your phonebook to the command. Say the first and last name of your contact exactly as it appears on your device.

SYNC™ 3

Navigation (If Equipped)

Setting a Destination

Voice Command	Description
Find an address	Enter a destination address. When prompted, provide the house number, the street and city.
Find a POI	Search for a point of interest by name or by category.
Find nearest ___	Search for a nearby point of interest by category. ¹
Find a POI category	Search for a point of interest category. ¹
Destination home	Set your saved home address as your destination.
Destination work	Set your saved place of work as your destination.
Previous destinations	Display and select from a list of previous destinations.
Favourite destinations	Display and select from a list of favorite destinations.

¹ Add a point of interest category or the name of a major brand or chain to the command.

SYNC™ 3

Route Guidance

Voice Command	Description
Cancel route	Cancel the current route.
Reroute	Select an alternate route.
Repeat last instruction	Repeat the last guidance prompt.
Show route	Display an overview of the route.
Show map	Display the map on the touchscreen.
Show north up	Display a two-dimensional map with north toward the top of the touchscreen.
Show heading up	Display a two-dimensional map with the direction you are traveling toward the top of the touchscreen.
Show 3D	Display a three-dimensional map with the direction you are traveling toward the front.

Apps

General

Voice Command	Description
Mobile apps	Start an app. The system prompts your for the app name.
List apps	Get a list of apps running on your device.
Find apps	Search and connect to apps running on your device.

SYNC™ 3

Active App

Voice Command	Description
___ help	Get a list of voice commands for a specific app. ¹
Close ___	Close an app. ¹

¹ Add an app name to the command.

Voice Settings

Voice Command	Description
Voice settings	Go to the voice settings menu.
Interaction mode standard	Switch long voice prompts on.
Interaction mode advanced	Switch short voice prompts on.
Call confirmation on	Switch call confirmation on. The system prompts you to confirm before making a call.
Call confirmation off	Switch call confirmation off. The system does not prompt you to confirm before making a call.
Voice command lists on	Switch the display of voice commands on.
Voice command lists off	Switch the display of voice commands off.

Automatic Blower Motor Speed Reduction

If necessary, the system decreases the blower motor speed when you are using voice commands to reduce the amount of background noise in your vehicle. It returns to normal when you are finished.

Switching Automatic Blower Motor Speed Reduction Off

Simultaneously press the **A/C** and recirculated air buttons.

ENTERTAINMENT



Select the audio option on the feature bar.

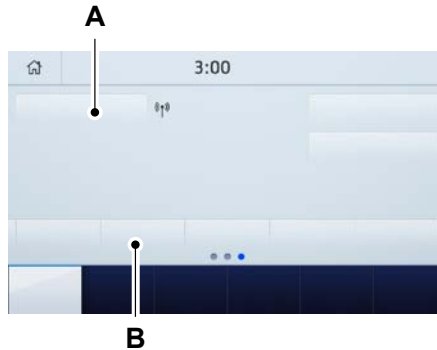

- A Audio source. Select to choose a different audio source.
- B Presets. Swipe left to view more presets.

You can access these options using the touchscreen or voice commands.

Using the Radio

Setting an AM/FM Radio Station

1. Select **Sources**.
2. Select **AM** or **FM**.

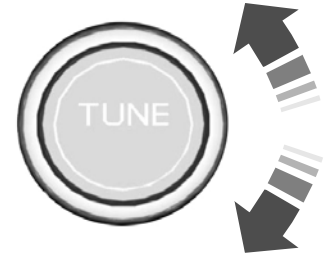

3. Rotate the control to change the frequency.

Selecting a FM Radio Station From a List

1. Select **Sources**.
2. Select **FM**.
3. Select **Stations**.
4. Select a radio station from the list.

Selecting a Digital Radio Station From a List

1. Select **Sources**.
2. Select **DAB**.

3. Select **Stations**.
4. Select an ensemble.
5. Select a radio station from the list.

Manually Changing Digital Radio Stations

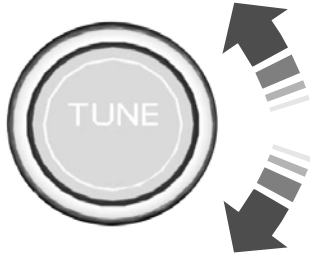

Rotate the control to change the station.

Automatically Changing Radio Stations



Press to seek the next station up the frequency band.

Press and hold to quickly seek up the frequency band.



Press to seek the next station down the frequency band.

Press and hold to quickly seek down the frequency band.

Storing a Radio Station

Press and hold one of the preset buttons.

Note: *The radio briefly mutes to indicate the station has been stored.*

Note: *You can add additional preset pages using the settings option on the feature bar.*

Switching Traffic Announcements On

Select **Traffic (TA)**.

Note: *If you switch traffic announcements on, traffic announcements broadcast by radio stations interrupt the current audio source to help you plan your route.*

Streaming Music From a Bluetooth Device

Check the compatibility of your device on the local Ford website.

Pair your device. See **Phone** (page 430).

Select **Sources**.



Select Bluetooth.

Searching for Tracks on a Bluetooth Device

Select **Browse**.

Select a track.

Note: *Select the cover art to view information about the current track.*

Playing Tracks on a Bluetooth Device in a Random Order



Select to play tracks in a random order.

Repeating Tracks on a Bluetooth Device



Select the repeat icon to repeat tracks.

Note: *You can repeat one track or all tracks on an audio format Bluetooth device. You can repeat one track, all tracks or all tracks in one folder on a Bluetooth device.*

Note: *A small number one appears next to the repeat icon to indicate that a track is set to repeat. A small folder icon appears next to it to indicate that a folder is set to repeat.*

Playing Music From a USB or Media Player

Connect your device to a USB port.

Select **Sources**.



Select USB.

Note: The system indexes your music before you can play it.

Searching for Tracks on a USB or Media Player

Select **Browse**.

Select a track.

Note: Select the cover art to view information about the current track.

Note: You can also browse by album, artist, audiobook, genre, playlist, podcast or track name.

Playing Tracks on a USB or Media Player in a Random Order



Select to play tracks in a random order.

Repeating Tracks on a USB or Media Player



Select the repeat icon to repeat tracks.

Note: You can repeat one track or all tracks on an audio format USB or media player. You can repeat one track, all tracks or all tracks in one folder on a USB or media player.

Note: A small number one appears next to the repeat icon to indicate that a track is set to repeat. A small folder icon appears next to it to indicate that a folder is set to repeat.

Supported Devices

The system supports most USB and media players, including iOS and Android devices.

Supported File Formats

The system supports the following file formats:

- MP3, MP4, WMA, WAV, AAC, AIFF, APE, DSD, and FLAC audio file formats.
- MP3, WMA, WAV, M4A, M4B, AAC, and FLAC file extensions.
- FAT, exFAT, and NTFS file systems.

Audio File Metadata

The system organizes files on your USB or media player by metadata tags. Metadata tags contain information about the file. If the metadata tags for the files on your USB or media player contain no information, the system classifies them as unknown. The system can index up to 50000 tracks on a USB device or media player, and up to 10 devices.

CLIMATE

Touch the climate button on the touchscreen to access your climate control features.

Note: You can switch temperature units between Fahrenheit and Celsius. See **Settings** (page 438).

Accessing the Climate Control Menu



Touch the button to access additional controls for the front climate system.

Directing the Airflow



Touch the button to direct airflow to the windshield air vents and de-mister.

SYNC™ 3



Touch the button to direct airflow to the instrument panel air vents.



Touch the button to direct airflow to the footwell air vents.

You can direct air through any combination of these air vents.

Setting the Blower Motor Speed



Touch up or down to increase or decrease the volume of air that circulates in your vehicle.

Setting the Temperature

Touch up or down on the left-hand temperature control to set the left-hand temperature.

Note: *This control also adjusts the right-hand side temperature when you switch off dual zone mode.*

Touch up or down on the right-hand temperature control to set the right-hand temperature.

Switching Auto Mode On and Off



Touch the button to switch on automatic operation, then set the temperature.

The system adjusts the blower motor speed, air distribution, air conditioning operation, and outside or recirculated air to reach and maintain the temperature you have set.

Switching the Air Conditioning On and Off



A pop-up appears on the screen to display the air conditioning options.

MAX A/C: Touch the button to activate and maximize cooling. The driver and passenger temperatures are set to LO, recirculated air flows through the instrument panel vents, air conditioning automatically turns on and the fan automatically adjusts to the highest speed.

A/C: Touch to switch the air conditioning on or off. Use A/C with recirculated air to improve cooling performance and efficiency.

Note: *In certain conditions, such as maximum defrost, the air conditioning compressor may continue to operate even though you switch off the air conditioning.*

Switching the Climate Control On and Off



Touch the button.

Switching the Climate Controlled Seats On and Off



Touch the button to cycle through the various climate controlled seat settings.

Switching Dual Zone Mode On and Off



Touch the button to switch on temperature control for the right-hand side of the vehicle.

Switching the Heated Exterior Mirrors On and Off



Touch the button.

Switching the Heated Windshield On and Off



Touch the button to clear the windshield of thin ice and fog. The heated windshield turns off after a short period of time.

Switching the Heated Rear Window On and Off



Touch the button to clear the rear window of thin ice and fog.

Switching the Heated Seats On and Off



Touch the button to cycle through the various heat settings.

Switching the Heated Steering Wheel On and Off



Touch the button.

Switching Maximum Air Conditioning On and Off



Touch the button for maximum cooling.

Recirculated air flows through the instrument panel air vents, air conditioning turns on and the blower motor adjusts to the highest speed.

Switching Maximum Defrost On and Off



Touch the button for maximum defrosting.

Air flows through the windshield air vents, and the blower motor adjusts to the highest speed.

You can also use this setting to defog and clear the windshield of a thin covering of ice.

Note: *To prevent window fogging, you cannot select recirculated air when maximum defrost is on.*

Note: *The heated rear window also turns on when you select maximum defrost.*

Switching Recirculated Air On and Off



Touch the button to switch between outside air and recirculated air.

The air currently in the passenger compartment recirculates. This may reduce the time needed to cool the interior, when used with **A/C**, and reduce unwanted odors from entering your vehicle.

Note: *Recirculated air may turn off, or prevent you from switching on, in all air flow modes except **MAX A/C** to reduce the risk of fogging. Recirculation may also turn on and off in various air distribution control combinations during hot weather to improve cooling efficiency.*

Switching the Ventilated Seats On and Off



Touch the button to cycle through the various ventilated seat settings.

Accessing Rear Climate Controls



Touch the button to access additional controls for the rear climate system.

Rear Climate Control Lock Indicator



Touch the button.

When on, you can only operate the rear passenger settings through the front controls.

Switching Rear Auto Mode On and Off



Touch the button to switch on rear automatic operation, then set the temperature.

Switching the Rear Climate Controlled Seats On and Off



Touch the button to cycle through the various climate controlled seat settings.

Switching the Rear Heated Seats On and Off



Touch the button to cycle through the various heat settings.

Switching the Rear Ventilated Seats On and Off



Touch the button to cycle through the various ventilated seat settings.

PHONE



WARNING: Driving while distracted can result in loss of vehicle control, crash and injury. We strongly recommend that you use extreme caution when using any device that may take your focus off the road. Your primary responsibility is the safe operation of your vehicle. We recommend against the use of any hand-held device while driving and encourage the use of voice-operated systems when possible. Make sure you are aware of all applicable local laws that may affect the use of electronic devices while driving.

Check the compatibility of your device on the local Ford website.

Pairing Your Cell Phone for the First Time

Go to the settings menu on your cell phone and switch Bluetooth on. Make sure your cell phone is discoverable. See your cell phone's user manual.



Select the phone option on the feature bar.

1. Select **Pair phone**.

Note: A prompt alerts you to search for your vehicle on your cell phone.

2. Select your vehicle on your cell phone.

Note: A number appears on your cell phone and on the touchscreen.

3. Confirm that the number on your cell phone matches the number on the touchscreen.

Note: The touchscreen indicates that you have successfully paired your cell phone.

4. Download the phonebook from your cell phone when you are prompted.

Note: If you pair more than one cell phone, use the phone settings to specify the primary phone. You can change this setting at any time.

Using Your Cell Phone

Recent Call list

Display and select an entry from a list of previous calls.

Contacts

Display a smart search form to look up your contacts. Use the List button to alphabetically sort your contacts.

Your phone

Change ring tones, alerts or pair another cell phone.

Change device

Display the list of paired or connected devices that you can select.

Do not disturb

Reject incoming calls and switch ring tones and alerts off.

Phone Keypad

Directly dial a number.

Text messages

Display the cell phone messages.

Siri

Connect to Siri on your iOS device.

Phone Voice Assistant

Connect to the phone voice service on your Android device.

Text Messaging

Setting Text Message Notification

iOS

1. Go to the settings menu on your cell phone.
2. Select Bluetooth.
3. Select the information icon to the right of your vehicle.
4. Switch text message notification on.

Android

1. Go to the settings menu on your cell phone.
2. Select Bluetooth.
3. Select the profiles option.
4. Select the phone profile.
5. Switch text message notification on.

Using Text Messaging

Menu Item	Description
Hear it	Hear the text message.
View	View the text message.
Call	Call the sender.
Reply	Reply to the text message with a standard text message.

Apple CarPlay

1. Connect your device to a USB port.
2. Follow the instructions on the touchscreen.

Note: Certain features of the system are not available when you are using Apple CarPlay.

Switching Apple CarPlay Off

1. Select **Settings**.
2. Select **Apple CarPlay preferences**.
3. Switch **Apple CarPlay** off.

Android Auto

1. Connect your device to a USB port.
2. Follow the instructions on the touchscreen.

Note: You might need to enable Android Auto from the settings menu.

Note: Certain features of the system are not available when you are using Android Auto.

Switching Android Auto Off

1. Select **Settings**.
2. Select **Android Auto**.
3. Switch **Android Auto** off.

NAVIGATION

Note: For more information, refer to the local Ford website.



Select the navigation option on the feature bar.



D

- A Map view menu.
- B Zoom out.

- C Zoom in.
- D Route guidance menu.
- E Destination entry menu.

Setting a Destination

Setting a Destination Using the Text Entry Screen

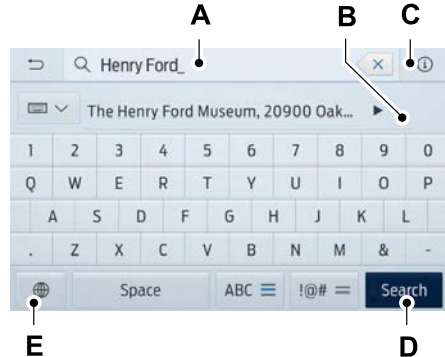

- A Text entry field.
- B Automatic suggestions based on the text you enter.

- C Information icon.
- D Search.
- E Keyboard settings.

Note: Select one of the suggestions to copy the detail to the text entry field.

Note: You can enter a destination in a number of formats, **city street number**, **city number street**, **zip code** or **point of interest**.

Note: You do not have to enter the destination country.

Note: To enter mutated vowels or accented characters, for example **ã** or **é**, press and hold the corresponding character on the keyboard.

Select **Search**.

Select **Start** to begin route guidance.

Setting a Destination Using the Map Screen

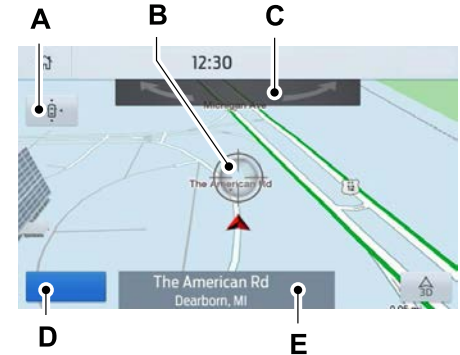

- A Re-center the map.
- B Selected location.
- C 3D map rotation. Swipe left or right.
- D Start route guidance.
- E Destination name.

Select the location on the map.

Select **Start** to begin route guidance.

Changing the Format of the Map

Display the map in one of the following formats:

- A two-dimensional map with the direction you are traveling toward the top of the screen.
- A two-dimensional map with north toward the top of the screen.
- A three-dimensional map with the direction you are traveling toward the front.

Zoom

Display more or less detail on the map.

Note: You can use pinch gestures to zoom in and out. Place two fingers on the screen and move them apart to zoom in. Place two fingers on the screen and bring them together to zoom out.

Route Guidance

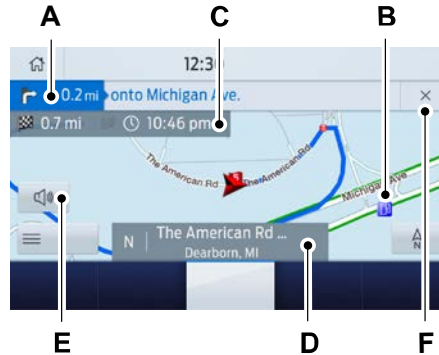

- A Turn indicator. Select to hear the last guidance prompt.
- B Point of interest.

- C Estimated time of arrival, distance to destination or time to destination.
- D Current road.
- E Mute guidance prompts.
- F Cancel route guidance.

Note: To change guidance prompt volume, turn the volume control when a guidance prompt plays.

SYNC™ 3

Route Guidance Menu

Menu Item	Description
Screen view	Adjust your map preferences for when route guidance is active.
Full map	View a full screen map when route guidance is active.
Motorway exit info	View exit information for your current route.
Turn list	View the turn list for your current route. Select a road to avoid it.
Traffic list	View traffic nearby or on your current route. ¹
Navigation settings	Adjust navigation settings.
Where am I?	View information about your current location.
Cancel route	Cancel route guidance.
Show route	View the entire current route on the map.
Re-route	View an alternative route compared to your current one.
Edit waypoints	Change the order or remove waypoints.
Optimise order	The system determines the order of waypoints for you.
Start	Go to the next screen and start the new route.
Search	Enter a destination address.
Home	Set your saved home address as your destination
Work	Set your saved place of work as your destination.

SYNC™ 3

Menu Item	Description
Favourites	Display and select from a list of favorite destinations.
Previous destinations	Display and select from a list of previous destinations.
POI	Display the point of interest categories.

¹ Reliant upon traffic message channel or live traffic.

Adjusting the Guidance Prompt Volume

Turn the volume control when a guidance prompt plays to adjust the volume.

Note: *If you have inadvertently adjusted the volume to zero, press the turn indicator button to play the last voice prompt and then adjust the volume to the desired level.*

Muting Guidance Prompts



Select the mute option on the screen to mute guidance prompts.

Note: *The system mutes the next and all future guidance prompts.*

Adding Waypoints

You can add a waypoint to a navigation route as a destination along your route. You can add up to five waypoints.

1. Select the search option on the map.

2. Set a destination.
3. Select the flag icon.
4. Select **Start**.

Canceling Route Guidance

Canceling Route Guidance From the Route Guidance Menu



Select the route guidance menu option on the active guidance screen.

Select **Cancel route**.

Canceling Route Guidance From the Main Map



Select the icon in the upper right-hand corner of the main map to cancel route guidance.

Live Traffic (If Equipped)

Live traffic provides near real-time traffic information to help you plan the fastest route to your destination. You must have an active subscription for Live Traffic.

SYNC™ 3

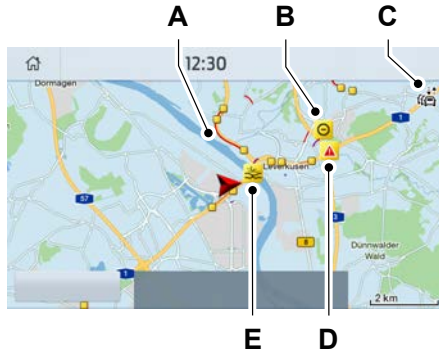

- A Traffic congestion.
- B Road closure.
- C Live traffic active.
- D Urgent warning.
- E Traffic incident.

Switching Live Traffic On

Note: Make sure that the modem is enabled. See **Connected Vehicle** (page 399).

1. Select **Settings**.
2. Select **FordPass Connect**.

3. Select **Connectivity settings**.
4. Switch **Vehicle connectivity** on.
5. Switch **Location** on.
6. Switch **Vehicle data & Remote ctrl** on.
7. Switch **Live Traffic** on.

Navigation Map Updates

Please check the local Ford website or contact your dealership for navigation map updates.

HERE is the digital map provider for the navigation application. If you find map data errors, you can report them directly to HERE by visiting www.here.com. HERE evaluates all reported map errors and responds with the result of their investigation by e-mail.

APPS

Note: For more information about available apps, supported devices and troubleshooting, refer to our local website.

When you start an app through the system for the first time, you could be asked to grant certain permissions. You can review and change the permissions that you have granted at any time when your vehicle is not moving. See **Settings** (page 438).

Note: We recommend that you check your data plan before using your apps through the system. Using them could result in additional charges.

Note: We recommend that you check the app provider's terms and conditions and privacy policy before using their app.

Note: Make sure that you have an active account for apps that you want to use through the system.

Note: Some apps will work with no setup. Others require you to configure some personal settings before you can use them.

Using Apps on an iOS Device



Select the apps option on the feature bar.

1. If your device is connected via USB, switch Apple CarPlay off. See **Phone** (page 430).
2. Connect your device to a USB port or pair and connect using Bluetooth.
3. If prompted to enable CarPlay, select **Disable**.
4. Start the apps on your device that you want to use through SYNC.

Note: If you close the apps on your device, you will not be able to use them through the system.

5. Select the app that you want to use on the touchscreen.

Note: Connect your device to a USB port if you want to use a navigation app. When using a navigation app, keep your device unlocked and the app open.

Using Apps on an Android Device



Select the apps option on the feature bar.

1. If your device is connected via USB, switch Android Auto off. See **Phone** (page 430).
2. Switch on **Enable Mobile apps via USB** in the Mobile Apps Settings tile.
3. Pair your device. See **Phone** (page 430).
4. Start the apps on your device that you want to use through SYNC.

Note: If you close the apps on your device, you will not be able to use them through the system.

5. Select **Find mobile apps**.

Note: The system searches and connects to compatible apps that are running on your device.

6. Select the app that you want to use on the touchscreen.

Note: Mobile Apps on your device use the USB port to establish a connection with SYNC. Some devices may lose the ability to play music over USB when Mobile Apps are enabled.

Using Mobile Navigation on an Android Device

1. Connect your device to a USB port.
2. Switch Android Auto off. See **Phone** (page 430).
3. Switch on **Enable Mobile apps via USB** in the Mobile Apps Settings tile.
4. Select the apps option on the feature bar.
5. Select the navigation app that you want to use on the touchscreen.

Note: When using a navigation app, keep your device unlocked and the app open.

Note: Mobile Apps on your device use the USB port to establish a connection with SYNC. Some devices may lose the ability to play music over USB when Mobile Apps are enabled.

SETTINGS



Select the settings option on the feature bar.

Select a tile to access the settings.



Select the option to display extra information.

Ambient Lighting

You can adjust the ambient lighting settings.

Android Auto

You can switch Android Auto on and off.

Apple CarPlay

You can switch Apple CarPlay on and off.

Audio

You can adjust the audio settings.

Automatic Updates

You can switch automatic updates on and off and adjust the settings.

Bluetooth

You can switch Bluetooth on and off and pair your cell phone.

Clock

You can adjust the clock settings.

Display

You can adjust display settings like brightness and auto dim.

Emergency Assistance

You can switch Emergency Assistance on and off.

FordPass

You can adjust the FordPass settings.

General

You can adjust settings like language, measurement units, or reset the system.

Mobile Apps

You can adjust permissions, enable, disable, and update mobile apps.

Navigation (If Equipped)

You can adjust navigation settings like map preferences and route guidance.

Phone

You can connect and disconnect your device, or manage the connected device settings.

Seats (If Equipped)

You can adjust the position and the massage function of the seats.

Sound

You can adjust the sound settings.

Valet Mode (If Equipped)

You can enable and disable the valet mode.

Vehicle (If Equipped)

You can adjust the camera settings.

Voice Control

You can adjust the voice control settings.

Wi-Fi

You can switch Wi-Fi on and off and adjust the settings.

SYNC™ 3

SYNC™ 3 TROUBLESHOOTING

Voice Recognition

Symptom	Possible Cause and Resolution
The system does not understand what I am saying.	<ul style="list-style-type: none">– You are using the wrong voice commands.<ul style="list-style-type: none">• See Using Voice Recognition (page 417).• For a complete list of voice commands, refer to the local Ford website.– You are speaking too soon.<ul style="list-style-type: none">• Wait for the voice prompt before you speak.
The system does not understand the name of a track or artist.	<ul style="list-style-type: none">– Device limitation. Bluetooth does not support voice commands.<ul style="list-style-type: none">• Connect your device to a USB port.• If you have an iOS device, press and hold the voice control button on the steering wheel to use Siri to play specific tracks.– You are using the wrong voice commands.<ul style="list-style-type: none">• See Using Voice Recognition (page 417).• For a complete list of voice commands, refer to the local Ford website.– You are not saying the name exactly as it appears on your device.<ul style="list-style-type: none">• Say the name of the track or artist exactly as it appears on your device. Spell out any abbreviations in the name. The song or artist name may have some special characters that are not being recognized by the system.– The name contains special characters, for example * - or +.<ul style="list-style-type: none">• Rename the files on your device or use the touchscreen to select and play the track.

SYNC™ 3

Symptom	Possible Cause and Resolution
The system does not understand the name of a contact in the phonebook on my device and calls the wrong contact.	<ul style="list-style-type: none">– You are not saying the name exactly as it appears on your device.<ul style="list-style-type: none">• Say the first and last name of the contact exactly as it appears on your device. Spell out any abbreviations in the name.– The name contains special characters, for example *, - or +.<ul style="list-style-type: none">• Rename the contact on your device or use the touchscreen to select and call the contact.
The system does not understand foreign names of contacts in the phonebook on my device.	<ul style="list-style-type: none">– You are not saying the name exactly as it appears on your device.<ul style="list-style-type: none">• Say the first and last name of the contact exactly as it appears on your device. The system applies phonetic pronunciation rules of the selected language to the names of contacts in the phonebook on your device. Select the name of the contact on the touchscreen and use the Hear it option to get an idea of how the system expects you to pronounce it.
The system voice prompts and the pronunciation of some words does not seem to be very accurate.	<ul style="list-style-type: none">– Device limitation.<ul style="list-style-type: none">• The system uses text-to-speech technology and uses a synthetically generated voice rather than pre-recorded human voice.

SYNC™ 3

USB and Bluetooth Audio

Symptom	Possible Cause and Resolution
I cannot connect my device.	<ul style="list-style-type: none">– Device malfunction.<ul style="list-style-type: none">• Disconnect your device. Switch your device off, reset it and try again.– Cable connection issue.<ul style="list-style-type: none">• Correctly connect the cable to your device and the vehicle USB port.– Incompatible cable.<ul style="list-style-type: none">• Use the cable recommended by the manufacturer of your device.– Incorrect device settings.<ul style="list-style-type: none">• Make sure that your device does not have an auto-install program or active security settings.• Check that your device is not set only to charge.– Device lock screen enabled.<ul style="list-style-type: none">• Unlock your device before connecting it.
The system does not recognize my device.	<ul style="list-style-type: none">– Device limitation.<ul style="list-style-type: none">• Do not leave your device in your vehicle during very hot or very cold weather conditions.
The system does not understand the name of a track or artist.	<ul style="list-style-type: none">– Device limitation. Bluetooth does not support voice commands.<ul style="list-style-type: none">• Connect your device to a USB port.• If you have an iOS device, press and hold the voice control button on the steering wheel to use Siri to play specific tracks.

SYNC™ 3

Symptom	Possible Cause and Resolution
I cannot stream audio from my Bluetooth device.	<ul style="list-style-type: none">– Incompatible device.<ul style="list-style-type: none">• Check the compatibility of your device on the local Ford website.– Device not connected.<ul style="list-style-type: none">• Pair your device. See Phone (page 430).– Media player not running.<ul style="list-style-type: none">• Start the media player on your device.
The system does not recognize the music on my device.	<ul style="list-style-type: none">– Missing or incorrect audio file metadata, for example artist, song title, album or genre.<ul style="list-style-type: none">• Repair the files on your device.– Corrupt files.<ul style="list-style-type: none">• Repair the files on your device.– Copyright protected files.<ul style="list-style-type: none">• Use a device that contains files that are not copyright protected.– Unsupported file format.<ul style="list-style-type: none">• Repair or convert the files to a supported format. See Entertainment (page 425).– Device indexing required.<ul style="list-style-type: none">• Re-index your device. See Settings (page 438).– Device lock screen enabled.<ul style="list-style-type: none">• Unlock your device before connecting it.

SYNC™ 3

Symptom	Possible Cause and Resolution
Sometimes I cannot hear a track playing on my device.	<ul style="list-style-type: none">- Device malfunction.<ul style="list-style-type: none">· Disconnect your device. Switch your device off, reset it and try again.
When I disconnect my iOS device the audio volume is set to maximum.	<ul style="list-style-type: none">- Device limitation.<ul style="list-style-type: none">· Turn the volume down on your device
The system does not play the tracks on my USB drive in the correct order.	<p>If the system does not play the tracks on your USB device in the correct order, the following information could help:</p> <ul style="list-style-type: none">- If you are selecting USB as the audio source when the system is still indexing, SYNC plays tracks sorted alphabetically by file name in the root directory.- If you are selecting USB as the audio source after the system has finished indexing, SYNC plays all tracks sorted alphabetically by the title in the ID3 tag regardless of where they are located. SYNC uses the file name if the title in the ID3 Tag does not exist.- If you are selecting the option to play all tracks from the browsing menu, SYNC plays all tracks sorted alphabetically by the title in the ID3 tag regardless of where they are located. SYNC uses the file name if the title in the ID3 Tag does not exist.- If you are selecting a track when using the explore device option, SYNC plays tracks sorted alphabetically by file name in the folder you have selected. SYNC then plays all tracks in any subfolders in the folder you have selected.

SYNC™ 3

Phone

Symptom	Possible Cause and Resolution
During a call, I can hear excessive background noise.	<ul style="list-style-type: none"> – Incorrect cell phone settings. <ul style="list-style-type: none"> • Check and adjust the audio settings on your cell phone. Refer to your cell phone's user manual.
During a call, I can hear the other person but they cannot hear me.	<ul style="list-style-type: none"> – Cell phone malfunction. <ul style="list-style-type: none"> • Switch your cell phone off, reset it and try again. – Cell phone microphone muted. <ul style="list-style-type: none"> • Unmute your cell phone microphone.
During a call, I cannot hear the other person and they cannot hear me.	<ul style="list-style-type: none"> – System restart required. <ul style="list-style-type: none"> • Restart the system. Switch the ignition off and open the door. Close the door and lock the vehicle. Wait until the touchscreen is off and any illuminated USB ports are not illuminated. Unlock the vehicle, switch the ignition on and try again.
I cannot download phonebook.	<ul style="list-style-type: none"> – Incompatible cell phone. <ul style="list-style-type: none"> • Check the compatibility of your cell phone on the local Ford website. – Incorrect cell phone settings. <ul style="list-style-type: none"> • Allow the system to retrieve contacts from your cell phone. Refer to your cell phone's user manual. – Incorrect system settings. <ul style="list-style-type: none"> • Switch automatic phonebook download on. See Settings (page 438). – Cell phone malfunction. <ul style="list-style-type: none"> • Switch your cell phone off, reset it and try again.

SYNC™ 3

Symptom	Possible Cause and Resolution
A message displays suggesting that my phonebook has downloaded but it is empty or it has missing contacts.	<ul style="list-style-type: none">– Incorrect cell phone settings.<ul style="list-style-type: none">• Allow the system to retrieve contacts from your cell phone. Refer to your cell phone's user manual.• Check the location of the missing contacts on your cell phone. If they are stored on the SIM card, move them to the cell phone memory.– Incorrect system settings.<ul style="list-style-type: none">• Switch automatic phonebook download on. See Settings (page 438).
I cannot connect my cell phone.	<ul style="list-style-type: none">– Incompatible cell phone.<ul style="list-style-type: none">• Check the compatibility of your cell phone on the local Ford website.– Cell phone malfunction.<ul style="list-style-type: none">• Switch your cell phone off, reset it and try again.• Install the latest cell phone firmware.• Delete your device from system and delete SYNC from your device and try again.• Switch automatic phonebook download off. See Settings (page 438).
Text messaging does not work.	<ul style="list-style-type: none">– Incompatible cell phone.<ul style="list-style-type: none">• Check the compatibility of your cell phone on the local Ford website.– Cell phone malfunction.<ul style="list-style-type: none">• Switch your cell phone off, reset it and try again.
I cannot hear text messages.	<ul style="list-style-type: none">– Incompatible cell phone.<ul style="list-style-type: none">• Check the compatibility of your cell phone on the local Ford website.

SYNC™ 3

Navigation (If Equipped)

Symptom	Possible Cause and Resolution
I cannot enter a street name when I am abroad.	<ul style="list-style-type: none">– Incorrect entry method.<ul style="list-style-type: none">• Enter the street name with the country.
The system does not recognize coordinates.	<ul style="list-style-type: none">– You are using the wrong coordinates format.<ul style="list-style-type: none">• Use the format ##. #####, ##. ##### (for N/S, E/W). Add a minus before coordinates if the direction is West and keep a positive value if the direction is East, for example 12.5412 means East and -12.5412 means West.

SYNC™ 3

Apps

Symptom	Possible Cause and Resolution
The system cannot find any apps.	<ul style="list-style-type: none">– Incompatible device.<ul style="list-style-type: none">• You need an Android device with OS 4.3 or higher or an iOS device with iOS 8.0 or higher. Pair and connect your Android device to find AppLink compatible apps. Connect your Android or iOS device to a USB port or pair and connect using Bluetooth.
I have a compatible device and it is correctly connected but the system still cannot find any apps.	<ul style="list-style-type: none">– AppLink compatible apps not installed on your device.<ul style="list-style-type: none">• Download and install the latest version of the app.– AppLink compatible apps not running on your device.<ul style="list-style-type: none">• Start the apps to allow the system to find them and make sure you sign in to any apps if required.– Incorrect app settings.<ul style="list-style-type: none">• Check and adjust the app settings on your device and allow SYNC to access the app if required.
I have a compatible device, it is correctly connected and my apps are running but the system still cannot find any apps.	<ul style="list-style-type: none">– Apps failed to fully close.<ul style="list-style-type: none">• Restart the apps and try again.• If you have an Android device with apps that have an exit or quit option, use this and then restart the apps. Alternatively, use the force stop option in the settings menu on your device.• If you have an iOS device with iOS 7.0 or higher, tap the home button on your device twice and then swipe the app upward to close it.

SYNC™ 3

Symptom	Possible Cause and Resolution
I have an Android device that is correctly connected, I have restarted my apps and they are running but the system still cannot find them.	– An issue on some older versions of the Android operating system could result in apps not being found. <ul style="list-style-type: none">• Switch Bluetooth off and on again to force the system to reconnect to your device.
I have an iOS device that is correctly connected, I have restarted my apps and they are running but the system still cannot find them.	– Cable connection issue. <ul style="list-style-type: none">• Disconnect the cable from your device, wait for a moment and then connect it again to force the system to reconnect to your device.
I have an Android device running a media app which the system has found but I cannot hear the sound or the sound is very quiet.	– Device volume is low. <ul style="list-style-type: none">• Turn the volume up on your device.
I have an Android device running a number of compatible apps but the system cannot find all of them.	– Device limitation. Some Android devices have a limited number of Bluetooth ports that apps can use to connect. If you have more apps running on your device than the number of available Bluetooth ports, the system cannot find all of them. <ul style="list-style-type: none">• Close some of the apps to allow the system to find those that you want to use.

SYNC™ 3

Wi-Fi Connectivity

Symptom	Possible Cause and Resolution
I cannot connect to a Wi-Fi network.	<ul style="list-style-type: none">– Password error.<ul style="list-style-type: none">• Enter the correct network password.– Weak network signal.<ul style="list-style-type: none">• Move your vehicle closer to the Wi-Fi hotspot or to a place where the network signal is not obstructed.– Multiple access points in range with the same SSID.<ul style="list-style-type: none">• Use a unique name for your SSID. Do not use the default name unless it contains a unique identifier, for example as part of the MAC address.
The Wi-Fi connection disconnects after successful connection.	<ul style="list-style-type: none">– Weak network signal.<ul style="list-style-type: none">• Move your vehicle closer to the Wi-Fi hotspot or to a place where the network signal is not obstructed.
I am close to a Wi-Fi hotspot but the network signal strength is weak.	<ul style="list-style-type: none">– Obstructed network signal.<ul style="list-style-type: none">• If your vehicle has a heated windshield, position your vehicle so that the windshield is not facing the Wi-Fi hotspot.• If your vehicle has metallic tinting on the windows but not on the windshield, position your vehicle so that the windshield is facing the Wi-Fi hotspot or open the windows that are facing the hotspot.• If your vehicle has metallic tinting on the windows and the windshield, open the windows that are facing the hotspot.• If your vehicle is in a garage and you have the garage door closed, open the garage door.

SYNC™ 3

Symptom	Possible Cause and Resolution
I cannot see a network in the list of available networks that I expect to see.	<ul style="list-style-type: none"> – Hidden network. <ul style="list-style-type: none"> • Make the network visible and try again.
Software downloads take too long.	<ul style="list-style-type: none"> – Weak network signal <ul style="list-style-type: none"> • Move your vehicle closer to the Wi-Fi hotspot or to a place where the network signal is not obstructed. – Wi-Fi hotspot in high demand or has a slow Internet connection. <ul style="list-style-type: none"> • Use a more reliable Wi-Fi hotspot.
The system seems to connect to a Wi-Fi network and the signal strength is excellent but the software does not update.	<ul style="list-style-type: none"> – No software update available. – Wi-Fi network requires a subscription or acceptance of terms and conditions. <ul style="list-style-type: none"> • Test the connection using another device. If the network requires a subscription or acceptance of terms and conditions, contact the network service provider.

Resetting the System

1. Simultaneously press and hold the seek up and the audio unit power buttons until the screen goes black.
2. Wait three minutes to allow the system to complete the reset.
3. Press the audio unit power button to switch the system on.

Note: *You can reset the system to restore functionality that has stopped working. The system reset is designed to restore functionality and not delete any data that you have stored.*

Additional Information and Assistance

For additional information and assistance, we recommend that you contact an authorized dealer or refer to the local Ford website.

Appendices

ELECTROMAGNETIC COMPATIBILITY

 **WARNING:** Do not place objects or mount equipment on or near the airbag cover, on the side of the front or rear seatbacks, or in areas that may come into contact with a deploying airbag. Failure to follow these instructions may increase the risk of personal injury in the event of a crash.

 **WARNING:** Do not fasten antenna cables to vehicle wiring, fuel pipes and brake pipes.

 **WARNING:** Keep antenna and power cables at least 10 cm (4 in) from any electronic modules and airbags.

Note: We test and certify your vehicle to meet electromagnetic compatibility legislation. It is your responsibility to make sure that any equipment an authorized dealer installs on your vehicle complies with applicable local legislation and other requirements. Installation of some aftermarket electronic devices could degrade the performance of vehicle functions, which use radio frequency signals such as broadcast radio receiver, tire pressure monitoring system, push button start, **Bluetooth**[®] connectivity or satellite navigation.

Note: Any radio frequency transmitter equipment in your vehicle (such as cellular telephones and amateur radio transmitters) must keep to the parameters in the following illustrations and table. We do not provide any other special provisions or conditions for installations or use.

Appendices

Car/SUV

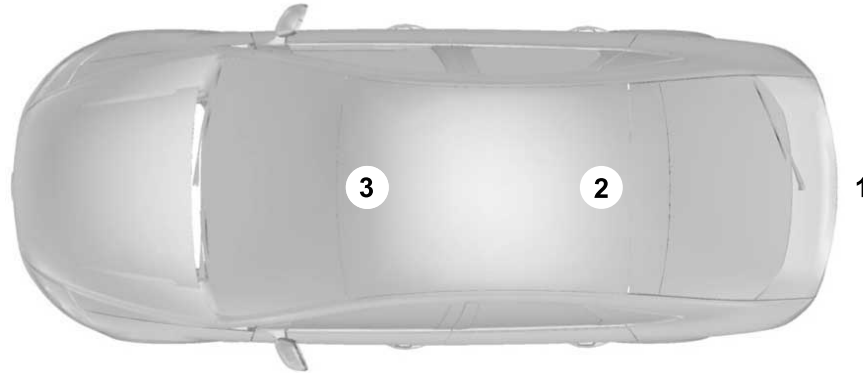

Appendices

Van

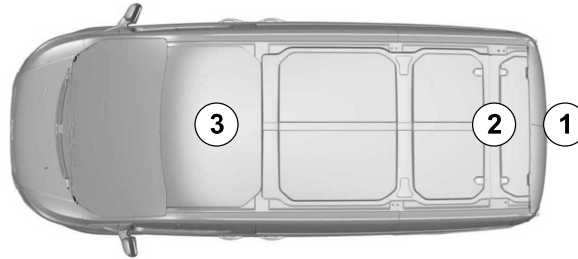

Appendices

Truck

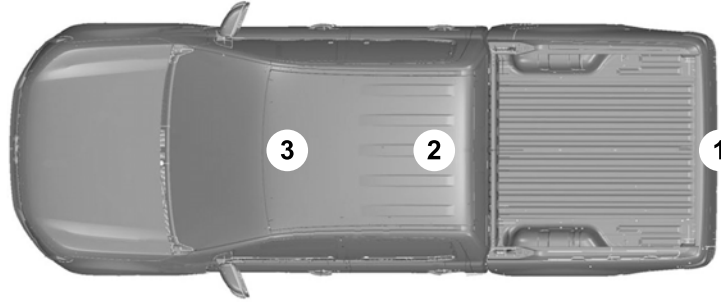

Frequency Band MHz	Maximum output power Watt (Peak RMS)	Antenna Positions
1-30	50	1
50-54	50	2, 3
68-88	50	2, 3
142-176	50	2, 3
380-512	50	2, 3
806-870	10	2, 3

Appendices

END USER LICENSE AGREEMENT

VEHICLE SOFTWARE END USER LICENSE AGREEMENT (EULA)

- You ("You" or "Your" as applicable) have acquired a vehicle having several devices, including SYNC ® and various control modules, ("DEVICES") that include software licensed or owned by Ford Motor Company and its affiliates ("FORD MOTOR COMPANY"). Those software products of FORD MOTOR COMPANY origin, as well as associated media, printed materials, and "online" or electronic documentation ("SOFTWARE") are protected by international intellectual property laws and treaties. The SOFTWARE is licensed, not sold. All rights reserved.
- The SOFTWARE may interface with and/or communicate with, or may be later upgraded to interface with and/or communicate with additional software and/or systems provided by FORD MOTOR COMPANY.

IF YOU DO NOT AGREE TO THIS END USER LICENSE AGREEMENT ("EULA") DO NOT USE THE DEVICES OR COPY THE SOFTWARE. ANY USE OF THE SOFTWARE, INCLUDING BUT NOT LIMITED TO USE ON THE DEVICES, WILL CONSTITUTE YOUR AGREEMENT TO THIS EULA (OR RATIFICATION OF ANY PREVIOUS CONSENT).

GRANT OF SOFTWARE LICENSE: This EULA grants you the following license:

- You may use the SOFTWARE as installed on the DEVICES and as otherwise interfacing with systems and/or services provide by or through FORD MOTOR COMPANY or its third party software and service providers.

Description of Other Rights and Limitations

- **Speech Recognition:** If the SOFTWARE includes speech recognition component(s), you should understand that speech recognition is an inherently statistical process and that recognition errors are inherent in the process. Neither FORD MOTOR COMPANY nor its

suppliers shall be liable for any damages arising out of errors in the speech recognition process. It is your responsibility to monitor any speech recognition functions included in the system.

- **Limitations on Reverse Engineering, Decompilation and Disassembly:** You may not reverse engineer, decompile, translate, disassemble or attempt to discover any source code or underlying ideas or algorithms of the SOFTWARE nor permit others to reverse engineer, decompile or disassemble the SOFTWARE, except and only to the extent that such activity is expressly permitted by applicable law notwithstanding this limitation or to the extent as may be permitted by the licensing terms governing use of any open source components included with the SOFTWARE.
- **Limitations on Distributing, Copying, Modifying and Creating Derivative Works:** You may not distribute, copy, make modifications to or create derivative works based on the SOFTWARE, except and only to the extent that such activity is expressly

Appendices

permitted by applicable law notwithstanding this limitation or to the extent as may be permitted by the licensing terms governing use of any open source components included with the SOFTWARE.

- **Single EULA:** The end user documentation for the DEVICES and related systems and services may contain multiple EULAs, such as multiple translations and/or multiple media versions (e.g., in the user documentation and in the software). Even if you receive multiple EULAs, you are licensed to use only one (1) copy of the SOFTWARE.
- **SOFTWARE Transfer:** You may permanently transfer your rights under this EULA only as part of a sale or transfer of the DEVICES, provided you retain no copies, you transfer all of the SOFTWARE (including all component parts, the media and printed materials, any upgrades, and, if applicable, the Certificate(s) of Authenticity), and the recipient agrees to the terms of this EULA. If the SOFTWARE is an upgrade, any transfer must include all prior versions of the SOFTWARE.
- **Termination:** Without prejudice to any other rights, FORD MOTOR COMPANY may terminate this EULA if you fail to comply with the terms and conditions of this EULA.
- **Internet-Based Services Components:** The SOFTWARE may contain components that enable and facilitate the use of certain Internet-based services. You acknowledge and agree that FORD MOTOR COMPANY, third party software and service suppliers, its affiliates and/or its designated agent may automatically check the version of the SOFTWARE and/or its components that you are utilizing and may provide upgrades or supplements to the SOFTWARE that may be automatically downloaded to your DEVICES.
- **Additional Software/Services:** The SOFTWARE may permit FORD MOTOR COMPANY, third party software and service suppliers, its affiliates and/or its designated agent to provide or make available to you SOFTWARE updates, supplements, add-on components, or Internet-based services components of the SOFTWARE after the date you obtain your initial copy of the SOFTWARE ("Supplemental Components".) SOFTWARE updates may cause you to

incur additional charges from your wireless service provider. If FORD MOTOR COMPANY or third party software and services suppliers provide or make available to you Supplemental Components and no other EULA terms are provided along with the Supplemental Components, then the terms of this EULA shall apply. FORD MOTOR COMPANY, its affiliates and/or its designated agent reserve the right to discontinue without liability any Internet-based services provided to you or made available to you through the use of the SOFTWARE.

Appendices

- **Links to Third Party Sites:** The SOFTWARE may provide you with the ability to link to third party sites. The third party sites are not under the control of FORD MOTOR COMPANY, its affiliates and/or its designated agent. Neither FORD MOTOR COMPANY nor its affiliates nor its designated agent are responsible for (i) the contents of any third party sites, any links contained in third party sites, or any changes or updates to third party sites, or (ii) webcasting or any other form of transmission received from any third party sites. If the SOFTWARE provides links to third party sites, those links are provided to you only as a convenience, and the inclusion of any link does not imply an endorsement of the third party site by FORD MOTOR COMPANY, its affiliates and/or its designated agent.
- **Obligation to Drive Responsibly:** You recognize your obligation to drive responsibly and keep attention on the road. You will read and abide with the DEVICES operating instructions particularly as they pertain to safety and you agree to assume any risk associated with the use of the DEVICES.

UPGRADES AND RECOVERY MEDIA: If the SOFTWARE is provided by FORD MOTOR COMPANY separate from the DEVICES on media such as a ROM chip, CD ROM disk(s) or via web download or other means, and is labeled "For Upgrade Purposes Only" or "For Recovery Purposes Only" you may install one (1) copy of such SOFTWARE onto the DEVICES as a replacement copy for the existing SOFTWARE, and use it in accordance with this EULA, including any additional EULA terms accompanying the upgrade SOFTWARE.

INTELLECTUAL PROPERTY RIGHTS: All title and intellectual property rights in and to the SOFTWARE (including but not limited to any images, photographs, animations, video, audio, music, text and "applets" incorporated into the SOFTWARE), the accompanying printed materials, and any copies of the SOFTWARE, are owned by FORD MOTOR COMPANY, or its affiliates or suppliers. The SOFTWARE is licensed, not sold. You may not copy the printed materials accompanying the SOFTWARE. All title and intellectual property rights in and to the content which may be accessed through use of the SOFTWARE is the property of the respective content owner and may be protected by applicable copyright or other intellectual property laws and treaties. This EULA grants

you no rights to use such content outside its intended use. All rights not specifically granted under this EULA are reserved by FORD MOTOR COMPANY, its affiliates, and third party software and service providers and suppliers. Use of any on-line services which may be accessed through the SOFTWARE may be governed by the respective terms of use relating to such services. If this SOFTWARE contains documentation that is provided only in electronic form, you may print one copy of such electronic documentation.

EXPORT RESTRICTIONS: You acknowledge that the SOFTWARE is subject to U.S. and European Union export jurisdiction. You agree to comply with all applicable international and national laws that apply to the SOFTWARE, including the U.S. Export Administration Regulations, as well as end-user, end-use and destination restrictions issued by U.S. and other governments.

TRADEMARKS: This EULA does not grant you any rights in connection with any trademarks or service marks of FORD MOTOR COMPANY, its affiliates, and third party software and service providers.

Appendices

The **Bluetooth®** word mark and logos are registered trademarks owned by **Bluetooth SIG, Inc.** and any use of such marks by Ford Motor Company is under license. Other trademarks and trade names are those of their respective owners.

PRODUCT SUPPORT: Please refer to FORD MOTOR COMPANY instructions provided in the documentation for the DEVICES product support, such as the vehicle owner guide.

Should you have any questions concerning this EULA, or if you desire to contact FORD MOTOR COMPANY for any other reason, please refer to the address provided in the documentation for the DEVICES.

No Liability for Certain Damages: EXCEPT AS PROHIBITED BY LAW, FORD MOTOR COMPANY, ANY THIRD PARTY SOFTWARE OR SERVICES SUPPLIERS, AND THEIR AFFILIATES SHALL HAVE NO LIABILITY FOR ANY INDIRECT, SPECIAL, CONSEQUENTIAL OR INCIDENTAL DAMAGES ARISING FROM OR IN CONNECTION WITH THE USE OR PERFORMANCE OF THE SOFTWARE. THIS LIMITATION SHALL APPLY EVEN IF ANY REMEDY FAILS OF ITS ESSENTIAL PURPOSE. THERE ARE NO WARRANTIES OTHER THAN THOSE THAT MAY BE EXPRESSLY PROVIDED FOR YOUR NEW VEHICLE.

SYNC® Automotive Important Safety Information Read and follow instructions:

- Before using your SYNC® system, read and follow all instructions and safety information provided in this end user manual ("Owner Guide".) Not following precautions found in the Owner Guide can lead to an accident or other serious injuries.

General Operation

- **Voice Command Control:** Certain functions within the SYNC® system may be accomplished using voice commands. Using voice commands while driving helps you to operate the system without removing your hands from the wheel or eyes from the road.
- **Prolonged Views of Screen:** Do not access any function requiring a prolonged view of the screen while you are driving. Pull over in a safe and legal manner before attempting to access a function of the system requiring prolonged attention.

- **Volume Setting:** Do not raise the volume excessively. Keep the volume at a level where you can still hear outside traffic and emergency signals while driving. Driving while unable to hear these sounds could cause an accident.
- **Navigation Features:** Any navigation features included in the system are intended to provide turn by turn instructions to get you to a desired destination. Please make certain all persons using this system carefully read and follow instructions and safety information fully.
- **Distraction Hazard:** Any navigation features may require manual (non-verbal) setup. Attempting to perform such set-up or insert data while driving can distract your attention and could cause an accident or other serious injury. Stop the vehicle in a safe and legal manner before attempting these operations.

Appendices

- **Let Your Judgment Prevail:** Any navigation features are provided only as an aid. Make your driving decisions based on your observations of local conditions and existing traffic regulations. Any such feature is not a substitute for your personal judgment. Any route suggestions made by this system should never replace any local traffic regulations or your personal judgment or knowledge of safe driving practices.
- **Route Safety:** Do not follow the route suggestions if doing so would result in an unsafe or illegal maneuver, if you would be placed in an unsafe situation, or if you would be directed into an area that you consider unsafe. The driver is ultimately responsible for the safe operation of the vehicle and therefore, must evaluate whether it is safe to follow the suggested directions.
- **Potential Map Inaccuracy:** Maps used by this system may be inaccurate because of changes in roads, traffic controls or driving conditions. Always use good judgment and common sense when following the suggested routes.
- **Emergency Services:** Do not rely on any navigation features included in the system to route you to emergency services. Ask local authorities or an emergency services operator for these locations. Not all emergency services such as police, fire stations, hospitals and clinics are likely to be contained in the map database for such navigation features.

Appendices

Your Responsibilities and Assumptions of Risk

Appendices

- You agree to each of the following: (a) Any use of the SOFTWARE while driving an automobile or other vehicle in violation of applicable law or otherwise driving in an unsafe manner presents a significant risk of distracted driving and should not be attempted under any circumstances; (b) Use of the SOFTWARE at excessive volume poses a significant risk of hearing damage and should not be attempted under any circumstances; (c) The SOFTWARE may not be compatible with new or different versions of an operating system, third party software, or third party services, and the SOFTWARE may potentially cause a critical failure of an operating system, third party software, or third party service. (d) Any third party service accessed by or third party software used with the SOFTWARE (I) may charge an additional fee for access, (ii) may not work correctly, on an uninterrupted basis, or error free, (iii) may change streaming formats or discontinue operation, (iv) may contain adult, profane or offensive content; and (v) may contain inaccurate, false or misleading traffic, weather, financial or safety information or other content; and (e) Use of the SOFTWARE may cause you to incur additional charges

from your wireless service provider (WSP) and any data or minute calculators that may be included in the software program are for reference only, are not warranted in any way and should not be relied upon in anyway.

- When using the SOFTWARE, you agree to be responsible for and assume the entire risk to the items set forth in Section (a) – (e) above.

Disclaimer of Warranty

YOU EXPRESSLY ACKNOWLEDGE AND AGREE THAT USE OF THE DEVICES AND SOFTWARE IS AT YOUR SOLE RISK AND THAT THE ENTIRE RISK AS TO SATISFACTORY QUALITY, PERFORMANCE, COMPATIBILITY, ACCURACY AND EFFORT IS WITH YOU. TO THE MAXIMUM EXTENT PERMITTED BY APPLICABLE LAW, THE SOFTWARE AND ANY THIRD PARTY SOFTWARE OR THIRD-PARTY SERVICES ARE PROVIDED "AS IS" AND "AS AVAILABLE", WITH ALL FAULTS AND WITHOUT WARRANTY OF ANY KIND, AND FORD MOTOR COMPANY HEREBY DISCLAIMS ALL WARRANTIES AND CONDITIONS WITH RESPECT TO THE SOFTWARE, THIRD PARTY SOFTWARE, AND THIRD-PARTY SERVICES, EITHER EXPRESS, IMPLIED OR STATUTORY, INCLUDING, BUT

NOT LIMITED TO, THE IMPLIED WARRANTIES AND/OR CONDITIONS OF MERCHANTABILITY, OF SATISFACTORY QUALITY, OF FITNESS FOR AN ARTICULAR PURPOSE, OF ACCURACY, OF QUIET ENJOYMENT, AND NON-INFRINGEMENT OF THIRD-PARTY RIGHTS. FORD MOTOR COMPANY DOES NOT WARRANT (a) AGAINST INTERFERENCE WITH YOUR ENJOYMENT OF THE SOFTWARE, THIRD PARTY SOFTWARE, OR THIRD-PARTY SERVICES, (b) THAT THE SOFTWARE, THIRD PARTY SOFTWARE, OR THIRD-PARTY SERVICES WILL MEET YOUR REQUIREMENTS, (c) THAT THE OPERATION OF THE SOFTWARE, THIRD PARTY SOFTWARE, OR THIRD-PARTY SERVICES WILL BE UNINTERRUPTED OR ERROR-FREE, (d) OR THAT DEFECTS IN THE SOFTWARE, THIRD PARTY SOFTWARE, OR THIRD-PARTY SERVICES WILL BE CORRECTED. NO ORAL OR WRITTEN INFORMATION OR ADVICE GIVEN BY FORD MOTOR COMPANY OR ITS AUTHORIZED REPRESENTATIVE SHALL CREATE A WARRANTY. SHOULD THE SOFTWARE, THIRD PARTY SOFTWARE, OR THIRD-PARTY SERVICES PROVE DEFECTIVE, YOU ASSUME THE ENTIRE COST OF ALL NECESSARY SERVICING, REPAIR OR CORRECTION. SOME JURISDICTIONS DO NOT ALLOW THE

Appendices

DISCLAIMER OF IMPLIED WARRANTIES OR LIMITATIONS ON APPLICABLE STATUTORY RIGHTS OF A CONSUMER, SO THE ABOVE DISCLAIMER MAY NOT FULLY APPLY TO YOU. THE SOLE WARRANTY PROVIDED BY FORD MOTOR COMPANY SHALL BE FOUND IN THE WARRANTY INFORMATION INCLUDING WITH YOUR OWNER GUIDE. TO THE EXTENT THAT THERE IS ANY CONFLICT BETWEEN THE TERMS OF THIS SECTION AND THE WARRANTY BOOKLET, THE WARRANTY BOOKLET SHALL CONTROL.

Applicable Law, Venue, Jurisdiction

- The laws of the State of Michigan govern this EULA and Your use of the SOFTWARE. Your use of the SOFTWARE may also be subject to other local, state, national, or international laws. Any litigation arising out of or related to this EULA shall be brought and maintained exclusively in a court of the State of Michigan located in Wayne County or in the United States District Court for the Eastern District of Michigan. You hereby consent to submit to the personal

jurisdiction of a court in the State of Michigan located in Wayne County and the United States District Court for the Eastern District of Michigan for any dispute arising out of or relating to this EULA.

Binding Arbitration and Class Action Waiver

(a) Application. This Section applies to any dispute EXCEPT IT DOES NOT INCLUDE A DISPUTE RELATING TO COPYRIGHT INFRINGEMENT, OR TO THE ENFORCEMENT OR VALIDITY OF YOUR, FORD MOTOR COMPANY, OR ANY OF FORD MOTOR COMPANY'S LICENSORS' INTELLECTUAL PROPERTY RIGHTS. Dispute means any dispute, action, or other controversy between You and FORD MOTOR COMPANY, other than the exceptions listed above, concerning the SOFTWARE (including its price) or this EULA, whether in contract, warranty, tort, statute, regulation, ordinance, or any other legal or equitable basis.

(b) Notice of Dispute. In the event of a Dispute, You or FORD MOTOR COMPANY must give the other a "Notice of Dispute", which is a written statement of the name, address, and contact information of the party giving it, the facts giving rise to the dispute, and the relief requested. You and FORD

MOTOR COMPANY will attempt to resolve any dispute through informal negotiation within 60 days from the date the Notice of Dispute is sent. After 60 days, You or FORD MOTOR COMPANY may commence arbitration.

(c) Small claims court. You may also litigate any dispute in small claims court in your county of residence or FORD MOTOR COMPANY'S principal place of business, if the dispute meets all requirements to be heard in the small claims court. You may litigate in small claims court whether or not You negotiated informally first.

(d) Binding arbitration. If You and FORD MOTOR COMPANY, do not resolve any dispute by informal negotiation or in small claims court, any other effort to resolve the dispute will be conducted exclusively by binding arbitration. You are giving up the right to litigate (or participate in as a party or class member) all disputes in court before a judge or jury. Instead, all disputes will be resolved before a neutral arbitrator, whose decision will be final except for a limited right of appeal under the Federal Arbitration Act. Any court with jurisdiction over the parties may enforce the arbitrator's award.

Appendices

(e) Class action waiver. Any proceedings to resolve or litigate any dispute in any forum will be conducted solely on an individual basis. Neither you nor FORD MOTOR COMPANY, will seek to have any dispute heard as a class action, as a private attorney general action, or in any other proceeding in which any party acts or proposes to act in a representative capacity. No arbitration or proceeding will be combined with another without the prior written consent of all parties to all affected arbitrations or proceedings.

(f) Arbitration procedure. Any arbitration will be conducted by the American Arbitration Association (the “AAA”), under its Commercial Arbitration Rules. If You are an individual and use the SOFTWARE for personal or vehicle use, or if the value of the dispute is \$75,000 or less whether or not You are an individual or how You use the SOFTWARE, the AAA Supplementary Procedures for Consumer-Related Disputes will also apply. To commence arbitration, submit a Commercial Arbitration Rules Demand for Arbitration form to the AAA. You may request a telephonic or in-person hearing by following the AAA rules. In a dispute involving \$10,000 or less, any hearing will be telephonic unless the arbitrator finds good cause to hold an in-person hearing instead. For more information, see adr.org or

call 1-800-778-7879. You agree to commence arbitration only in your county of residence or FORD MOTOR COMPANY’S principal place of business. The arbitrator may award the same damages to You individually as a court could. The arbitrator may award declaratory or injunctive relief only to You individually, and only to the extent required to satisfy Your individual claim.

(g) Arbitration fees and incentives.

- i. Disputes involving \$75,000 or less. FORD MOTOR COMPANY will promptly reimburse your filing fees and pay the AAA’s and arbitrator’s fees and expenses. If you reject FORD MOTOR COMPANY’S last written settlement offer made before the arbitrator was appointed (“last written offer”), your dispute goes all the way to an arbitrator’s decision (called an “award”), and the arbitrator awards you more than the last written offer, FORD MOTOR COMPANY will give you three incentives: (1) pay the greater of the award or \$1,000; (2) pay twice your reasonable attorney’s fees, if any; and (3)

reimburse any expenses (including expert witness fees and costs) that your attorney reasonably accrues for investigating, preparing, and pursuing your claim in arbitration. The arbitrator will determine the amounts.

- ii. Disputes involving more than \$75,000. The AAA rules will govern payment of filing fees and the AAA’s and arbitrator’s fees and expenses.
- iii. Disputes involving any amount. In any arbitration you commence, FORD MOTOR COMPANY will seek its AAA or arbitrator’s fees and expenses, or Your filing fees it reimbursed, only if the arbitrator finds the arbitration frivolous or brought for an improper purpose. In any arbitration FORD MOTOR COMPANY commences, it will pay all filing, AAA, and arbitrator’s fees and expenses. It will not seek its attorney’s fees or expenses from you in any arbitration. Fees and expenses are not counted in determining how much a dispute involves.

Appendices

(h) Claims or disputes must be filed within one year. To the extent permitted by law, any claim or dispute under this EULA to which this Section applies must be filed within one year in small claims court (Section c) or in arbitration (Section d). The one-year period begins when the claim or dispute first could be filed. If such a claim or dispute is not filed within one year, it is permanently barred.

(i) Severability. If the class action waiver (Section e) is found to be illegal or unenforceable as to all or some parts of a dispute, then that portion of Section e will not apply to those parts. Instead, those parts will be severed and proceed in a court of law, with the remaining parts proceeding in arbitration. If any other provision of that portion Section e is found to be illegal or unenforceable, that provision will be severed with the remainder of Section e remaining in full force and effect.

Telenav Software End User License Agreement

Please read these terms and conditions carefully before you use the TeleNav Software. Your use of the TeleNav Software indicates that you accept these terms and conditions. If you do not accept these terms and conditions, do not break the seal of the package, launch, or otherwise use the

TeleNav Software. TeleNav may revise this Agreement and the privacy policy at any time, with or without notice to you. You agree to visit <http://www.telenav.com> from time to time to review the then current version of this Agreement and of the privacy policy.

1. Safe and Lawful Use

You acknowledge that devoting attention to the TeleNav Software may pose a risk of injury or death to you and others in situations that otherwise require your undivided attention, and you therefore agree to comply with the following when using the TeleNav Software:

(a) observe all traffic laws and otherwise drive safely;

(b) use your own personal judgment while driving. If you feel that a route suggested by the TeleNav Software instructs you to perform an unsafe or illegal maneuver, places you in an unsafe situation, or directs you into an area that you consider to be unsafe, do not follow such instructions;

(c) do not input destinations, or otherwise manipulate the TeleNav Software, unless your vehicle is stationary and parked;

(d) do not use the TeleNav Software for any illegal, unauthorized, unintended, unsafe, hazardous, or unlawful purposes, or in any manner inconsistent with this Agreement;

(e) arrange all GPS and wireless devices and cables necessary for use of the TeleNav Software in a secure manner in your vehicle so that they will not interfere with your driving and will not prevent the operation of any safety device (such as an airbag).

You agree to indemnify and hold TeleNav harmless against all claims resulting from any dangerous or otherwise inappropriate use of the TeleNav Software in any moving vehicle, including as a result of your failure to comply with the directions above.

2. Account Information

You agree: (a) when registering the TeleNav Software, to provide TeleNav with true, accurate, current, and complete information about yourself, and (b) to inform TeleNav promptly of any changes to such information, and to keep it true, accurate, current and complete.

Appendices

3. Software License

- Subject to your compliance with the terms of this Agreement, TeleNav hereby grants to you a personal, non-exclusive, non-transferable license (except as expressly permitted below in connection with your permanent transfer of the TeleNav Software license), without the right to sublicense, to use the TeleNav Software (in object code form only) in order to access and use the TeleNav Software. This license shall terminate upon any termination or expiration of this Agreement. You agree that you will use the TeleNav Software only for your personal business or leisure purposes, and not to provide commercial navigation services to other parties.

3.1 License Limitations

- **(a)** reverse engineer, decompile, disassemble, translate, modify, alter or otherwise change the TeleNav Software or any part thereof; **(b)** attempt to derive the source code, audio library or structure of the TeleNav Software without the prior express written consent of TeleNav; **(c)** remove from the TeleNav Software, or alter, any of TeleNav's or its suppliers' trademarks, trade names, logos, patent or copyright notices, or other notices or

markings; **(d)** distribute, sublicense or otherwise transfer the TeleNav Software to others, except as part of your permanent transfer of the TeleNav Software; or **(e)** use the TeleNav Software in any manner that

- i. infringes the intellectual property or proprietary rights, rights of publicity or privacy or other rights of any party,
- ii. violates any law, statute, ordinance or regulation, including but not limited to laws and regulations related to spamming, privacy, consumer and child protection, obscenity or defamation, or
- iii. is harmful, threatening, abusive, harassing, tortuous, defamatory, vulgar, obscene, libelous, or otherwise objectionable; and (f) lease, rent out, or otherwise permit unauthorized access by third parties to the TeleNav Software without advanced written permission of TeleNav.

4. Disclaimers

- To the fullest extent permissible pursuant to applicable law, in no event will TeleNav, its licensors and suppliers, or agents or employees of any of the foregoing, be liable for any decision made or action taken by you or anyone else in reliance on the information provided by

the TeleNav Software. TeleNav also does not warrant the accuracy of the map or other data used for the TeleNav Software. Such data may not always reflect reality due to, among other things, road closures, construction, weather, new roads and other changing conditions. You are responsible for the entire risk arising out of your use of the TeleNav Software. For example but without limitation, you agree not to rely on the TeleNav Software for critical navigation in areas where the well-being or survival of you or others is

Appendices

dependent on the accuracy of navigation, as the maps or functionality of the TeleNav Software are not intended to support such high risk applications, especially in more remote geographical areas.

- TELENAV EXPRESSLY DISCLAIMS AND EXCLUDES ALL WARRANTIES IN CONNECTION WITH THE TELENAV SOFTWARE, WHETHER STATUTORY, EXPRESS OR IMPLIED, INCLUDING ALL WARRANTIES WHICH MAY ARISE FROM COURSE OF DEALING, CUSTOM OR TRADE AND INCLUDING, BUT NOT LIMITED TO, THE IMPLIED WARRANTIES OF MERCHANTABILITY, FITNESS FOR A PARTICULAR PURPOSE AND NON-INFRINGEMENT OF THIRD PARTY RIGHTS WITH RESPECT TO THE TELENAV SOFTWARE.
- Certain jurisdictions do not permit the disclaimer of certain warranties, so this limitation may not apply to you.

5. Limitation of Liability

- TO THE EXTENT PERMITTED UNDER APPLICABLE LAW, UNDER NO CIRCUMSTANCES SHALL TELENAV OR ITS LICENSORS AND SUPPLIERS BE LIABLE TO YOU OR TO ANY THIRD PARTY FOR ANY INDIRECT, INCIDENTAL,

CONSEQUENTIAL, SPECIAL OR EXEMPLARY DAMAGES (INCLUDING IN EACH CASE, BUT NOT LIMITED TO, DAMAGES FOR THE INABILITY TO USE THE EQUIPMENT OR ACCESS DATA, LOSS OF DATA, LOSS OF BUSINESS, LOSS OF PROFITS, BUSINESS INTERRUPTION OR THE LIKE) ARISING OUT OF THE USE OF OR INABILITY TO USE THE TELENAV SOFTWARE, EVEN IF TELENAV HAS BEEN ADVISED OF THE POSSIBILITY OF SUCH DAMAGES. NOTWITHSTANDING ANY DAMAGES THAT YOU MIGHT INCUR FOR ANY REASON WHATSOEVER (INCLUDING, WITHOUT LIMITATION, ALL DAMAGES REFERENCED HEREIN AND ALL DIRECT OR GENERAL DAMAGES IN CONTRACT, TORT (INCLUDING NEGLIGENCE) OR OTHERWISE), THE ENTIRE LIABILITY OF TELENAV AND OF ALL OF TELENAV'S SUPPLIERS SHALL BE LIMITED TO THE AMOUNT ACTUALLY PAID BY YOU FOR THE TELENAV SOFTWARE. SOME STATES AND/OR JURISDICTIONS DO NOT ALLOW THE EXCLUSION OR LIMITATION OF INCIDENTAL OR CONSEQUENTIAL DAMAGES, SO THE ABOVE LIMITATIONS OR EXCLUSIONS MAY NOT APPLY TO YOU.

6. Arbitration and Governing Law

- You agree that any dispute, claim or controversy arising out of or relating to this Agreement or the TeleNav Software shall be settled by independent arbitration involving a neutral arbitrator and administered by the American Arbitration Association in the County of Santa Clara, California. The arbitrator shall apply the Commercial Arbitration Rules of the American Arbitration Association, and the judgment upon the award rendered by the arbitrator may be entered by any court having jurisdiction. Note that there is no judge or jury in an arbitration proceeding and the decision of the arbitrator shall be binding upon both parties. You expressly agree to waive your right to a jury trial. This Agreement and performance hereunder will be governed by and construed in accordance with the laws of the State of California, without giving effect to its conflict of law provisions. To the extent judicial action is necessary in connection with the binding arbitration, both TeleNav and you

Appendices

agree to submit to the exclusive jurisdiction of the courts of the County of Santa Clara, California. The United Nations Convention on Contracts for the International Sale of Goods shall not apply.

7. Assignment

- You may not resell, assign, or transfer this Agreement or any of your rights or obligations, except in totality, in connection with your permanent transfer of the TeleNav Software, and expressly conditioned upon the new user of the TeleNav Software agreeing to be bound by the terms and conditions of this Agreement. Any such sale, assignment or transfer that is not expressly permitted under this paragraph will result in immediate termination of this Agreement, without liability to TeleNav, in which case you and all other parties shall immediately cease all use of the TeleNav Software. Notwithstanding the foregoing, TeleNav may assign this Agreement to any other party at any time without notice, provided the assignee remains bound by this Agreement.

8. Miscellaneous

8.1

This Agreement constitutes the entire agreement between TeleNav and you with respect to the subject matter hereof.

8.2

Except for the limited licenses expressly granted in this Agreement, TeleNav retains all right, title and interest in and to the TeleNav Software, including without limitation all related intellectual property rights. No licenses or other rights which are not expressly granted in this Agreement are intended to, or shall be, granted or conferred by implication, statute, inducement, estoppel or otherwise, and TeleNav and its suppliers and licensors hereby reserve all of their respective rights other than the licenses explicitly granted in this Agreement.

8.3

By using the TeleNav Software, you consent to receive from TeleNav all communications, including notices, agreements, legally required disclosures or other information in connection with the TeleNav Software (collectively, "Notices") electronically. TeleNav may provide such Notices by posting

them on TeleNav's Website or by downloading such Notices to your wireless device. If you desire to withdraw your consent to receive Notices electronically, you must discontinue your use of the TeleNav Software.

8.4

TeleNav's or your failure to require performance of any provision shall not affect that party's right to require performance at any time thereafter, nor shall a waiver of any breach or default of this Agreement constitute a waiver of any subsequent breach or default or a waiver of the provision itself.

8.5

If any provision herein is held unenforceable, then such provision will be modified to reflect the intention of the parties, and the remaining provisions of this Agreement will remain in full force and effect.

Appendices

8.6

The headings in this Agreement are for convenience of reference only, will not be deemed to be a part of this Agreement, and will not be referred to in connection with the construction or interpretation of this Agreement. As used in this Agreement, the words "include" and "including" and variations thereof, will not be deemed to be terms of limitation, but rather will be deemed to be followed by the words "without limitation".

9. Other Vendors Terms and Conditions

- The Telenav Software utilizes map and other data licensed to Telenav by third party vendors for the benefit of you and other end users. This Agreement includes end-user terms applicable to these companies (included at the end of this Agreement), and thus your use of the Telenav Software is also subject to such terms. You agree to comply with the following additional terms and conditions, which are applicable to Telenav's third party vendor licensors:

9.1 End User Terms Required by HERE North America, LLC

The data ("Data") is provided for your personal, internal use only and not for resale. It is protected by copyright, and is subject to the following terms and conditions which are agreed to by you, on the one hand, and Telenav ("Telenav") and its licensors (including their licensors and suppliers) on the other hand.

© 2013 HERE. All rights reserved.

The Data for areas of Canada includes information taken with permission from Canadian authorities, including: © Her Majesty the Queen in Right of Canada, © Queen's Printer for Ontario, © Canada Post Corporation, GeoBase®, © Department of Natural Resources Canada.

HERE holds a non-exclusive license from the United States Postal Service® to publish and sell ZIP+4® information.

©United States Postal Service® 2014. Prices are not established, controlled or approved by the United States Postal Service®. The following trademarks and registrations are owned by the USPS: United States Postal Service, USPS, and ZIP+4

The Data for Mexico includes certain data from Instituto Nacional de Estadística y Geografía.

9.2 End User Terms Required by NAV2 (Shanghai) Co., Ltd

The data ("Data") is provided for your personal, internal use only and not for resale. It is protected by copyright, and is subject to the following terms and conditions which are agreed to by you, on the one hand, and NAV2 (Shanghai) Co., Ltd ("NAV2") and its licensors (including their licensors and suppliers) on the other hand. 20xx. All rights reserved

Terms and Conditions

Permitted Use. You agree to use this Data together with the Telenav Software solely for the internal business and personal purposes for which you were licensed, and not for service bureau, time-sharing or other similar purposes. Accordingly, but subject to the restrictions set forth in the following paragraphs, you agree not to otherwise reproduce, copy, modify, decompile, disassemble, create any derivative works of, or reverse engineer any portion of this Data, and may not transfer or distribute it in any form, for any purpose, except to the extent permitted by mandatory laws.

Appendices

Restrictions. Except where you have been specifically licensed to do so by Telenav, and without limiting the preceding paragraph, you may not use this Data (a) with any products, systems, or applications installed or otherwise connected to or in communication with vehicles, capable of vehicle navigation, positioning, dispatch, real time route guidance, fleet management or similar applications; or (b) with or in communication with any positioning devices or any mobile or wireless-connected electronic or computer devices, including without limitation cellular phones, palmtop and handheld computers, pagers, and personal digital assistants or PDAs.

Warning. The Data may contain inaccurate or incomplete information due to the passage of time, changing circumstances, sources used and the nature of collecting comprehensive geographic data, any of which may lead to incorrect results.

No Warranty. This Data is provided to you “as is,” and you agree to use it at your own risk. Telenav and its licensors (and their licensors and suppliers) make no guarantees, representations or warranties of any kind, express or implied, arising by law or otherwise, including but not limited to,

content, quality, accuracy, completeness, effectiveness, reliability, fitness for a particular purpose, usefulness, use or results to be obtained from this Data, or that the Data or server will be uninterrupted or error-free.

Disclaimer of Warranty: TELENAV AND ITS LICENSORS (INCLUDING THEIR LICENSORS AND SUPPLIERS) DISCLAIM ANY WARRANTIES, EXPRESS OR IMPLIED, OF QUALITY, PERFORMANCE, MERCHANTABILITY, FITNESS FOR A PARTICULAR PURPOSE OR NON-INFRINGEMENT. Some States, Territories and Countries do not allow certain warranty exclusions, so to that extent the above exclusion may not apply to you.

Disclaimer of Liability: TELENAV AND ITS LICENSORS (INCLUDING THEIR LICENSORS AND SUPPLIERS) SHALL NOT BE LIABLE TO YOU: IN RESPECT OF ANY CLAIM, DEMAND OR ACTION, IRRESPECTIVE OF THE NATURE OF THE CAUSE OF THE CLAIM, DEMAND OR ACTION ALLEGING ANY LOSS, INJURY OR DAMAGES, DIRECT OR INDIRECT, WHICH MAY RESULT FROM THE USE OR POSSESSION OF THE INFORMATION; OR FOR ANY LOSS OF PROFIT, REVENUE, CONTRACTS OR SAVINGS, OR ANY OTHER DIRECT, INDIRECT, INCIDENTAL, SPECIAL OR CONSEQUENTIAL DAMAGES ARISING

OUT OF YOUR USE OF OR INABILITY TO USE THIS INFORMATION, ANY DEFECT IN THE INFORMATION, OR THE BREACH OF THESE TERMS OR CONDITIONS, WHETHER IN AN ACTION IN CONTRACT OR TORT OR BASED ON A WARRANTY, EVEN IF TELENAV OR ITS LICENSORS HAVE BEEN ADVISED OF THE POSSIBILITY OF SUCH DAMAGES. Some States, Territories and Countries do not allow certain liability exclusions or damages limitations, so to that extent the above may not apply to you.

Export Control. You shall not export from anywhere any part of the Data or any direct product thereof except in compliance with, and with all licenses and approvals required under, applicable export laws, rules and regulations, including but not limited to the laws, rules and regulations administered by the Office of Foreign Assets Control of the U.S. Department of Commerce and the Bureau of Industry and Security of the U.S. Department of Commerce. To the extent that any such export laws, rules or regulations prohibit HERE from complying with any of its obligations hereunder to deliver or distribute Data, such failure shall be excused and shall not constitute a breach of this Agreement.

Appendices

Entire Agreement. These terms and conditions constitute the entire agreement between Telenav (and its licensors, including their licensors and suppliers) and you pertaining to the subject matter hereof, and supersedes in their entirety any and all written or oral agreements previously existing between us with respect to such subject matter.

Governing Law. The above terms and conditions shall be governed by the laws of the State of Illinois [insert “Netherlands” where European HERE Data is used], without giving effect to (i) its conflict of laws provisions, or (ii) the United Nations Convention for Contracts for the International Sale of Goods, which is explicitly excluded. You agree to submit to the jurisdiction of the State of Illinois [insert “The Netherlands” where European HERE Data is used] for any and all disputes, claims and actions arising from or in connection with the Data provided to you hereunder.

Government End Users. If the Data is being acquired by or on behalf of the United States government or any other entity seeking or applying rights similar to those customarily claimed by the United States government, this Data is a “commercial item” as that term is defined at 48 C.F.R. (“FAR”) 2.101, is

licensed in accordance with these End-User Terms, and each copy of Data delivered or otherwise furnished shall be marked and embedded as appropriate with the following “Notice of Use,” and shall be treated in accordance with such Notice:

NOTICE OF USE
CONTRACTOR (MANUFACTURER/ SUPPLIER) NAME: HERE
CONTRACTOR (MANUFACTURER/ SUPPLIER) ADDRESS: c/o Nokia, 425 West Randolph Street, Chicago, Illinois 60606
This Data is a commercial item as defined in FAR 2.101 and is subject to these End- User Terms under which this Data was provided.
© 1987 – 2014 HERE – All rights reserved.

If the Contracting Officer, federal government agency, or any federal official refuses to use the legend provided herein, the Contracting Officer, federal government agency, or any federal official must notify HERE prior to seeking additional or alternative rights in the Data.

I. US/Canada Territory

A. United States Data. The End-User Terms for any Application containing Data for the United States shall contain the following notices:

“HERE holds a non-exclusive license from the United States Postal Service® to publish and sell ZIP+4® information.”

“©United States Postal Service® 20XX. Prices are not established, controlled or approved by the United States Postal Service®. The following trademarks and registrations are owned by the USPS: United States Postal Service, USPS, and ZIP+4.”

Appendices

B. Canada Data. The following provisions apply to the Data for Canada, which may include or reflect data from third party licensors (“Third Party Data”), including Her Majesty the Queen in Right of Canada (“Her Majesty”), Canada Post Corporation (“Canada Post”) and the Department of Natural Resources of Canada (“NRCan”):

1. Disclaimer and Limitation: Client agrees that its use of the Third Party Data is subject to the following provisions:

a. Disclaimer: The Third Party Data is licensed on an “as is” basis. The licensors of such data, including Her Majesty, Canada Post and NRCan, make no guarantees, representations or warranties respecting such data, either express or implied, arising by law or otherwise, including but not limited to, effectiveness, completeness, accuracy or fitness for a particular purpose.

b. Limitation on Liability: The Third Party Data licensors, including Her Majesty, Canada Post and NRCan, shall not be liable: (i) in respect of any claim, demand or action, irrespective of the nature of the cause of the claim, demand or action alleging any loss, injury or damages, direct or indirect, which may result from the use or possession of such Data; or (ii) in any way for loss of revenues or contracts, or any other consequential loss of any kind resulting from any defect in the Data.

2. Copyright Notice: In connection with each copy of all or any portion of the Data for the Territory of Canada, Client shall affix in a conspicuous manner the following copyright notice on at least one of: (i) the label for the storage media of the copy; (ii) the packaging for the copy; or (iii) other materials packaged with the copy, such as user manuals or end user license agreements: “This data includes information taken with permission from

Canadian authorities, including © Her Majesty the Queen in Right of Canada, © Queen's Printer for Ontario, © Canada Post Corporation, GeoBase®, © The Department of Natural Resources Canada. All rights reserved.”

3. End-User Terms: Except as otherwise agreed by the parties, in connection with the provision of any portion of the Data for the Territory of Canada to End-Users as may be authorized under the Agreement, Client shall provide such End-Users, in a reasonably conspicuous manner, with terms (set forth with other end user terms required to be provided under the Agreement, or as otherwise may be provided, by Client) which shall include the following provisions on behalf of the Third Party Data licensors, including Her Majesty, Canada Post and NRCan:

The Data may include or reflect data of licensors, including Her Majesty the Queen in the Right of Canada (“Her Majesty”), Canada Post Corporation (“Canada Post”) and the Department of Natural Resources Canada (“NRCan”). Such data is licensed on an “as is” basis. The licensors, including Her Majesty, Canada Post

Appendices

and NRCan, make no guarantees, representations or warranties respecting such data, either express or implied, arising by law or otherwise, including but not limited to, effectiveness, completeness, accuracy or fitness for a particular purpose. The licensors, including Her Majesty, Canada Post and NRCan, shall not be liable in respect of any claim, demand or action, irrespective of the nature of the cause of the claim, demand or action alleging any loss, injury or damages, direct or indirect, which may result from the use or possession of the data or the Data. The licensors, including Her Majesty, Canada Post and NRCan, shall not be liable in any way for loss of revenues or contracts, or any other consequential loss of any kind resulting from any defect in the data or the Data.

End User shall indemnify and save harmless the licensors, including Her Majesty, Canada Post and NRCan, and their officers, employees and agents from and against any claim, demand or action, irrespective of the nature of

the cause of the claim, demand or action, alleging loss, costs, expenses, damages or injuries (including injuries resulting in death) arising out of the use or possession of the data or the Data.

4. Additional Provisions: The terms contained in this Section are in addition to all of the rights and obligations of the parties under the Agreement. To the extent that any of the provisions of this Section are inconsistent with, or conflict with, any other provisions of the Agreement, the provisions of this Section shall prevail.

II. Mexico. The following provision applies to the Data for Mexico, which includes certain data from the Instituto Nacional de Estadística y Geografía (“INEGI”):

A. Any and all copies of the Data and/or packaging containing Data for Mexico shall contain the following notice: “Fuente: INEGI (Instituto Nacional de Estadística y Geografía)”

III. Latin America Territory

A. Third Party Notices. Any and all copies of the Data and/or packaging relating thereto shall include the respective Third Party Notices set forth below and used as described below corresponding to the Territory (or portion thereof) included in such copy:

Territory Notice

Argentina IGN “INSTITUTO GEOGRAFICO NACIONAL ARGENTINO”

Ecuador “INSTITUTO GEOGRAFICO MILITAR DEL ECUADOR AUTORIZACION N° IGM-2011-01- PCO-01 DEL 25 DE ENERO DE 2011”

Appendices

“source: © IGN 2009 - BD TOPO ®”

Guadeloupe,
French Guiana
and
Martinique
Mexico

“Fuente: INEGI (Instituto Nacional de Estadística y Geografía)”

Country Notice

Jordan “© Royal Jordanian Geographic Centre”. The foregoing notice requirement for Jordan Data is a material term of the Agreement. If Client or any of its permitted sublicensees (if any) fail to meet such requirement, HERE shall have the right to terminate Client’s license with respect to the Jordan Data.

B. Jordan Data. Client and its permitted sublicensees (if any) are restricted from licensing and/or otherwise distributing HERE’s database for the country of Jordan (“Jordan Data”) for use in Enterprise Applications to (i) non-Jordanian entities for use of the Jordan Data solely in Jordan or (ii) Jordan-based customers. In addition, Client, its permitted sublicensees (if any) and End-Users are restricted from using the Jordan Data in Enterprise Applications if such party is (i) a non-Jordanian entity using the Jordan Data solely in Jordan or (ii) a Jordan-based customer. For purposes of the foregoing, “Enterprise Applications”

shall mean Geomarketing applications, GIS applications, mobile business asset management applications, call center applications, telematics applications, public organization Internet applications or for providing geocoding services.

V. Europe Territory

A. Use of Certain Traffic Codes in Europe

1. General Restrictions Applicable to Traffic Codes. Client acknowledges and agrees that in certain countries of the Europe Territory, Client will need to obtain rights directly from third party RDS-TMC code providers to receive and use the Traffic Codes in the Data and to deliver to End-Users Transactions in any way derived from or based on such Traffic Codes. For such countries, HERE shall deliver the Data incorporating Traffic Codes to Client only after receiving certification from Client of its having obtained such rights.

IV. Middle East Territory

A. Third Party Notices. Any and all copies of the Data and/or packaging relating thereto shall include the respective Third Party Notices set forth below and used as described below corresponding to the Territory (or portion thereof) included in such copy:

Appendices

2. Display of Third Party Rights Legends for Belgium. Client shall, for each Transaction that uses Traffic Codes for Belgium, provide the following notice to the End-User: "Traffic Codes for Belgium are provided by the Ministerie van de Vlaamse Gemeenschap and the Ministère de l'Équipement et des Transports."

B. Paper Maps. With respect to any license granted to Client relating to making, selling or distributing paper maps (i.e., a map fixed on a paper or paper-like medium): (a) such license with respect to Data for the Territory of Great Britain is conditioned on Client's entering into and complying with a separate written agreement with the Ordnance Survey ("OS") to create and sell paper maps, Client's paying to the OS any and all applicable paper map royalties, and Client's complying with the OS copyright notice requirements; (b) such license for selling or otherwise distributing for charge with respect to Data for the Territory of Czech Republic is conditioned on Client's obtaining prior written consent from Kartografie a.s.; (c) such license for selling or distributing with respect to Data for the Territory of Switzerland is conditioned on Client's obtaining a permit from

Bundesamt für Landestopografie of Switzerland; (d) Client is restricted from using Data for the Territory of France to create paper maps with a scale between 1:5,000 and 1:250,000; and (e) Client is restricted from using any Data to create, sell or distribute paper maps that are the same or substantially similar, in terms of data content and specific use of color, symbols and scale, to paper maps published by the European national mapping agencies, including without limitation, Landvermessungämter of Germany, Topografische Dienst of the Netherlands, Nationaal Geografisch Instituut of Belgium, Bundesamt für Landestopografie of Switzerland, Bundesamt für Eich-und Vermessungswesen of Austria, and the National Land Survey of Sweden.

C. OS Enforcement. Without limiting Section IV(B) above, with respect to Data for the Territory of Great Britain, Client acknowledges and agrees that the Ordnance Survey ("OS") may bring a direct action against Client to enforce compliance with the OS copyright notice (see Section IV(D) below) and paper map requirements (see Section IV(B) above) contained in this Agreement.

D. Third Party Notices. Any and all copies of the Data and/or packaging relating thereto shall include the respective Third Party Notices set forth below and used as described below corresponding to the Territory (or portion thereof) included in such copy:

Country(ies)	Notice
Austria	"© Bundesamt für Eich- und Vermessungswesen"
Croatia Cyprus, Estonia, Latvia, Lithuania, Moldova, Poland, Slovenia and/or Ukraine	"© EuroGeographics"
France	"source: © IGN 2009 – BD TOPO ®"
Germany	"Die Grundlagendaten wurden mit Genehmigung der zuständigen Behörden entnommen"

Appendices

Great Britain	“Contains Ordnance Survey data © Crown copyright and database right 2010 Contains Royal Mail data © Royal Mail copyright and database right 2010”
Greece	“Copyright Geomatics Ltd.”
Hungary	“Copyright © 2003; Top-Map Ltd.”
Italy	“La Banca Dati Italiana è stata prodotta usando quale riferimento anche cartografia numerica ed al tratto prodotta e fornita dalla Regione Toscana.”
Norway	“Copyright © 2000; Norwegian Mapping Authority”
Portugal	“Source: IgeoE – Portugal”
Spain	“Información geográfica propiedad del CNIG”

Sweden	“Based upon electronic data © National Land Survey Sweden.”
Switzerland	“Topografische Grundlage: © Bundesamt für Landestopographie.
E. Respective Country Distribution.	Client acknowledges that HERE has not received approvals to distribute map data for the following countries in such respective countries: Albania, Belarus, Kyrgyzstan, Moldova and Uzbekistan. HERE may update such list from time to time. The license rights granted to Client under this TL with respect to the Data for such countries are contingent upon Client’s compliance with all applicable laws and regulations, including, without limitation, any required licenses or approvals to distribute the Application incorporating such Data in such respective countries.

VI. Australia Territory

A. Third Party Notices. Any and all copies of the Data and/or packaging relating thereto shall include the respective Third Party Notices set forth below and used as described below corresponding to the Territory (or portion thereof) included in such copy:

Copyright. Based on data provided under license from PSMA Australia Limited (www.pasma.com.au). Product incorporates data which is © 20XX Telstra Corporation Limited, GM Holden Limited, Intelomatics Australia Pty Ltd and Continental Pty Ltd.

B. Third Party Notices for Australia. In addition to the foregoing, the End-User Terms for any Application containing RDS-TMC Traffic Codes for Australia shall contain the following notice: “Product incorporates traffic location codes which is © 20XX Telstra Corporation Limited and its licensors.”

Appendices

AT&T Vehicle Network Carrier Telematics Disclosure

END USER FOR PURPOSES OF THIS SECTION MEANS YOU AND YOUR HEIRS, EXECUTORS, LEGAL PERSONAL REPRESENTATIVES AND PERMITTED ASSIGNS. FOR PURPOSES OF THIS SECTION “UNDERLYING WIRELESS SERVICE CARRIER” INCLUDES ITS AFFILIATES AND CONTRACTORS AND THEIR RESPECTIVE OFFICERS, DIRECTORS, EMPLOYEES, SUCCESSORS AND ASSIGNS. END USER HAS NO CONTRACTUAL RELATIONSHIP WITH THE UNDERLYING WIRELESS SERVICE CARRIER AND END USER IS NOT A THIRD PARTY BENEFICIARY OF ANY AGREEMENT BETWEEN FORD AND UNDERLYING CARRIER. END USER UNDERSTANDS AND AGREES THAT THE UNDERLYING CARRIER HAS NO LEGAL, EQUITABLE, OR OTHER LIABILITY OF ANY KIND TO END USER. IN ANY EVENT, REGARDLESS OF THE FORM OF THE ACTION, WHETHER FOR BREACH OF CONTRACT, WARRANTY, NEGLIGENCE, STRICT LIABILITY IN TORT OR OTHERWISE, END USER’S EXCLUSIVE REMEDY FOR CLAIMS ARISING IN ANY WAY IN CONNECTION WITH THIS AGREEMENT, FOR ANY CAUSE WHATSOEVER, INCLUDING BUT NOT LIMITED TO ANY FAILURE OR DISRUPTION OF SERVICE PROVIDED

HEREUNDER, IS LIMITED TO PAYMENT OF DAMAGES IN AN AMOUNT NOT TO EXCEED THE AMOUNT PAID BY END USER FOR THE SERVICES DURING THE TWO-MONTH PERIOD PRECEDING THE DATE THE CLAIM AROSE.

(ii) END USER AGREES TO INDEMNIFY AND HOLD HARMLESS THE UNDERLYING WIRELESS SERVICE CARRIER AND ITS OFFICERS, EMPLOYEES, AND AGENTS AGAINST ANY AND ALL CLAIMS, INCLUDING WITHOUT LIMITATION CLAIMS FOR LIBEL, SLANDER, OR ANY PROPERTY DAMAGE, PERSONAL INJURY OR DEATH, ARISING IN ANY WAY, DIRECTLY OR INDIRECTLY, IN CONNECTION WITH THIS AGREEMENT OR THE USE, FAILURE TO USE, OR INABILITY TO USE THE DEVICE EXCEPT WHERE THE CLAIMS RESULT FROM THE UNDERLYING CARRIER’S GROSS NEGLIGENCE OR WILLFUL MISCONDUCT. THIS INDEMNITY WILL SURVIVE THE TERMINATION OF THE AGREEMENT.

(iii) END USER HAS NO PROPERTY RIGHT IN ANY NUMBER ASSIGNED TO THE DEVICE.

(iv) END USER UNDERSTANDS THAT FORD AND THE UNDERLYING CARRIER CANNOT GUARANTEE THE SECURITY OF WIRELESS TRANSMISSIONS, AND WILL NOT BE LIABLE FOR ANY LACK OF SECURITY RELATING TO THE USE OF THE SERVICES

THE SERVICE IS FOR [END USER’S] USE ONLY AND END USER MAY NOT RESELL THE SERVICE TO ANY OTHER PARTY. END USER UNDERSTANDS THAT THE UNDERLYING CARRIER DOES NOT GUARANTEE ANY END USER UNINTERRUPTED SERVICE OR COVERAGE. THE UNDERLYING CARRIER DOES NOT WARRANT THAT END USERS CAN OR WILL BE LOCATED USING THE SERVICE. THE UNDERLYING CARRIER MAKES NO WARRANTY, EXPRESS OR IMPLIED, OF MERCHANTABILITY OR FITNESS FOR A PARTICULAR PURPOSE, SUITABILITY, OR PERFORMANCE REGARDING ANY SERVICES OR GOODS, AND IN NO EVENT SHALL AT&T BE LIABLE, WHETHER OR NOT DUE TO ITS OWN NEGLIGENCE, FOR ANY: (A) ACT OR OMISSION OF A THIRD PARTY; (B) MISTAKES, OMISSIONS, INTERRUPTIONS, ERRORS, FAILURES TO TRANSMIT, DELAYS, OR DEFECTS IN THE SERVICE PROVIDED BY OR THROUGH THE UNDERLYING CARRIER; (C) DAMAGE OR INJURY CAUSED BY SUSPENSION OR TERMINATION BY THE

Appendices

UNDERLYING CARRIER; OR (D) DAMAGE OR INJURY CAUSED BY A FAILURE OR DELAY IN CONNECTING A CALL TO ANY ENTITY, INCLUDING 911 OR ANY OTHER EMERGENCY SERVICE, TO THE FULL EXTENT ALLOWED BY LAW, THE END USER RELEASES, INDEMNIFIES AND HOLDS THE UNDERLYING CARRIER HARMLESS FROM AND AGAINST ANY AND ALL CLAIMS OF ANY PERSON OR ENTITY FOR DAMAGES OF ANY NATURE ARISING IN ANY WAY FROM OR RELATING TO, DIRECTLY OR INDIRECTLY, SERVICES PROVIDED BY THE UNDERLYING CARRIER OR ANY PERSON'S USE THEREOF, INCLUDING CLAIMS ARISING IN WHOLE OR IN PART FROM THE ALLEGED NEGLIGENCE OF THE UNDERLYING CARRIER.

VII. China Territory

Personal Use Only

You agree to use this Data together with [insert name of Client Application] for the solely personal, non-commercial purposes for which you were licensed, and not for service bureau, time-sharing or other similar purposes. Accordingly, but subject to the restrictions set forth in the following paragraphs, you may copy this Data only as necessary for your personal use to (i) view it, and (ii) save it, provided that you do not

remove any copyright notices that appear and do not modify the Data in any way. You agree not to otherwise reproduce, copy, modify, decompile, disassemble or reverse engineer any portion of this Data, and may not transfer or distribute it in any form, for any purpose, except to the extent permitted by mandatory laws.

Restrictions

Except where you have been specifically licensed to do so by NAV2, and without limiting the preceding paragraph, you may not (a) use this Data with any products, systems, or applications installed or otherwise connected to or in communication with vehicles, capable of vehicle navigation, positioning, dispatch, real time route guidance, fleet management or similar applications; or (b) with or in communication with any positioning devices or any mobile or wireless-connected electronic or computer devices, including without limitation cellular phones, palmtop and handheld computers, pagers, and personal digital assistants or PDAs. You agree to cease using this Data if you fail to comply with these terms and conditions.

Limited Warranty

NAV2 warrants that (a) the Data will perform substantially in accordance with the accompanying written materials for a period of ninety (90) days from the date of receipt, and (b) any support services provided by NAV2 shall be substantially as described in applicable written materials provided to you by NAV2, and NAV2's support engineers will make commercially reasonable efforts to solve any problem issues.

Customer Remedies

NAV2 and its suppliers' entire liability and your exclusive remedy shall be, at NAV2's sole discretion, either (a) return of the price paid, if any, or (b) repair or replacement of the Data that do not meet NAV2's Limited Warranty and that are returned to NAV2 with a copy of your receipt. This Limited Warranty is void if failure of the Data has resulted from accident, abuse, or misapplication. Any replacement Data will be warranted for the remainder of the original warranty period or thirty (30) days, whichever is longer. Neither these remedies nor any product support services offered by NAV2 are available without proof of purchase from an authorized international source.

Appendices

No Other Warranty:

EXCEPT FOR THE LIMITED WARRANTY SET FORTH ABOVE AND TO THE EXTENT PERMITTED BY APPLICABLE LAW, NAV2 AND ITS LICENSORS (INCLUDING THEIR LICENSORS AND SUPPLIERS) DISCLAIM ANY WARRANTIES, EXPRESS OR IMPLIED, OF QUALITY, PERFORMANCE, MERCHANTABILITY, FITNESS FOR A PARTICULAR PURPOSE, OWNERSHIP OR NON-INFRINGEMENT. Certain warranty exclusions may not be permitted under applicable law, so to that extent the above exclusion may not apply to you.

Limited Liability:

TO THE EXTENT PERMITTED BY APPLICABLE LAW, NAV2 AND ITS LICENSORS (INCLUDING THEIR LICENSORS AND SUPPLIERS) SHALL NOT BE LIABLE TO YOU: IN RESPECT OF ANY CLAIM, DEMAND OR ACTION, IRRESPECTIVE OF THE NATURE OF THE CAUSE OF THE CLAIM, DEMAND OR ACTION ALLEGING ANY LOSS, INJURY OR DAMAGES, DIRECT OR INDIRECT, WHICH MAY RESULT FROM THE USE OR POSSESSION OF THE INFORMATION; OR FOR ANY LOSS OF PROFIT, REVENUE, CONTRACTS OR SAVINGS, OR ANY OTHER DIRECT, INDIRECT, INCIDENTAL, SPECIAL OR CONSEQUENTIAL DAMAGES ARISING

OUT OF YOUR USE OF OR INABILITY TO USE THIS INFORMATION, ANY DEFECT IN THE INFORMATION, OR THE BREACH OF THESE TERMS OR CONDITIONS, WHETHER IN AN ACTION IN CONTRACT OR TORT OR BASED ON A WARRANTY, EVEN IF NAV2 OR ITS LICENSORS HAVE BEEN ADVISED OF THE POSSIBILITY OF SUCH DAMAGES. UNDER NO CIRCUMSTANCES SHALL NAV2'S OR ITS SUPPLIERS' LIABILITY HEREUNDER EXCEED THE PRICE PAID. Certain liability exclusions may not be permitted under applicable law, so to that extent the above exclusion may not apply to you.

Export Control

You agree not to export to anywhere any part of the Data provided to you or any direct product thereof except in compliance with, and with all licenses and approvals required under, applicable export laws, rules and regulations.

IP Protection

The Data are owned by NAV2 or its suppliers and are protected by applicable copyright and other intellectual property law and treaties. The Data are provided solely on the basis of a license to use, not sale.

Entire Agreement

These terms and conditions constitute the entire agreement between NAV2 (and its licensors, including their licensors and suppliers) and you pertaining to the subject matter hereof, and supersedes in their entirety any and all written or oral agreements previously existing between us with respect to such subject matter.

Governing Law.

The above terms and conditions shall be governed by the laws of the People's Republic of China, without giving effect to (i) its conflict of laws provisions, or (ii) the United Nations Convention for Contracts for the International Sale of Goods, which is explicitly excluded. Any dispute arising from or in connection with the Data provided to you hereunder shall be submitted to the Shanghai International Economic and Trade Arbitration Commission for arbitration.

Gracenote® Copyright

CD and music-related data from Gracenote, Inc., copyright©

Appendices

2000-2007 Gracenote. Gracenote Software, copyright © 2000-2007 Gracenote. This product and service may practice one or more of the following U.S. Patents 5,987,525; 6,061,680; 6,154,773; 6,161,132; 6,230,192; 6,230,207; 6,240,459; 6,330,593 and other patents issued or pending. Some services supplied under license from Open Globe, Inc. for U.S. Patent 6,304,523.

Gracenote and CDDB are registered trademarks of Gracenote. The Gracenote logo and logotype, and the "Powered by Gracenote™" logo are trademarks of Gracenote.

Gracenote® End User License Agreement (EULA)

This device contains software from Gracenote, Inc. of 2000 Powell Street Emeryville, California 94608 ("Gracenote").

The software from Gracenote (the "Gracenote Software") enables this device to do disc and music file identification and obtain music-related information, including name, artist, track, and title information ("Gracenote Data") from online servers ("Gracenote Servers"), and to perform other functions. You may use Gracenote Data only by means of the intended End User functions of this device. This device may contain

content belonging to Gracenote's providers. If so, all of the restrictions set forth herein with respect to Gracenote Data shall also apply to such content and such content providers shall be entitled to all of the benefits and protections set forth herein that are available to Gracenote. You agree that you will use the content from Gracenote ("Gracenote Content"), Gracenote Data, the Gracenote Software, and Gracenote Servers for your own personal, non-commercial use only. You agree not to assign, copy, transfer or transmit the Gracenote Content, Gracenote Software or any Gracenote Data (except in a Tag associated with a music file) to any third party. YOU AGREE NOT TO USE OR EXPLOIT GRACENOTE CONTENT, GRACENOTE DATA, THE GRACENOTE SOFTWARE, OR GRACENOTE SERVERS, EXCEPT AS EXPRESSLY PERMITTED HEREIN.

You agree that your non-exclusive licenses to use the Gracenote Content, Gracenote Data, the Gracenote Software, and Gracenote Servers will terminate if you violate these restrictions. If your licenses terminate, you agree to cease any and all use of the Gracenote Content, Gracenote Data, the Gracenote Software, and Gracenote Servers.

Gracenote, respectively, reserve all rights in Gracenote Data, the Gracenote Software, and the Gracenote Servers and Gracenote Content, including all ownership rights. Under no circumstances will either Gracenote become liable for any payment to you for any information that you provide, including any copyrighted material or music file information. You agree that Gracenote may enforce its respective rights, collectively or separately, under this agreement against you, directly in each company's own name.

Gracenote uses a unique identifier to track queries for statistical purposes. The purpose of a randomly assigned numeric identifier is to allow Gracenote to count queries without knowing anything about who you are. For more information, see the web page at www.gracenote.com for the Gracenote Privacy Policy.

THE GRACENOTE SOFTWARE, EACH ITEM OF GRACENOTE DATA AND THE GRACENOTE CONTENT ARE LICENSED TO YOU "AS IS". NEITHER GRACENOTE MAKES ANY REPRESENTATIONS OR WARRANTIES, EXPRESS OR IMPLIED, REGARDING THE ACCURACY OF ANY GRACENOTE DATA FROM THE GRACENOTE SERVERS OR GRACENOTE CONTENT. GRACENOTE COLLECTIVELY AND SEPARATELY RESERVE THE RIGHT TO DELETE DATA AND/OR

Appendices

CONTENT FROM THE COMPANIES' RESPECTIVE SERVERS OR, IN THE CASE OF GRACENOTE, CHANGE DATA CATEGORIES FOR ANY CAUSE THAT GRACENOTE DEEMS SUFFICIENT. NO WARRANTY IS MADE THAT EITHER GRACENOTE CONTENT OR THE GRACENOTE SOFTWARE OR GRACENOTE SERVERS ARE ERROR-FREE OR THAT THE FUNCTIONING OF THE GRACENOTE SOFTWARE OR GRACENOTE SERVERS WILL BE UNINTERRUPTED. GRACENOTE IS NOT OBLIGATED TO PROVIDE YOU WITH ANY ENHANCED OR ADDITIONAL DATA TYPES THAT GRACENOTE MAY CHOOSE TO PROVIDE IN THE FUTURE AND IS FREE TO DISCONTINUE ITS ONLINE SERVICES AT ANY TIME. GRACENOTE DISCLAIMS ALL WARRANTIES EXPRESS OR IMPLIED, INCLUDING, BUT NOT LIMITED TO, IMPLIED WARRANTIES OF MERCHANTABILITY, FITNESS FOR A PARTICULAR PURPOSE, TITLE, AND NON-INFRINGEMENT. NEITHER GRACENOTE WARRANTS THE RESULTS THAT WILL BE OBTAINED BY YOUR USE OF THE GRACENOTE SOFTWARE OR ANY GRACENOTE SERVER. IN NO CASE WILL GRACENOTE BE LIABLE FOR ANY CONSEQUENTIAL OR INCIDENTAL DAMAGES OR FOR ANY LOST PROFITS OR LOST REVENUES FOR ANY REASON WHATSOEVER. © Gracenote 2007.

Radio Frequency Statement

FCC ID: ACJ-SYNCG3-L

IC: 216B-SYNCG3-L

This device complies with Part 15 of the FCC Rules and with RSS-210 of Industry Canada. Operation is subject to the following two conditions:

- (1)** This device may not cause harmful interference, and
- (2)** this device must accept any interference received, including interference that may cause undesired operation.

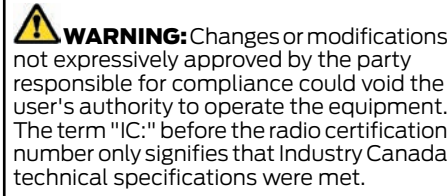

The antenna used for this transmitter must not be co-located or operating in conjunction with any other antenna or transmitter.

Taiwan Territory

Note: In accordance with the management approach of low-power radio wave radiation motors:

Article 12: For approved and certified low-power radiation motor models, companies, firms or users must not alter the frequency, increase the power or change the characteristics and functions of the original design without authorization.

Article 14: The usage of low-power radio-frequency motors must not affect aviation safety and interfere with legal telecommunications. Should interference be detected, immediately stop using the device and only resume usage after ensuring that there is no longer any interference. For the legal telecommunication and wireless telecommunication of the telco, the low-power radio frequency motor must be able to tolerate legal limits of interference from telecommunication, industrial, scientific and radio wave equipment.

Appendices

SUNA TRAFFIC CHANNEL – TERMS AND CONDITIONS

By activating, using and/or accessing the SUNA Traffic Channel, SUNA Predictive or other content or material provided by Intelematics (together, **SUNA Products and/or Services**), you must accept certain terms and conditions. The following is a brief summary of the terms and conditions that apply to you. To view the full terms and conditions relevant to your use of the SUNA Products and/or Services, please consult:

Website
www.sunatraffic.com.au/termsandconditions/

1. Acceptance

By using SUNA Products and/or Services, you will be deemed to have accepted and agreed to be bound by the terms and conditions fully detailed at:

Website
www.sunatraffic.com.au/termsandconditions/

2. Intellectual Property

SUNA Products and/or Services are for your personal use. You may not record, or retransmit the content, nor use the content in association with any other traffic information or route guidance service or device not approved by Intelematics. You obtain no right of ownership in any Intellectual Property Rights (including copyright) in the data that is used to provide SUNA Products and/or Services.

3. Appropriate Use

SUNA Products and/or Services are intended as an aid to personal motoring and travel planning, and do not provide comprehensive or accurate information on all occasions. On occasions, you may experience additional delay as a result of using SUNA Products and/or Services. You acknowledge that it is not intended, or suitable, for use in applications where time of arrival or driving directions may impact the safety of the public or yourself.

4. Use of SUNA Products and Services while driving

You, and other authorised drivers of the vehicle in which SUNA Products and/or Services are available or installed and active, remain at all times responsible for observing all relevant laws and codes of safe driving. In particular, you agree to only actively operate SUNA Products and/or Services when the Vehicle is at a complete stop and it is safe to do so.

5. Service Continuity and Reception of the SUNA Traffic Channel

We will use reasonable endeavours to provide the SUNA Traffic Channel 24 hours a day, 365 days a year. The SUNA Traffic Channel may occasionally be unavailable for technical reasons or for planned maintenance. We will try to perform maintenance at times when congestion is light. We reserve the right to withdraw SUNA Products and/or Services at any time.

Also, we cannot assure the uninterrupted reception of the SUNA Traffic Channel RDS-TMC signal at any particular location.

6. Limitation of Liability

Appendices

Neither Intelematics (nor its suppliers or the manufacturer of your device (the “**Suppliers**”)) shall be liable to you or to any third party for any damages either direct, indirect, incidental, consequential or otherwise arising out of the use of or inability to use SUNA Products and/or Services even if Intelematics or a Supplier has been advised of the possibility of such damages. You also acknowledge that the neither Intelematics nor any Supplier guarantees nor make any warranties that relate to the availability, accuracy or completeness of SUNA Products and/or Services, and to the extent which it is lawful to do so, both Intelematics and each Supplier excludes any warranties which might otherwise be implied by any State or Federal legislation in relation to SUNA Products and/or Services.

7. Please Note

Great care has been taken in preparing this manual. Constant product development may mean that some information is not entirely up-to-date. The information in this document is subject to change without notice.

DECLARATION OF CONFORMITY

Your vehicle could have components that transmit and receive radio waves and are therefore subject to government regulation.

These components must accept any interference received, including interference that could cause undesired operation. For certification labels and declarations of conformity, visit www.wirelessconformity.ford.com.

Index

- A**
- A/C
See: Climate Control - Vehicles With: Automatic Temperature Control.....139
See: Climate Control - Vehicles With: Manual Temperature Control.....142
- About This Manual.....11
- ABS
See: Brakes.....203
- ABS driving hints
See: Hints on Driving With Anti-Lock Brakes.....203
- Accessories
See: Replacement Parts Recommendation.....14
- ACC
See: Using Adaptive Cruise Control - Vehicles With: Adaptive Cruise Control.....221
See: Using Adaptive Cruise Control - Vehicles With: Adaptive Cruise Control With Stop and Go.....232
- Acknowledgments.....11
- Active Park Assist.....214
Using Active Park Assist.....214
- Adding Washer Fluid.....86
- Adjusting the Exterior Mirrors.....103
- Adjusting the Interior Mirror.....102
- Adjusting the Steering Wheel.....79
- Air Conditioning
See: Climate Control - Vehicles With: Automatic Temperature Control.....139
See: Climate Control - Vehicles With: Manual Temperature Control.....142
- Alarm
See: Anti-Theft Alarm - Vehicles With: Integral Battery.....75
See: Anti-Theft Alarm - Vehicles With: Perimeter Alarm.....76
- AM/FM Radio - Vehicles With: SYNC 2.5.....406
Using the Radio.....406
- Anti-Theft Alarm - Vehicles With: Integral Battery.....75
Arming the Alarm.....76
Battery Back-up Sounder.....75
Disarming the Alarm.....76
Full and Reduced Guard.....76
Inclination Sensors.....75
Interior Sensors.....75
Perimeter Alarm.....75
Triggering the Alarm.....75
- Anti-Theft Alarm - Vehicles With: Perimeter Alarm.....76
Arming the Alarm.....76
Disarming the Alarm.....77
- Appendices.....452
- Apps.....437
Using Apps on an Android Device.....438
Using Apps on an iOS Device.....437
- Using Mobile Navigation on an Android Device.....438
- Apps - Vehicles With: SYNC 2.5.....409
Apps Troubleshooting.....411
Using Android Auto.....410
Using Apple CarPlay.....409
Using Apps on an Android Device.....410
Using Apps on an iOS Device.....409
- Audible Warnings and Indicators.....114
- Airbag Secondary Warning.....114
- Automatic Transmission.....114
- Auto-Start-Stop Warning.....114
- Door Ajar.....114
- Exterior Lamps On.....114
- Key Outside Vehicle.....115
- Low Fuel Reminder.....114
- Over Speed Warning.....115
- Parking Brake On.....115
- Seatbelt Reminder.....115
- Audio System.....404
- Audio System - Troubleshooting - Vehicles With: SYNC 2.5.....413
Master Reset.....414
Resetting the System.....413
Updating the System.....413
- Audio Unit Clock and Date Displays - Vehicles With: SYNC 2.5.....407
- Audio Unit - Vehicles With: SYNC 2.5.....405
Adjusting the Volume.....405
Changing Radio Stations.....405
Pausing or Playing Media.....405

Index

Seek Down and Previous Track Button.....	405	Switching Automatic Engine Stop On and Off.....	165	Manual (M).....	199
Seek Up and Next Track Button.....	405	Automatic High Beam Control.....	92	Neutral (N).....	199
Sound Settings.....	405	About Automatic High Beam Control.....	92	Park (P).....	199
Switching the Audio Unit On and Off.....	405	Automatic High Beam Control Information Messages.....	93	Reverse (R).....	199
Switching the Screen On and Off.....	405	Automatic High Beam Indicator.....	93	Automatic Transmission	
Audio Unit - Vehicles With: SYNC 3.....	404	Overriding Automatic High Beam Control.....	93	Precautions.....	199
Adjusting the Volume.....	404	Switching Automatic High Beam Control On or Off.....	93	Automatic Transmission Shift Indicators - Vehicles With: Paddle Shifters.....	200
Changing Radio Stations.....	404	Automatic Transmission Audible Warnings.....	202	Automatic Transmission - Troubleshooting.....	202
Pausing or Playing Media.....	404	Transmission Not in Park (P) Audible Warning.....	202	Automatic Transmission - Information Messages.....	202
Seek Down and Previous Track Button.....	404	Automatic Transmission.....	199	Autorelock.....	69
Seek Up and Next Track Button.....	404	Automatic Transmission Positions.....	199	How Does Autorelock Work.....	69
Sound Settings.....	404	Automatic Transmission - Troubleshooting.....	202	Auto-Start-Stop Audible Warning.....	176
Switching the Audio Unit On and Off.....	404	Brake Shift Interlock.....	201	Auto-Start-Stop - Automatic Transmission.....	172
Switching the Screen On and Off.....	404	Manually Shifting Gears.....	200	Information Messages.....	174
Auto-Dimming Interior Mirror.....	102	Automatic Transmission Position Indicators - 7-Speed Automatic Transmission, Vehicles With: Paddle Shifters.....	200	Principle of Operation.....	172
Auto-Dimming Interior Mirror Precautions.....	102	Automatic Transmission Position Indicators - 7-Speed Automatic Transmission, Vehicles Without: Paddle Shifters.....	200	Replacing the Battery.....	174
What Is the Auto-Dimming Interior Mirror.....	102	Automatic Transmission Positions.....	199	Switching the System On and Off.....	173
Autolamps.....	91	Drive (D).....	199	Using Auto-Start-Stop.....	173
Adjusting the Period of Time That the Headlamps Remain On.....	91	Low (L).....	199	Auto-Start-Stop.....	175
Autolock.....	68			Auto-Start-Stop Settings.....	175
Autolock Requirements.....	68			Auto-Start-Stop - Troubleshooting.....	177
Switching Autolock On and Off.....	68			Auto-Start-Stop Indicators.....	176
What Is Autolock.....	68			Auto-Start-Stop - Manual Transmission, Excluding: Mild Hybrid Electric Vehicle (MHEV).....	171
Automatic Crash Notification System.....	50			Auto-Start-Stop Warning.....	172
Automatic Engine Stop.....	165			Information Messages.....	172
How Does Automatic Engine Stop Work.....	165			Principle of Operation.....	171
Overriding Automatic Engine Stop.....	166				

Index

Replacing the Battery.....	172	Blind Spot Information System Sensors.....	252	Engine.....	381
Switching the System On and Off.....	171	Switching the Blind Spot Information System On and Off.....	253	Fuel Tank.....	382
Using Auto-Start-Stop.....	171	Using the Blind Spot Information System.....	252	Washer Reservoir.....	382
Auto-Start-Stop Precautions.....	175	BLIS See: Blind Spot Information System.....	252	Capacities and Specifications - 1.5L Duratorq-TDCi Diesel.....	383
Auto-Start-Stop Settings.....	175	Bonnet Lock See: Opening and Closing the Hood.....	304	Brake System.....	385
Setting the Engine Stop Speed.....	175	Brake Fluid Check.....	321	Engine.....	383
Auto-Start-Stop – Troubleshooting.....	177	Brakes.....	203	Fuel Tank.....	385
Auto-Start-Stop – Frequently Asked Questions.....	178	General Information.....	203	Washer Reservoir.....	385
Auto-Start-Stop – Information Messages.....	177	Brake Shift Interlock.....	201	Capacities and Specifications - 1.5L EcoBoost™.....	386
Autounlock.....	68	Brake Shift Interlock Precautions.....	201	Brake System.....	388
Autounlock Requirements.....	68	Using Brake Shift Interlock.....	201	Engine.....	386
Switching Autounlock On and Off.....	68	What Is Brake Shift Interlock.....	201	Fuel Tank.....	388
What Is Autounlock.....	68	Breaking-In.....	282	Washer Reservoir.....	388
Autowipers.....	82	Brakes and Clutch.....	282	Capacities and Specifications.....	375
Adjusting the Sensitivity of the Rain Sensor.....	83	Tires.....	282	Catalytic Converter.....	191
Autowiper Settings.....	82	Bulb Specification Chart.....	389	On-Board Diagnostics System.....	191
Switching Autowipers On and Off.....	82	C		Center Console - 7-Speed Automatic Transmission, LHD, Vehicles With: Active Park Assist/Front Parking Aid/Rear Parking Aid, Excluding: Liquefied Petroleum Gas (LPG).....	30
What Is Autowipers.....	82	Capacities and Specifications - 1.0L EcoBoost™.....	378	Center Console - 7-Speed Automatic Transmission, LHD, Vehicles Without: Active Park Assist/Front Parking Aid/Rear Parking Aid, Excluding: Liquefied Petroleum Gas (LPG).....	29
Auxiliary Power Points.....	154	Brake System.....	380		
B		Engine.....	378		
Battery		Fuel Tank.....	379		
See: Changing the 12V Battery.....	322	Washer Reservoir.....	379		
Blind Spot Information System.....	252	Capacities and Specifications - 1.1L Duratec.....	380		
Blind Spot Information System Indicator.....	253	Brake System.....	383		
Blind Spot Information System Information Messages.....	253				

Index

Center Console - 7-Speed Automatic Transmission, RHD, Vehicles With: Active Park Assist/Front Parking Aid/Rear Parking Aid, Excluding: Liquefied Petroleum Gas (LPG).....	31
Center Console - 7-Speed Automatic Transmission, RHD, Vehicles Without: Active Park Assist/Front Parking Aid/Rear Parking Aid, Excluding: Liquefied Petroleum Gas (LPG).....	31
Center Console - Liquefied Petroleum Gas (LPG), Vehicles With: Active Park Assist/Front Parking Aid/Rear Parking Aid.....	26
Center Console - Liquefied Petroleum Gas (LPG), Vehicles Without: Active Park Assist/Front Parking Aid.....	26
Center Console - Manual Transmission, LHD, Vehicles With: Active Park Assist/Front Parking Aid/Rear Parking Aid, Excluding: Liquefied Petroleum Gas (LPG).....	27
Center Console - Manual Transmission, LHD, Vehicles Without: Active Park Assist/Front Parking Aid/Rear Parking Aid, Excluding: Liquefied Petroleum Gas (LPG).....	27
Center Console - Manual Transmission, RHD, Vehicles With: Active Park Assist/Front Parking Aid/Rear Parking Aid, Excluding: Liquefied Petroleum Gas (LPG).....	29
Center Console - Manual Transmission, RHD, Vehicles Without: Active Park Assist/Front Parking Aid/Rear Parking Aid, Excluding: Liquefied Petroleum Gas (LPG).....	28
Changing a Bulb.....	327
Front Fog Lamp.....	330
Headlamp.....	327
High Mounted Stoplamp.....	333
License Plate Lamp.....	333
Rear Fog Lamp.....	333
Rear Lamp.....	332
Side Direction Indicator.....	331
Changing a Fuse.....	302
Engine Compartment Fuse Box.....	302
Fuses Types.....	303
General Information.....	302
Passenger Compartment Fuse Box.....	302
Changing a Road Wheel - Vehicles With:	
Spare Wheel.....	345
Installing a Road Wheel.....	352
Jacking and Lifting Points.....	348
Removing a Road Wheel.....	351
Removing the Wheel Trim.....	350
Vehicle Jack.....	347
Vehicles With a Spare Wheel.....	345
Vehicles Without a Spare Wheel.....	347
Changing the 12V Battery.....	322
Remove and Reinstall the Battery.....	323
Changing the Front Wiper Blades.....	324
Changing the Rear Wiper Blades.....	324
Changing the Vehicle Wi-Fi Hotspot Name or Password.....	403
Charging a Wireless Device.....	155
Checking Local Hazard Information Status.....	271
Checking MyKey System Status.....	197
Checking the Clutch Fluid Level.....	61
Checking the Wiper Blades.....	83
Child Restraint Positioning.....	37
Child Safety.....	33
Child Safety Locks.....	42
Left-Hand Side.....	42
Right-Hand Side.....	42
Cigar Lighter.....	154
Cleaning the Exterior.....	334
Cleaning Camera Lenses and Sensors.....	335
Cleaning Chrome, Aluminium or Stainless Steel.....	334
Cleaning Headlamps and Rear Lamps.....	334
Cleaning Stripes or Graphics.....	335
Cleaning the Engine Compartment.....	335
Cleaning the Exterior Precautions.....	334
Cleaning the Underbody.....	335
Cleaning Wheels.....	334
Cleaning Windows and Wiper Blades.....	334
Cleaning the Interior.....	335
Cleaning Carpets and Floor Mats.....	337
Cleaning Displays and Screens.....	336
Cleaning Fabric Seats and Headliners.....	336
Cleaning Leather and Vinyl.....	336
Cleaning Moonroof Tracks.....	337
Cleaning Plastic.....	336

Index

Cleaning Seatbelts.....	337	Switching the Heated Steering Wheel On and Off.....	429	Connected Vehicle – Troubleshooting - Vehicles With: Modem.....	400
Cleaning Storage Compartments.....	337	Switching the Heated Windshield On and Off.....	429	Connected Vehicle – Troubleshooting - Vehicles With: SYNC 3/SYNC 2.5.....	401
Clearing the Instrument Panel.....	335	Switching the Rear Climate Controlled Seats On and Off.....	430	Connecting a Bluetooth® Device - Vehicles With: SYNC 2.5.....	407
Clearing All MyKeys.....	60	Switching the Rear Heated Seats On and Off.....	430	Connecting the Vehicle to a Mobile Network.....	399
Climate.....	427	Switching the Rear Ventilated Seats On and Off.....	430	Connecting FordPass to the Modem.....	399
Accessing Rear Climate Controls.....	429	Switching the Ventilated Seats On and Off.....	429	Enabling and Disabling the Modem.....	399
Accessing the Climate Control Menu.....	427	Climate Control.....	139	What Is the Modem.....	399
Directing the Airflow.....	427	Climate Control – Troubleshooting.....	140	Connecting the Vehicle to a Wi-Fi Network.....	399
Rear Climate Control Lock Indicator.....	430	Climate Control – Troubleshooting.....	140	Coolant Check	
Setting the Blower Motor Speed.....	428	Climate Control – Frequently Asked Questions.....	140	See: Engine Coolant Check.....	320
Setting the Temperature.....	428	Clutch Fluid Check.....	322	Cornering Lamps.....	95
Switching Auto Mode On and Off.....	428	Clutch Fluid Specification.....	197	Crash and Breakdown Information.....	289
Switching Dual Zone Mode On and Off.....	428	Cold Weather Precautions.....	282	Post-Crash Alert System.....	289
Switching Maximum Air Conditioning On and Off.....	429	Compact Disc Player – Vehicles With: SYNC 2.5.....	407	Post Impact Braking.....	289
Switching Maximum Defrost On and Off.....	429	Playing a CD.....	408	Creating a MyKey - Vehicles With: Push Button Start.....	60
Switching Rear Auto Mode On and Off.....	430	Using the CD Player.....	408	Creating a MyKey - Vehicles Without: Push Button Start.....	60
Switching Recirculated Air On and Off.....	429	Connected Vehicle.....	399	Creating a Vehicle Wi-Fi Hotspot.....	403
Switching the Air Conditioning On and Off.....	428	Connecting the Vehicle to a Mobile Network.....	399	Connecting a Device to the Wi-Fi Hotspot.....	403
Switching the Climate Controlled Seats On and Off.....	428	Connected Vehicle Data - Vehicles With: Modem.....	18	Finding the Wi-Fi Hotspot Name and Password.....	403
Switching the Climate Control On and Off.....	428	Connected Vehicle Limitations.....	399	Cross Traffic Alert.....	254
Switching the Heated Exterior Mirrors On and Off.....	428	Connected Vehicle Requirements.....	399	Cross Traffic Alert Indicator.....	257
Switching the Heated Rear Window On and Off.....	429			Cross Traffic Alert Information Messages.....	258
Switching the Heated Seats On and Off.....	429				

Index

Cross Traffic Alert System Limitations.....	257	Door Lock Indicators.....	69	Sport.....	268
Cross Traffic Alert System Sensors.....	256	Door Lock Switch Inhibitor.....	68	Track.....	268
Switching Cross Traffic Alert On or Off.....	257	How Does the Door Lock Switch Inhibitor Work.....	68	Trail.....	268
Using Cross Traffic Alert.....	254	Doors and Locks Audible Warnings.....	69	Driver Airbag.....	46
Cruise Control.....	220	Door Ajar Audible Warning.....	69	Driver Alert.....	246
Principle of Operation.....	220	Doors and Locks.....	65	Resetting the System.....	248
Cruise control		Autolock.....	68	System Display.....	247
See: Using Cruise Control.....	220	Autorelock.....	69	System Warnings.....	247
Cup Holders.....	157	Autounlock.....	68	Driving Aids.....	243
D		Door Lock Switch Inhibitor.....	68	Driving Economically.....	282
Data Privacy.....	16	Doors and Locks – Troubleshooting.....	69	Driving Hints.....	282
Services That Third Parties Provide.....	16	Mislock.....	68	Driving Through Shallow Water.....	283
Services That We Provide.....	16	Operating the Doors From Inside Your Vehicle.....	67	E	
Declaration of Conformity.....	483	Operating the Doors From Outside Your Vehicle.....	65	Eco.....	262
Device Holder.....	157	Doors and Locks – Troubleshooting.....	69	Eco Mode.....	262
Installing a Device.....	157	Doors and Locks – Information		Efficient Drive Mode.....	270
Installing the Device Holder.....	157	Messages.....	70	Trip Summary.....	270
Removing a Device.....	157	Doors and Locks – Warning Lamps.....	69	Efficient Drive Mode Indicators.....	270
Removing the Device Holder.....	157	Drive Mode Control.....	268	Electromagnetic Compatibility.....	452
Diesel Particulate Filter.....	193	Drive Mode Control – Troubleshooting.....	269	Emergency Assistance.....	50
Diesel Particulate Filter Automatic		Drive Modes.....	268	Emergency Call System Data.....	19
Regeneration.....	194	Drive Mode Control – Troubleshooting.....	269	Enabling Local Hazard Information.....	271
On-Board Diagnostics System.....	194	Drive Mode Control – Information		Enabling Remote Start.....	137
Digital Radio - Vehicles With: SYNC		Messages.....	269	End User License Agreement.....	456
2.5.....	406	Drive Modes.....	268	VEHICLE SOFTWARE END USER LICENSE	
Using the Radio.....	406	Eco.....	268	AGREEMENT (EULA)	456
Direction Indicators.....	96	Normal.....	268	Engine Block Heater.....	162
Displaying the Efficient Drive Mode.....	270	Slippery.....	268	Engine Block Heater Precautions.....	162
Door Edge Protection.....	78			How Does the Engine Block Heater Work.....	162
Principle of Operation.....	78				

Index

Using the Engine Block Heater.....	162
Engine Coolant Check.....	320
Adding Coolant.....	321
Engine Cooling Fan - Diesel.....	320
Engine Cooling Fan - Gasoline.....	320
Engine Emission Control.....	191
Engine Immobilizer	
See: Passive Anti-Theft System.....	75
Engine Oil Check.....	317
Adding Engine Oil.....	318
Engine Oil Dipstick - 1.0L EcoBoost™/1.1L Duratec.....	317
Engine Oil Dipstick - 1.5L Duratorq-TDCI Diesel.....	317
Engine Oil Dipstick - 1.5L EcoBoost™.....	317
Engine Overspeed.....	282
Entertainment.....	425
Playing Music From a USB or Media Player.....	427
Streaming Music From a Bluetooth Device.....	426
Using the Radio.....	425
Environment.....	20
Event Data.....	17
Exterior Mirrors.....	103
F	
Fan	
See: Engine Cooling Fan - Diesel.....	320
See: Engine Cooling Fan - Gasoline.....	320
Fastening the Seatbelts.....	43
Using Seatbelts During Pregnancy.....	43
First Aid Kit.....	285
Flat Tire	
See: Changing a Road Wheel - Vehicles With: Spare Wheel.....	345
Flat Tire Inflation	
See: Tire Sealant and Inflator Kit - Vehicles With: Temporary Mobility Kit.....	339
Floor Mats.....	283
Fog Lamps - Front	
See: Front Fog Lamps.....	94
Fog Lamps - Rear	
See: Rear Fog Lamps.....	94
Folding the Exterior Mirrors - Vehicles With: Manual Fold Exterior Mirrors.....	103
Folding the Exterior Mirrors - Vehicles With: Power Fold Exterior Mirrors.....	103
Switching Auto-fold On and Off.....	103
Front Fog Lamps.....	94
Front Fog Lamp Indicator.....	94
Switching the Front Fog Lamps On or Off.....	94
Front Parking Aid.....	210
Front Parking Aid Information Messages.....	212
Object Distance Indicator.....	211
Front Wiper Blades	
See: Changing the Front Wiper Blades.....	324
Fuel and Refueling.....	183
Fuel Consumption Figures - 1.0L EcoBoost™.....	392
Fuel Consumption Figures - 1.1L Duratec.....	393
Fuel Consumption Figures - 1.5L EcoBoost™.....	394
Fuel Consumption Figures.....	395
European Directive 1999/94/EC.....	395
Fuel Economy and CO2 Emissions.....	395
Fuel Consumption.....	189
Advertised Capacity.....	189
Fuel Economy.....	190
Fuel Filler Funnel Location.....	185
Fuel Quality - Diesel.....	185
Long-Term Storage.....	185
Fuel Quality - E85.....	183
Choosing the Right Fuel - Flex Fuel Vehicles.....	183
Long-Term Storage.....	184
Fuel Quality - Gasoline.....	184
Long-Term Storage.....	185
Fuel Shutoff.....	285
Fuse Box Locations.....	290
Engine Compartment Fuse Box.....	290
Passenger Compartment Fuse Box.....	290
Fuses.....	290
Fuse Specification Chart.....	291
Engine Compartment Fuse Box.....	291
Passenger Compartment Fuse Box.....	299

Index

G

Gasoline Particulate Filter.....	192
Gasoline Particulate Filter Information	
Messages.....	193
Gasoline Particulate Filter	
Regeneration.....	192
Gasoline Particulate Filter Warning Lamps	
and Indicators.....	192
Gauges - Excluding: Mild Hybrid Electric	
Vehicle (MHEV).....	105
Automatic Transmission Position	
Indicators.....	107
Engine Coolant Temperature Gauge.....	107
Fuel Gauge.....	106
Information Display.....	106
Instrument Cluster.....	105
Speedometer.....	106
Tachometer.....	106
Gauges - Mild Hybrid Electric Vehicle	
(MHEV).....	108
Automatic Transmission Gearshift Lever	
Position Indicator.....	110
Engine Coolant Temperature Gauge.....	110
Fuel Gauge.....	109
Hybrid Gauge.....	110
Information Display.....	109
Instrument Cluster.....	108
Speedometer.....	109
Tachometer.....	109
General Information on Radio	
Frequencies.....	53

Global Opening and Closing.....	99
Switching Global Closing On and Off.....	100
Switching Global Opening On and Off.....	100
Using Global Closing.....	100
Using Global Opening.....	99
What Is Global Opening and Closing.....	99

H

Handbrake	
See: Parking Brake - Automatic	
Transmission.....	204
See: Parking Brake - Manual	
Transmission.....	203
Hazard Flashers.....	285
Hazard Flasher Indicator.....	285
Switching the Hazard Flashers On or	
Off.....	285
Headlamp Exit Delay.....	91
Headlamp Leveling.....	94
Headlamp Removal	
See: Removing a Headlamp.....	325
Headrest	
See: Head Restraints.....	145
Head Restraints.....	145
Adjusting the Head Restraints.....	146
Removing the Head Restraints.....	146
Heated Seats.....	151
Heated Steering Wheel.....	80

Heating	
See: Climate Control - Vehicles With: Automatic	
Temperature Control.....	139
See: Climate Control - Vehicles With: Manual	
Temperature Control.....	142
Hill Start Assist.....	204
Switching the System On and Off.....	205
Using Hill Start Assist.....	205
Hints on Driving With Anti-Lock	
Brakes.....	203
Hood Lock	
See: Opening and Closing the Hood.....	304
How Does the Rear Occupant Alert System	
Work.....	152
Hybrid Vehicle Operation.....	174

I

Ignition Switch.....	158
Starting the Engine.....	158
Switching the Ignition Off.....	158
Switching the Ignition On.....	158
Switching the Ignition to Accessory	
Mode.....	158
Information Displays.....	116
General Information.....	116
Information Messages.....	121
Active Park Assist.....	121
Adaptive Cruise Control.....	122
Alarm.....	122
Automatic High Beam Control.....	123
Auto-Start-Stop.....	123

Index

Blind Spot Information and Cross Traffic Alert Systems.....	124
Brake System.....	125
Doors and Locks.....	126
Driver Alert.....	126
Engine.....	127
Fuel System.....	127
Headlamps.....	128
Hill Start Assist.....	128
Lane Keeping System.....	128
Maintenance.....	129
MyKey.....	130
Parking Aid.....	131
Parking Brake.....	131
Pre-Collision Assist.....	132
Rear Window Lock.....	132
Remote Control.....	132
Seatbelt Reminder.....	132
Selectable Drive Modes.....	133
Stability Control.....	133
Starting System.....	133
Steering System.....	134
Tire Pressure Monitoring System.....	135
Transmission.....	135
Installing Child Restraints.....	33
Attaching a Child Restraint With a Support Leg.....	36
Attaching a Child Restraint With Top Tethers.....	36
Booster Seats.....	34
Child Restraints for Different Mass Groups.....	34
ISOFIX Anchor Points.....	35
Top Tether Anchor Points.....	36
Instrument Cluster.....	105
Instrument Lighting Dimmer.....	91
Instrument Panel - LHD.....	22
Instrument Panel - RHD.....	24
Intelligent Speed Limiter.....	243
Adjusting Intelligent Speed Limiter Tolerance Settings.....	245
Principle of Operation.....	243
Switching to Normal Speed Limiter.....	246
Using Intelligent Speed Limiter.....	244
Interior Lamps - Vehicles With: Front Interior Lamp.....	96
Interior Lamp Function.....	97
Switching All of the Interior Lamps On and Off.....	96
Switching the Rear Interior Lamps On and Off.....	96
Interior Lamps - Vehicles With: Front Interior Lamp With Map Reading Lamps.....	97
Interior Lamp Function.....	98
Switching All of the Interior Lamps On and Off.....	97
Switching the Front Interior Lamps On and Off.....	97
Switching the Rear Interior Lamps On and Off.....	97
Interior Mirror.....	102
Auto-Dimming Interior Mirror.....	102
Intermittent Wipe.....	81
Setting the Intermittent Wipe Interval.....	82
Switching Intermittent Wipe On and Off.....	81
Introduction.....	11
J	
Jump Starting the Vehicle.....	286
To Connect the Booster Cables.....	287
To Start the Engine.....	287
K	
Keyless Entry.....	71
Keyless Entry Settings.....	71
Keyless Entry – Troubleshooting.....	73
Locking and Unlocking the Doors Using Keyless Entry.....	72
Locking and Unlocking the Liftgate Using Keyless Entry.....	72
Keyless Entry Limitations.....	71
Keyless Entry Settings.....	71
Reprogramming the Unlocking Function.....	71
Switching Keyless Entry On and Off.....	71
Keyless Entry – Troubleshooting.....	73
Keyless Entry – Frequently Asked Questions.....	73
Keys and Remote Controls.....	53

Index

L

Lane Keeping System.....	248
Lane Keeping System Display.....	250
Lane Keeping System Indicators.....	250
Lane Keeping System Messages.....	251
Lane Keeping System Settings.....	249
Lane Keeping System Warning Lamp.....	251
Switching Lane Keeping System On and Off.....	249
Liftgate.....	74
Lighting Control.....	88
Exterior Lamps On Audible Warning.....	90
Flashing High Beam Headlamps.....	90
Headlamps Information Messages.....	90
High Beam Headlamp Indicator.....	90
Lamps On Indicator.....	90
Lighting Control Positions.....	88
Low Beam Headlamp Warning Lamp.....	90
Switching All of the Parking Lamps On.....	89
Switching High Beam Headlamps On and Off.....	89
Switching the Left-Hand Side or the Right-Hand Side Parking Lamps On.....	89
Lighting.....	88
General Information.....	88
Load Carriers	
See: Roof Racks and Load Carriers - Vehicles With: Panoramic Roof Opening Panel.....	274
See: Roof Racks and Load Carriers - Vehicles Without: Panoramic Roof Opening Panel.....	273

Load Carrying.....	272
General Information.....	272
Local Hazard Information.....	271
Local Hazard Information Precautions.....	271
Locating the Washer Fluid Reservoir.....	86
Locating the Wireless Accessory Charger.....	155
Locking and Unlocking the Doors Using Keyless Entry.....	72
Double Locking the Doors.....	72
Locking the Doors.....	72
Unlocking the Doors.....	72
Locking and Unlocking the Liftgate Using Keyless Entry.....	72
Locking the Liftgate.....	73
Unlocking the Liftgate.....	72
Locking the Rear Window Controls.....	101
Locking the Steering Wheel - Vehicles With: Push Button Start.....	79
Unlocking the Steering Wheel.....	80
Locking the Steering Wheel - Vehicles Without: Push Button Start.....	79
Unlocking the Steering Wheel.....	79
Luggage Covers.....	273
Removing the Cover.....	273
Lug Nuts	
See: Changing a Road Wheel - Vehicles With: Spare Wheel.....	345
Lug Nuts.....	371
Locking Lug Nuts.....	371
Lug Nut Torque.....	371

M

Maintenance.....	304
General Information.....	304
Manual Liftgate.....	74
Closing the Liftgate.....	74
Opening the Liftgate Using the Exterior Release Button.....	74
Opening the Liftgate Using the Remote Control.....	74
Manually Shifting Gears.....	200
Shifting Using the Paddle Shifters.....	200
Manual Seats - 3-Door.....	146
Adjusting the Height of the Driver Seat.....	148
Adjusting the Lumbar Support.....	148
Folding the Seat Backrest Forward.....	147
Moving the Seat Backward and Forward.....	147
Recline Adjustment.....	149
Returning the Seat Backrest to the Seating Position.....	148
Manual Seats - 5-Door.....	149
Adjusting the Height of the Driver Seat.....	150
Adjusting the Lumbar Support.....	149
Moving the Seat Backward and Forward.....	149
Recline Adjustment.....	150
Manual Transmission.....	197
Manual Transmission - Troubleshooting.....	198
Manual Transmission Precautions.....	197
Manual Transmission Shift Indicators.....	197

Index

Manual Transmission – Troubleshooting.....	198
Manual Transmission – Frequently Asked Questions.....	198
Message Center See: Information Displays.....	116
Mislock.....	68
How Does Mislock Work.....	69
Mislock Limitations.....	69
Switching Mislock On and Off.....	69
What Is Mislock.....	68
Mobile Communications Equipment.....	14
Mobile Device Data - Vehicles With: SYNC 3.....	18
Moonroof Bounce-Back.....	104
Moonroof.....	104
MyKey Settings.....	59
Configurable MyKey Settings.....	59
Non-Configurable MyKey Settings.....	59
MyKey – Troubleshooting.....	61
MyKey – Frequently Asked Questions.....	63
MyKey – Information Messages.....	61
MyKey™.....	59
MyKey Settings.....	59
MyKey – Troubleshooting.....	61
N	
Navigation.....	432
Changing the Format of the Map.....	434
Live Traffic.....	436
Navigation Map Updates.....	437

Route Guidance.....	434
Setting a Destination.....	433
Zoom.....	434

O

Oil Change Indicator Reset.....	318
Oil Check See: Engine Oil Check.....	317
Opening and Closing the Hood.....	304
Closing the Hood.....	305
Opening the Hood.....	304
Opening and Closing the Moonroof.....	104
Closing the Moonroof.....	104
Opening the Moonroof.....	104
Opening and Closing the Sun Shade.....	104
Opening and Closing the Windows.....	99
One-Touch Close.....	99
One-Touch Open.....	99
Operating the Doors From Inside Your Vehicle.....	67
Unlocking and Locking the Doors Using the Central Locking.....	67
Operating the Doors From Outside Your Vehicle.....	65
Double Locking the Doors Using the Key Blade.....	66
Double Locking the Doors Using the Remote Control.....	66
Individually Unlocking and Locking the Doors Using the Key Blade.....	66

Unlocking and Locking the Doors Using the Key Blade.....	65
Unlocking and Locking the Doors Using the Remote Control.....	65

P

Parking Aids.....	208
Principle of Operation.....	208
Parking Brake - Automatic Transmission.....	204
Parking Brake - Manual Transmission.....	203
Passenger Airbag.....	47
Passive Anti-Theft System.....	75
Arming the Engine Immobilizer.....	75
Coded Keys.....	75
Disarming the Engine Immobilizer.....	75
Principle of Operation.....	75
Passive Key Backup Position.....	58
PATS See: Passive Anti-Theft System.....	75
Personalized Settings.....	119
Chimes.....	121
Language.....	119
Measure Unit.....	120
Temperature Unit.....	120
Tire Pressure Unit.....	120
Phone.....	430
Android Auto.....	432
Apple CarPlay.....	432

Index

Pairing Your Cell Phone for the First Time.....	430	Push Button Ignition Switch.....	159	Rear View Camera.....	217
Text Messaging.....	431	Starting the Engine.....	159	Enhanced Parking Aids or Park Pilot.....	219
Using Your Cell Phone.....	431	Switching the Ignition Off.....	159	Using the Rear View Camera.....	217
Playing Media From a USB Device - Vehicles With: SYNC 2.5.....	408	Switching the Ignition to Accessory Mode.....	159	Rear View Camera See: Rear View Camera.....	217
Selecting the USB Device.....	408	R		Rear Wiper Blades See: Changing the Rear Wiper Blades.....	324
Supported File Formats.....	408	REACH.....	13	Refueling.....	187
Post-Crash Alert System.....	289	Rear Fog Lamps.....	94	Refueling System Overview.....	187
How Does the Post-Crash Alert System Work.....	289	Rear Fog Lamp Indicator.....	94	Refueling System Warning.....	189
Post-Crash Alert System Limitations.....	289	Switching the Rear Fog Lamps On or Off.....	94	Refueling Your Vehicle.....	187
Switching the Post-Crash Alert System Off.....	289	Rear Lamp Removal See: Removing a Rear Lamp.....	326	Remote Control - Vehicles With: Keyless Entry.....	53
What Is the Post-Crash Alert System.....	289	Rear Occupant Alert System Audible Warnings.....	153	Changing the Remote Control Battery.....	54
Post Impact Braking.....	289	Rear Occupant Alert System Indicators.....	153	Locating Your Vehicle.....	55
How Does Post Impact Braking Work.....	289	Rear Occupant Alert System Limitations.....	152	Passive Key.....	53
Overriding Post Impact Braking.....	289	Rear Occupant Alert System Precautions.....	152	Remote Control Information Messages.....	55
Post Impact Braking Indicators.....	289	Rear Occupant Alert System Object Distance Indicator.....	209	Remote Control - Vehicles With: Remote Flip Key.....	56
Post Impact Braking Limitations.....	289	Rear Parking Aid.....	208	Changing the Remote Control Battery.....	56
Pre-Collision Assist.....	262	Object Distance Indicator.....	209	Locating Your Vehicle.....	57
Distance Alert.....	264	Rear Parking Aid Information Messages.....	210	Remote Control Information Messages.....	58
Distance Indication.....	265	Rear Seats.....	150	Remotely Starting and Stopping the Vehicle.....	137
Pre-Collision Assist Information Messages.....	267	Folding the Seat Backrest.....	150	Remote Start Limitations.....	137
Pre-Collision Assist System Sensors.....	266	Unfolding the Seat Backrest.....	151	Remote Start.....	137
Pre-Collision Assist Warning Lamp.....	266	Rear Under Floor Storage.....	272	Remote Start Settings - Vehicles With: Heated Steering Wheel.....	138
Programming a MyKey.....	60	Adjustable Load Floor.....	272	Climate Control Settings.....	138
Protecting the Environment.....	20			Heated Seat and Steering Wheel Settings.....	138
Puncture See: Changing a Road Wheel - Vehicles With: Spare Wheel.....	345			Setting the Remote Start Duration.....	138

Index

Remote Start Settings - Vehicles Without:		
Heated Steering Wheel.....	137	
Climate Control Settings.....	137	
Heated Seat Settings.....	138	
Setting the Remote Start Duration.....	138	
Removing a Headlamp.....	325	
Removing a Rear Lamp.....	326	
Brake Lamp, Rear Lamp and Direction Indicator.....	326	
Reversing Lamp.....	327	
Repairing Minor Paint Damage.....	337	
Replacement Parts Recommendation.....	14	
Collision Repairs.....	14	
Scheduled Maintenance and Mechanical Repairs.....	14	
Warranty on Replacement Parts.....	14	
Replacing a Lost Key or Remote Control.....	58	
Replacing the Front Wiper Blades.....	84	
Replacing the Rear Wiper Blades.....	84	
Reprogramming the Unlocking Function.....	67	
Resetting Tire Pressure Monitoring System.....	372	
Restarting the Engine.....	176	
Restarting the Engine in Gear.....	176	
Restarting the Engine in Neutral.....	176	
Roadside Emergencies.....	285	
Roof Racks and Load Carriers - Vehicles With: Panoramic Roof Opening		
Panel.....	274	
Towbar Carriers.....	274	
Roof Racks and Load Carriers - Vehicles Without: Panoramic Roof Opening		
Panel.....	273	
Tow Bar Carriers.....	273	
Running-In		
See: Breaking-In.....	282	
Running Out of Fuel.....	185	
Adding Fuel From a Portable Fuel Container.....	186	
Filling a Portable Fuel Container.....	186	
S		
Safety Precautions.....	183	
Seatbelt Reminder.....	44	
Fasten Seatbelt Audible Warning.....	44	
Fasten Seatbelt Warning Lamp.....	44	
Seatbelt Status.....	44	
Seatbelts.....	43	
Seats.....	145	
Security.....	75	
Selecting a Drive Mode - Excluding: ST.....	268	
Service Data.....	17	
Settings Data.....	18	
Comfort and Convenience Data.....	18	
Entertainment Data.....	18	
Settings.....	438	
Ambient Lighting.....	438	
Android Auto.....	438	
Apple CarPlay.....	438	
Audio.....	438	
Automatic Updates.....	438	
Bluetooth.....	439	
Clock.....	439	
Display.....	439	
Emergency Assistance.....	439	
FordPass.....	439	
General.....	439	
Mobile Apps.....	439	
Navigation.....	439	
Phone.....	439	
Seats.....	439	
Sound.....	439	
Valet Mode.....	439	
Vehicle.....	439	
Voice Control.....	439	
Wi-Fi.....	439	
Setting the Blower Motor Speed.....	140	
Setting the Temperature.....	140	
Shifting Into Reverse - 5-Speed Manual Transmission.....	197	
Shifting Into Reverse - 6-Speed Manual Transmission.....	197	
Side Airbags.....	48	
Side Curtain Airbags.....	49	
Side Sensing System.....	212	
Object Distance Indicator.....	213	
Sitting in the Correct Position.....	145	
Snow Chains		
See: Using Snow Chains.....	345	
Spare Wheel		
See: Changing a Road Wheel - Vehicles With: Spare Wheel.....	345	

Index

Speed Control		
See: Cruise Control.....	220	
Speed Limiter.....	243	
Principle of Operation.....	243	
Using Speed Limiter.....	243	
Speed Sign Recognition.....	260	
Principle of Operation.....	260	
Speed Sign Recognition System Display.....	261	
Speed Sign Recognition System Messages.....	261	
Using Speed Sign Recognition.....	260	
Stability Control.....	207	
Principle of Operation.....	207	
Starter Switch		
See: Ignition Switch.....	158	
Starting and Stopping the Engine – Precautions.....	158	
Starting and Stopping the Engine.....	158	
Automatic Engine Stop.....	165	
Engine Block Heater.....	162	
Starting and Stopping the Engine – Troubleshooting.....	166	
Starting the Engine.....	159	
Stopping the Engine.....	163	
Starting and Stopping the Engine – Troubleshooting.....	166	
Starting and Stopping the Engine – Frequently Asked Questions.....	168	
Starting and Stopping the Engine – Information Messages.....	167	
Starting and Stopping the Engine – Warning Lamps.....	166	
Starting the Engine.....	159	
Restarting the Engine After Stopping it.....	161	
Starting a Diesel Engine.....	160	
Starting a Gasoline Engine.....	159	
Steering Wheel - Excluding: ST.....	21	
Steering Wheel.....	79	
Steering Wheel - ST.....	21	
Stopping the Engine.....	175	
Stopping the Engine in Gear.....	175	
Stopping the Engine in Neutral.....	175	
Stopping the Engine When Your Vehicle is Moving.....	164	
Stopping the Engine When Your Vehicle is Stationary.....	163	
Storage Compartments.....	157	
Streaming Bluetooth Audio - Vehicles With: SYNC 2.5.....	408	
Sunroof		
See: Moonroof.....	104	
Supplementary Restraints System.....	46	
Principle of Operation.....	46	
Switching Air Conditioning On and Off.....	139	
Switching Auto-Start-Stop On and Off.....	175	
Switching Climate Control On and Off.....	139	
Switching Efficient Drive Mode On and Off.....	270	
Switching Maximum Cooling On and Off.....	139	
Switching Maximum Defrost On and Off.....	139	
Switching Rear Occupant Alert System On and Off.....	153	
Semiannual Reminder.....	153	
Switching Recirculated Air On and Off.....	139	
Switching Reverse Wipe On and Off.....	83	
Switching the Courtesy Wipe On and Off.....	85	
Switching the Heated Mirrors On and Off.....	140	
Switching the Heated Rear Window On and Off.....	139	
Switching the Heated Windshield On and Off.....	139	
Switching the Passenger Airbag On and Off.....	47	
Switching the Passenger Airbag Off.....	47	
Switching the Passenger Airbag On.....	47	
Switching the Rear Window Wiper On and Off.....	83	
Switching Windshield Wipers On and Off.....	81	
Symbols Glossary.....	11	
SYNC™ 3.....	415	
General Information.....	415	
SYNC™ 3 Troubleshooting.....	440	
Additional Information and Assistance.....	451	
Apps.....	448	
Navigation.....	447	
Phone.....	445	

Index

Resetting the System.....	451	Tire Pressures - 1.5L Diesel.....	364	Towing.....	275
USB and Bluetooth Audio.....	442	Temporary Spare Wheel.....	368	Traction Control.....	206
Voice Recognition.....	440	Tire Pressures - 1.5L EcoBoost™.....	368	Principle of Operation.....	206
Wi-Fi Connectivity.....	450	Temporary Spare Wheel.....	370	Traffic Sign Recognition.....	258
T		Tire Pressures.....	360	Principle of Operation.....	258
Technical Specifications		Temporary Spare Wheel.....	364	Setting the Speed Warning.....	259
See: Capacities and Specifications.....	375	Tire Repair Kit		Switching Speed Warning On and Off.....	259
Tire Care.....	343	See: Tire Sealant and Inflator Kit - Vehicles With:		Traffic Sign Recognition System	
Tire Inflation When Punctured		Temporary Mobility Kit.....	339	Display.....	259
See: Tire Sealant and Inflator Kit - Vehicles With:		Tire Sealant and Inflator Kit - Vehicles		Traffic Sign Recognition System	
Temporary Mobility Kit.....	339	With: Temporary Mobility Kit.....	339	Messages.....	260
Tire Pressure Monitoring System		After Using the Tire Sealant and Inflator		Trip Computer.....	117
Limitations.....	372	Kit.....	343	Average Fuel.....	119
Tire Pressure Monitoring System		Using the Tire Sealant and Inflator Kit.....	340	Average Speed.....	119
Precautions.....	372	Tires		Distance to Empty.....	119
Tire Pressure Monitoring System.....	372	See: Wheels and Tires.....	339	Instantaneous Fuel.....	119
Tire Pressure Monitoring System –		Tow Ball.....	276	Personalization.....	118
Troubleshooting.....	373	Attaching the Tow Ball Arm.....	277	Resetting the Trip Computer.....	117
Tire Pressure Monitoring System –		Detaching the Tow Ball Arm.....	276	Trip Odometer.....	119
Troubleshooting.....	373	Quickly Detaching the Tow Ball Arm.....	278	Trip Timer.....	119
Tire Pressure Monitoring System – Information		Tow Ball Arm Guidelines.....	279	Trip Summary.....	270
Messages.....	374	Towbar Dimensions.....	376	How Does Trip Summary Work.....	270
Tire Pressure Monitoring System – Warning		Towing a Trailer - Excluding: ST.....	275	Viewing the Trip Summary.....	270
Lamps.....	373	Towing a Trailer - ST.....	276		
Tire Pressures - 1.0L EcoBoost™,		Towing Points.....	287	U	
Automatic Transmission.....	356	Front Towing Point.....	287	Under Hood Overview - 1.0L EcoBoost™,	
Temporary Spare Wheel.....	360	Rear Towing Point.....	288	LHD.....	306
Tire Pressures - 1.0L EcoBoost™, Manual		Towing the Vehicle on Four Wheels -		Under Hood Overview - 1.0L EcoBoost™,	
Transmission.....	353	Automatic Transmission.....	280	RHD.....	308
Temporary Spare Wheel.....	356	Emergency Towing.....	280	Under Hood Overview - 1.1L Duratec,	
		Towing the Vehicle on Four Wheels -		LHD.....	309
		Manual Transmission.....	279		

Index

Under Hood Overview - 1.1L Duratec, RHD.....	310	Setting the Gap Distance.....	223	Setting the Gap Distance.....	234
Under Hood Overview - 1.5L Duratorq-TDCi Diesel, LHD.....	311	Switching Adaptive Cruise Control Off.....	225	Switching Adaptive Cruise Control Off.....	236
Under Hood Overview - 1.5L Duratorq-TDCi Diesel, RHD.....	313	Switching Adaptive Cruise Control On.....	221	Switching Adaptive Cruise Control On.....	232
Under Hood Overview - 1.5L EcoBoost™, LHD.....	314	Switching Between the Cruise Control Modes.....	229	Switching Between the Cruise Control Modes.....	240
Under Hood Overview - 1.5L EcoBoost™, RHD.....	316	Switching to Normal Cruise Control.....	227	Switching to Normal Cruise Control.....	239
Unique Driving Characteristics.....	171	System Not Available.....	225	System Not Available.....	237
USB Port.....	409	Using Adaptive Cruise Control - Vehicles With: Adaptive Cruise Control With Stop and Go.....	232	Using Cruise Control.....	220
Using Adaptive Cruise Control - Vehicles With: Adaptive Cruise Control.....	221	Adaptive Cruise Control Indicator.....	239	Canceling the Set Speed.....	220
Adaptive Cruise Control Indicator.....	228	Adaptive Cruise Control Information Messages.....	240	Changing the Set Speed.....	220
Adaptive Cruise Control Information Messages.....	229	Adaptive Cruise Control System Sensors.....	237	Cruise Control Indicator.....	221
Adaptive Cruise Control System Sensors.....	226	Adaptive Cruise Control With Speed Sign Recognition.....	240	Resuming the Set Speed.....	220
Adaptive Cruise Control With Speed Sign Recognition.....	229	Adaptive Cruise Control With Speed Sign Recognition Information Messages.....	242	Setting the Cruise Speed.....	220
Adaptive Cruise Control With Speed Sign Recognition Information Messages.....	231	Automatic Cancellation.....	236	Switching Cruise Control Off.....	220
Automatic Cancellation.....	224	Canceling the Set Speed.....	235	Switching Cruise Control On.....	220
Canceling the Set Speed.....	224	Changing the Set Speed.....	235	Using MyKey With Remote Start Systems.....	61
Changing the Set Speed.....	224	Detection Issues.....	236	Using Snow Chains.....	345
Detection Issues.....	225	Following a Vehicle.....	233	Using Stability Control.....	207
Following a Vehicle.....	222	Following a Vehicle to a Complete Stop.....	234	Using Traction Control.....	206
Hilly Condition Usage.....	224	Hilly Condition Usage.....	236	Switching the System On and Off.....	206
Overriding the System.....	224	Overriding the System.....	235	Using Voice Recognition.....	412
Resuming the Set Speed.....	224	Resuming the Set Speed.....	236	Apps.....	423
Setting the Adaptive Cruise Speed.....	222	Setting the Adaptive Cruise Speed.....	233	Automatic Blower Motor Speed Reduction.....	425
		Setting the Adaptive Cruise Speed When Your Vehicle is Stationary.....	233	Entertainment.....	418
				General.....	417
				Navigation.....	422
				Phone.....	420
				Phone Voice Service.....	412
				Voice Settings.....	424
				Using Winter Tires.....	344

Index

V		
Vehicle Care.....	334	
Cleaning the Exterior.....	334	
Cleaning the Interior.....	335	
Vehicle Dimensions.....	375	
Vehicle Identification Number.....	396	
Locating the Vehicle Identification Number.....	396	
Vehicle Identification Plate.....	396	
Locating the Vehicle Identification Plate.....	396	
Vehicle Identification Plate Overview.....	397	
Vehicle Identification.....	396	
Vehicle Identification Number.....	396	
Vehicle Identification Plate.....	396	
Vehicle Wi-Fi Hotspot.....	403	
Ventilation		
See: Climate Control - Vehicles With: Automatic Temperature Control.....	139	
See: Climate Control - Vehicles With: Manual Temperature Control.....	142	
Venting the Moonroof.....	104	
Viewing the Tire Pressures.....	372	
Visual Search.....	21	
W		
Warning Lamps and Indicators.....	111	
Airbag Warning Lamp.....	111	
Anti-Lock Brake System Warning Lamp.....	111	
Automatic Headlamp High Beam Indicator.....	111	
Auto-Start-Stop Indicator.....	111	
Blind Spot Information System Indicator.....	111	
Brake System Warning Lamp.....	111	
Collision Warning System Indicator.....	112	
Cruise Control Indicator.....	112	
Direction Indicator.....	112	
Door Ajar Warning Lamp.....	112	
Engine Coolant Temperature Warning Lamp.....	112	
Engine Warning Lamps.....	112	
Fasten Seatbelt Warning Lamp.....	112	
Front Fog Lamp Indicator.....	112	
Frost Warning Lamp.....	113	
Glow Plug Indicator.....	113	
Hazard Flasher Indicator.....	113	
Headlamp High Beam Indicator.....	113	
Headlamp Low Beam Warning Lamp.....	113	
Ignition Warning Lamp.....	113	
Lamps on Indicator.....	113	
Lane Keeping Aid Warning Lamp.....	113	
Lane Keeping Alert Indicator.....	113	
Launch Control Indicator.....	113	
Low Fuel Level Warning Lamp.....	113	
Low Tire Pressure Warning Lamp.....	113	
Oil Pressure Warning Lamp.....	113	
Over Speed Warning Indicator.....	114	
Performance Shift Indicator.....	114	
Rear Fog Lamp Indicator.....	114	
Shift Indicator.....	114	
Stability Control and Traction Control Indicator.....	114	
Stability Control and Traction Control Off Warning Lamp.....	114	
Warning Triangle.....	285	
Washer Fluid Check.....	324	
Washer Fluid Reservoir Capacity.....	86	
Washer Fluid Specification.....	87	
Washer Precautions.....	85	
Washers.....	85	
Washing the Rear Window.....	85	
Washing the Windshield.....	85	
Waxing Your Vehicle.....	337	
What Is a Connected Vehicle.....	399	
What Is Auto-Start-Stop.....	175	
What Is Drive Mode Control.....	268	
What Is Efficient Drive Mode.....	270	
What Is Local Hazard Information.....	271	
What Is MyKey.....	59	
What Is Remote Start.....	137	
What Is the Rear Occupant Alert System.....	152	
What Is the Tire Pressure Monitoring System.....	372	
Wheel Nuts		
See: Changing a Road Wheel - Vehicles With: Spare Wheel.....	345	
Wheels and Tires.....	339	
General Information.....	339	
Window Bounce-Back.....	100	
Overriding Window Bounce-Back.....	100	
Resetting Window Bounce-Back.....	100	

Index

What Is Window Bounce-Back.....	100
Windows.....	99
Global Opening and Closing.....	99
Window Bounce-Back.....	100
Winter Tires	
See: Using Winter Tires.....	344
Wiper Blades	
See: Checking the Wiper Blades.....	324
Wiper Precautions.....	81
Wipers – Troubleshooting.....	84
Wipers – Frequently Asked Questions.....	84
Wipers.....	81
Autowipers.....	82
Intermittent Wipe.....	81
Wipers – Troubleshooting.....	84
Wireless Accessory Charger	
Indicators.....	156
Wireless Accessory Charger.....	155

